

MicroVAX 3500

VAXserver 3500

digital



MicroVAX 3500 VAXserver 3500 Installation

Order Number EK-O27AB-IN-002

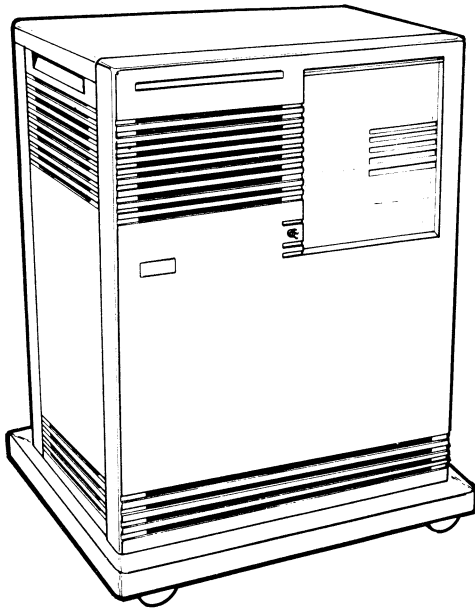

**digital equipment corporation
maynard, massachusetts**

October 1987
July 1988

The information in this document is subject to change without notice and should not be construed as a commitment by Digital Equipment Corporation.

Digital Equipment Corporation assumes no responsibility for any errors that may appear in this document.

The software, if any, described in this document is furnished under a license and may be used or copied only in accordance with the terms of such license. No responsibility is assumed for the use or reliability of software or equipment that is not supplied by Digital Equipment Corporation or its affiliated companies.

Copyright ©1987, 1988 by Digital Equipment Corporation.

All Rights Reserved.
Printed in U.S.A.

The READER'S COMMENTS form on the last page of this document requests the user's critical evaluation to assist in preparing future documentation.

The following are trademarks of Digital Equipment Corporation:

COMPACTape	MASSBUS	ThinWire
DEC	MicroVAX	ULTRIX
DECmate	PDP	UNIBUS
DECnet	P/OS	VAX
DECserver	Professional	VAXcluster
DECUS	Q-bus	VAXELN
DECwriter	Rainbow	VAXlab
DELNI	ReGIS	VMS
DEQNA	RSTS	VT
DESTA	RSX	Work Processor
DIBOL	RT	

ML-S988

FCC NOTICE: The equipment described in this manual generates, uses, and may emit radio frequency energy. The equipment has been type tested and found to comply with the limits for a Class A computing device pursuant to Subpart J of Part 15 of FCC Rules, which are designed to provide reasonable protection against such radio frequency interference when operated in a commercial environment. Operation of this equipment in a residential area may cause interference, in which case the user at his own expense may be required to take measures to correct the interference.

Contents

Preface	v
1 Verify Site Preparation	1
2 Check Your Shipment	1
2.1 Unpack Your Shipment	1
3 Place the System	4
4 Install the Console Terminal	5
4.1 Perform Set-Up Operations	6
4.2 Connect the Console Terminal to the System	7
5 Set Controls on Your System	11
6 Connect Additional Devices to the System	12
6.1 Connect Terminals and Serial Printers	14
6.2 Connect Parallel Printers to the System	17
6.3 Connect Synchronous Modems to the System	18
6.4 Connect Asynchronous Modems to the System	18
6.5 Connect an Internal Modem to Telephone Lines	20
6.6 Connect to an Ethernet Network	28
7 Connect the System Power Cable	29
8 Turn on the System and Select a Language	31
9 Attach the Front Panel to the System	33
10 After Installation	34

Figures

1	Shipping Carton Contents	3
2	Sliding the System into Place	5
3	Connecting a VT300-series Console Terminal	9
4	Connecting a VT200-series Console Terminal	10
5	Front View of MicroVAX 3500	11
6	Connecting Devices to the CXA16 Module	15
7	Connecting Devices to the Cable Concentrator	16
8	Mounting the Cable Concentrator	17
9	Connecting a Modem to a CXY08 Module	19
10	Disconnecting the Telephone Line (Single- and Multi-Line Service)	21
11	Installing Telephone Cord (Single- and Multi-Line Service)	22
12	Connecting Modem to Telephone (Single- and Multi-Line Service)	23
13	Connecting Modem to Wall-Mounted Jack (Data Jack Service)—Telephone-to-Wall-Jack Connection	25
14	Connecting Modem to Wall-Mounted Jack (Data Jack Service)—Telephone-to-DFA01 Connection	27
15	Making a Network Connection	29
16	Power Cords	30
17	Attaching Power Cord to the System	31
18	Language Selection Menu	32
19	Example of a Successful Power-On	33
20	Attaching the Front Panel	34

Tables

1	Module Identification Labels	13
---	--	----

Preface

This manual describes how to install your MicroVAX 3500 or VAXserver 3500 system. It assumes you have unpacked the system according to directions on the shipping carton.

There are two mass storage variations for MicroVAX 3500 systems: RD54-based systems, and RA70-based systems. The illustrations in this manual show the RA70-based system.

Installation includes the following steps:

1. Verifying site preparation
2. Checking your shipment
3. Placing the system
4. Installing the console terminal
5. Setting controls on the system
6. Connecting additional devices to the system
7. Connecting the power cable
8. Turning on the system and selecting a language
9. Attaching the front panel

Before installing a DIGITAL system, review the system warranty. The terms of your warranty agreement with DIGITAL may require that a qualified DIGITAL service representative install your system. Contact your local DIGITAL representative if you have any questions.

NOTE: *VAXserver 3500 systems are designed to offer maximum performance for applications that do not require timesharing. Some of the devices referred to in this manual are designed for multiuser systems and may not be suitable for a VAXserver system. Contact your DIGITAL representative if you have any questions about whether use of a specific device is appropriate for your VAXserver system.*

Conventions

The following conventions are used in this book.

Convention	Meaning
Key	A symbol denoting a terminal key used in text and examples in this book. For example, Break indicates that you press the Break key on your terminal keypad. Return indicates that you press the Return key on your terminal keypad.
WARNING	Provides information to prevent personal injury.
CAUTION	Provides information to prevent damage to equipment or software.
NOTE	Provides general information about the current topic.

1 Verify Site Preparation

Before receiving your system, you should have received a *MicroVAX Site Preparation* manual. This manual describes the physical, environmental, and electrical requirements to operate your system. For your convenience, a copy of this manual is also included in your Customer Hardware Information kit. If you have not already done so, please read the manual and follow its instructions for preparing your site.

The installation instructions that follow assume the site meets all the installation requirements listed in the *MicroVAX Site Preparation* manual. The instructions also assume all terminal data lines, telephone lines, and network lines that you plan to connect to your system are in place and clearly labeled.

2 Check Your Shipment

NOTE: *Save all packing materials if you plan to reship the system.*

Your shipment may include several cartons.

- One contains the system unit with unpacking instructions on the side.
- One contains cables for connecting additional devices to your system.
- Another, with unpacking instructions on the side, contains components of the console terminal.
- Another, marked "Software", contains software documentation, system software, diagnostic software, and a software license.

Depending on your order, your shipment may also include some of the following equipment:

- Additional terminal(s)
- Printer(s)
- Modem(s)

2.1 Unpack Your Shipment

Before installing your system, unpack all cartons and check the contents against the shipping list to ensure you have received everything you ordered.

If any item is missing or damaged:

- Contact your delivery agent.
- Contact your DIGITAL sales representative.

Find the carton containing the system unit and unpack the system according to the instructions on the carton. Figure 1 shows the contents of the shipping carton.

Release the shipping brackets according to the instructions on the yellow label attached to the front of the system unit. When you have completed this, remove the label from the front of the unit.

CAUTION: *Before continuing installation, verify that your system's power requirements match your power source. The correct voltage for the system is listed on the serial number label next to the left power supply (see Figure 1). If the voltage listed matches your power source, continue with the installation. If the voltage does not match your power source, do not continue. Contact your DIGITAL sales representative.*

Figure 1: Shipping Carton Contents

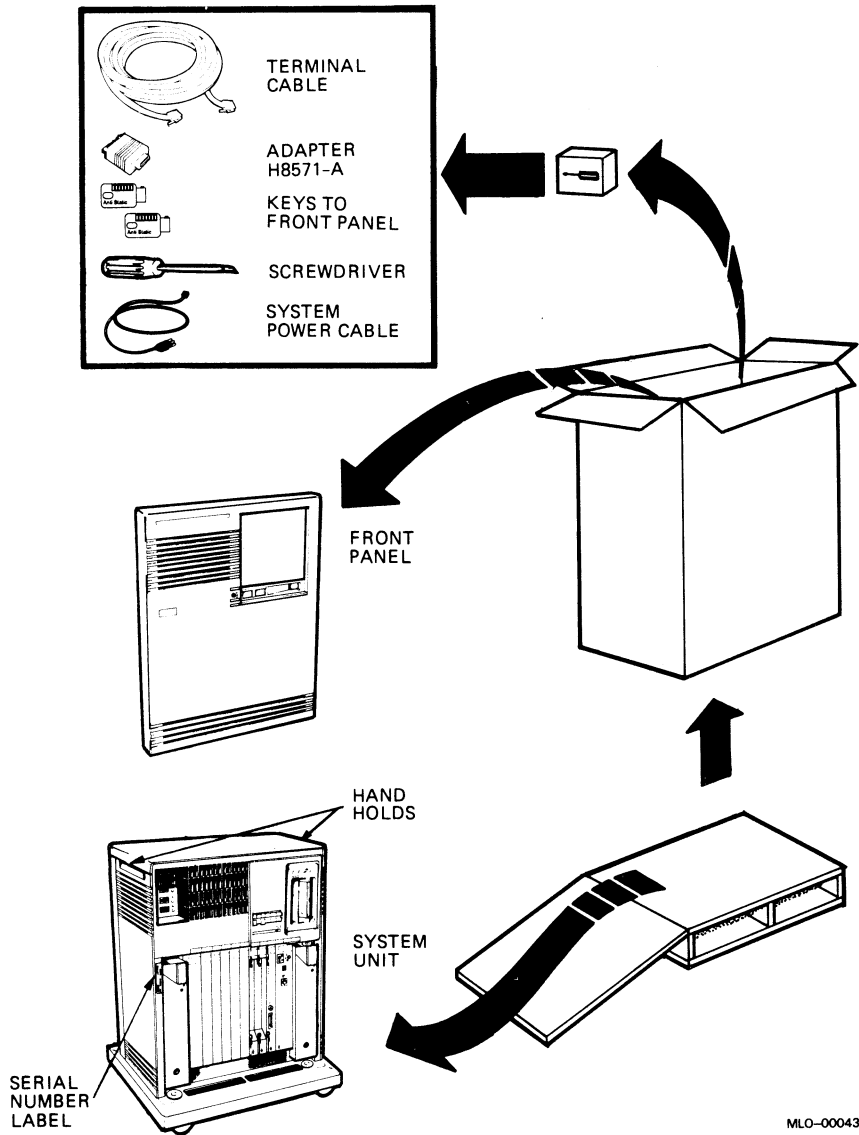

3 Place the System

The installation instructions that follow assume you have correctly followed the unpacking instructions on the carton.

CAUTION: *Moving and operating your system without releasing the shipping brackets may damage the mass storage devices.*

After unpacking your system, you can move it into position in two ways, as shown in Figure 2.

- You can roll it sideways.
- You can gently slide or walk it backward or forward by gripping the handholds on the side of the unit.

WARNING: *The system weighs between 50 kg (110 lb) and 64 kg (140 lb), depending on the options installed. Use two or more people to maneuver the system.*

During installation, leave a few inches behind the system for routing cables underneath the system box. Once installation is complete, you can place the system base directly against a wall. No rear ventilation is required.

Figure 2: Sliding the System into Place

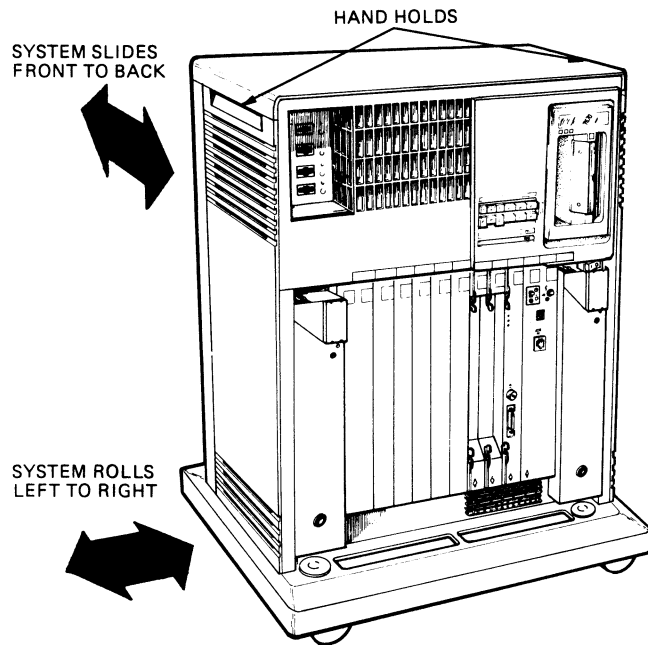

MLO-1806-87

4 Install the Console Terminal

The next step in installing your MicroVAX 3500 or VAXserver 3500 system is to set up the console terminal. You use the console terminal to communicate with your system. Your console terminal is packed with the following:

- Video monitor
- Keyboard and keyboard cable
- Console terminal power cord
- Documentation, including an installation guide and user's manual

Unpack the terminal and documentation. Use the instructions in the terminal installation guide to connect the various components of your terminal.

Read the instructions on installing and using your terminal that were provided with your console terminal. Before you connect the console terminal to your

system, turn on the terminal to make sure it works correctly and perform some set-up operations.

The terminal performs a self-test every time you turn it on. The documentation for your terminal describes a successful self-test and possible error messages that display if the terminal is not operating properly. Once the terminal passes the self-test, you should perform some set-up operations.

4.1 Perform Set-Up Operations

Set-up involves choosing how your video terminal operates. Certain parameters must be selected so that your terminal can communicate with your system: the terminal's baud rate should be set to 9600, and receive speed should be set to equal the transmit speed.

You choose set-up options from a series of menus that display when you press the **Set-Up** key on the terminal keyboard. Set-up instructions for terminals vary according to model, or, in some cases, according to which read-only memory (ROM) cartridge is installed in your terminal. Be sure to read the documentation provided with your terminal.

While most default settings are acceptable, you should perform the set-up procedure for your terminal to ensure appropriate set-up values. The two examples below provide set-up instructions for VT300- and VT200-series terminals.

For VT300-series terminals

1. Press **Set-Up** to display the Set-Up Directory screen.
2. Use the arrow keys to select the "Communications Set-Up" option and press **Enter**.
3. Make sure the "Transmit Speed" option in the "Current Setting" column is set to 9600. Use the left and right arrow keys to change the setting.
4. Make sure the "Receive Speed" option in the "Current Setting" column is set to "receive=transmit." Use the down arrow to move the cursor to this option, and the left and right arrows to change the setting.
5. Press **Select** to return to the Set-Up Directory screen.
6. Use the arrow keys to select the "Global Set-Up" option. Press **Enter** to display the Global Set-Up screen and use the arrow keys to select the "Comm1 Port" option.

7. If the port in the "Current Setting" column is selected for "RS-232," press **Enter** to select the "DEC-423" port.
8. Press **Select** to return to the Set-Up Directory screen.
9. Use the arrow keys to select the "Save Current Settings" option. Press **Enter** to save all current settings; then press **Set-Up** to exit the Set-Up Directory.

For VT200-series terminals

1. Press **Set-Up** to display the Set-Up Directory screen.
2. Use the arrow keys to select the "Default" option and press **Enter**. Default correctly sets all values except transmit speed.
3. Use the arrow keys to select the "Comm" option and press **Enter** to display the Communications Set-Up menu.
4. Use the arrow keys to select the "Transmit" option and, using **Enter**, set the speed to 9600.
5. Use the arrow keys to select the "To Directory" option and press **Enter**.
6. Use the arrow keys to select the "Save" option and press **Enter**; this option stores the set-up values. Then press **Set-Up** to exit the Set-Up Directory.

Once you have tested your terminal and performed set-up operations, you are ready to connect the console terminal to the system.

4.2 Connect the Console Terminal to the System

Connecting the console terminal to the system involves attaching one end of a cable to the cover panel of the central processing unit (CPU) module, and the other end of the cable to a communications port in the back of the terminal.

The CPU cover panel covers slots 1 and 2 and has two labels, KA650 and MS650, affixed to the top of the panel. The port on the back of the console terminal varies with the type of terminal. Separate illustrations and instructions are provided below for connecting VT300-series and VT200-series terminals.

For VT300-series terminals

Connect the console terminal to your system as follows:

1. Turn off the console terminal.
2. Find the terminal cable in the accessories box. The cable is labeled "DECconnect Office Cable" and has a DEC-423 modular plug on each end.
3. Connect the terminal cable to the DEC-423 modular jack labeled "1" on the rear of your terminal, according to the instructions in your terminal installation guide.
4. Feed the other end of the cable under the system base, either from behind or from the side. Draw up the cable and plug it into the DEC-423 modular jack labeled "A1" on the CPU cover panel, as shown in Figure 3.

For VT200-series terminals

Connect the console terminal to your system as follows:

1. Turn off the console terminal.
2. Find the terminal cable and modular-jack-to-25-pin adapter in the accessories box. The cable is labeled "DECconnect Office Cable" and has a DEC-423 modular plug on each end. The adapter is labeled "H8571-A".
3. Plug one end of the cable to the 25-pin adapter; then connect the adapter to the 25-pin communications port labeled "COMM" on the rear of your terminal, according to the instructions in your terminal installation guide.
4. Feed the other end of the cable under the system base, either from behind or from the side. Draw up the cable and plug it into the modified modular jack labeled "A1" on the CPU cover panel, as shown in Figure 4.

Figure 3: Connecting a VT300-series Console Terminal

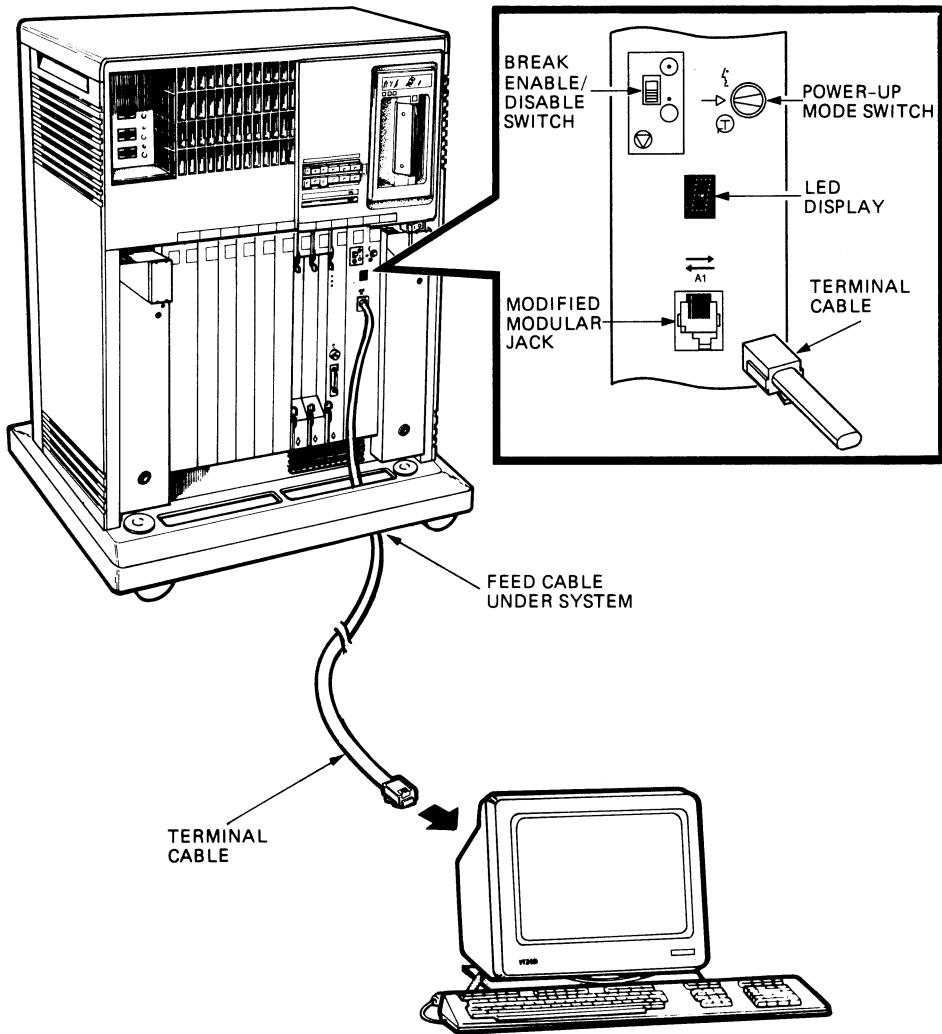

MLO-000432

Figure 4: Connecting a VT200-series Console Terminal

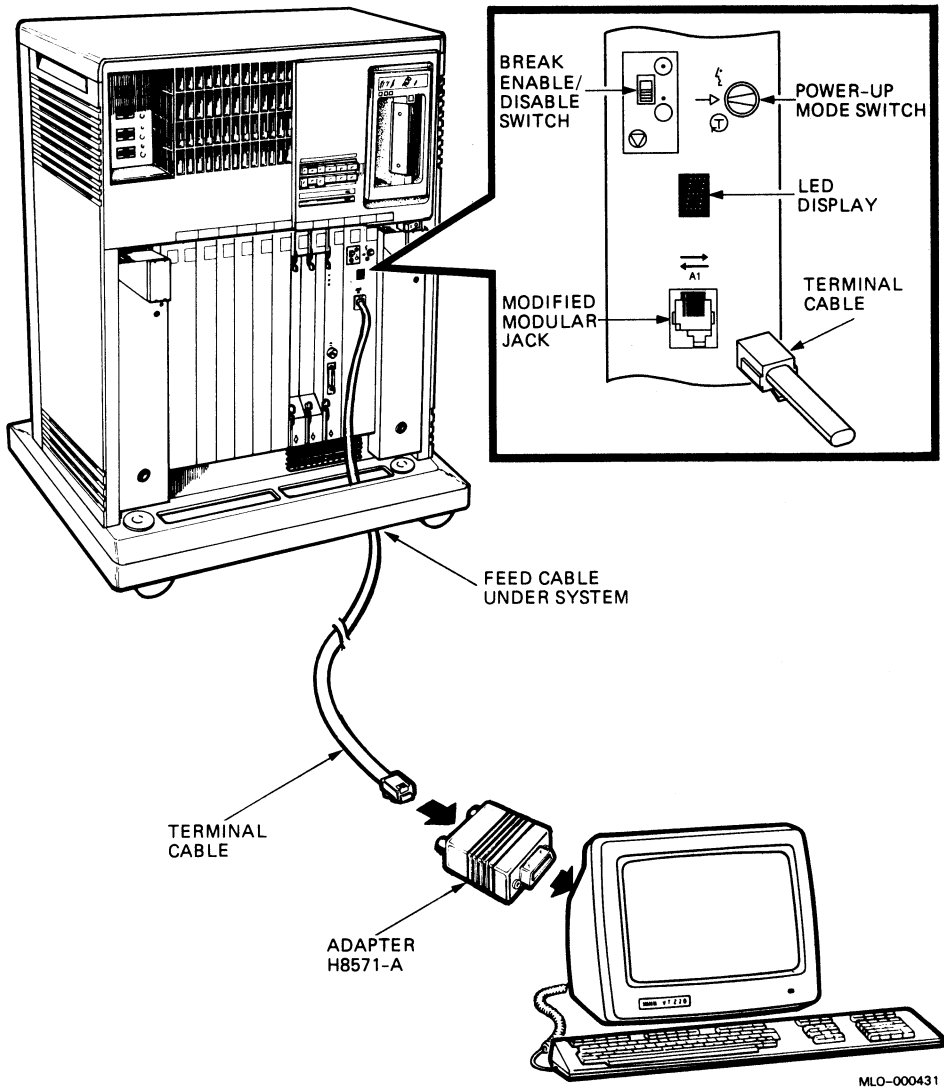

You are now ready to set the controls on your system.

5 Set Controls on Your System

All controls are on the front of the chassis, as shown in Figure 5.

Your system's fixed-disk drives and tape drives are shock mounted in a tray across the top of the system. MicroVAX 3500 systems have two variations of fixed-disk drives: RA70s and RD54s. The fixed-disk drives are behind the panel that contains controls and indicators for each of the drives. Make sure the disks are right enabled: in the case of RA70 drives, the write-protect switch should be in the out position; in the case of RD54 drives, the write-protect switch should be in the up position.

Figure 5: Front View of MicroVAX 3500

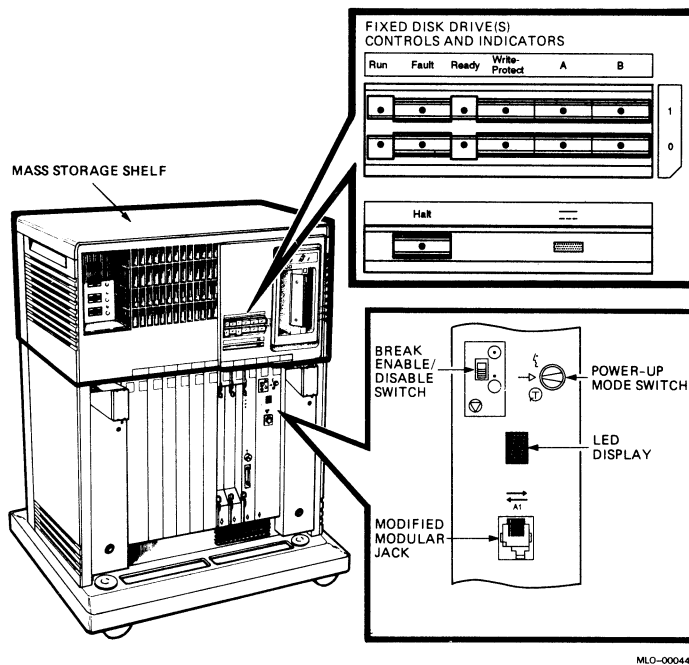

The following controls are located on the CPU cover panel covering slots 1 and 2.

- Break Enable/Disable Switch. The factory setting is break disable (down), indicated by the dot outside the circle. Leave the switch set to disable while you start the system for the first time and run diagnostic software

to test the system. With break disabled, your system automatically boots software when powered-up.

When installing system software you need the ability to halt the system. RA70-based systems have a Halt button, while RD54-based systems do not. For systems with RD54 fixed-disks, set the switch to break enable (up) before you install system software. This allows you to halt the system by pressing the Break key.

- **Power-Up Mode Switch.** This 3-position rotary switch determines how the system powers-up. The factory setting is Run Mode, indicated by an arrow. Set the switch to the Language Inquiry Mode (the uppermost position), indicated by a human profile, before you power-up your system the first time.
- **Baud Rate.** The baud rate switch is on the inside of the panel covering the CPU module. The factory setting is 9600. You should have already set your console terminal baud rate to 9600. The system and the terminal must be set to the same baud rate to communicate.

You are now ready to connect additional devices to your system.

6 Connect Additional Devices to the System

You can connect additional devices at this time, or you can complete installation and load system software before connecting other devices. Skip to the next step if you prefer to connect additional devices later. Use the instructions in this step when you are ready to connect the devices.

You make all connections directly to the module cover panels. Begin with the module at the far right. As you complete connections for each module, move left to the next module. The next five sections explain how to connect each type of device.

To help you make the proper connections, each module cover has an identifying label at the top. The label contains the option number and module number. Table 1 lists the identifying labels for all modules requiring connections. Use Table 1 to identify the modules as you connect additional devices to your system.

Table 1: Module Identification Labels

Module Number	Option Number	Description
M7620	KA650-AA	MicroVAX 3500 CPU
M7620	KA650-BA	VAXserver 3500 CPU
M7621-A	MS650-AA	MicroVAX 3500, VAXserver 3500 memory
M7942	MRV11-D	Programmable read-only memory
M7516	DELQA	Ethernet controller
M3118-YA	CXA16	16-Line asynchronous serial interface (RS-423-A, no modem support)
M3118-YB	CXB16	16-Line asynchronous serial interface (RS-422, noise immune)
M3119-YA	CXY08	8-Line asynchronous serial interface (full modem support)
M3121	DFA01	Integral dual modem
M8020	DPV11	Synchronous serial line interface
M8086-SA	LPV11	Dual parallel printer interface
M7546	TKQ70	TK70 tape drive controller
M7164, M7165	KDA50	RA disk drive controller
M7740	KLESI-SA	TU81-Plus tape drive controller
M7500	KMV1A	Programmable data communications interface
M7658-PA	DRQ3B-SA	Real-time parallel interface
M7651-PA	DRV1W-SA	Real-time parallel interface
M8634-PA	IEQ11-SA	IEEE instrument bus DMA controller
M3125-PA	IBQ01-SA	Bitbus-to-Q-bus DMA controller
A1009-PA	AAV11-SA	Digital-to-analog converter
A1008-PA	ADV11-SA	Analog-to-digital converter
M4002-PA	KWV11-SA	Programmable real-time clock
A026-PA	AXV11-SA	D/A and A/D converter

CAUTION: Do not operate the system without DIGITAL-supplied module cover panels. The module cover panels are required to protect the equipment and to

meet international regulatory standards. Do not substitute other cover panels as they may not meet the required specifications.

Operating the system without the module cover panels has the following consequences:

- *The system may overheat due to inadequate air circulation.*
- *The system will not comply with FCC and VDE requirements for shielding and may produce electrical interference that affects other equipment.*
- *The system is susceptible to electrical interference or damage from external sources.*

6.1 Connect Terminals and Serial Printers

You can connect up to 16 terminals and/or serial printers for each CXA16 or CXB16 module installed in your system. If the site has been prepared properly, the lines for the additional terminals and printer(s) are clearly labeled, and terminate near the system.

You do not connect the terminals and printers directly to the system, but to a cable concentrator (H3104), which has connections for up to eight terminals and printers. You then connect the cable concentrator to the system with a BC16D cable. The cable carton contains two H3104 cable concentrators and two BC16D cables for each CXA16 module in your system.

Connect the additional terminals and printers as follows:

1. Find the H3104 cable concentrator and BC16D cable in the cable carton.
2. Feed one end of the BC16D cable under the system box from the back or side and plug it into the connector. If you are going to connect both BC16D cables, connect the first to the connector labeled 8–15 on the CXA16 cover panel. If you are going to use only one BC16D cable, connect the cable to the connector labeled 0–7. Lock the connector into place by using the bail latches shown in Figure 6.

Figure 6: Connecting Devices to the CXA16 Module

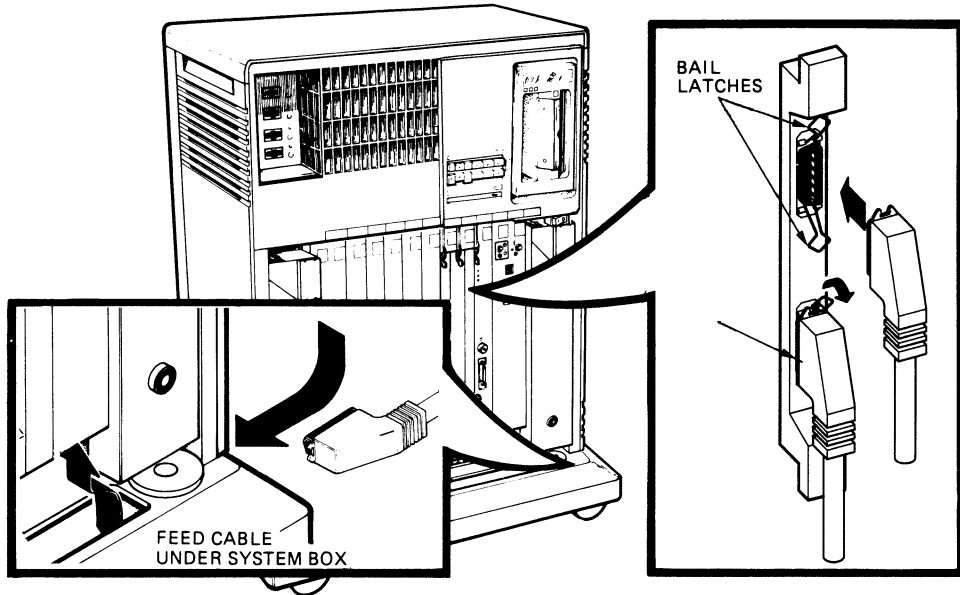

MLO-000433

3. Plug the other end of the BC16D cable into the cable concentrator. Lock the connector into place by using the bail latches.
4. Connect each printer and terminal cable directly to one of the modified modular jacks on the cable concentrator, as shown in Figure 7.

Figure 7: Connecting Devices to the Cable Concentrator

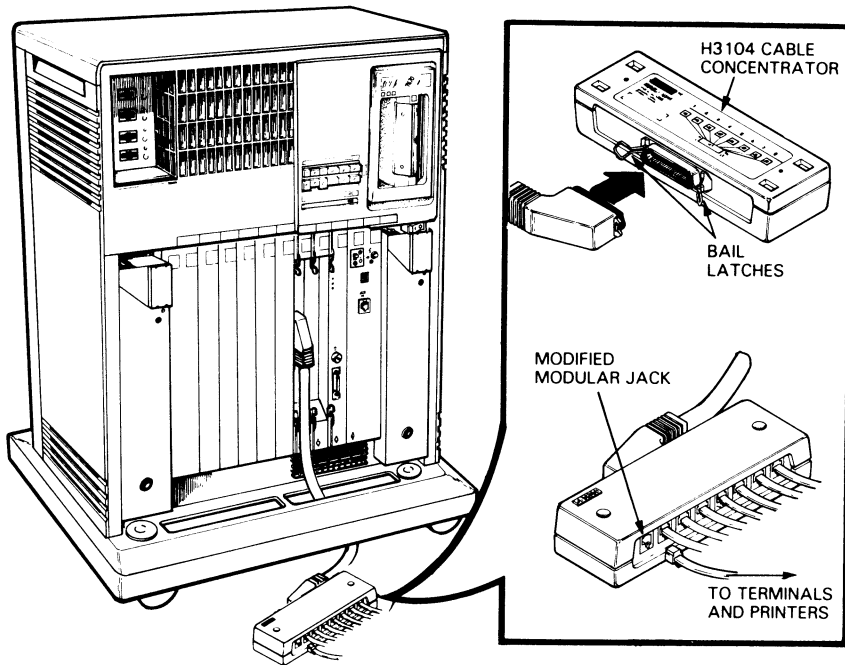

MLO-1809-87

5. If not already connected, connect the remote terminal or printer to the other end of the cable. Your terminal or printer documentation shows how to connect the cable. If the printer or terminal does not have a modified modular jack connection, use a passive adapter, available in 25- and 9-pin models.

Follow the same procedure for connecting a second BC16D cable to the CXA16, except plug the cable into the connector labeled 0-7.

You can mount the cable concentrator on a wall. Wall mounting enables you to keep cables off the floor. Use two screws, as shown in Figure 8.

NOTE: Be sure that you mount the cable concentrator less than 7.6 meters (25 feet) from the system, to ensure the BC16D cable reaches the system.

Figure 8: Mounting the Cable Concentrator

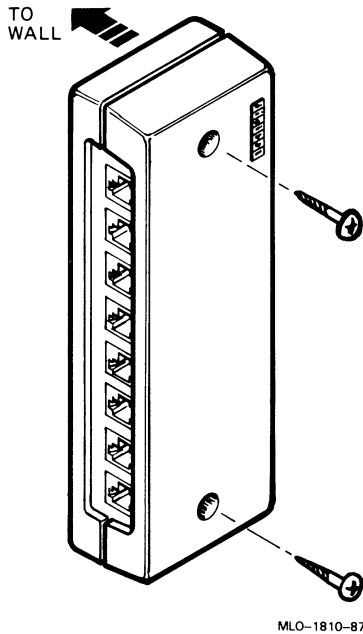

6.2 Connect Parallel Printers to the System

You can connect up to two parallel printers for each LPV11 module installed in your system.

Connect parallel printers to the LPV11 module as follows:

1. Find the BC27L-30 cable(s) in the cable carton.
2. Feed one end of the first BC27L cable under the system box from the back or side. Plug it into the connector labeled J1 on the LPV11 cover panel. Lock the connector into place by using the bail latches.
3. Plug the other end of the BC27L cable into the printer.

Follow the same procedure for connecting a second printer to the LPV11 module, except plug the cable into the connector labeled J2 on the LPV11 cover panel.

6.3 Connect Synchronous Modems to the System

You can connect one synchronous modem to your system for each DPV11 or KMV1A module installed in the system.

Connect a synchronous modem to a DPV11 or KMV1A module as follows:

1. Find the BC22E or BC22F cable in the cable carton.
2. Feed one end of the cable under the system box from the back or side. Plug it into the connector on the DPV11 or KMV1A cover panel. Lock the connector into place by using the bail latches.
3. Plug the other end of the cable into the modem. Refer to your modem documentation for the location of the connector, and for instructions on using your modem.

6.4 Connect Asynchronous Modems to the System

You connect asynchronous modem lines to the CXY08 module, which supports up to eight lines.

To connect a modem to a CXY08 module, see Figure 9, and refer to the following instructions:

1. Find the BC19N-12 cable assembly in the cable carton.
2. Feed the end of the large cable under the system and plug it into the connector. If you are going to use both BC19N-12 cables, connect the first to the connector labeled 4-7 on the CXY08 cover panel. In you are going to use only one cable, connect the cable to the connector labeled 0-3. Lock the connector into place with the bail latches.
3. Attach a modem to one of the four connectors at the opposite end of the cable assembly. If you want to place the modem farther away from the system, attach a BC22F modem cable between the cable assembly and the modem. Refer to your modem documentation for the location of the connector, and for instructions on using your modem.

Figure 9: Connecting a Modem to a CXY08 Module

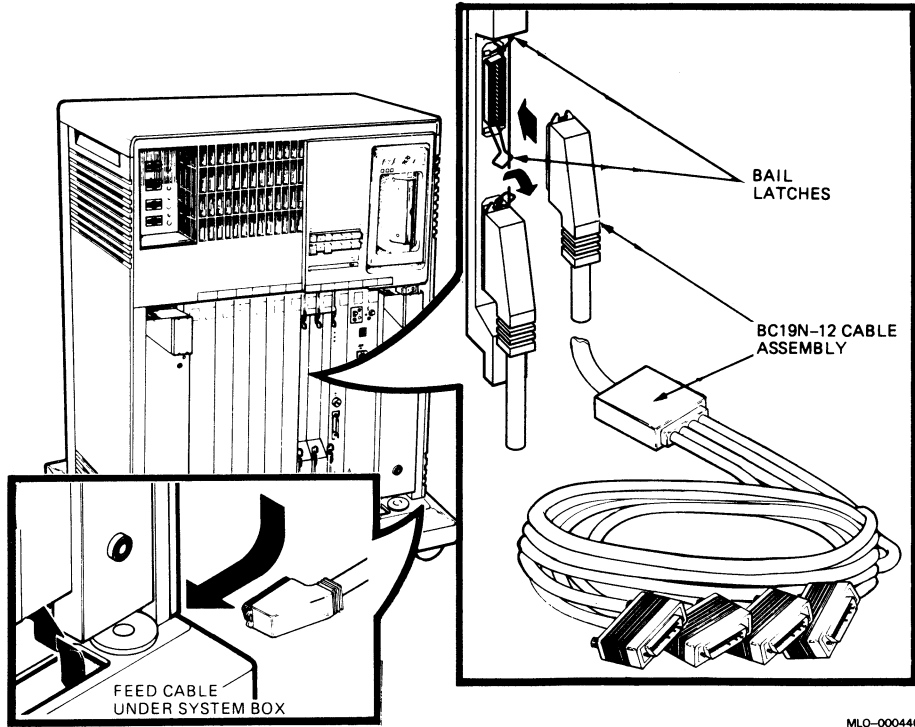

Repeat the same procedure for connecting a second BC19N cable assembly, except plug the cable into the connector labeled 0-3.

6.5 Connect an Internal Modem to Telephone Lines

NOTE: *The DFA01 modem is available for U.S. and Canadian customers. Depending on the country you live in, the Telecommunication Administration (PTT) may not allow you to connect private integral modems to the public switched telephone network. Call your DIGITAL representative for information on modem availability in your country.*

DFA01 Modem

You connect the DFA01 module to telephones lines. The DFA01 module supports two modems, modem A and modem B. Each modem requires its own telephone.

The DFA01 modem connects to the following basic types of dial-up telephone service:

- RJ11C (United States) and CA11A (Canada) standard single-line telephone service. The switchpacks are factory set for this service. (If you have this service, you have one wall-mounted modular telephone jack per telephone.)
- RJ12C/RJ13C (United States) and CA12A/CA13A (Canada) telephone service. The switchpacks are factory set for this service. (If you have this service, you have one wall-mounted modular telephone jack per telephone.)
- RJ41S/RJ45S (United States) and CA41A/CA45A (Canada) data jack telephone service. (If you have this service, you have two wall-mounted modular telephone jacks per telephone.)

NOTE: *If you do not know which telephone service you are using, call your telephone company. Information about the type of telephone service you are using is readily available to you as a telephone customer.*

RJ11C/CA11A, RJ12C/CA12A, and RJ13C/CA13A Service

Use the following procedure to connect the DFA01 modem to RJ11C/CA11A, RJ12C/CA12A, or RJ13C/CA13A service.

NOTE: *If you plan to use both modem A and modem B, you will need two telephones, one for each modem.*

1. Disconnect the telephone line from the wall-mounted modular telephone jack. Leave the telephone line connected to the telephone, as shown in Figure 10.

Figure 10: Disconnecting the Telephone Line (Single- and Multi-Line Service)

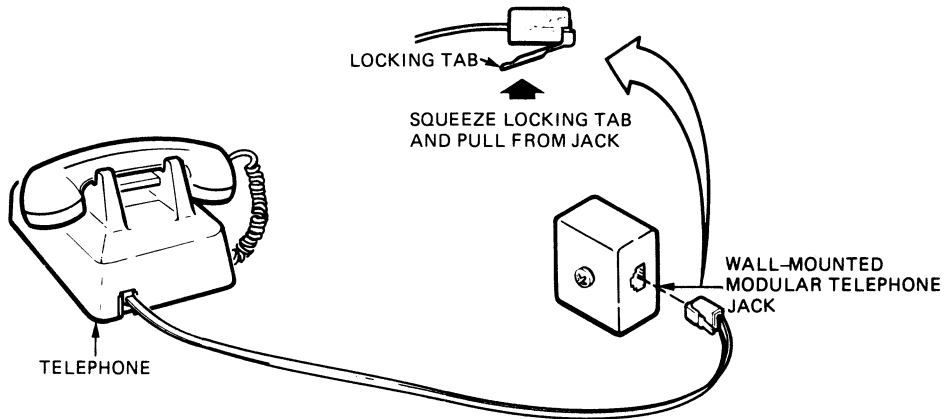

MLO-1780-87

2. Take one end of one of the cords included with the DFA01 modem (17-00089-01) and plug it into the top jack on the DFA01 cover panel (modem A). The top jack on the DFA01 cover panel is marked with the line icon, as shown in Figure 11.

Figure 11: Installing Telephone Cord (Single- and Multi-Line Service)

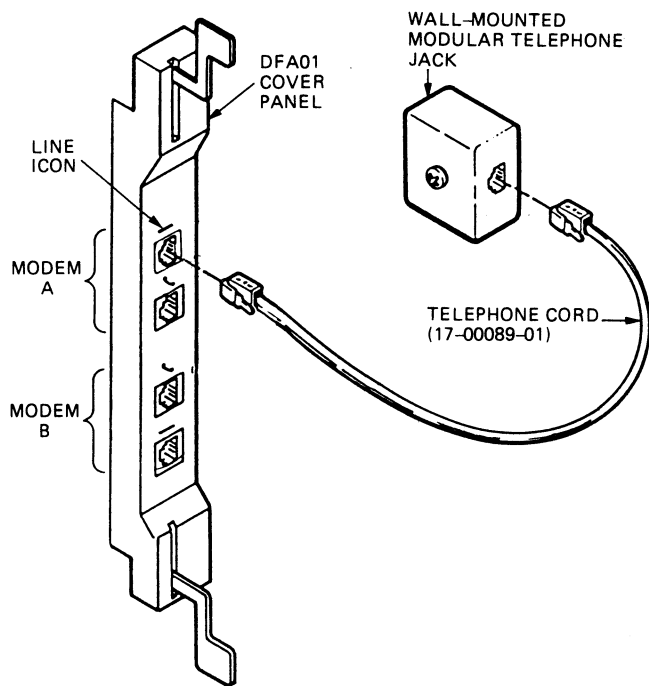

MLO-1781-87

3. Connect the other end of the cord to the wall-mounted telephone jack.
4. To install voice communication on modem A, take the end of the telephone line that you disconnected from the wall jack in step 1 and connect it to the second jack from the top of the DFA01 cover panel, as shown in Figure 12. This jack is marked with the telephone icon.

Figure 12: Connecting Modem to Telephone (Single- and Multi-Line Service)

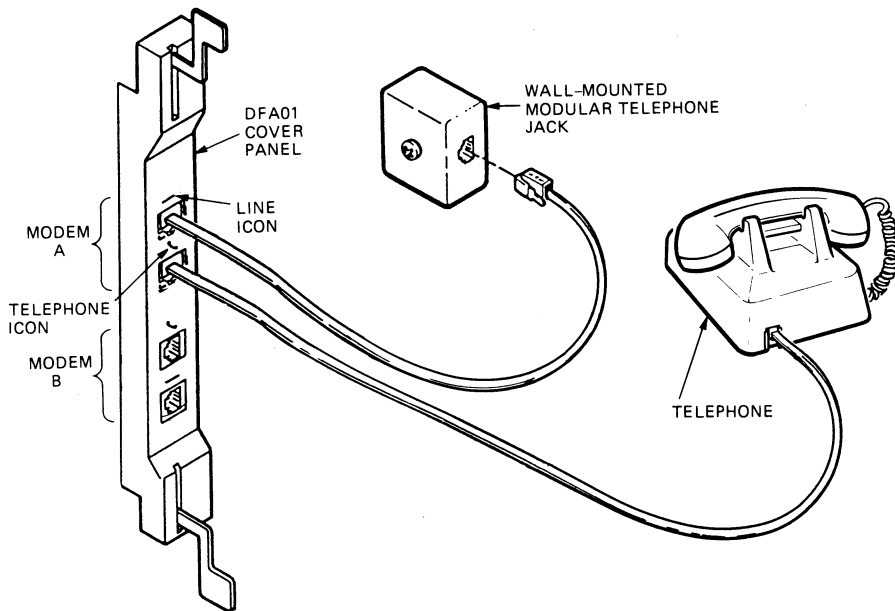

MLO-1782-87

If you do not plan to use modem B, do not perform the following step. If you require use of a second modem, set up modem B for use by continuing with step 5.

5. Using a second telephone, set up modem B by following the same procedure used to engage modem A. Notice, however, that the jack positions on the DFA01 cover panel are reversed for modem B. The bottom jack on the DFA01 cover panel is marked with a line icon; the second jack from the bottom is marked with a telephone icon. Connect the wall-mounted modular jack to the bottom jack on the DFA01 cover panel. Connect the telephone line to the second jack from the bottom of the cover panel.

RJ41S/CA41A and RJ45S/CA45A Service

Use the following procedure to connect the modem to RJ41S/CA41A and RJ45S/CA45A data jack service. You will need a standard 8-wire telephone cord (not supplied with the DFA01 modem). If you have this service, you have two wall-mounted modular telephone jacks per telephone.

NOTE: *If you plan to use both modem A and modem B, you will need two telephones, one for each modem.*

Do not unplug the telephone line from the wall-mounted modular telephone jack.

1. Connect one end of an 8-wire telephone cord (not supplied with the DFA01 modem) into the top jack on the DFA01 cover panel (modem A). The top jack on the cover panel is marked with the line icon.
2. Connect the other end of the telephone cord into a second wall-mounted modular telephone jack, as shown in Figure 13.

If you require voice communication on modem A, refer to step 4 for more information.

3. If you do not plan to use modem B, skip this step and proceed to step 4. If you plan to use modem B, connect a second 8-wire telephone line to the bottom jack on the DFA01 cover panel, marked with a line icon. (Notice that the jack positions are reversed for modem B.) Connect the other end of the cord to a wall-mounted modular telephone jack.

If you require voice communication on modem B, refer to step 4 for more information.

4. If you require voice communication with the DFA01 modem, you may want to consider this step.

You can install voice communication on the DFA01 modem in one of two ways. Depending on the location of your system, telephone, and wall-mounted modular telephone jacks, one of the following two methods of installing voice communication may be more appropriate for your system.

The first way of installing voice communication is established for both modem A and modem B in the preceding steps. The telephone is connected to the wall-mounted modular telephone jack, which is, in turn, connected to the DFA01 cover panel (see Figure 13).

Figure 13: Connecting Modem to Wall-Mounted Jack (Data Jack Service)—Telephone-to-Wall-Jack Connection

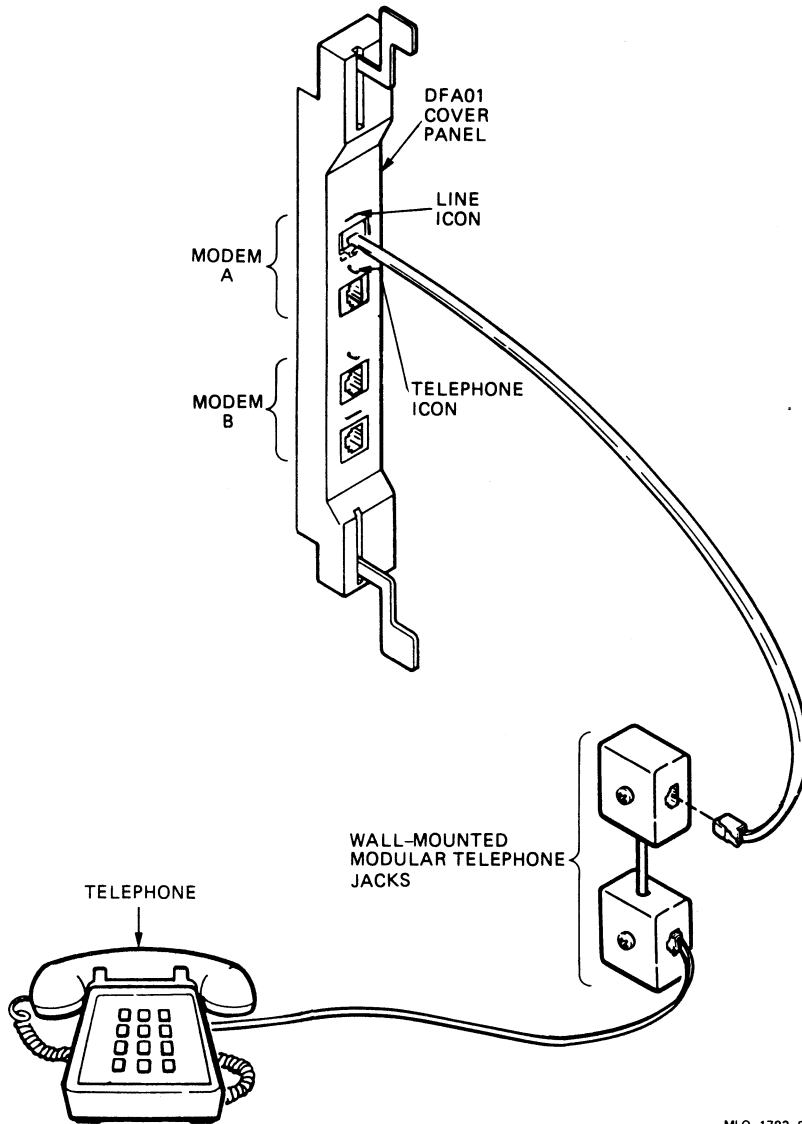

MLO-1783-87

The following describes an alternative method of installing voice communication on the DFA01 modem. The telephone is connected to the DFA01 cover panel, which is, in turn, connected to the wall-mounted modular telephone jack (see Figure 14).

- a. Leave connected the 8-wire telephone cord that attaches the DFA01 cover panel to a wall-mounted modular telephone jack.
- b. Disconnect the telephone line from the wall-mounted modular telephone jack. Leave the telephone line connected to the telephone.
- c. Connect the telephone line from the telephone to the DFA01 cover panel. To install voice communication on modem A, plug the telephone line into the second jack from the top of the cover panel, marked with the telephone icon. To install voice communication on modem B, plug the telephone line into the second jack from the bottom of the cover panel, marked with the telephone icon.

Setting Up Terminal Lines

Before you can use the DFA01 modem, you must set up your operating system software to recognize the DFA01 modem.

Set up your operating system software to support the following four terminal lines for the DFA01 modem:

- Modem A—primary channel
- Modem A—on-line control channel (OLC)
- Modem B—primary channel
- Modem B—on-line control channel (OLC)

Refer to your operating system documentation to determine how to make permanent terminal line definitions so that every time the system is powered up, the terminal lines are configured for proper operation.

Figure 14: Connecting Modem to Wall-Mounted Jack (Data Jack Service)—Telephone-to-DFA01 Connection

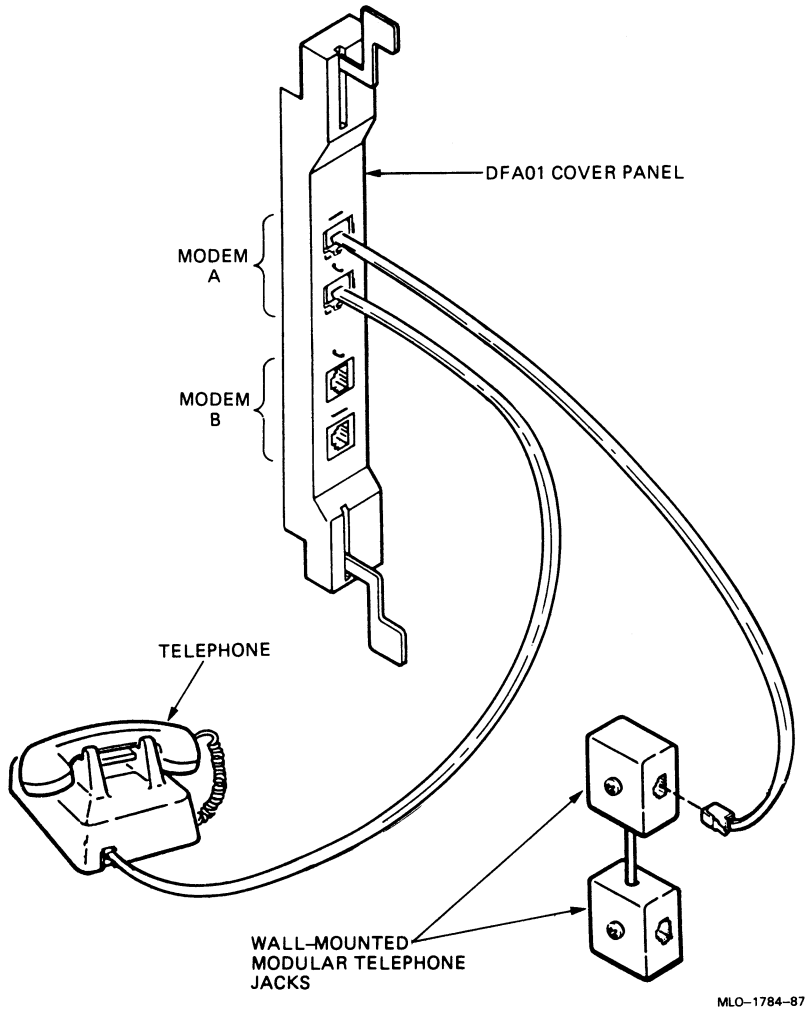

You may need to define the following terminal line characteristics.

- Modem control—to support full EIA modem control.
- Speed, parity, data bits—terminal lines should be set to 2400 baud, parity disabled, and 8 data bits to coincide with the modem power-up defaults.
- Dial up—to support dial-up operation, if supported.
- Hang up—to disable automatic hang up of the lines when logging out, or when completing a dialog with the modem using terminal emulation software. With automatic hang up disabled, you can modify the DFA01 modem operating parameters (from applications software or when using a terminal emulator). You can then exit the program without the DFA01 modem resetting these parameters to power-up default values.

6.6 Connect to an Ethernet Network

You can connect your system to a network if your system has a DELQA module and if the Ethernet cabling is in place. Figure 15 shows a network connection. Make a network connection as follows:

1. Find the Ethernet transceiver cable in the cable carton. The cable has a male connector at one end and a female connector at the other end.
2. Feed the male connector under the system and plug it into the female connector on the DELQA panel. Slide up the locking device on the female connector to secure the connection.
3. Connect the other end of the cable to one of the following devices:
 - An H4000 transceiver located on a traditional baseband Ethernet cable
 - A DELNI, which can, in turn, be connected to a baseband Ethernet cable, or which can connect up to eight systems in a local area network
 - A DESTA converter, if you need to connect to a ThinWire network

Figure 15: Making a Network Connection

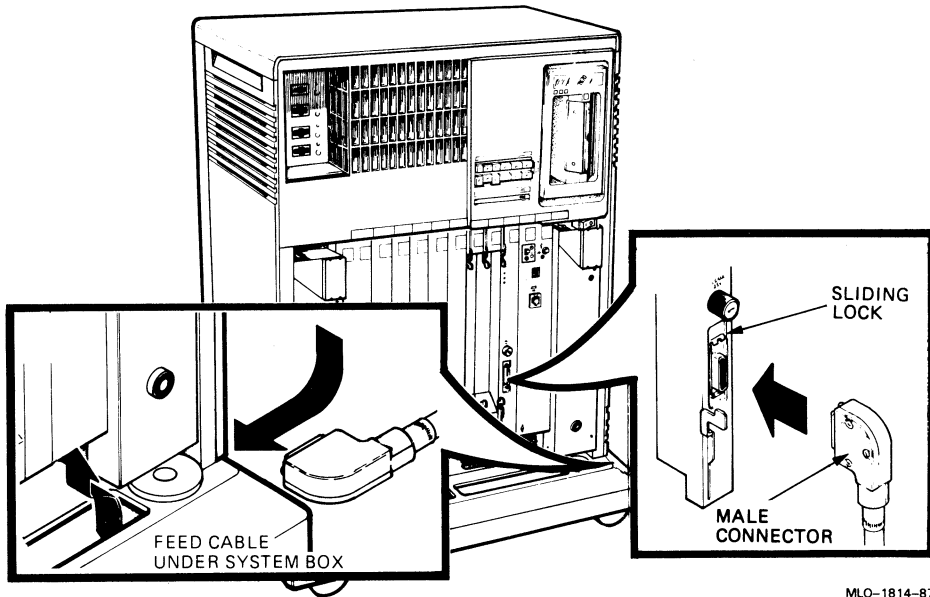

MLO-1814-87

DIGITAL's Network and Communications (NaC) publications explain the types of network connections possible.

7 Connect the System Power Cable

Do not proceed unless you have verified that your system's power requirements match your power source. The correct voltage for the system is listed on the serial number label next to the left power supply.

If the voltage listed matches your power source, continue with the installation. If the voltage does not match your power source, *do not* continue. Contact your DIGITAL sales representative.

CAUTION: *Operating a system with incorrect voltage can damage the system.*

Connect the power cable to the system as follows:

1. Make sure the system on/off (1/0) switch is set to off (0), and that all devices connected to the system are turned off.

2. Find the power cable packed inside the system shipping carton.
3. Make sure the pronged end of the power cable plug matches the wall outlet. Several types are shown in Figure 16.

Figure 16: Power Cords

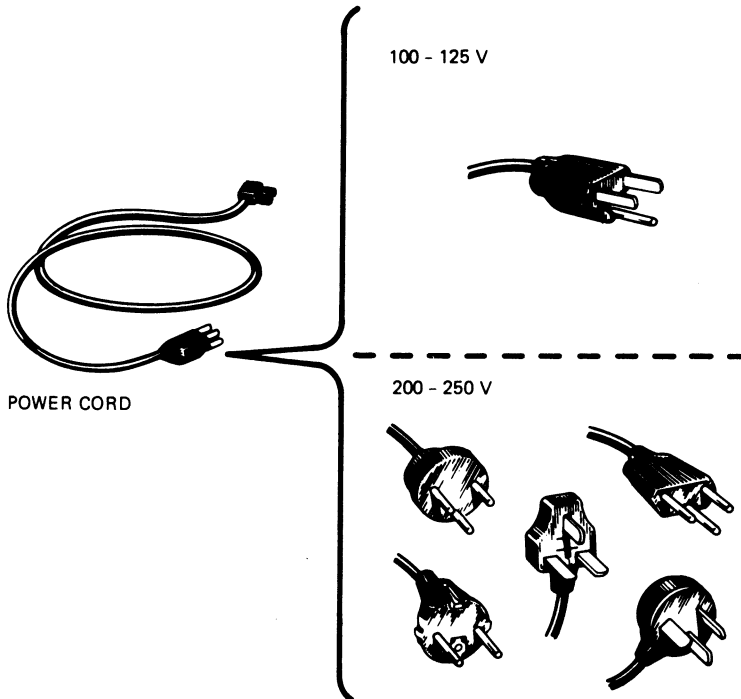

MLO-1816-87

4. Feed the opposite end of the cable under the system from the rear or the left and attach it, as shown in Figure 17.

Figure 17: Attaching Power Cord to the System

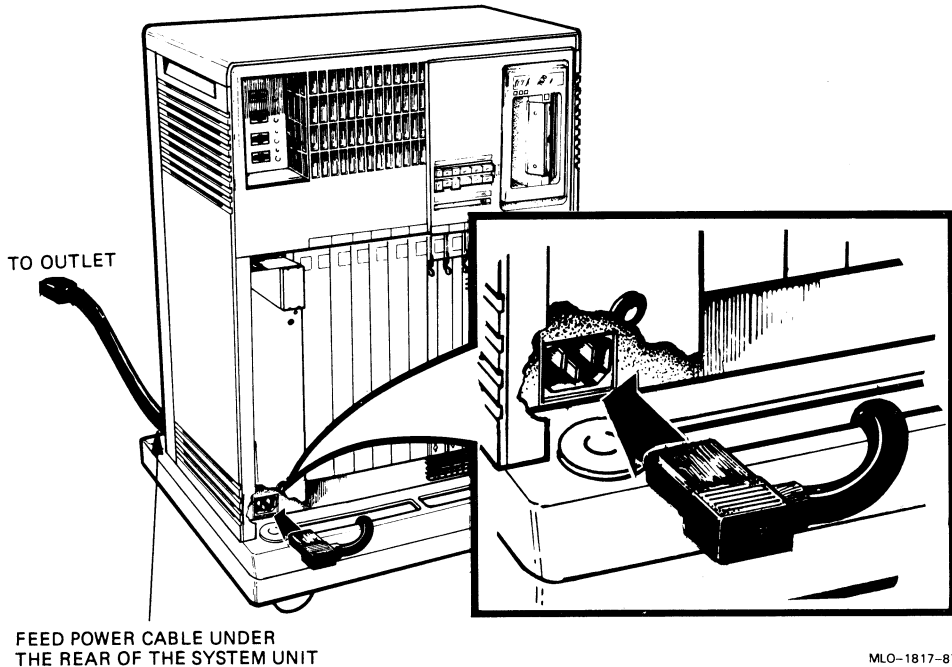

5. Plug the pronged end of the power cable into the wall outlet.

8 Turn on the System and Select a Language

You are now ready to turn on your system and select a language. The language you select controls only the language of the console program, which is a part of MicroVAX firmware contained in the CPU. MicroVAX firmware enables you to give commands to the system and also generates error messages. CPU firmware is described in *MicroVAX 3500 VAXserver 3500 Technical Information*, which is included in this documentation kit.

Turn on your system and select a language as follows:

1. Turn on your console terminal and wait until it has performed its self-tests successfully.

2. Turn on your system by setting the power switch to on (1). The switch should glow orange.
3. Within a few moments, the Language Selection Menu should display on your console terminal, as shown in Figure 18.

Figure 18: Language Selection Menu

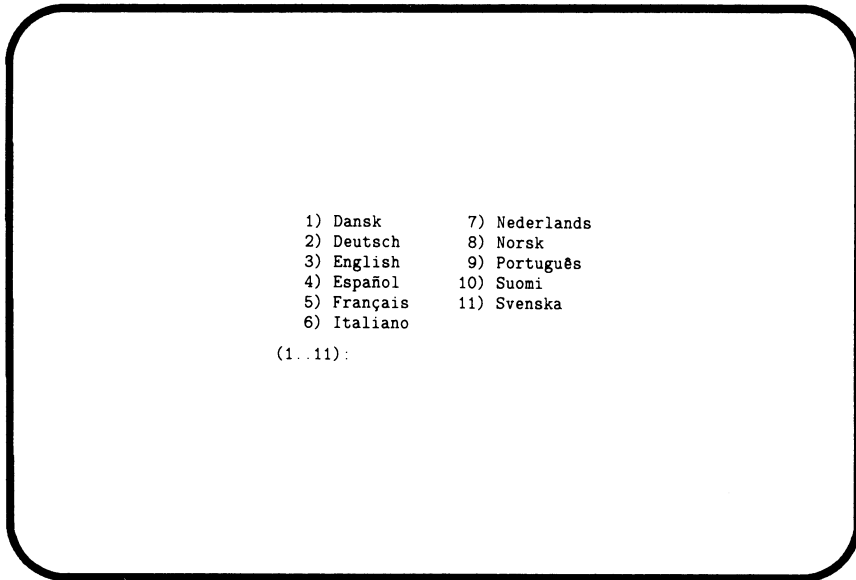

MLO-1818-87

4. Select a language by typing the number corresponding to your choice and pressing **Return**.

NOTE: *Some older terminals do not support multiple languages, the language selection menu does not appear and the system defaults to English.*

After you select a language, the system runs power-on self-tests. Within a few moments, your console terminal should display a series of numbers as the system tests itself. The example in Figure 19 shows the screen after a successful power-on test.

Figure 19: Example of a Successful Power-On

```
KA650-A V04/0117
Performing normal system tests.
30..29..28..27..26..25..24..23..22..21..20..19..18..17..16..15..
14..13..12..11..10..09..08..07..06..05..04..03..
Loading system software.
  2..
-DUA0
```

MLO-1819-87

If the self-tests do not start or complete successfully, as shown in the example in Figure 19, your system may have a problem. Refer to *MicroVAX Troubleshooting and Diagnostics* (included in this documentation kit) for instructions.

If the self-tests run successfully, turn the Power-Up Mode switch to the Run Mode, indicated by an arrow. This saves the language you selected.

9 Attach the Front Panel to the System

The final step of installation is attaching the front panel. When you are ready to attach the front panel, follow the instructions in this section.

NOTE: For RD54-based systems, since you need access to the Break Enable/Disable switch during software installation, you may want to wait until after you install system software before attaching the front panel.

The front panel is packed separately in the system shipping carton. Attach the front panel as shown in Figure 20.

Figure 20: Attaching the Front Panel

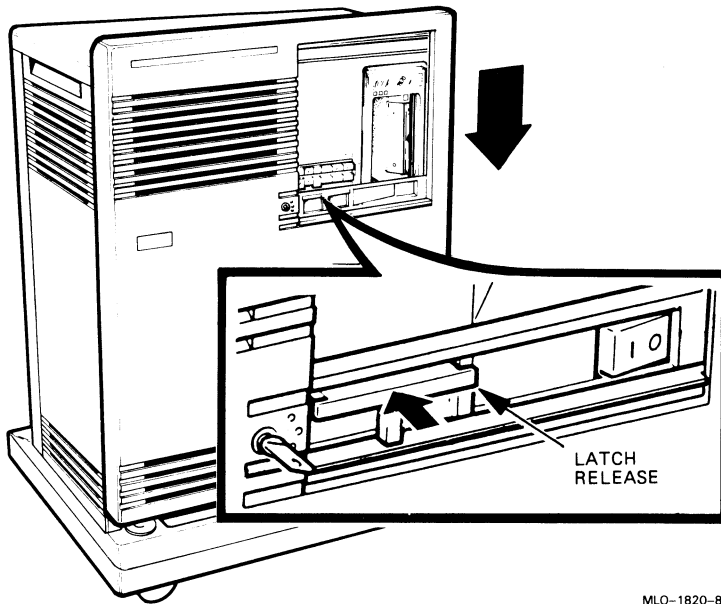

MLO-1820-87

1. Slide the latch release on the front panel to the out position.
2. Holding the panel with two hands, place it flush against the front of the box, about an inch above the bottom.
3. Slide the panel down until it locks into place. Secure the panel by pushing in the latch release.

NOTE: *The window on the front panel must be open to attach the front panel. Instructions for removing the front panel and operating the window controls are provided in MicroVAX 3500 VAXserver 3500 Operation.*

10 After Installation

You should now read *MicroVAX 3500 VAXserver 3500 Operation* to learn how to use your system. You must know how to operate the system controls and the TK70 tape drive before you install system software or run diagnostic software. Both system software and diagnostic software are shipped on tape cartridges.

While optional, DIGITAL strongly recommends that you run the diagnostic software supplied with your system before you install system software. The diagnostics verify your system's configuration and check to see if each device is working properly. The diagnostic software is on a tape cartridge labeled MV DIAG CUST TK50. Chapter 3 of *MicroVAX Troubleshooting and Diagnostics* describes how to run the diagnostic software.

Refer now to instructions on operating your TK70 in *MicroVAX 3500 VAXserver 3500 Operation*.

HOW TO ORDER
ADDITIONAL DOCUMENTATION

From	Call	Write
Alaska, Hawaii, or New Hampshire	603-884-6660	Digital Equipment Corporation P.O. Box CS2008 Nashua, NH 03061
Rest of U.S.A. and Puerto Rico*	800-258-1710	
* Prepaid orders from Puerto Rico must be placed with DIGITAL's local subsidiary (809-754-7575)		
Canada	800-267-6219 (for software documentation) 613-592-5111 (for hardware documentation)	Digital Equipment of Canada Ltd. 100 Herzberg Road Kanata, Ontario, Canada K2K 2A6 Attn: Direct Order desk
Internal orders (for software documentation)	—	Software Distribution Center (SDC) Digital Equipment Corporation Westminster, MA 01473
Internal orders (for hardware documentation)	617-234-4323	Publishing & Circulation Serv. (P&CS) NR03-1/W3 Digital Equipment Corporation Northboro, MA 01532

Reader's Comments

MicroVAX 3500
VAXserver 3500
Installation
EK-O27AB-IN-002

Your comments and suggestions will help us improve the quality of our future documentation. Please note that this form is for comments on documentation only.

I rate this manual's:	Excellent	Good	Fair	Poor
Accuracy (product works as described)	<input type="checkbox"/>	<input type="checkbox"/>	<input type="checkbox"/>	<input type="checkbox"/>
Completeness (enough information)	<input type="checkbox"/>	<input type="checkbox"/>	<input type="checkbox"/>	<input type="checkbox"/>
Clarity (easy to understand)	<input type="checkbox"/>	<input type="checkbox"/>	<input type="checkbox"/>	<input type="checkbox"/>
Organization (structure of subject matter)	<input type="checkbox"/>	<input type="checkbox"/>	<input type="checkbox"/>	<input type="checkbox"/>
Figures (useful)	<input type="checkbox"/>	<input type="checkbox"/>	<input type="checkbox"/>	<input type="checkbox"/>
Examples (useful)	<input type="checkbox"/>	<input type="checkbox"/>	<input type="checkbox"/>	<input type="checkbox"/>
Index (ability to find topic)	<input type="checkbox"/>	<input type="checkbox"/>	<input type="checkbox"/>	<input type="checkbox"/>
Page layout (easy to find information)	<input type="checkbox"/>	<input type="checkbox"/>	<input type="checkbox"/>	<input type="checkbox"/>

What I like best about this manual: _____

What I like least about this manual: _____

My additional comments or suggestions for improving this manual:

I found the following errors in this manual:

Page	Description
_____	_____
_____	_____
_____	_____

Please indicate the type of user/reader that you most nearly represent:

- | | |
|---|---|
| <input type="checkbox"/> Administrative Support | <input type="checkbox"/> Scientist/Engineer |
| <input type="checkbox"/> Computer Operator | <input type="checkbox"/> Software Support |
| <input type="checkbox"/> Educator/Trainer | <input type="checkbox"/> System Manager |
| <input type="checkbox"/> Programmer/Analyst | <input type="checkbox"/> Other (please specify) _____ |
| <input type="checkbox"/> Sales | |

Name/Title _____ Dept. _____

Company _____ Date _____

Mailing Address _____

Phone _____

Do Not Tear — Fold Here and Tape

digitalTM



NO POSTAGE
NECESSARY
IF MAILED
IN THE
UNITED STATES

BUSINESS REPLY MAIL

FIRST CLASS PERMIT NO.33 MAYNARD MASS.

POSTAGE WILL BE PAID BY ADDRESSEE

**DIGITAL EQUIPMENT CORPORATION
CORPORATE USER PUBLICATIONS
MLO5-5/E45
146 MAIN STREET
MAYNARD, MA 01754-2571**

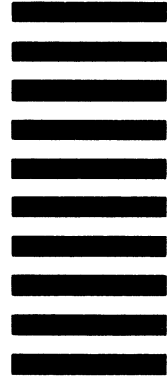

Do Not Tear — Fold Here

Cut Along Dotted Line

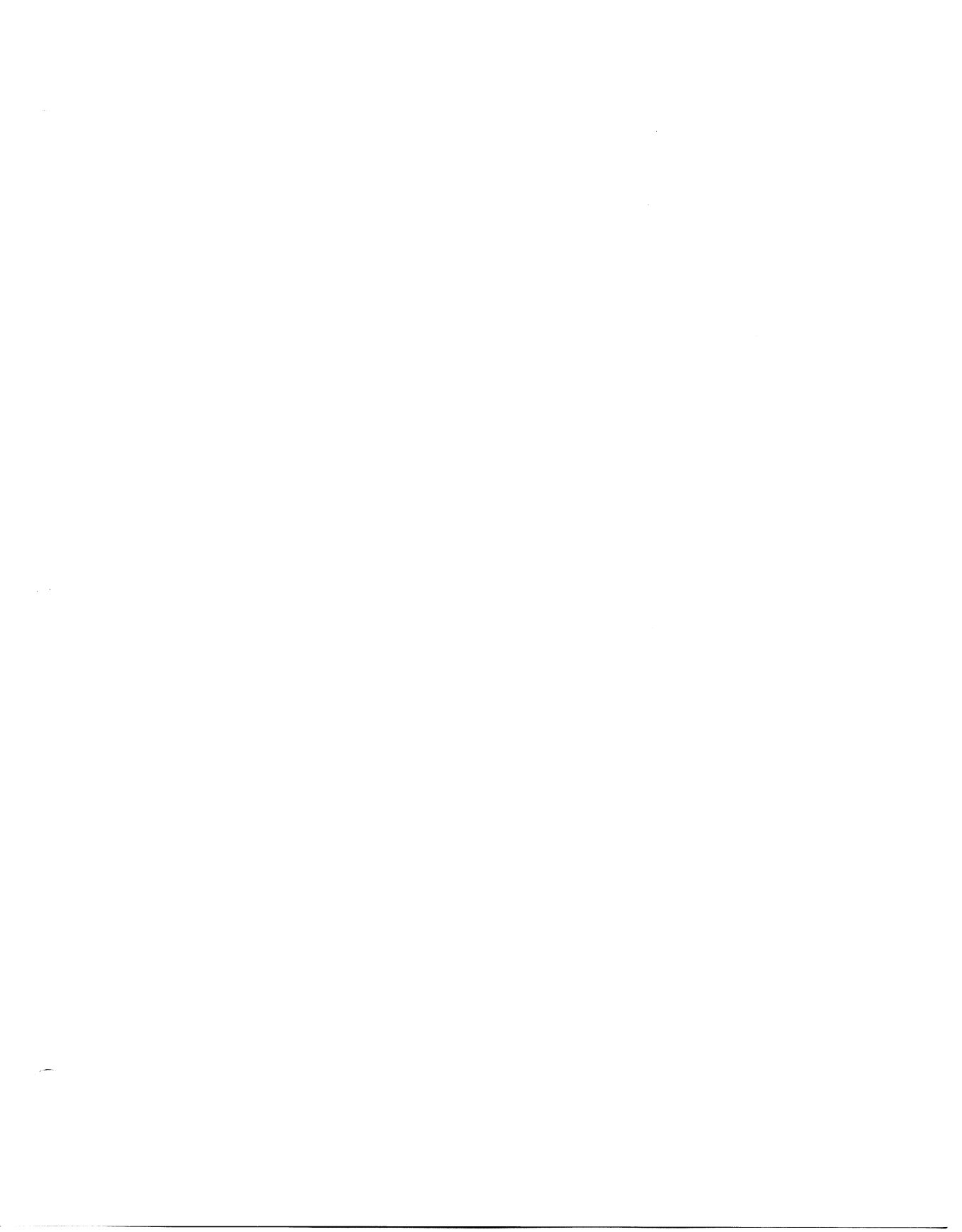

digital