

# AlphaServer Intelligent Peripheral Platform

---

## Hardware Owner's Guide

Part Number: EK-ASIP2-OG. D01

**May 1999**

**Compaq Computer Corporation  
Houston, Texas**

---

**May 1999**

The information in this publication is subject to change without notice.

COMPAQ COMPUTER CORPORATION SHALL NOT BE LIABLE FOR TECHNICAL OR EDITORIAL ERRORS OR OMISSIONS CONTAINED HEREIN, NOR FOR INCIDENTAL OR CONSEQUENTIAL DAMAGES RESULTING FROM THE FURNISHING, PERFORMANCE, OR USE OF THIS MATERIAL. THIS INFORMATION IS PROVIDED "AS IS" AND COMPAQ COMPUTER CORPORATION DISCLAIMS ANY WARRANTIES, EXPRESS, IMPLIED OR STATUTORY AND EXPRESSLY DISCLAIMS THE IMPLIED WARRANTIES OF MERCHANTABILITY, FITNESS FOR PARTICULAR PURPOSE, GOOD TITLE AND AGAINST INFRINGEMENT.

This publication contains information protected by copyright. No part of this publication may be photocopied or reproduced in any form without prior written consent from Compaq Computer Corporation.

© 1999 Digital Equipment Corporation. All rights reserved. Printed in the U.S.A.

The software described in this guide is furnished under a license agreement or nondisclosure agreement. The software may be used or copied only in accordance with the terms of the agreement.

Compaq, the Compaq logo, and the Digital logo registered in United States Patent and Trademark Office.

AlphaServer, DIGITAL, Tru64 UNIX, DEEvent, DEChub, HUBwatch, LA75 Plus Companion, RX, RZ, StorageWorks, and ThinWire, are trademarks of Compaq Computer Corporation.

The following are third-party trademarks:

Access I/O is a registered trademark of Access I/O Corporation.

Amphenol is a registered trademark of Canadian Imperial Bank of Commerce (N.Y. Agent).

Dialogic is a registered trademark and D/121B, DTI/211, DTI/212, LSI/120, and PEB are trademarks of Dialogic Corporation.

Microsoft and Windows are registered trademarks and Windows NT is a trademark of Microsoft Corporation.

UNIX is a registered trademark in the United States and other countries licensed exclusively through X/Open Company Ltd.

All other trademarks and registered trademarks are the property of their respective owners.

**FCC Notice:** This equipment generates, uses, and may emit radio frequency energy. The equipment has been type tested and found to comply with the limits for a Class A digital device pursuant to Part 15 of FCC rules, which are designed to provide reasonable protection against such radio frequency interference.

Operation of this equipment in a residential area may cause interference in which case the user at his own expense will be required to take whatever measures may be required to correct the interference.

Any modifications to this device - unless expressly approved by the manufacturer - can void the user's authority to operate this equipment under part 15 of the FCC rules.

**Note:** Additional information on the need to interconnect the device with shielded (data) cables or the need for special devices, such as ferrite beads on cables, is required if such means of interference suppression was used in the qualification test for the device. This information will vary from device to device and needs to be obtained from the EMC group or product manager.

警告使用者:

這是甲類的資訊產品，在居住的環境中使用時，可能會造成射頻干擾，在這種情況下，使用者會被要求採取某些適當的對策。

に基づくクラスA情報技術装置です。この装置を家庭環境で使用すると電波妨害を引き起こすことがあります。この場合には使用者が適切な対策を講ずるよう要求されることがあります。

**EMI Notice:** This product complies with the following domestic and international standards:

- Domestic: FCC Part 15, Class A
- International: CISPR22 (Europe EN55022 Class A).

**EC Notice:**

Warning! This is a Class A product. In a domestic environment this product may cause radio interference in which case the user may be required to take adequate measures.

Achtung! Dieses ist ein Gerät der Funkstörgrenzwertklasse A. In Wohnbereichen können bei Betrieb dieses Gerätes Rundfunkstörungen auftreten, in welchen Fällen der Benutzer für entsprechende Gegenmaßnahmen verantwortlich ist.

Attention! Ceci est un produit de Classe A. Dans un environnement domestique, ce produit risque de créer des interférences radioélectriques, il appartiendra alors à l'utilisateur de prendre les mesures spécifiques appropriées.

**ACOUSTICS:**

Preliminary declared values per ISO 9296 and ISO 7779:

	<b>Sound Power Level</b> <b><math>L_{wAd}</math>, B</b>	<b>Sound Pressure Level</b> <b><math>L_{pAm}</math>, dBA (Bystander Positions)</b>
Idle	6.5	50
Operating	6.5	50

Current values for specific configurations are available from Compaq representatives. 1 B = 10 dBA.



---

# Table of Contents

## Preface

## 1 Product Overview

1.1 Introduction .....	1-1
1.2 IP Platform Overview .....	1-1
1.2.1 IP Simplex System .....	1-2
1.2.2 IP Duplex System .....	1-2
1.2.3 Factory Installed Software .....	1-3
1.3 System Features.....	1-4
1.3.1 User Interfaces.....	1-4
1.3.2 Alarm Subsystem.....	1-4
1.3.3 Maintainability .....	1-4
1.3.4 Reliability.....	1-4
1.3.5 Upgrading.....	1-5
1.3.6 Compaq Computer Corporation and Industry Standards.....	1-5
1.3.6.1 Telecommunications Interfaces.....	1-5
1.3.6.2 Safety and Electromagnetic Compatibility .....	1-5
1.3.7 System Security .....	1-6
1.4 Required and Optional Hardware.....	1-6
1.4.1 AlphaServer 1000A System .....	1-6
1.4.1.1 Overview .....	1-6
1.4.1.2 AlphaServer 1000A Required Hardware.....	1-7
1.4.2 Modular Storage Shelf Subsystem (BA35x-Sx).....	1-8
1.4.2.1 Overview .....	1-8
1.4.2.2 Modular Storage Shelf Optional Hardware .....	1-8
1.4.3 ISA Bus Expansion Chassis .....	1-8
1.4.3.1 Overview .....	1-8
1.4.3.2 ISA Bus Expansion Chassis Required and Optional Hardware.....	1-9
1.4.4 IP Power Controller Subsystem.....	1-10
1.4.4.1 Overview .....	1-10
1.4.4.2 IP Power Controller Options.....	1-10
1.4.5 Alarm Indicator Panel.....	1-10
1.4.6 External Hardware Options.....	1-11

## 12 Installing the AlphaServer IP Platform Hardware

2.1 Introduction .....	2-1
2.2 Factory Installed Hardware .....	2-1
2.3 Site Preparation .....	2-2

2.3.1 Preinstallation Considerations .....	2-2
2.4 Hardware Installation.....	2-3
2.4.1 Installing the IP Platform .....	2-4
2.4.1.1 Connecting the Network Hardware.....	2-4
2.4.1.1.1 Connecting Dialogic D/240SC-T1 and DTI/211 T-1 Modules .....	2-5
2.4.1.1.2 Connecting Dialogic DTI/212 E-1 Modules (75-Ohm) .....	2-6
2.4.1.1.3 Connecting Dialogic DTI/212 E-1 Modules (120-Ohm).....	2-6
2.4.1.1.4 Connecting Dialogic LSI/120 Loop-Start Module.....	2-7
2.4.1.2 IP Power Controller.....	2-8
2.4.1.3 User Alarms .....	2-8
2.4.2 Locking Your System .....	2-9

### 3 Basic Operation

3.1 Introduction .....	3-1
3.2 Turning on the AlphaServer IP Platform .....	3-1
3.2.1 Step I: Power Controller Circuit Breakers .....	3-1
3.2.2 Step II: ISA Bus Expansion Chassis .....	3-1
3.2.3 Step III: AlphaServer 1000A System.....	3-1
3.3 Basic Operation of the IP Platform Subsystem Components .....	3-2
3.3.1 Alarm Indicator Panel .....	3-2
3.3.1.1 Replacing Batteries in the Alarm Indicator Panel .....	3-4
3.3.1.2 Dry Contacts .....	3-5
3.3.2 AlphaServer 1000A System .....	3-6
3.3.3 Modular Storage Shelf BA35x-Sx Subsystem .....	3-7
3.3.4 ISA Bus Expansion Chassis .....	3-8

### 4 Reconfiguring the AlphaServer IP Platform

4.1 Introduction .....	4-1
4.2 AlphaServer 1000A System Configurations .....	4-2
4.3 ISA Bus Expansion Chassis Configuration.....	4-3
4.3.1 Removing and Replacing the Alarm Sensor Module .....	4-3
4.3.2 Removing and Replacing the AT Bus Expansion Kit .....	4-4
4.4 Modular Storage Shelf BA35x-Sx Subsystem Configuration.....	4-4
4.5 Alarm Indicator Panel Configuration .....	4-5
4.5.1 Removing and Replacing the Alarm Indicator Module.....	4-5

### 5 System Troubleshooting

5.1 Introduction .....	5-1
5.2 AlphaServer 1000A Subsystem.....	5-2
5.3 Alarm Indicator Panel.....	5-2
5.4 ISA Bus Expansion Chassis .....	5-3
5.5 Modular Storage Shelf BA35x-Sx Subsystem .....	5-3
5.6 AlphaServer IP Power Controllers .....	5-3

### A AlphaServer IP Platform Specifications

A.1 Physical Dimensions .....	A-1
A.2 Electrical Specifications .....	A-1
A.3 System Environmental Specifications .....	A-2
A.4 Dry Contact Specifications .....	A-3
A.5 Central Office Compatibility.....	A-4

## B Alarm Input Wiring

B.1 Alarm Input Wiring Diagram .....	B-1
B.2 Wiring User Alarm Inputs .....	B-2

## C Field Wiring the -48 Vdc Power Inverter

C.1 Field Wiring the -48 Vdc Power Controllers .....	C-1
C.1.1 Installing Suitable Field Wiring .....	C-2

## D AlphaServer IP Platform Duplex System Diagrams

D.1 Introduction .....	D-1
D.2 AlphaServer IP Platform Duplex AC System .....	D-2
D.3 AlphaServer IP Platform Duplex DC System .....	D-4

## E AlphaServer IP Platform Simplex System Diagrams

E.1 Introduction .....	E-1
E.2 AlphaServer IP Platform Simplex AC System .....	E-2
E.3 AlphaServer IP Platform Simplex DC System .....	E-4

## Glossary

## Index

## Figures

Figure 3-1: Alarm Indicator Panel (Front and Rear View) .....	3-3
Figure 3-2: Dry Contact Terminal Connectors .....	3-6
Figure B-1: Alarm Input Wiring Diagram .....	B-1
Figure B-2: Alarm Control Module 8-Pin MJ Connector .....	B-2
Figure D-1: IP Platform Duplex AC System Front and Side View .....	D-2
Figure D-2: IP Platform Duplex AC System Rear View .....	D-3
Figure D-3: IP Platform Duplex DC System Front and Side Views .....	D-4
Figure D-4: IP Platform Duplex DC System Rear View .....	D-5
Figure E-1: IP Platform Simplex AC System Front and Side View .....	E-2
Figure E-2: IP Platform Simplex AC System Rear View .....	E-3
Figure E-3: IP Platform Simplex DC System Front and Side Views .....	E-4
Figure E-4: IP Platform Simplex DC System Rear View .....	E-5

## Tables

Table 1-1: AlphaServer 1000A Required Hardware .....	1-7
Table 1-2: Modular Storage Shelf (BA35x-Sx) Optional Hardware .....	1-8
Table 1-3: ISA Bus Expansion Chassis Required and Optional Hardware .....	1-9
Table 1-4: IP Power Controller Options .....	1-10
Table 1-5: Alarm Indicator Panel Options .....	1-10
Table 1-6: External Hardware Options .....	1-11
Table 2-1: T-1 to D/240SC-T1 Pin Designations .....	2-5
Table 2-2: T1 to DTI/211 Pin Designations .....	2-5

Table 2-3: E-1 to DTI/212 75-Ohm Pin Designations .....	2-6
Table 2-4: E-1 to DTI/212 120-Ohm Pin Designations .....	2-6
Table 2-5: LSI/120 Loop-Start 25-Pin Designations .....	2-7
Table 2-6: LSI/120 Loop-Start 50-Pin Designations .....	2-8
Table 3-1: Dry Contact Relay Functional Specification .....	3-6
Table 4-1: SRM Console Configuration Commands .....	4-2
Table A-1: Physical Dimensions.....	A-1
Table A-2: Electrical Specifications for Each Power Controller.....	A-1
Table A-3: Environmental Specifications .....	A-2
Table A-4: Dry Contact Specifications .....	A-3
Table B-1: Alarm Control Module 8-Pin MJ Connector Pinout .....	B-2
Table C-1: Field Wire Recommendations for Each Power Feed.....	C-2



---

# Preface

## About This Guide

The *AlphaServer Intelligent Peripheral Platform Hardware Owner's Guide* describes how to set up, operate, troubleshoot, and maintain an *AlphaServer Intelligent Peripheral (IP) Platform*. If information is available elsewhere, this manual provides a reference to the appropriate documentation.

## Intended Audience

This manual is intended for qualified system managers and technical end users trained in the installation and the servicing of computer systems.

## Structure of This Document

This guide is organized as follows:

**Chapter 1, Product Overview** – Describes the basic *AlphaServer IP Platform* configurations, the required and optional hardware, and the factory-installed software.

**Chapter 2, Installing the AlphaServer IP Platform Software** – Provides instructions for installing the *AlphaServer IP Platform* hardware.

**Chapter 3, Basic Operation** – Describes how to turn on the *AlphaServer IP Platform*.

**Chapter 4, Reconfiguring the AlphaServer IP Platform** – Explains how to reconfigure the *AlphaServer IP Platform*.

**Chapter 5, System Troubleshooting** – Provides basic troubleshooting information.

**Appendix A, AlphaServer Platform Specifications** – Provides system and environmental specifications.

**Appendix B, Alarm Input Wiring** – Provides a wiring diagram of all of the alarm inputs and wiring information for user alarm inputs.

**Appendix C, Field Wiring the -48 Vdc Power Inverter** – Provides field wiring details for the -48 Vdc power controllers.

**Appendix D, AlphaServer IP Platform Duplex System Diagrams** – Contains diagrams of the IP duplex platforms.

**Appendix E, AlphaServer IP Platform Simplex System Diagrams** – Contains diagrams of the IP simplex platforms.

The **Glossary** defines technical terms related to the product.

The **Index** locates the main topics in this guide.

## Conventions

This document uses the following conventions:

Convention	Meaning
<b>IP</b>	Describes an industry-standard acronym for Intelligent Peripheral.
<b>Note</b>	A note calls the reader's attention to any item of information that may be of special importance.
<b>Caution</b>	A caution contains information essential to avoid damage to the equipment.
<b>Warning</b>	A warning contains information essential to the safety of personnel.
<b>❶</b>	Circled numbers provide a link between figures or examples and text.
<i>Italic type</i>	Italic type emphasizes important information, indicates variables, and indicates complete titles of manuals.

## Related Documentation

For additional information on the *AlphaServer Intelligent Peripheral (IP) Platform* subsystem components and related software, refer to the documentation in the following table. Order numbers may change as documents are revised or updated. Check with your Compaq sales representative for additional information.

Document	Part Number
<b>AlphaServer IP Platform</b>	
<i>Intelligent Peripheral Fault Manager for Tru64 UNIX Installation and User's Guide</i>	AA-QN0FD-TE
<i>AlphaServer Intelligent Peripheral Platform System Manager's Guide</i>	AA-QU0JC-TE
<b>AlphaServer 1000A Processor</b>	
<i>AlphaServer 1000A Rackmount Owner's Guide</i>	EK-RMNOR-OG
<i>DIGITAL UNIX Installation Guide</i>	AA-QLTGB-TE
<i>StorageWorks KZPSA PCI-to-SCSI Adapter User's Guide</i>	EK-KZPSA-UG
<i>Site Environmental Preparation Guide</i>	EK-CSEPG-MA
<b>BA35x-Sx Modular Storage Shelf</b>	
<i>BA350 Modular Storage Shelf Subsystem User's Guide</i>	EK-BA350-UG
<i>BA350 Modular Storage Shelf Subsystem Configuration Guide</i>	EK-BA350-CG
<i>DWZZB SCSI Signal Converter User's Guide</i>	EK-DWZZB-UG
<i>RZ Series Disk Drive Installation Guide - Models RZ35, RZ26, RZ27, RZ28</i>	EK-DRZ01-IG
<b>-48 Vdc Power Inverter</b>	
<i>DIGITAL 2T-48VDC-xx -48Vdc-to-120Vac Power Inverter Owner's Guide</i>	EK-48VDC-OG
<b>ISA Bus Expansion Chassis</b>	
<i>I-Bus 4820 User Manual</i>	109-40020-00
<i>Dialogic Voice Hardware Reference</i>	BX-QLTUA-TE
<i>Dialogic Network Hardware Reference</i>	BX-QLTTA-TE
<i>Dialogic VR/160 Hardware Reference</i>	BX-QLTVA-TE
<i>Dialogic FAX/120 Hardware Reference</i>	BX-QLTSA-TE

## 1.1 Introduction

This chapter includes the following topics:

- IP Platform Overview
- IP Platform Features
- IP Platform Required and Optional Hardware

## 1.2 IP Platform Overview

The *AlphaServer Intelligent Peripheral (IP) Platform* provides a full suite of hardware and software components for voice processing, telephony and data communications, management, processing, and storage. These components are combined to make a high performance, high availability, rackmount-configured IP Platform, that meets certain standards and specifications.

There are two basic *AlphaServer IP Platform* configurations upon which all platform systems are built:

- IP Simplex System
- IP Duplex System

There may also be custom variations of the IP platform.

Each rackmount platform requires a console terminal to display all system alarm messages and manage alarm conditions.

Basic *AlphaServer IP Platform* management functions are designed to ensure the integrity of the platform and to allow for the management of the platform itself. The management functions include alarming based on critical events, for example; hardware failure, logging of events and activities, management of the individual resources, and system security. These functions are described in the *Intelligent Peripheral Fault Manager for Tru64 UNIX Installation and User's Guide*.

### 1.2.1 IP Simplex System

The simplex system is a central office compatible rackmount system intended for Telco central office environments. It contains *one* each of the following components:

- *AlphaServer* 1000A system running the *Compaq Tru64 UNIX* (formerly DIGITAL UNIX) operating system
- ISA bus expansion chassis
- Alarm indicator panel
- *StorageWorks* BA35x-Sx mass storage disk drive subsystem (optional)
- Rackmount power controller (120 Vac, 250 Vac, or -48 Vdc models)

Refer to Appendix E for diagrams of the IP simplex system.

### 1.2.2 IP Duplex System

The duplex rackmount configuration is a central office compatible rackmount system intended for Telco central office environments and is suitable for live network implementations. The duplex system includes *two* each of the following components:

- *AlphaServer* 1000A system running the *Tru64 UNIX* operating system
- ISA bus expansion chassis
- Alarm indicator panel
- *StorageWorks* BA35x-Sx mass storage disk drive subsystems (optional) (connected together with BN21W-0B and BN21K-XX SCSI bus cables) with disks that can be striped and/or mirrored
- Two rackmount power controllers (120 Vac, 250 Vac) or one rackmount power controller (-48 Vdc)

*TruCluster* software can be ordered separately and is recommended for enhanced availability with application-defined failover services.

Refer to Appendix D for diagrams of the IP duplex system.

### 1.2.3 Factory Installed Software

The IP platform supplied by Compaq Computer Corporation is delivered to the customer with the following factory-installed software:

- *Tru64 UNIX* operating system
- Dialogic drivers for *Tru64 UNIX* that offer the following functionality:
  - Voice processing (digitization, call control)
  - Telephony network interfaces (loop-start, T-1, E-1)
  - FAX
  - Voice recognition
- *ServerWORKS* Agent
- *Advanced File System Utilities*
- *Logical Storage Manager*
- *TruCluster Available Server* for *Tru64 UNIX* (optional)
- *Intelligent Peripheral Fault Manager (IPFM)* for the *Tru64 UNIX* operating system
- *DECEvent* Translation Utility

All systems include the IP Fault Manager software that detects various system events and performs pre-configured actions for each event.

Solution developers can also use the IP Fault Manager to display application alarmed events on the IP alarm panel and to log events. A complete description of the *IP Fault Manager* is included in *the Intelligent Peripheral Fault Manager for Tru64 UNIX Installation and User's Guide*.

For additional information on how to use the factory-installed software, refer to the individual product's documentation.

## 1.3 System Features

This section provides a brief description of the system features of the *AlphaServer IP Platform*.

### 1.3.1 User Interfaces

The *AlphaServer IP Platform* is designed to work in real-time public networks of telecommunications service providers. System and network management activities are performed by means of a separate data communications network rather than the telephony communications network (for example, voice or signaling). Both graphical user interfaces (GUIs) and character cell displays are supported, depending on the interfaces provided by the layered products on the IP Platform.

Command line or character cell displays are used for objects that do not have a GUI, or as a supplement to those with a GUI. Command line interfaces can be run over a low-speed dial-up modem with minimal communication protocol support.

### 1.3.2 Alarm Subsystem

The alarm subsystem of the *AlphaServer IP Platform* provides alarming functions to the platform. These functions include the following:

- Visual indication of an alarmed event
- Audible indication of an alarmed event
- Programmable external event notification
- Diagnostic capability
- Battery-backup for alarm indicators
- Programmable software interface with interrupt capability
- Dry contacts for remote monitoring of alarms

The alarm subsystem is comprised of two physical modules: an alarm control module that resides on the PCI bus, and an alarm indicator panel, which contains all of the visual and audible indicators.

### 1.3.3 Maintainability

All configurations are designed with front access for all user devices contained in the *AlphaServer 1000A* system, the ISA bus expansion chassis, and the modular storage shelf BA35x-Sx subsystem. All nonuser devices have rear access.

The *AlphaServer 1000A* system and the ISA bus expansion chassis are slide mounted for ease of maintenance.

The BA35x-Sx application storage disks are hot-swappable.

### 1.3.4 Reliability

Each Compaq Computer Corporation component of this system will function reliably over time as long as the hardware options used are not altered. All of the Compaq options used in the design of this system meet Compaq Computer Corporation standards for reliability. However, the reliability of the equipment supplied by other vendors is determined by the manufacturer of each device.

### 1.3.5 Upgrading

Additional hardware and software options may be added to your *AlphaServer IP Platform* components. For a complete list of available options, refer to the individual component's documentation listed in the Related Documentation section of the Preface in this guide.

---

**Important**

---

FCC and safety review is valid **only** for options listed in this guide.

---

### 1.3.6 Compaq Computer Corporation and Industry Standards

The *AlphaServer IP Platform* conforms to the industry standards outlined in the following subsections.

#### 1.3.6.1 Telecommunications Interfaces

The *AlphaServer IP Platform* conforms to the following telecommunications interface standards when Telephony boards are installed:

- T-1 (24-channel, PCM encoded analog) digital network interface
- E-1 (30-channel, PCM encoded analog) digital network interface
- Loop-start signaling
- Ground-start signaling
- E&M wink-start signaling

#### 1.3.6.2 Safety and Electromagnetic Compatibility

The *AlphaServer IP Platform* conforms to the following safety and electromagnetic compatibility standards:

- FCC Part 15, Subpart J
- CSA (Canadian Standards Association) C22.2 No. 950-93
- UL (Underwriters Laboratory) 1950
- TUV EN 60950
- CE Class A
- C-Tick Mark
- BSMI

### 1.3.7 System Security

The *AlphaServer IP Platform* contains front and rear key locking doors to limit access to system components. Each *AlphaServer IP Platform* comes with a duplicate set of front and rear door keys.

In addition, each *AlphaServer 1000A* system contains a key to lock the individual processor.

Refer to the *AlphaServer 1000A Rackmount Owner's Guide* for instructions on locking the *AlphaServer 1000A* system.

---

#### Note

---

Record the key number for each cabinet door and each CPU. Store this information in a safe place; you will need the information if replacement is necessary.

---

## 1.4 Required and Optional Hardware

This section provides a brief description of each major component of the *AlphaServer IP Platform*, and lists the required and optional hardware. Contact your Compaq sales representative for the current supported options and ordering information.

### 1.4.1 AlphaServer 1000A System

This section describes the *AlphaServer 1000A* system. It also lists the required hardware for this system.

#### 1.4.1.1 Overview

The *AlphaServer 1000A* system is an Alpha uniprocessor server running the *Tru64 UNIX* operating system. A single IP cabinet can support up to two *AlphaServer 1000A* systems. The *AlphaServer 1000A* system drives all functions within the IP Platform, including voice processing, management, and communications. In addition, application, service, and other layered software run on an *AlphaServer 1000A* system. The *AlphaServer 1000A* offers high reliability features such as ECC memory and ECC cache.

The *AlphaServer 1000A* system includes:

- 9 expansion slots: 7 PCI slots and 2 EISA slots
- 256 MB memory, expandable to 1 GB memory
- Integrated Fast-Wide Single-Ended SCSI-2 controller (supports wide and narrow drives)
- Multiple drive bays supporting a 1.44 MB floppy diskette, RRD4 x-xx CD-ROM, 1 available removable media drive bay, and 3 3.5-inch hard disks
- 2 serial ports (9-pin) and one enhanced bi-directional parallel port (25-pin)

For additional information on the *AlphaServer 1000A* system features and capabilities, see the *AlphaServer 1000A Rackmount Owner's Guide*.



### 1.4.1.2 AlphaServer 1000A Required Hardware

Table 1-1 lists the required hardware for the *AlphaServer* 1000A system. Refer to the *DIGITAL Systems and Options Catalog* for descriptions of optional hardware.

**Table 1-1: AlphaServer 1000A Required Hardware**

Part Number	Description	Simplex	Duplex
PB79D-RA	RM <i>AlphaServer</i> 1000A 5/500 <i>Tru64 UNIX</i> System, includes RX23 floppy drive	1	2
PB7MA-CE	256 MB memory	1	2
2T-VC220-IP	AT bus expansion kit (EISA/ISA module) Access I/O transmitter and receiver modules and 2-meter cable	1	2
2T-IPCON-AA	Alarm control module	1	2
RZ1CB-BS	4.3 GB SCSI hard disk drive	1	2
	<b>Note:</b> Each <i>AlphaServer</i> 1000A system in the simplex and duplex configurations are preconfigured with one wide disk for system files and data		
RRD47-AA	32 X CD-ROM drive	1	2
PBXTL-DA	8.0 GB SCSI 4 mm DAT drive	1	2

## 1.4.2 Modular Storage Shelf Subsystem (BA35x-Sx)

This section provides a brief description of the modular storage shelf subsystem.

### 1.4.2.1 Overview

The *StorageWorks* disk drive subsystem is a rackmount storage resource provided to solution developers and service developers creating applications on the *AlphaServer IP Platform*. The shelves are contained in a separate chassis that provides a flexible capacity for adding and hot-swapping disks.

The shelf is a self-contained unit with embedded backplane routing with two SCSI buses. It can be configured for maximum connectivity (1 SCSI bus) or for maximum performance (2 SCSI buses).

Each *StorageWorks* modular storage shelf houses all the application storage disks in a rackmount shelf. The following table lists the type of disks that can be used. For additional information, see the *BA350 Modular Storage Shelf Subsystem Configuration Guide*.

### 1.4.2.2 Modular Storage Shelf Optional Hardware

Table 1-2 lists the hardware options for the BA35x-Sx modular storage shelf.

**Table 1-2: Modular Storage Shelf (BA35x-Sx) Optional Hardware**

Part Number	Description
BA35x-Sx	Rackmount <i>StorageWorks</i> in BA35x-Sx enclosure.
DS-RZ1CF-VW	<i>StorageWorks</i> disks for BA35x enclosure. 4.3 GB disks.
DWZZB-VW	Fast, wide, differential to single ended SCSI converter for BA35x-Sx. Terminates SCSI bus at storage unit.
KZPSA-BB	Fast, wide, differential SCSI controller.
H885-AA	Tri-link connector block.
H879-AA	SCSI terminator.

## 1.4.3 ISA Bus Expansion Chassis

This section describes the ISA bus expansion chassis.

### 1.4.3.1 Overview

The *I-Bus 4820-2819* enclosure is used as a 20-slot ISA bus expansion chassis for the *AlphaServer 1000A* system. The ISA bus expansion chassis contains all Dialogic voice modules for its associated *AlphaServer 1000A* simplex and duplex systems. The *I-Bus 4820-2819* enclosure contains an alarm sensor module which monitors temperature, dc power, and cooling fan rotation. If any of these reach a point of failure, an alarm signal is sent to the *AlphaServer 1000A*.

The ISA bus expansion chassis connects to the *AlphaServer 1000A* system as follows:

- The ISA bus expansion chassis connects to the *AlphaServer 1000A* EISA bus by means of the AT (ISA) bus expansion kit (PN 2T-VC220-IP).
- The ISA bus expansion chassis alarm inputs connect to the *AlphaServer 1000A* system by means of a cable.

### 1.4.3.2 ISA Bus Expansion Chassis Required and Optional Hardware

The ISA bus expansion chassis connects to the *AlphaServer 1000A* EISA bus by means of the AT (ISA) bus expansion kit. The AT (ISA) bus expansion kit includes transmitter and receiver modules and an interconnecting cable. The transmitter module resides in the *AlphaServer 1000A* system, the receiver module resides in the ISA bus expansion chassis, and the cable connects both modules.

Table 1-3 contains the required and optional hardware for the ISA bus expansion chassis. All hardware listed in Table 1-3 can be ordered separately as spare parts.

**Table 1-3: ISA Bus Expansion Chassis Required and Optional Hardware**

Part Number	Description	Simplex	Duplex
2T-VC221-IB	ISA bus expansion chassis	1	2
2T-VC220-IP <sup>2</sup>	Access I/O AT bus expansion kit with 2-meter cable	1	2
2T-LDMOD-AA	Load module	1	2
2T-VC24T-xx <sup>1</sup>	Diallogic D/240SC-T1, 24-channel, high-density voice-processing and network-interface module	Opt	Opt
2T-VC211-xx <sup>1</sup>	Diallogic DTI/211, 24-channel, standard-density, T-1 network-interface module	Opt	Opt
2T-VC212-xx <sup>1</sup>	Diallogic DTI/212, 30-channel, standard-density, E-1 network-interface module	Opt	Opt
2T-VC320-xx <sup>1</sup>	Diallogic D/320SC, 32-channel, high-density, voice-processing module	Opt	Opt
2T-VCLSI-xx <sup>1</sup>	Diallogic LSI/120, 12-channel, standard-density, analog loop-start network-interface module	Opt	Opt
2T-VC121-xx <sup>1</sup>	Diallogic D/121B, 12-channel, standard-density, analog loop-start call-processing module	Opt	Opt
2T-VCFAX-xx <sup>1</sup>	Diallogic FAX/120, 12-channel, standard-density, FAX processing module	Opt	Opt
2T-VCF4E-xx <sup>1</sup>	Diallogic VFX/40E, 4-channel, low-density, analog loop-start call-processing and 14,400 b/s FAX processing module	Opt	Opt
2T-VCVRP-xx <sup>1</sup>	Diallogic VRP, 4/8/12/16-channel, standard-density, voice-recognition module	Opt	Opt
2T-VCVR4-xx <sup>1</sup>	Diallogic VRM/40, 4-channel, discrete voice-recognition daughterboard	Opt	Opt
2T-VCVR2-xx <sup>1</sup>	Diallogic VRM/2C, 2-channel, continuous voice-recognition daughterboard	Opt	Opt
2T-VCDMX-xx <sup>1</sup>	Diallogic DMX: Digital Matrix Switch connecting up to four PCM expansion buses (PEBs)	Opt	Opt

<sup>1</sup> xx represents a two-letter country code. Contact your Compaq sales representative for additional information.

<sup>2</sup> Confirm that there are no cards in the ISA bus expansion chassis that use the Compressed Write Timing ("zero-wait-state") signal. The 2T-VC220-IP option does not service this signal.

#### Note

The list of supported options is updated on a regular basis. Please contact your Compaq sales representative for a current list of supported options.

## 1.4.4 IP Power Controller Subsystem

This section briefly describes the IP power controller subsystem.

### 1.4.4.1 Overview

Each rackmount simplex and duplex IP Platform contains one or two power controllers located in the bottom rack of the cabinet. Each controller provides power to one ISA bus expansion chassis, one BA35x-Sx modular storage shelf, and one *AlphaServer* 1000A processor.

The *AlphaServer IP Platform* supports the following power controller models: 120 Vac, 250 Vac, or -48 Vdc. In addition, each processor and associated voice, storage, and communication resource has its own individual power supply.

Refer to Appendix C for instructions on field wiring the -48 Vdc power controllers for power.

### 1.4.4.2 IP Power Controller Options

Table 1-4 lists the IP power controller options.

**Table 1-4: IP Power Controller Options**

Part Number	Description	Simplex	Duplex
H7600-AA	120 Vac power distribution unit that provides ten (10) ac outlets, an attached power cord with an L5-30P plug, an on/off circuit breaker, and a power-on light.	1	2
H7600-DB	250 Vac power distribution unit that provides twelve (12) IEC 320 ac outlets, an attached power cord with an IEC 309 plug, an on/off circuit breaker, and a power-on light.	1	2
2T-48VDC-AA	3 kW (N+1) -48 Vdc power inverter (-48 Vdc to 120 Vac dual converter).	0	1
2T-48VDC-AB	2 kW (N+1) -48 Vdc power inverter (-48 Vdc to 120 Vac dual converter).	1	0

## 1.4.5 Alarm Indicator Panel

The alarm indicator panel provides programmable visual and audible alarm indicators for the IP Platform.

Table 1-5 lists the alarm indicator panel options.

**Table 1-5: Alarm Indicator Panel Options**

Part Number	Description	Simplex	Duplex
2T-IPAIP-CA	Alarm indicator panel for the simplex IP Platforms.	1	NA
2T-IPAIP-CB	Alarm indicator panel for the duplex IP Platforms.	NA	1

### 1.4.6 External Hardware Options

Table 1-6 contains external hardware options.

**Table 1-6: External Hardware Options**

<b>Part Number</b>	<b>Description</b>
LA75S-AA	<i>LA75 Plus Companion</i> printer for hardcopy system output
FR-B16AP-EG (or equivalent)	Personal computer for <i>ServerWORKS</i>
VT520, VT525 (or equivalent)	Console terminal



---

# Installing the AlphaServer IP Platform Hardware

## 2.1 Introduction

This chapter includes the following topics:

- Factory installed hardware
- Site preparation
- Hardware installation

## 2.2 Factory Installed Hardware

The *AlphaServer Intelligent Peripheral (IP) Platform* is configured and delivered according to customer specification, with all hardware and software factory-installed. It is shipped ready for connection to a customer's power source and network hardware.

---

**Note**

---

Value-added Implementation Services (VIS) is available for the *AlphaServer IP Platform* products. VIS provides high-quality integration, test verification, and site installation; each process is performed by experienced service personnel. See your Compaq sales representative for additional information.

---

## 2.3 Site Preparation

This section describes the site-specific installation requirements for the IP Platform.

---

### Caution

---

Review your system warranty. It may require that a Compaq service representative install your system to prevent damage to equipment or software.

---

---

### Achtung

---

Überprüfen Sie die Garantie Ihres Systems. Eventuell muß Ihr System, gemäß der Garantie, vom Compaq-Kundendienst installiert werden, um Beschädigungen am Gerät oder an der Software zu verhindern.

---

### 2.3.1 Preinstallation Considerations

Before you install the *AlphaServer IP Platform*, ensure that:

- The installation site meets the specifications and environmental conditions listed in Appendix A. For more information about planning and preparing the installation site for a computer network for a free-standing system, refer to the *Site Environmental Preparation Guide*. (PN EK-CSEPG-MA. Available by calling 1-800-344-4825.)
- The power source is correct for your system, and is one of the following models: 120 Vac, 250 Vac, or -48 Vdc.
- You have the correct number of T-1, E-1, or loop-start network connections and adequate cabling.

---

### Note

---

The T-1 cable length from the network to the *AlphaServer IP Platform* cannot exceed 199.6 m (655 ft) without a repeater. Do **not** use a repeater for cable lengths less than 199.6 m (655 ft).

---

- The system is located in an area that provides 61 cm (24 in.) clearance from the rear of the cabinet, and 76.2 cm (30 in.) from the front of the cabinet for ventilation and servicing.
- Personnel are appropriately trained in the installation and operation of this system.



## 2.4 Hardware Installation

This section describes the installation and setup of the IP Platform.

---

### WARNING

---

**Only a qualified service person should install the system. A qualified service person is an individual who has the technical training and experience to be aware of the:**

- **Hazards to which they are exposed in performing a task**
- **Measures to minimize the danger to themselves or other persons**

**A qualified service person need not be a Compaq service representative.**

---

---

### VORSICHT

---

**Das System darf nur von qualifizierten Fachleuten installiert werden. Qualifizierte Fachleute sind Personen, die entsprechend technisch geschult sind und über die nötige Erfahrung verfügen, um:**

- **die Gefahren zu erkennen, denen sie bei der Ausführung der Arbeit ausgesetzt sein könnten**
- **die notwendigen Maßnahmen zur Minimierung der Gefahr für sie selbst und für andere Personen zu ergreifen.**

**Qualifizierte Fachleute sind nicht notwendigerweise Fachleute des Compaq-Kundendienstes.**

---

### 2.4.1 Installing the IP Platform

After you have verified the installation site, install the *AlphaServer IP Platform* by performing the following steps:

1. Position the cabinet, allowing a 60.96 cm (24 in) minimum rear aisle clearance and a 76.2 cm (30 in) minimum front aisle clearance.
2. Level the cabinet using the four-point leveling hardware.
3. If a -48 Vdc power inverter is installed in the platform, bolt the *AlphaServer IP Platform* to the floor at the cabinet base using the front and rear shipping brackets (and optionally at the top, using the appropriate central office conforming hardware). Local codes may prohibit bolting the cabinet to the floor if H7600 power distribution units are installed.
4. Connect to the network hardware (see Section 2.4.1.1).
5. Connect the IP Platform to the appropriate power supply. See Appendix C for instructions on wiring the -48 Vdc controllers if your system has them installed. Refer to the power ratings listed on the cabinet part number label located at the rear of the cabinet above the door.
6. Verify the hardware setup. Before you turn on the system, check to ensure that the IP Platform is properly secured, and the power controller and network hardware connections are correct.
7. Power up the system. See Section 3.2.

#### 2.4.1.1 Connecting the Network Hardware

This section describes how to install Dialogic's voice-processing, voice-recognition, and network-interface T-1, E-1, and loop-start modules to the building's network hardware.

Refer to the *Dialogic Network Hardware Reference* and the *Dialogic Voice Hardware Reference* for diagrams of the Dialogic modules and for additional information on the Dialogic modules. All Dialogic modules are installed in the ISA bus expansion chassis.

#### 2.4.1.1.1 Connecting Dialogic D/240SC-T1 and DTI/211 T-1 Modules

On the rear bracket of the D/240SC-T1 and DTI/211 network modules is an RJ-48C jack for connecting to the T-1 network. The cabling between this jack and the CSU or other DSX-1 equipment should be 4-pair telephone line or equivalent. The network interface module of the cable should consist of an RJ-48C plug. The user is responsible for supplying an appropriate cable for these connections. The pin designations for the network interface module cable end for D/240SC-T1 modules are specified in Table 2-1.

**Table 2-1: T-1 to D/240SC-T1 Pin Designations**

Signal	Pin(s)
Receive ring: input to network interface module	1
Receive tip: input to network interface module	2
No connection	3, 6
Transmit ring: output from network interface module	5
Transmit tip: output from network interface module	4
Optional shield	7, 8

The pin designations for the network interface module cable end for DTI/211 T-1 modules are specified in Table 2-2.

**Table 2-2: T1 to DTI/211 Pin Designations**

Signal	Pin(s)
Receive ring: input to network interface module	1
Receive tip: input to network interface module	2
No connection	3, 6
Transmit ring: output from network interface module	4
Transmit tip: output from network interface module	5
Optional shield	7, 8

Refer to the *Dialogic Network Hardware Reference* for additional information on DTI/211 T-1 modules. Refer to the *Dialogic Voice Hardware Reference* for additional information on D/240SC-T1 modules.

### 2.4.1.1.2 Connecting Dialogic DTI/212 E-1 Modules (75-Ohm)

The Dialogic DTI/212 E-1 modules come in 75-ohm and 120-ohm versions. If you have a DTI/212 120-ohm module, see Section 2.4.1.1.3. Refer to the *Dialogic Network Hardware Reference* for additional information on DTI/212 E-1 modules.

On the rear bracket of the DTI/212 75-ohm module are two BNC-type jacks for connecting to the external E-1 network. The cabling between these jacks and the external E-1 network should be 75-ohm coaxial. The DTI/212 end of the cable should consist of a BNC-type male connector. The user is responsible for supplying an appropriate cable for these connections. The pin designations for the DTI/212 75-ohm cable ends are given in Table 2-3.

**Table 2-3: E-1 to DTI/212 75-Ohm Pin Designations**

Signal	Jack/Pin
Transmit data: output from DTI/212 (tip)	J201A center
Transmit data: output from DTI/212 (ring)	J201A shield
Receive data: input to DTI/212 (tip)	J201B center
Receive data: input to DTI/212 (ring)	J201B shield

To cable the DTI/212 75-ohm module to the E-1 network, follow these steps:

1. Attach the appropriate end of the E-1 to DTI/212 (receive) cable to jack J201B on the rear bracket of the DTI/212 module. Carefully push the BNC connector onto the jack and lock by turning a quarter-turn clockwise.
2. Attach the appropriate end of the DTI/212 to E-1 (transmit) cable to jack J201A on the rear bracket of the DTI/212 module. Carefully push the BNC connector onto the jack and lock by turning a quarter-turn clockwise.

### 2.4.1.1.3 Connecting Dialogic DTI/212 E-1 Modules (120-Ohm)

On the rear bracket of the DTI/212 120-ohm module is an RJ-48C jack for connecting to the external E-1 network. The cabling between this jack and the CSU should be 120-ohm twisted pair or equivalent. The DTI/212 120-ohm end of the cable should consist of an RJ-48C plug. The user is responsible for supplying an appropriate cable for these connections. The pin designations for the DTI/212 120-ohm cable ends are given in Table 2-4.

**Table 2-4: E-1 to DTI/212 120-Ohm Pin Designations**

Signal	Pin(s)
Receive ring: input to the DTI/212 120-ohm module	1
Receive tip: input to the DTI/212 120-ohm module	2
No connection	3, 6
Transmit ring: output from the DTI/212 120-ohm module	5
Transmit tip: output from the DTI/212 120-ohm module	4
Optional shield	7, 8

To cable the DTI/212 120-ohm module to the E-1 network, follow these steps:

1. Align the RJ-48C connector at the DTI/212 120-ohm module end of the E-1 to DTI/212 120-ohm cable with jack J201 on the rear bracket of the DTI/212 module.
2. Gently push the cable connector into the RJ-48C jack until it snaps into place.

### 2.4.1.1.4 Connecting Dialogic LSI/120 Loop-Start Module

The customer is responsible for supplying additional cabling to connect the LSI/120 network interface module to the telephone company lines.

Refer to the *Dialogic Network Hardware Reference* for additional information on LSI/120 modules.

You can choose from the following connection options:

- Use Compaq's BC22F cable. This cable has a DB-25 connector on one end (to connect to the LSI/120), and a 50-pin connector on the other end that provides 12 tip and ring pin pairs that are compatible with a standard RJ-21X USOC jack.
- Use Dialogic's SA/120 RJ-11 assembly. This assembly accepts the 50-pin male connector from the SA/120 RJ-21 cable and terminates with 12 RJ-11 connectors. This cable allows you to connect individual subscriber lines to the LSI/120.

The pin-out specifications in Table 2-5 and Table 2-6 are for connector P3 on the LSI/120. This cable uses a 25-pin female DB-25 connector (Amphenol part number 745495-2 or equivalent) on the LSI/120 end, and a 50-pin jack (Amphenol part number 157-72500-3 or equivalent) that is compatible with an RJ-21X USOC jack.

**Table 2-5: LSI/120 Loop-Start 25-Pin Designations**

TIP 8	1	14	RING 12
RING 8	2	15	TIP 12
TIP 9	3	16	RING 11
RING 9	4	17	TIP 11
TIP 4	5	18	RING 10
RING 4	6	19	TIP 10
TIP 7	7	20	TIP 3
RING 7	8	21	RING 3
TIP 6	9	22	RING 1
RING 6	10	23	TIP 1
TIP 5	11	24	RING 2
RING 5	12	25	TIP 2
RESERVED	13		

**Table 2-6: LSI/120 Loop-Start 50-Pin Designations**

RING 1	1	26	TIP 1
RING 2	2	27	TIP 2
RING 3	3	28	TIP 3
RING 4	4	29	TIP 4
RING 5	5	30	TIP 5
RING 6	6	31	TIP 6
RING 7	7	32	TIP 7
RING 8	8	33	TIP 8
RING 9	9	34	TIP 9
RING 10	10	35	TIP 10
RING 11	11	36	TIP 11
RING 12	12	37	TIP 12
RING NC	13	38	TIP NC
RING NC	14	39	TIP NC
RING NC	15	40	TIP NC
RING NC	16	41	TIP NC
RING NC	17	42	TIP NC
RING NC	18	43	TIP NC
RING NC	19	44	TIP NC
RING NC	20	45	TIP NC
RING NC	21	46	TIP NC
RING NC	22	47	TIP NC
RING NC	23	48	TIP NC
RING NC	24	49	TIP NC
RING NC	25	50	TIP NC

### 2.4.1.2 IP Power Controller

The *AlphaServer IP Platform* supports the following power controller models: 120 Vac, 250 Vac, or -48 Vdc. Each simplex and duplex rackmount system has one or two power controllers located in the bottom of the cabinet. Each controller supports one BA35x-Sx, ISA bus expansion chassis, and an *AlphaServer 1000A* system.

Instructions for wiring the -48 Vdc power controllers to the building's power source are included in Appendix C.

### 2.4.1.3 User Alarms

If the *AlphaServer IP Platform* does not use the -48 Vdc power controller, the user can connect up to three external TTL signal alarms to the 8-pin MJ connector on the alarm control module. Refer to Appendix B for a pinout of this connector and the *Intelligent Peripheral Fault Manager for Tru64 UNIX Installation and User's Guide* for information on configuring these alarms.

## 2.4.2 Locking Your System

The *AlphaServer IP Platform* is protected by a key lock in the front and rear door panels. Duplicate interchangeable sets of keys are provided for both front and rear locks.

The *AlphaServer 1000A* system also comes with a set of keys for each CPU.

---

### Note

---

Store the keys in a safe place. Record the key number for each cabinet door and each CPU. Store this information in a safe place; you will need the information if replacement is necessary.

---

The *AlphaServer 1000A Rackmount Owner's Guide* contains additional information about the *AlphaServer 1000A* locking procedure.





## 3.1 Introduction

This chapter describes:

- Turning on the *AlphaServer IP Platform*
- Basic operation of the IP Platform subsystem components

## 3.2 Turning on the AlphaServer IP Platform

After the *AlphaServer IP Platform* is properly secured, plugged in, and connected to the building's network hardware, you are ready to power up the system. Refer to Appendix D and Appendix E for the IP Platform diagrams to assist you in locating the system components.

### 3.2.1 Step I: Power Controller Circuit Breakers

Prior to turning on the circuit breakers for the 120 Vac or 250 Vac controllers, ensure that the neon indicator is on, indicating that an ac voltage is present. The -48 Vdc controller does not have an indicator for voltage; it should be connected to the -48 Vdc battery/power source prior to turning on the circuit breakers.

To start powering up the *AlphaServer IP Platform*, switch the circuit breakers at each power controller (located in the rear of the cabinet) to the on position. The modular storage shelf BA35x-Sx automatically powers up.

### 3.2.2 Step II: ISA Bus Expansion Chassis

To power up the ISA bus expansion chassis, press the On/Off switch on the front of the ISA bus expansion chassis. The green ON/Off indicator on the front of the ISA bus expansion chassis will illuminate.

### 3.2.3 Step III: AlphaServer 1000A System

Turn the *AlphaServer 1000A* system on by pressing the On/Off switch on the front of the *AlphaServer 1000A* unit. The green On/Off indicator on the front of the system will illuminate.

At this point in the IP Platform power on sequence, the alarm indicator panel should have the green OK LED lit and the status display will contain either a “b” indicating discharged or partially charged batteries, or it will be blank.

As described in the following sections, each subsystem within the IP Platform initiates its own self-test at power-up. The following sections describe what a successful power-up of the subsystem components looks like.

### 3.3 Basic Operation of the IP Platform Subsystem Components

The following sections describe the basic operation of the IP Platform subsystem components.

#### 3.3.1 Alarm Indicator Panel

The alarm indicator panel (see Figure 3-1) contains the following:

- Visual indicators
- Audible indicator
- Battery backup logic
- Keep-alive function
- Dry contacts

##### Visual Indicators

The alarm indicator panel has three alarm LED indicators. These LED indicators are defined as follows:

- Critical (red LED)
- Major (red LED)
- Minor (amber LED)

The LED for a particular level of severity will be lit as long as at least one event of that level is active. Multiple LEDs may be simultaneously lit.

The alarm indicator panel has two other indicators used for status information. These are the following:

- Status display
- Alarm indicator panel OK LED (green)

The status display is used to output status as a result of the diagnostic testing and to display other status information as shown in the following tables.

The OK LED is lit after a successful reset and will remain lit until either an unsuccessful reset or a loss of battery power occurs.

Refer to the *Intelligent Peripheral Fault Manager For Tru64 UNIX Installation and User's Guide* for additional information on the alarm indicator panel and fault management.

---

##### Note

---

The alarm indicator panel should not be permanently removed without de-configuring it in the Intelligent peripheral Fault Manager (IPFM) config file. Refer to the *Intelligent Peripheral Fault Manager for Tru64 UNIX Installation and User's Guide*.

---

The following table describes the normal conditions of the alarm indicator panel when the *AlphaServer 1000A* is powered on and the *Intelligent Peripheral Fault Manager (IPFM)* software is running.

Condition	OK LED	Minor Alarm LED	Status Display	Audible Alarm
Fully discharged batteries	On	Off	“b”	Off
Fully charged batteries	On	Off	“Rotating bar”	Off
Partially charged batteries	On	Off	“b”	Off
Software Diagnostics	On	Off	“d”	Off
Software Test	On	Off	“t”	Off

If the *AlphaServer 1000A* system loses power while the *IPFM* software is running, the following table describes the possible conditions of the alarm indicator panel.

Condition	OK LED	Minor Alarm LED	Status Display	Audible Alarm
Fully discharged batteries	Off	Off	blank	Off
Fully charged batteries	On	On	“p”	On
Partially charged batteries	On	On	“b”	On

Figure 3-1 shows a front and rear view of the alarm indicator panel.

**Figure 3-1: Alarm Indicator Panel (Front and Rear View)**

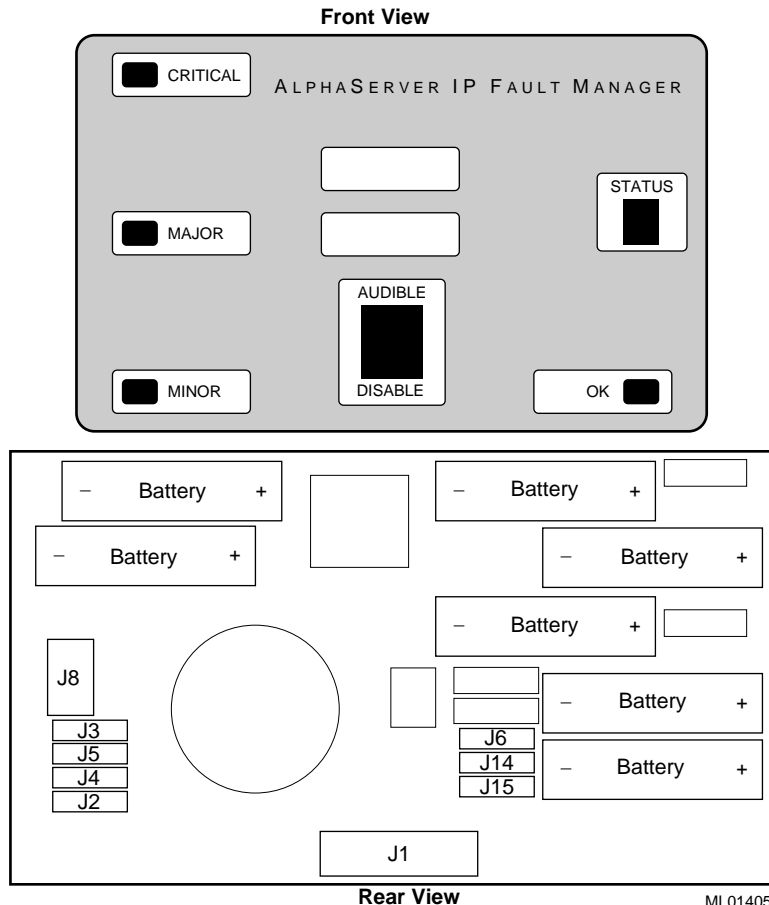

### **Audible Indicator**

The audible indicator has three distinct sounds associated with the three levels of alarming. This indicator is controlled by software through the alarm control module or by a disable switch on the alarm indicator panel itself. The audible indicator will sound at the level of the most severe alarmed event that is currently active. No more than one level of audible alarm can be enabled at any one time. The disable switch turns off the current audible alarm until a new event occurs that is of equal or greater severity level than the highest level alarm currently active, or until the event causing the audible alarm is cleared and another alarmed event is pending.

The three audible alarm levels are defined as follows:

- Critical is two beeps, the first separated from the second by 0.5 seconds or less. This double beep pattern is repeated every 1.5 seconds.
- Major is one beep every 1.5 seconds.
- Minor is one beep every 5 seconds.

### **Battery Backup Logic**

The battery backup logic is designed to keep the current indicator status functioning for the life of the batteries (approximately 60 to 120 minutes) in the event of a power failure. It provides an indication if the batteries are low by displaying a “b” in the status display.

### **Keep-Alive Function**

The alarm indicator panel houses a timer that is used to ensure that the CPU controlling it is still running. The function is enabled by software, which starts a timer. As long as software resets the timer before expiration, a “rotating bar” is displayed in the status display, otherwise a minor alarm is generated. A minor alarm will also be generated if power to the alarm indicator panel is lost and a “p” will be displayed in the status display.

#### **3.3.1.1 Replacing Batteries in the Alarm Indicator Panel**

The alarm indicator panel contains seven 1.2 V, 600 mA, NICD type AA rechargeable batteries that provide battery backup for providing alarm information when the system loses power or is turned off. When an alarm indicator panel continuously indicates a low battery condition in the absence of a power loss, the batteries should be replaced. These batteries should be replaced only with the same type batteries (PN 12-41230-04) or the equivalent batteries.

---

#### **Note**

---

Compaq recommends that batteries be replaced every two to two and a half years as preventative maintenance.

---

Perform the following procedure to replace the batteries in an alarm indicator panel:

1. Power down the *AlphaServer 1000A* system.
2. At the front of the cabinet, remove the four screws that secure the alarm indicator panel frame to the front rails.
3. Disconnect the miniature 26-pin cable(s) from the connector(s) on the rear of the alarm indicator panel(s).
4. On the rear of the alarm indicator panel that indicates a low battery condition, remove the two screws that secure the miniature 26-pin connector to the rear cover.

5. Remove the three screws from the top edge and the three screws from the bottom edge of the alarm indicator panel frame that secure the alarm indicator panel rear cover.
6. Remove the alarm indicator panel rear cover.
7. Remove the seven batteries from the battery holders.

---

**WARNING**

---

**Replace the batteries with the same type (PN 12-41230-04) or an equivalent type recommended by the battery manufacturer. Danger of explosion exists if batteries are incorrectly replaced. Discard used batteries according to battery manufacturer instructions. Be certain to follow any applicable country, state, or local statutes for proper battery disposal.**

---



---

**VORSICHT**

---

**Ersetzen Sie die Batterien nur durch Batterien des gleichen (PN 12-41230-04) oder ähnlichen Typs, so wie es vom Hersteller empfohlen wird. Wenn Sie die Batterien falsch auswechseln, besteht Explosionsgefahr. Folgen Sie bei der Beseitigung der alten Batterien sowohl den Anweisungen des Batterieherstellers als auch den jeweiligen länderspezifischen bzw. lokalen Vorschriften zur richtigen Batteriebeseitigung.**

---

8. Observing proper polarity, install the seven new batteries in the battery holders.

After installing the new batteries, reverse steps 1 through 6.

### 3.3.1.2 Dry Contacts

The dry contacts terminal connectors (see Figure 3-2) are located on the rear panel of the alarm display unit. The four contacts on the input terminal block correspond to Critical, Major, Minor, and Audio Shut-off alarm inputs. The output terminal block contacts correspond to Critical, Major, Minor, and Audio Shut-off alarm outputs. These terminal blocks can be used to connect remote alarm indicators. When an alarm condition occurs, the corresponding relay is closed to connect a voltage on the input terminal to a remote alarming device on the output terminal. See Table 3-1 for the dry contact relay functional specification. Additionally, an audible alarm can be remotely disabled by connecting to the Shut-off Alarm contacts. Refer to Appendix A for the dry contact electrical specifications.

**Figure 3-2: Dry Contact Terminal Connectors**

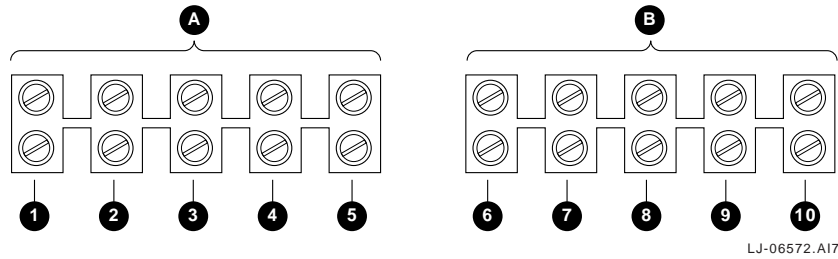

- |  |  |
|--|--|
| <p><b>A</b> Input Terminal Block</p> <ul style="list-style-type: none"> <li><b>1</b> Ext. Critical Alarm</li> <li><b>2</b> Ext. Major Alarm</li> <li><b>3</b> Ext. Minor Alarm</li> <li><b>4</b> Ext. Shut-off Alarm</li> <li><b>5</b> Ground</li> </ul> | <p><b>B</b> Output Terminal Block</p> <ul style="list-style-type: none"> <li><b>6</b> Critical Alarm</li> <li><b>7</b> Major Alarm</li> <li><b>8</b> Minor Alarm</li> <li><b>9</b> Shut-off Alarm</li> <li><b>10</b> Ground</li> </ul> |
|--|--|

**Table 3-1: Dry Contact Relay Functional Specification**

Power	Condition	Relay State		
		Critical	Major	Minor
On	No alarm	Open	Open	Open
	Critical	Closed	Open	Open
	Minor	Open	Open	Closed
	Major	Open	Closed	Open
Off	Battery OK	Open	Open	Closed
	Battery NOK	Closed	Closed	Closed

### 3.3.2 AlphaServer 1000A System

Once the *AlphaServer 1000A* system power is turned on, the screen on the IP Platform console displays test codes and initialization messages. When the startup procedure is complete, the following occurs:

- The IP Platform console terminal emulation window displays the SRM console prompt (>>>).
- The operator control panel on the front of the *AlphaServer 1000A* system displays the message "Model 5/500."

Boot the *Tru64 UNIX* system by typing boot at the console prompt. For duplex systems, type boot at each processor window. The *AlphaServer 1000A* system has booted successfully when the *Tru64 UNIX* prompt (#) appears.

Refer to the *DIGITAL UNIX Installation Guide* for installation instructions on booting a *Tru64 UNIX* system.

Refer to the *AlphaServer 1000A Rackmount Owner's Guide*, for additional information on the operation of the *AlphaServer 1000A* system.

### 3.3.3 Modular Storage Shelf BA35x-Sx Subsystem

There may be up to eight *StorageWorks* building blocks (SBBs) on each modular storage shelf BA35x-Sx subsystem. The *StorageWorks* Building Block (SBB) slots are numbered 0 through 7 from right to left with the power supply SBB in slot 7. On the IP simplex system, the storage SBBs are in slots 0-6. On the duplex system, the available storage SBBs are in slots 0-5.

---

**Note**

---

The SCSI address for the SSB device is defined automatically by the SSB slot location.

---

After power is supplied to the IP Platform, observe the status LEDs for the following successful indications:

- On a power supply SBB, both green status LEDs should be on.
- On a storage SBB, the green device activity LED is either on, flashing, or off. The amber device fault LED is off.

Additional information on the following modular storage shelf BA35x-Sx components can be found in the *BA350 Modular Storage Shelf Subsystem User's Guide*.

- Component functions
- Shelf status
- Power unit status
- Storage device status
- StorageWorks building block SSB replacement procedures
- Shelf replacement procedures
- Power supplies
- SCSI buses

### 3.3.4 ISA Bus Expansion Chassis

The *AlphaServer IP Platform* supports a variety of voice/telephony options through the addition of an ISA bus expansion chassis. The ISA bus expansion chassis is configured with a 20-slot ISA backplane. The EISA to ISA bridge uses one slot and the remaining 19 slots are available for telephony options. The ISA bus expansion chassis has the following characteristics:

- Conforms to ISA bus specifications
- Contains an ON/Off power switch for removing power for servicing
- Contains an alarm sensor module for monitoring
  - Chassis temperature
  - Chassis voltage
  - Cooling fan rotation
- Connector for communication with the alarm control module installed in the *AlphaServer 1000A* system
- Slide mounted to allow front access to all modules
- 430 W power supply to support maximum output voltages (to voice boards) and capacities as shown in the following table.

<b>Voltage</b>	<b>Amps*</b>
5	70
-5	1.0
12	5.0
-12	1.0

\* Provided that the maximum output power does not exceed the power supply rating.

- Contains a load module to provide minimum power supply pre-load (4.2 A @ +5 V). This module may be removed from the ISA bus expansion chassis when the minimum power supply pre-load can be attained with the installed telephony options.

Each simplex system contains one ISA bus expansion chassis. Each duplex system contains two ISA bus expansion chassis. A connector on the alarm control module is dedicated to bringing in physical alarm signals from the ISA bus expansion chassis. Any of the alarm events listed above cause the alarm subsystem to generate an interrupt to the system software in order to update the alarm database and also send alarm signals to the alarm indicator panel for display.



---

# Reconfiguring the AlphaServer IP Platform

## 4.1 Introduction

In order to upgrade the *AlphaServer IP Platform* or replace defective parts, you need to remove and install components within the IP Platform. These components are within the individual *AlphaServer 1000A* system, ISA bus expansion chassis, and modular storage shelf BA35x-Sx subsystems. After you change any IP Platform component, you may want to verify or modify the system configuration.

This chapter lists the components of the IP Platform subsystem that may need to be removed or installed, and the procedure for viewing and modifying the subsystem configurations using the IP Platform console terminal SRM commands.

Before you attempt to install third-party devices inside your system unit, check with the third-party vendor to ensure that your system hardware and operating system software support the device.

---

### Caution

---

Static electricity can damage electronic components. Use the antistatic wriststrap located in the inside rear cabinet door pocket. Additionally, use an antistatic mat when you handle internal components.

---

---

### Achtung

---

Elektrostatische Entladungen könnten elektronische Komponenten beschädigen. Tragen Sie deshalb das Antistatikarmband, das sich in der Tasche an der Innenseite der hinteren Gehäuseklappe befindet. Außerdem sollten Sie bei der Berührung von internen Komponenten eine Antistatikmatte benutzen.

---

## 4.2 AlphaServer 1000A System Configurations

The components of the *AlphaServer 1000A* system that may need to be replaced or upgraded include:

- Storage devices (DAT tape drive, hard disk drive, floppy drive, CD-ROM drive)
- Memory modules
- CPU motherboard
  - EISA modules
  - DExxx Ethernet controller \*
  - Access I/O transmitter module (AT bus expansion kit) \*
  - PCI modules
- \* KZPSA-BB SCSI controller (qty=2) (optional)
- \* Alarm control module
- Power supply

The KZPSA-BB PCI-to-SCSI adapter comes with its own utilities diskette that can be used to modify the adapter parameters. See the *StorageWorks KZPSA PCI-to-SCSI Storage Adapter User's Guide* for a complete description of the adapter.

After modifying the above components, and before you boot the *Tru64 UNIX* operating system, you can use the SRM console commands from the IP Platform console terminal to examine the system configurations of these components, and make modifications if necessary.

The EISA Configuration Utility (ECU) *must* be run whenever you add, remove, or move an EISA or ISA card within the *AlphaServer 1000A* system. The ECU is a menu-based utility run from the SRM console that provides online help to guide you through the configuration process.

---

### Note

---

Do not move the slot location of the Access I/O transmitter module. Changing the location of this module may result in configuration problems.

---

Table 4-1 describes some of the basic SRM console commands used to verify system configurations on systems running the *Tru64 UNIX* operating system.

**Table 4-1: SRM Console Configuration Commands**

Command	Description
<code>show config</code>	Displays the buses on the system and the devices found on those buses.
<code>show device</code>	Displays the devices and controllers on the system.
<code>show memory</code>	Displays the main memory configuration.
<code>set and show</code>	Sets and displays the environment variables.

Refer to the *AlphaServer 1000A Rackmount Owner's Guide* for complete instructions on using the ECU and SRM console commands, or type `help` at the SRM prompt (>>>).

## 4.3 ISA Bus Expansion Chassis Configuration

The ISA bus expansion chassis provides a flexible capacity for adding voice modules of varying types based on products from Dialogic. See Section 1.4 for a complete list of available ISA bus expansion options.

Once the Dialogic voice modules are physically installed, you need to configure them by running the ECU from the IP Platform console terminal. Use the ECU to register the modules with the system hardware, and to reserve the addresses and interrupt request levels (IRQs) that are to be used by the modules. The ECU attempts to identify and resolve resource conflicts. The ECU may also be used to determine unused I/O ports, shared memory address, and IRQs.

In addition to the Dialogic voice modules, other components within the ISA bus expansion chassis include the:

- Fan
- Power supply
- Alarm sensor module
- Access I/O transceiver (AT bus expansion kit)

For a complete description of installing and configuring the voice-option modules, refer to the Dialogic documentation shipped with the option.

For a complete description of removing and replacing the fan or power supply, refer to the *I-Bus 4820 User Manual* that is shipped with your system.

Refer to Section 4.3.1 and Section 4.3.2 for complete descriptions of removing and replacing the alarm sensor module and the AT bus expansion kit.

### 4.3.1 Removing and Replacing the Alarm Sensor Module

The alarm sensor module is mounted in the drive bay area of the ISA bus expansion chassis. The 2T-IPSEN-AA alarm sensor module kit consists of an alarm sensor module, a cable to connect the alarm sensor module to the rear bulkhead, and a cable to connect the rear bulkhead to the alarm control module in the *AlphaServer 1000A*.

Perform the following procedure to remove the alarm sensor module:

1. Remove power from the ISA bus expansion chassis by pressing the On/Off switch on the front of the ISA bus expansion chassis.
2. Remove the screws that secure the ISA bus expansion chassis to the front rails and extend the ISA bus expansion chassis on the slides.
3. Remove the screws that secure the top cover and remove the top cover from the ISA bus expansion chassis.
4. Disconnect the 6-pin bulkhead cable, the 4-pin power supply cable, and the 2-pin temperature sensor cable from the alarm sensor module.
5. Remove the four screws that secure the alarm sensor module to the standoffs and remove the alarm sensor module.

To replace the alarm sensor module, reverse steps 1 through 5 of the removal procedure.

### 4.3.2 Removing and Replacing the AT Bus Expansion Kit

The 2T-VC220-IP AT bus expansion kit consists of the transmit module installed in the *AlphaServer* 1000A, the receive module installed in the ISA bus expansion chassis, and a 2-meter cable that connects the two modules.

Perform the following procedure to remove the receive module from the ISA bus expansion chassis:

1. Remove power from the ISA bus expansion chassis by pressing the On/Off switch on the front of the ISA bus expansion chassis.
2. Remove the screws that secure the ISA bus expansion chassis to the front rails and extend the ISA bus expansion chassis on the slides.
3. Remove the screws that secure the top cover and remove the top cover from the ISA bus expansion chassis.
4. Disconnect the cable from the receive module.
5. Remove the hold-down bar from across the top of the modules in the ISA bus expansion chassis.
6. Remove the screw that secures the receive module to the rear bulkhead of the ISA bus expansion chassis.
7. Remove the receive module from the ISA bus expansion chassis.

To replace the receive module in the ISA bus expansion chassis, reverse steps 1 through 7 of the removal procedure. Ensure that the jumpers on the new receive module are set to match the jumpers on the receive module being replaced.

### 4.4 Modular Storage Shelf BA35x-Sx Subsystem Configuration

The modular storage shelf BA35x-Sx contains the following components that may need to be removed and replaced:

- StorageWorks building blocks (SBBs)
- DWZZB-VW SCSI bus converter
- H885-AA tri-link connector block
- H879-AA SCSI terminator
- Disk drives
- Power supply

---

#### Important

---

Once a device has been initialized on a SCSI bus with a specific device address, moving the device to another bus or changing the device address can cause problems.

---

Refer to the *BA350 Modular Storage Shelf Subsystem User's Guide* for specific instructions on adding and removing StorageWorks components, and setting the correct device addresses.

## 4.5 Alarm Indicator Panel Configuration

The alarm indicator panel provides programmable visual and audible alarm indicators for the *AlphaServer IP Platform*. The alarm indicator panel consists of a metal frame, graphics panel(s), and alarm indicator module(s). A cable connects the alarm indicator module to the alarm control module that is installed on the *AlphaServer 1000A* PCI bus.

### 4.5.1 Removing and Replacing the Alarm Indicator Module

The alarm indicator module is mounted inside the alarm indicator panel.

Perform the following procedure to replace an alarm indicator module:

1. Power down the *AlphaServer 1000A* system.
2. At the front of the cabinet, remove the four screws that secure the alarm indicator panel frame to the front rails.
3. Disconnect the miniature 26-pin cable(s) from the connector(s) on the rear of the alarm indicator panel(s).
4. If attached, disconnect any cables connected to the dry contact terminal blocks.
5. On the rear of the alarm indicator panel that contains the alarm indicator module to be replaced, remove the two screws that secure the miniature 26-pin connector to the rear cover.
6. Remove the three screws from the top edge and the three screws from the bottom edge of the alarm indicator panel frame that secure the alarm indicator panel rear cover.
7. Remove the alarm indicator panel rear cover.
8. Remove the four screws that secure the alarm indicator module to the alarm indicator panel frame.

To replace the alarm indicator module, reverse steps 1 through 8 of the removal procedure.

---

#### Note

---

The alarm indicator panel should not be permanently removed without de-configuring it in the *Intelligent Peripheral Fault Manager (IPFM)* config file. Refer to the *Intelligent Peripheral Fault Manager for Tru64 UNIX Installation and User's Guide*.

---



---

# System Troubleshooting

## 5.1 Introduction

This chapter describes procedures for resolving problems with the components of the *AlphaServer Intelligent Peripheral (IP) Platform*. If the subsystem troubleshooting is discussed in another manual, a reference is provided to that documentation.

Before servicing the system, be aware of any service agreement that exists for your system. The agreement helps determine the level of maintenance for self-maintenance customers.

To correct a problem, locate the troubleshooting section for that component and refer to the appropriate documentation. If you cannot correct the problem, report it to your service representative.

---

### WARNING

---

**Only a qualified service person should install the system. A qualified service person is an individual who has the technical training and experience to be aware of the:**

- Hazards to which they are exposed in performing a task
- Measures to minimize the danger to themselves or other persons

**A qualified service person need not be a Compaq service representative.**

---

---

### VORSICHT

---

**Das System darf nur von qualifizierten Fachleuten installiert werden. Qualifizierte Fachleute sind Personen, die entsprechend technisch geschult sind und über die nötige Erfahrung verfügen, um:**

- die Gefahren zu erkennen, denen sie bei der Ausführung der Arbeit ausgesetzt sein könnten
- die notwendigen Maßnahmen zur Minimierung der Gefahr für sie selbst und für andere Personen zu ergreifen.

**Qualifizierte Fachleute sind nicht notwendigerweise Fachleute des Compaq-Kundendienstes.**

---

### 5.2 AlphaServer 1000A Subsystem

The *AlphaServer 1000A Rackmount Owner's Guide* provides the instructions on completing the following tasks or resolving these particular problems:

- Confirming that EISA modules or memory modules are properly configured
- Running a diagnostic test of the entire system, showing its status, or terminating the testing
- Checking the startup display when you turn on the system
- What to do if:
  - The power supply has shut down
  - Startup tests do not complete
  - The system cannot boot the operating system
  - The operating system reports errors, is hung, or crashes
  - The system cannot access a mass storage device
  - Storage devices are missing from the show device display
  - The system indicates network problems, an EISA module is not configured, or a PCI module is unseen by the system
  - The monitor or the terminal is not working
  - The keyboard and mouse are not working
  - The system repeatedly shuts down after 10 seconds
  - The system does not see or cannot access RAID drives
  - The Flash ROM is corrupted and the system cannot access console mode

### 5.3 Alarm Indicator Panel

The alarm indicator panel (see Figure 3-1) uses visual and audio alarm indicators to display the status of the IP Platform, including the ISA bus expansion chassis and the -48 Vdc power inverter or user alarm inputs. The alarm indicator panel displays alarms as long as it can communicate with the alarm control module in the *AlphaServer 1000A*, or until its backup batteries become fully discharged.

Refer to Section 3.3.1 for a description of the alarm indicator panel alarms and status displays. Refer to Section 3.3.1.1 for the procedure for replacing the batteries in the alarm indicator panel.



## 5.4 ISA Bus Expansion Chassis

The ISA bus expansion chassis contains alarm sensors that detect fault conditions and send the information to the alarm control module in the *AlphaServer 1000A* system chassis.

For a complete description of alarm sensor interaction with the IP Fault Manager software, see the *Intelligent Peripheral Fault Manager for Tru64 UNIX Installation and User's Guide*.

The status of the Dialogic voice modules is handled at the application level and not by the IP Fault Manager software.

## 5.5 Modular Storage Shelf BA35x-Sx Subsystem

The modular storage shelf BA35x-Sx uses the LEDs of its *StorageWorks* building blocks (SBBs) to indicate problems within the power unit, storage devices, and *StorageWorks* shelf. Depending upon the problem, these displays can be flashing, on, or off. The *BA350 Modular Storage Shelf Subsystem User's Guide* provides instructions on how to interpret these displays.

## 5.6 AlphaServer IP Power Controllers

If the power controllers do not function properly, perform the following steps:

1. Prior to turning on the circuit breakers for the 120 Vac or 250 Vac controllers, ensure that the neon indicator is on, indicating that an ac voltage is present. The -48 Vdc controller does not have an indicator for voltage. It should be connected to the -48 Vdc battery/power source prior to turning on the circuit breakers.
2. Check that the circuit breakers are on for each of the power controllers installed.
3. Refer to the *DIGITAL 2T-48VDC-xx -48Vdc-to-120Vac Power Inverter Owner's Guide* for more troubleshooting information on the -48 Vdc controller.



# A

---

## AlphaServer IP Platform Specifications

### A.1 Physical Dimensions

Table A-1 contains the physical dimensions for the *AlphaServer Intelligent Peripheral (IP) Platform*.

**Table A-1: Physical Dimensions**

Dimension	Specification
Depth	96.52 cm (38.0 in.) including doors
Width	55.88 cm (22.0 in.)
Height	220.01 cm (86.62 in.) including cable trough
Height	204.77 cm (80.62 in.) without cable trough
Weight	385.56 kg (850 lbs) for fully loaded duplex system
Front aisle	76.2 cm (30.0 in.) minimum clearance
Rear aisle	60.96 cm (24.0 in.) minimum clearance

### A.2 Electrical Specifications

Table A-2 contains the electrical specifications for each IP Platform power controller.

**Table A-2: Electrical Specifications for Each Power Controller**

Specification	Range
Input voltage	120 Vac or 250 Vac or -48 Vdc
Frequency (ac only)	50-60 Hz
Input current maximum	8.0 A at 120 Vac or 4.0 A at 250 Vac or 50 A at -48 Vdc

### A.3 System Environmental Specifications

Table A-3 contains the environmental specifications for the *AlphaServer IP Platform*.

**Table A-3: Environmental Specifications**

<b>Operating/Storage Conditions</b>	
Temperature range	10°C to 40°C (50°F to 104°F)
Barometric pressure	760 mm (29.92 in. Hg)
Relative humidity	20% to 80% (noncondensing)
Minimum dew point	2°C (36°F)
Maximum altitude	2,438 m (8,000 ft) <sup>1</sup>
Maximum wet bulb temperature	28°C (82°F)
<b>Nonoperating Conditions</b>	
Temperature range	-40°C to 66°C (-40°F to 151°F)
Relative humidity	20% to 85% (noncondensing)
Maximum altitude	4,877 m (16,000 ft) <sup>1</sup>

<sup>1</sup> The maximum allowable operating temperature above 2,438 m (8,000 ft) is reduced 1.8°C/1,000 m (1.0°F/1,000 ft).

## A.4 Dry Contact Specifications

Table A-4 contains the rating, input, and output specifications for the dry contact terminals.

**Table A-4: Dry Contact Specifications**

<b>Material and Ratings</b>	
Contact material	Gold-clad silver
Rating (resistive)	
Maximum switching power	60 W, 125 VA
Maximum switching voltage	220 Vdc, 250 Vac
Maximum switching current	2 A DC, 2 A AC
Maximum carrying current	3 A DC, 3 A AC
<b>Input Specifications</b>	
Type	Relay coil
Rated input voltage	5 Vdc nominal
Maximum input	10 Vdc at 50 C
Pick-up voltage	3.5 Vdc maximum
Drop-out voltage	0.5 Vdc minimum
Coil resistance	125 ohms, +/- 10%
<b>Output Specifications</b>	
Contact rating (switching)	
Voltage	220 Vdc, 250 Vac (maximum)
Current	2 A DC, 2 A AC (maximum)
UL/CSA	0.6 A, 125 Vac
	0.6 A, 110 Vdc
	2.0 A, 30 Vdc
Coil rating	200 mW typically

## A.5 Central Office Compatibility

The *AlphaServer IP Platform* is intended for deployment in telecommunications central office (CO) environments, and is compatible with some of Bellcore's Network Equipment-Building Systems (NEBS) specifications TR-NWT-000063.

Some of the central office compatible (conforming) hardware requirements supported by the *AlphaServer IP Platform* are:

- Simplex or duplex system housed within a single electronic equipment cabinet.
- Cabinet of welded steel construction has locking front and rear doors, bolt-down provisions at the cabinet base and top (for use only when a -48 Vdc power inverter is installed in the cabinet), four-wheel rugged castor base, four-point leveling, and cable egress from top or bottom of the cabinet.
- Integral cable trough attached to the top-rear half of the cabinet, and for larger systems, forms a continuous cable trough along the cabinet top-rear.
- 120 Vac, 250 Vac, and -48 Vdc dual-feed power models are available for the duplex system.
- Weight is 385.56 kg (850 lbs).

---

### Note

---

Floor loading is approximately 38.56 kg (85 lbs) per square foot according to NEBS weight calculation rules. Maximum allowed is 52.16 kg (115 lbs) per square foot.

---

- Operating relative humidity of 20% to 80%.
- Acoustic noise is less than 65 dBA.
- Designed to meet earthquake Zone 2.
- Meets FCC Class A specifications.
- Meets UL and other international safety specifications.

NEBS nonconforming features are:

- Cabinet depth is 96.52 cm (38 in.)
- Printer and terminal are table-top mounted.
- Fire testing not performed.
- Convenience outlets not provided.
- Earthquake testing for Zones 2, 3, and 4 not performed.

The *AlphaServer IP Platform* simplex and duplex systems are contained within one single bay 177.8 cm (70 in.) panel space cabinet (except for console terminal).

# B

## Alarm Input Wiring

### B.1 Alarm Input Wiring Diagram

The following diagram of the Intelligent Peripheral (IP) duplex platform displays the alarm input wiring connections between the ISA bus expansion chassis, the *AlphaServer 1000A* processors, and the alarm indicator panel.

Figure B-1: Alarm Input Wiring Diagram

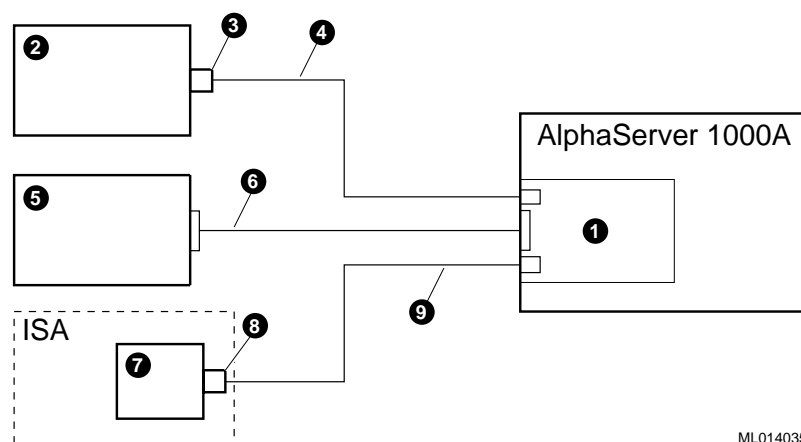

ML014035

- |   |   |
|---|---|
| ❶ Alarm control module installed in the <i>AlphaServer 1000A</i> system | ❸ D-sub 25-pin connector                |
| ❷ Alarm sensor module in the ISA bus expansion chassis                  | ❹ ISA bus expansion chassis alarm cable |
| ❸ D-sub 9-pin connector   |   |
| ❹ ISA bus expansion chassis alarm cable                                 |   |
| ❺ Alarm indicator panel   |   |
| ❻ Alarm indicator panel cable   |   |
| ❼ Inverter alarm cable  |   |

## B.2 Wiring User Alarm Inputs

This section provides information for wiring user TTL signal alarm inputs to the 8-pin MJ connector on the alarm control module installed in the *AlphaServer 1000A* system.

Figure B-2 shows the 8-pin MJ connector on the alarm control module that is used for connecting user alarm inputs.

**Figure B-2: Alarm Control Module 8-Pin MJ Connector**

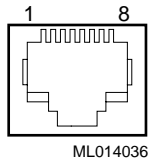

Table B-1 provides a pinout listing of the pins on the alarm control module 8-pin MJ connector. This table should be used to determine the correct wiring required for user alarm inputs.

**Table B-1: Alarm Control Module 8-Pin MJ Connector Pinout**

Pin No.	Signal
1	Inverter Fail or user input 1 Return
2	Inverter Fail or user input 1
3	Inverter Minor or user input 2 Return
4	Inverter Minor or user input 2
5	Inverter Major or user input 3 Return
6	Inverter Major or user input 3
7	Not used
8	Not used



---

## Field Wiring the -48 Vdc Power Inverter

### C.1 Field Wiring the -48 Vdc Power Controllers

The following sections describe how to field wire the -48 Vdc power controllers.

---

#### WARNING

---

The person(s) installing the system should be aware of the 1993 NEC (National Electrical Code) requirements for data processing equipment installation, Article 645, 645-2. Failure to follow these requirements could result in personal injury and damage to the equipment.

Only a qualified service person should install the system. A qualified service person is an individual who has the technical training and experience to be aware of the:

- Hazards to which they are exposed in performing a task
  - Measures to minimize the danger to themselves or other persons
- A qualified service person need not be a Compaq service representative.

---

#### VORSICHT

---

Die Personen, die das System installieren, sollten die Voraussetzungen des 1993 NEC (National Electrical Code) zur Installation von Datenverarbeitungsgeräten, Artikel 645, 645-2, kennen. Mißachtung dieser Voraussetzungen könnte zu Personen- und Geräteschaden führen.

Das System darf nur von qualifizierten Fachleuten installiert werden.

Qualifizierte Fachleute sind Personen, die entsprechend technisch geschult sind und über die nötige Erfahrung verfügen, um:

- die Gefahren zu erkennen, denen sie bei der Ausführung der Arbeit ausgesetzt sein könnten
- die notwendigen Maßnahmen zur Minimierung der Gefahr für sie selbst und für andere Personen zu ergreifen.

Qualifizierte Fachleute sind nicht notwendigerweise Fachleute des Compaq-Kundendienstes.

---

### C.1.1 Installing Suitable Field Wiring

The following subsections describe how to install suitable field wiring.

#### C.1.1.1 Field Wiring Recommendations

Table C-1 lists the field wiring recommendations for each side of the -48 Vdc power controller. The -48 Vdc power controller has dual power feeds.

**Table C-1: Field Wiring Recommendations for Each Power Feed**

Input Power Requirement	-48 Vdc Power Controller
Input voltage	-48 Vdc
Input current	50 A max
Inrush peak	6 A max soft start limited

**Recommended wire:** Wire should be U/L recognized and CSA certified for 105°C (221°F), with insulation rated for 600 Vac. Each of the 3-wire conductors should be a minimum of 6 AWG stranded.

---

**WARNING**

**High energy hazard. Proper precautions required.**

---

---

**VORSICHT**

**Hochspannungsgefahr. Geeignete Vorsichtsmaßnahmen sind notwendig.**

---

#### C.1.1.2 Installing the Wiring

1. Strip the wire insulation to approximately 1.27 cm (.50 in.).
2. Insert the wire into the terminal block as follows:
  - a. Observe the wire color/polarity
    - Black: -48 Vdc
    - White: +48 Vdc
    - Green/yellow: Ground
  - b. Torque the #10-32 compression screws to 40 to 45 inch-pounds.

---

**Note**

Refer to the *DIGITAL 2T-48VDC-xx -48Vdc-to-120Vac Power Inverter Owner's Guide* for information on powering up and testing the -48 Vdc inverter.

---

# D

---

## AlphaServer IP Platform Duplex System Diagrams

### D.1 Introduction

This appendix contains diagrams of the *AlphaServer Intelligent Peripheral (IP) Platform* duplex, ac and dc, systems.

## D.2 AlphaServer IP Platform Duplex AC System

This section contains the front, side, and rear views of the duplex ac system.

Figure D-1: IP Platform Duplex AC System Front and Side View

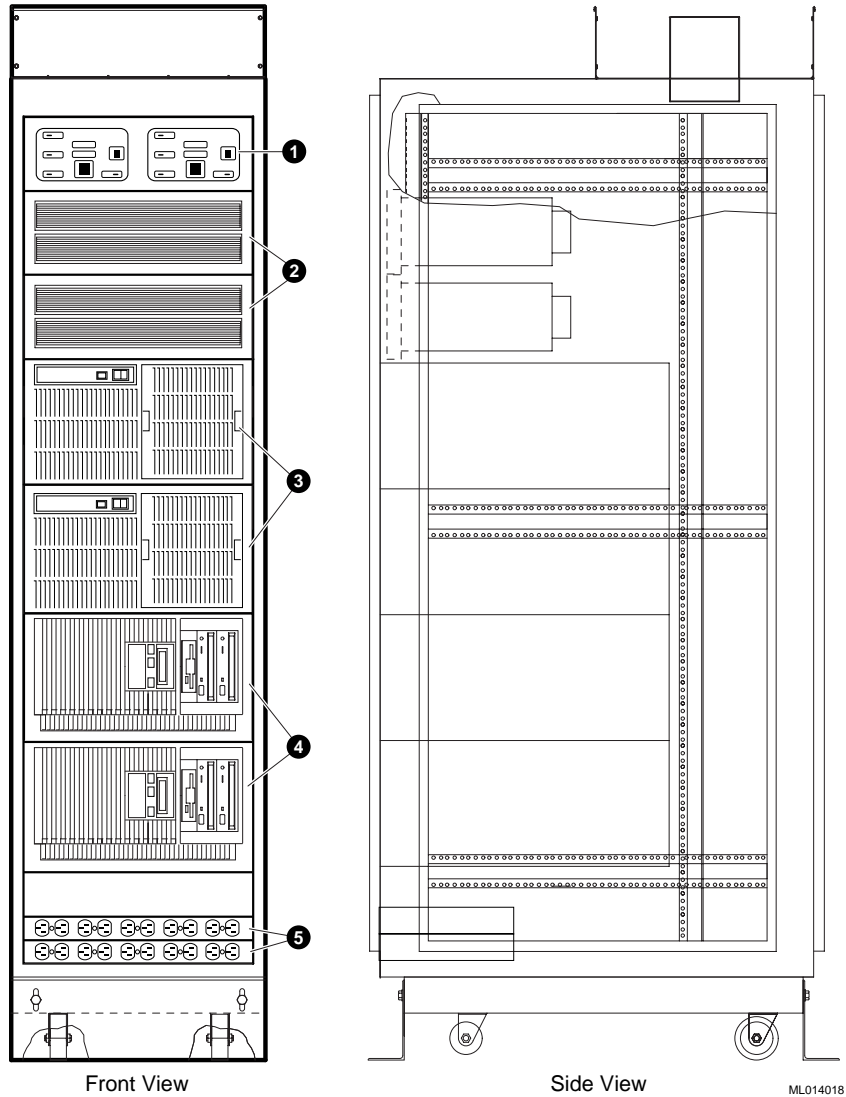

- ❶ Alarm indicator panels
- ❷ BA35x-Sx modular storage shelf (optional)
- ❸ ISA bus expansion chassis
- ❹ *AlphaServer 1000A*
- ❺ H7600 power controller

Figure D-2: IP Platform Duplex AC System Rear View

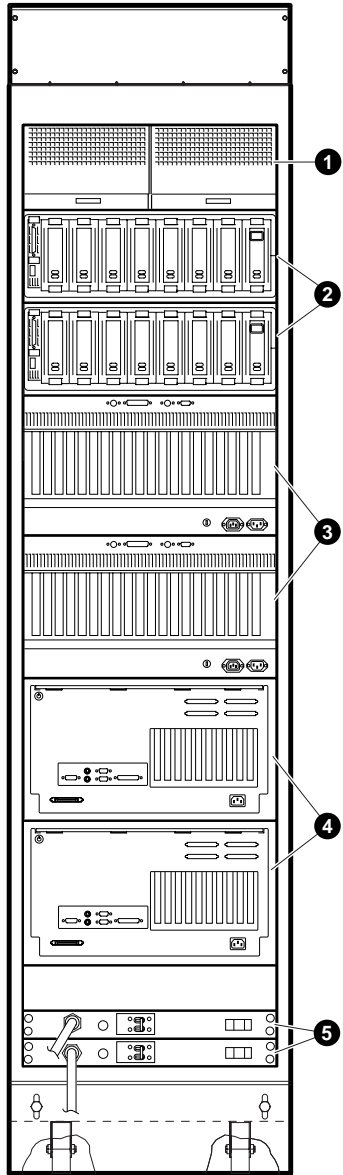

Back View

ML014028

- |   |                            |
|---|----------------------------|
| ❶ Alarm indicator panels                    | ❷ <i>AlphaServer</i> 1000A |
| ❸ BA35x-Sx modular storage shelf (optional) | ❹ H7600 power controller   |
| ❺ ISA bus expansion chassis                 |                            |

### D.3 AlphaServer IP Platform Duplex DC System

This section contains the front, side, and rear views of the duplex dc system.

Figure D-3: IP Platform Duplex DC System Front and Side View

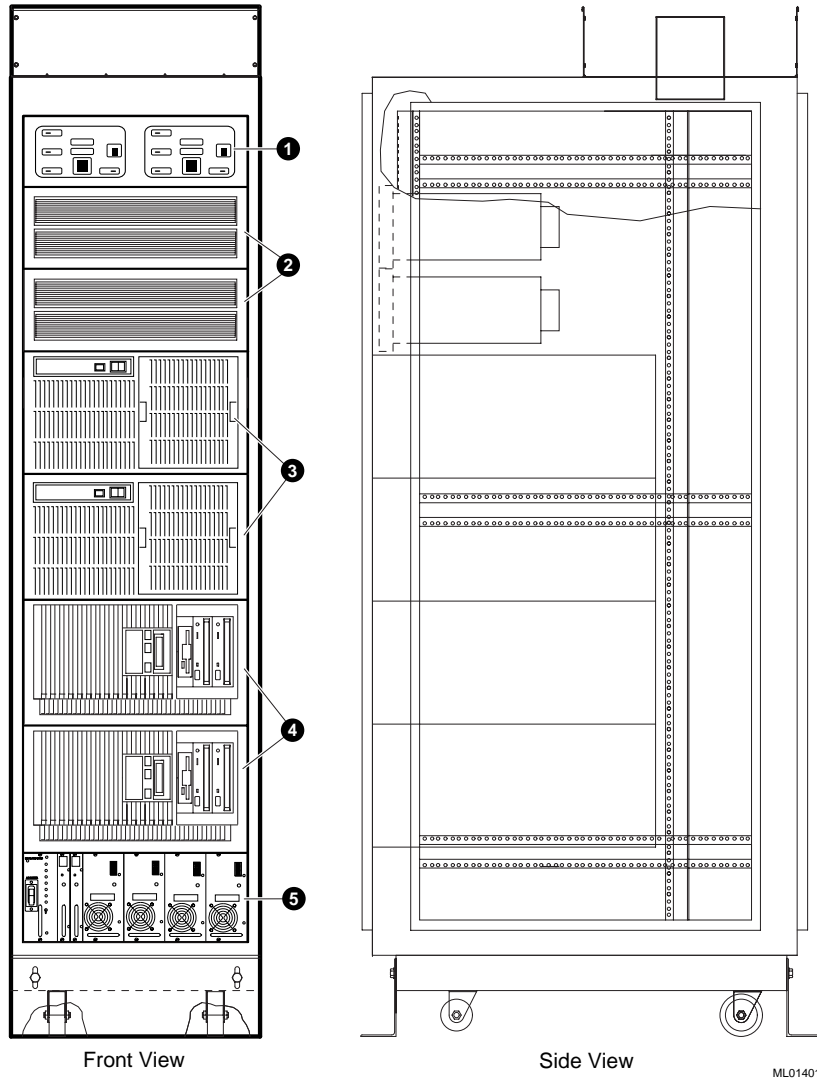

- ❶ Alarm indicator panels
- ❷ BA35x-Sx modular storage shelf (optional)
- ❸ ISA bus expansion chassis
- ❹ *AlphaServer* 1000A
- ❺ -48 Vdc power controller

Figure D-4: IP Platform Duplex DC System Rear View

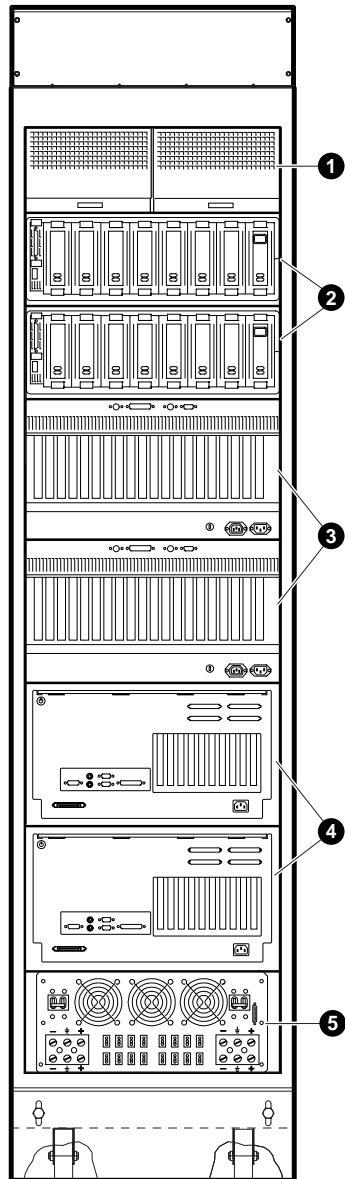

Back View

ML014027

- ❶ Alarm indicator panels
- ❷ BA35x-Sx modular storage shelf (optional)
- ❸ ISA bus expansion chassis
- ❹ *AlphaServer* 1000A
- ❺ -48 Vdc power controller





# E

---

## AlphaServer IP Platform Simplex System Diagrams

### E.1 Introduction

This appendix contains diagrams of the *AlphaServer Intelligent Peripheral (IP) Platform* simplex, ac and dc, systems.

## E.2 AlphaServer IP Platform Simplex AC System

This section contains the front, side, and rear views of the simplex ac system.

Figure E-1: IP Platform Simplex AC System Front and Side View

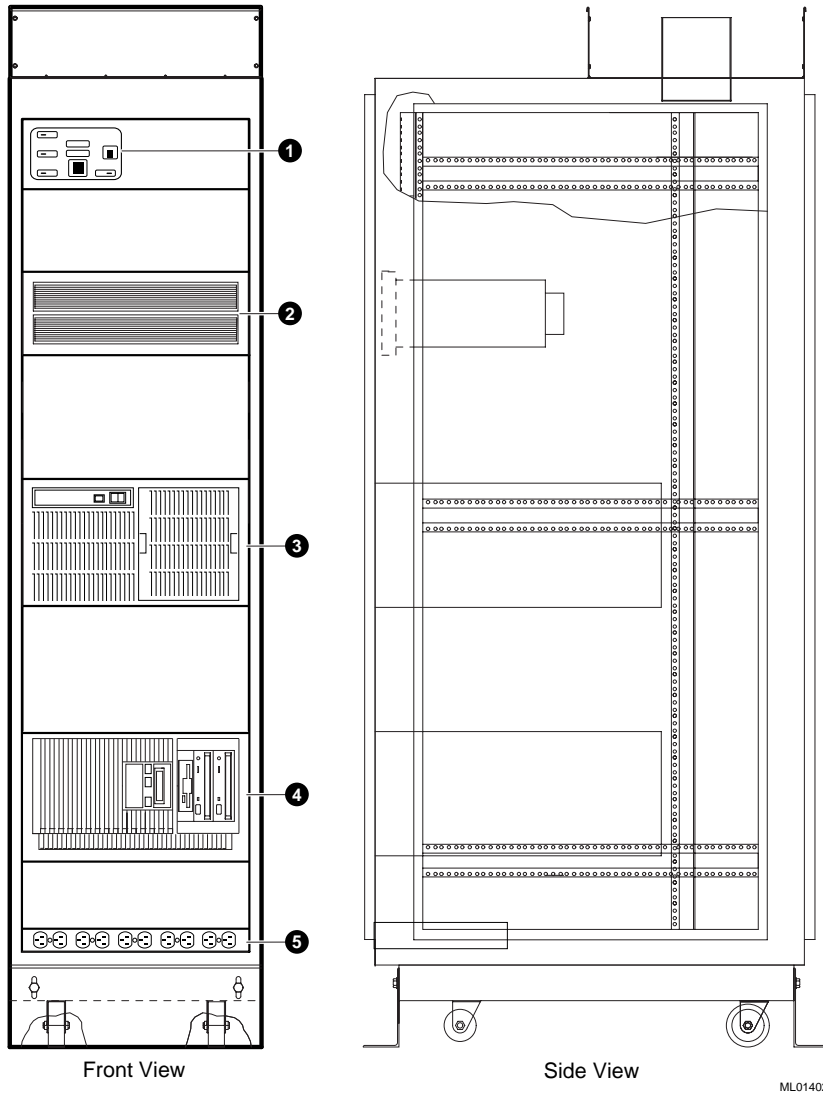

- ❶ Alarm indicator panel
- ❷ BA35x-Sx modular storage shelf (optional)
- ❸ ISA bus expansion chassis
- ❹ *AlphaServer 1000A*
- ❺ H7600 power controller

Figure E-2: IP Platform Simplex AC System Rear View

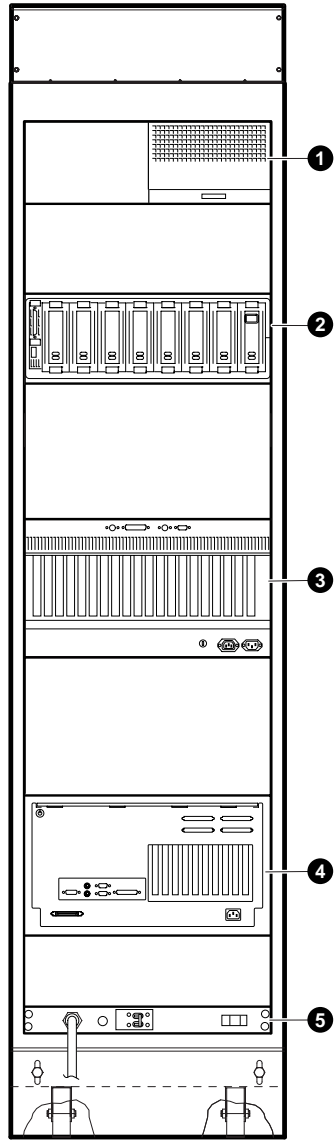

Back View

ML014032

- |   |                            |
|---|----------------------------|
| ❶ Alarm indicator panel                     | ❷ <i>AlphaServer</i> 1000A |
| ❸ BA35x-Sx modular storage shelf (optional) | ❹ H7600 power controller   |
| ❺ ISA bus expansion chassis                 |                            |

### E.3 AlphaServer IP Platform Simplex DC System

This section contains the front, side, and rear views of the simplex dc system.

Figure E-3: IP Platform Simplex DC System Front and Side View

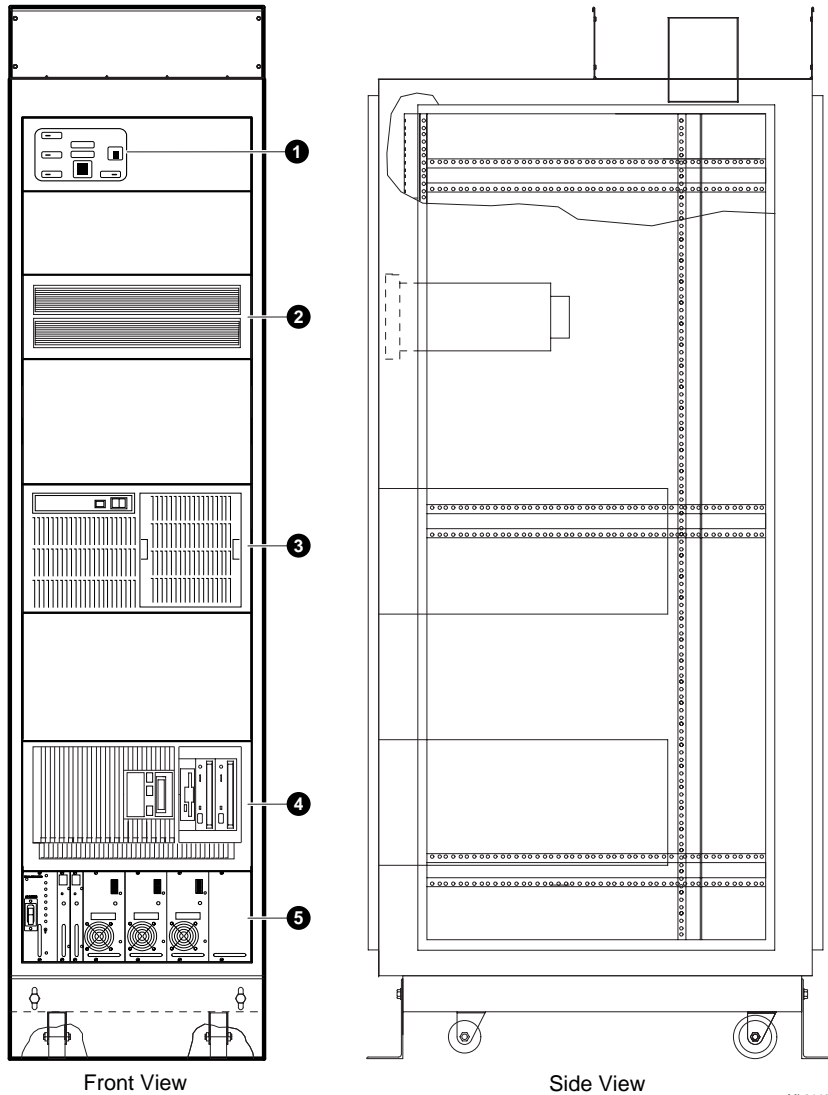

- ❶ Alarm indicator panel
- ❷ BA35x-Sx modular storage shelf (optional)
- ❸ ISA bus expansion chassis
- ❹ *AlphaServer 1000A*
- ❺ -48 Vdc power controller

Figure E-4: IP Platform Simplex DC System Rear View

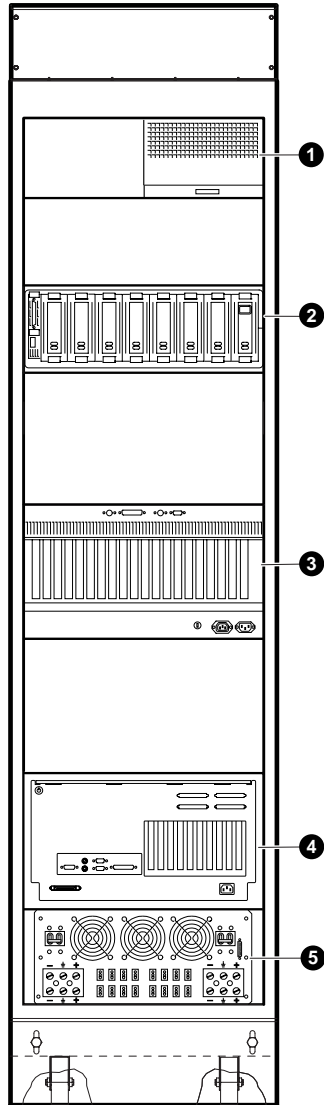

Back View

ML014031

- ❶ Alarm indicator panel
- ❷ BA35x-Sx modular storage shelf (optional)
- ❸ ISA bus expansion chassis
- ❹ *AlphaServer* 1000A
- ❺ -48 Vdc power controller



---

# Glossary

## **10Base-T Ethernet network**

The IEEE standard 802.3-compliant Ethernet products used for local distribution of data. These networking products characteristically use twisted-pair cable.

## **agent**

A background task running on the object being managed. The agent responds to requests for information by the network management station (NMS). The agent is responsible for performing get and set operations, for generating the appropriate traps, and for controlling access.

## **AlphaServer system**

Compaq's new generation of server systems based on the Alpha 64-bit computing architecture.

## **ARC**

Advanced RISC Computing (ARC) is the user interface to the console firmware for operating systems that expect firmware compliance with the Windows NT Portable Boot Loader Specification.

## **availability**

The amount of scheduled time that a computing system provides application service during the year. Availability is typically measured as a percentage of up time per year.

## **backbone**

A core network (usually high speed) to which multiple local area networks (LANs) are connected using bridges or routers and over which internetwork traffic can pass.

## **backplane**

The main module (board or panel) that connects all of the modules in a computer system.

## **boot**

Short for bootstrap. To load an operating system into memory.

## **boot device**

The device from which the system bootstrap software is acquired.

**bus**

A collection of many transmission lines or wires. The bus interconnects computer system components, providing a communications path for addresses, data, and control information or external terminals and systems in a communications network.

**cache**

A small, high-speed memory placed between slower main memory and the processor. A cache increases effective memory transfer rates and processor speed. It contains copies of data recently used by the processor and fetches several bytes of data from memory in anticipation that the processor will access the next sequential series of bytes.

**CD-ROM**

Compact disc read-only memory. The optical removable media used in a compact disc reader.

**central processing unit (CPU)**

The unit of the computer that is responsible for interpreting and executing instructions.

**command line interface**

One of two interfaces in the *AlphaServer* operator interface. The command line interface supports *OpenVMS* and *Tru64 UNIX* operating systems. It allows you to configure and boot the operating system.

**console mode**

The state in which the system and the console terminal operate under the control of the console program.

**console subsystem**

The subsystem that provides the user interface for a computer system when the operating system is not running.

**console terminal**

The terminal connected to the console subsystem. It is used to start the system and to direct activities between the user and the computer system.

**CSU**

Channel service unit. A device that terminates a digital channel on a customer's premises. It contains certain line conditioning and equalization functions, and responds to loopback commands sent from the central office.

**daughterboard**

A PC module that attaches to the component side of the host module.

**diagnostic program**

A program that finds and corrects problems with a computer system.



**dry contacts**

An electromagnetic device for remote or automatic control that is activated by variation in conditions of an electric circuit and that in turn operates other devices (such as switches) in the same or a different circuit.

**DSX-1**

Digital Signal Cross-connect Level 1. Any equipment that supports a set of parameters for cross-connecting DS-1 (either T-1 or E-1) lines.

**E-1**

Another name given to the CEPT (Conference of European Postal and Telecommunications Administrations) digital telephony format. E-1 is a digital transmission channel that carries data at the rate of 2.048 Mb/s (DS-1 level).

**ECC**

Error correction code. The code and algorithms used by logic to facilitate error detection and correction.

**EISA bus**

Extended Industry Standard Architecture bus. A 32-bit industry-standard I/O bus used primarily in high-end PCs and servers.

**EISA Configuration Utility (ECU)**

A feature of the EISA bus that helps you select a conflict-free system configuration and perform other system services. The ECU must be run whenever you change, add, or remove an EISA or ISA controller.

**environment variables**

The global data structures that can be accessed from console mode. The setting of these data structures determines how a system powers up, boots the operating system, and operates.

**Ethernet**

The IEEE 802.3 standard local area network.

**firmware**

The software code stored in hardware.

**initialization**

The sequence of steps that prepare the computer system to start. Initialization occurs after a system has been powered up.

**Interrupt request lines (IRQs)**

The bus signals that connect an EISA or ISA module (for example, a disk controller) to the system so that the module can get the system's attention by means of an interrupt.

**ISA**

Industry Standard Architecture. An 8-bit or 16-bit industry-standard I/O bus, widely used in personal computer products. The EISA bus is a superset of the ISA bus.

### **LAN**

Local area network. A high-speed network that supports computers connected over limited distances.

### **light-emitting diode (LED)**

An indicator of status on an IP subsystem.

### **MAC (media access control) address**

A unique 48-bit binary number (usually represented as a 12-digit hexadecimal number) encoded in a device's circuitry to identify it on a local area network.

### **Maintenance Operations Protocol (MOP) session**

A logical connection using the Maintenance Operations Protocol (MOP).

### **mass storage device**

An input/output device on which data is stored. Typical mass storage devices include disks, magnetic tapes, and CD-ROM.

### **module**

A hardware or software component that is a self-contained system interacting with a larger system. Hardware modules are often made to plug into a main system.

### **network**

A collection of computers, terminals, and other devices together with the hardware and software that enables them to exchange data and share resources over either short or long distances.

### **network management station (NMS)**

A PC or workstation equipped with an Ethernet, FDDI, or Token Ring network module and *HUBwatch* software that enables it to communicate with and manage network modules.

### **network modules**

Modular devices that provide network connectivity or services that can be installed in a *DEChub* backplane or used as standalone devices. Network modules include repeaters, concentrators, bridges, routers, access servers, switches, and SNMP agents.

### **PCI**

Peripheral component interconnect. An industry-standard expansion I/O bus that is the preferred bus for high-performance I/O options. PCI is available in a 32-bit version and a 64-bit version.

### **PCI-to-EISA bridge**

The capability to transfer commonly available EISA and ISA options to the PCI bus.

### **protocol**

A formal set of rules governing the format, timing, sequencing, and error control of exchanged messages on a data network.

**RAID**

Redundant arrays of independent disks. A technique that organizes disk data to improve performance and reliability. RAID has three attributes: it is a set of physical disks viewed by the user as a single logical device; the user's data is distributed across the physical set of drives in a defined manner; and redundant disk capacity is added so that the user's data can be recovered even if a drive fails.

**redundant**

Pertaining to duplicate or extra computing components that protect a computing system from failure.

**reliability**

The probability that a device or system will not fail to perform its intended functions during a specified time.

**repeater**

A level 1 hardware device that restores signal amplitude, waveform, and timing of signals before transmission to another network segment.

**SBB**

*StorageWorks* building block. The basic building block of the *StorageWorks* product line. Any device conforming to shelf mechanical and electrical standards installed in either a 3½-inch or 5¼-inch carrier is considered to be an SBB, whether it be a storage device, a power supply, or other device.

**SCSI**

Small Computer Systems Interface. An ANSI-standard interface for connecting disks and other peripheral devices to computer systems. Some devices are supported under the SCSI-1 specification; others are supported under the SCSI-2 specification.

**server**

A network node or specialized device that provides and manages access to shared network resources, such as hard disks, printers, and software.

**SIMM**

Single in-line memory module. A plug-in module that has RAM chips on one side, and an edge connector that matches a socket on the system module.

**Simple Network Management Protocol (SNMP)**

A high-level, standards-based protocol for network management, usually used in TCP/IP (Transmission Control Protocol/Internet Protocol) networks.

**SNMP agent**

An entity in a hardware device that executes SNMP requests.

**SRM**

The user interface to console firmware for operating systems that expect firmware compliance with the Alpha System Reference Manual (SRM).

### **StorageWorks**

Compaq's modular storage subsystem (MSS), which is the core technology of the Alpha SCSI-2 mass storage solution. *StorageWorks* consists of a family of low-cost mass storage products that can be configured to meet current and future storage needs.

### **system disk**

The device on which the operating system resides.

### **T-1**

The digital telephony format used in North America. T-1 is a digital transmission link handling 24 voice conversations on two pairs of twisted wires.

### **Telnet**

The TCP/IP standard protocol for remote terminal connections. Using Telnet, a user at one site can connect to a timesharing system at another site as if the user's terminal is connected directly to the remote machine.

### **terminal server**

A module that allows a terminal to connect to a network node.

### **ThinWire**

Ethernet cabling and technology used for local distribution of data communications. ThinWire cabling is thinner than thick wire cabling.

### **Transmission Control Protocol (TCP)**

The transport protocol offering a connection-oriented transport service in the Internet suite of protocols.

### **workgroup**

A configuration that consists of a relatively small number of devices attached to a LAN that is isolated from the extended LAN backbone by a bridge or router.

---

# Index

## A

---

- Alarm indicator module
  - replacing, 4–5
- Alarm indicator panel
  - diagram, 3–3
  - replacing batteries, 3–4
  - troubleshooting, 5–2
- Alarm input wiring diagram, B–1
- Alarm sensor module
  - replacing, 4–3
- Alarm subsystem, 1–4
- AlphaServer* 1000A system
  - components, 4–2
  - optional hardware, 1–7
  - overview, 1–6
  - power-up, 3–1
  - reconfiguring, 4–2
  - required hardware, 1–7
  - troubleshooting, 5–2
- AT bus expansion kit
  - replacing, 4–4

## B

---

- BA35x-Sx. *See* Modular storage shelf

## D

---

- Dialogic modules, 1–9
- Dry contact specifications, A–3
- Dry contacts, 3–5
- Duplex system. *See* IP Platform
  - ac system diagrams, D–2
  - dc system diagrams, D–4
  - duplex system, 1–2

## E

---

- E-1
  - 120-ohm network connections, 2–6
  - 120-ohm pin designations, 2–6

- 75-ohm network connections, 2–6
- 75-ohm pin designations, 2–6
- EISA Configuration Utility (ECU), 4–2
- Electrical specifications, A–1
- Environmental specifications, A–2
- External hardware options, 1–11

## F

---

- Factory installed
  - hardware, 2–1
  - software, 1–3
- Fault management, 1–3
- Features
  - alarm subsystem, 1–4
  - corporation and industry standards, 1–5
  - maintainability, 1–4
  - reliability, 1–4
  - system security, 1–6
  - upgrading, 1–5
  - user interfaces, 1–4

## H

---

- Hardware
  - factory installed, 2–1
- Hardware setup, 2–3
  - connecting network hardware, 2–4
  - installing the platform, 2–4

## I

---

- Installation
  - hardware installation, 2–3
  - preinstallation considerations, 2–2
  - site preparation, 2–2
- Intelligent Peripheral Platform. *See* IP Platform
- Interfaces
  - telecommunications, 1–5
  - user, 1–4

## Index

### IP Platform

- duplex ac system diagrams, D-2
- duplex dc system diagrams, D-4
- duplex system, 1-2
- electrical specifications, A-1
- environmental specifications, A-2
- installing, 2-4
- overview, 1-1
- physical dimensions, A-1
- power controller, 2-8
- power-up, 3-1
- reconfiguration, 4-1
- simplex ac system diagrams, E-2
- simplex dc system diagrams, E-4
- simplex system, 1-2
- troubleshooting, 5-1

### ISA bus expansion chassis

- components, 4-3
- hardware, 1-9
- overview, 1-8
- reconfiguring, 4-3
- troubleshooting, 5-3

## L

---

### Loop-start network

- 25-pin designations, 2-7
- 50-pin designations, 2-8
- hardware connections, 2-7

## M

---

### Modular storage shelf

- components, 4-4
- hardware, 1-8
- operation, 3-7
- overview, 1-8
- reconfiguring, 4-4
- status LEDs, 3-7
- troubleshooting, 5-3

## N

---

NEBS compatibility, A-4

## P

---

Physical dimensions, A-1

### Power controller subsystem

- dc field wiring, C-1
- hardware, 1-10
- overview, 1-10
- troubleshooting, 5-3

## R

---

Replacing alarm indicator module, 4-5

Replacing alarm indicator panel batteries, 3-4

Replacing alarm sensor module, 4-3

Replacing AT bus expansion kit, 4-4

## S

---

Simplex system. *See* IP Platform

ac system diagrams, E-2

dc system diagrams, E-4

simplex system, 1-2

Site preparation, 2-2

Software

factory installed, 1-3

SRM console commands, 4-2

Standards

electromagnetic, 1-5

safety, 1-5

telecommunications, 1-5

StorageWorks. *See* Modular storage shelf

System security, 1-6

## T

---

T-1

cable length, 2-2

network connections, 2-5

pin designations, 2-5

Telecommunications interfaces, 1-5

Troubleshooting

alarm indicator panel, 5-2

*AlphaServer* 1000A, 5-2

IP platform, 5-1

ISA bus expansion chassis, 5-3

modular storage shelf, 5-3

power controller

subsystem, 5-3

## U

---

User alarm input wiring, B-2

User interfaces, 1-4