



ATMworks 350L Adapter Installation Guide

Part No. EK-DGLPL-IN, Rev A02

Digital Equipment Corporation makes no representations that the use of its products in the manner described in this document will not infringe on existing or future patent rights, nor do the descriptions contained in this document imply the granting of licenses to make, use, or sell equipment or software in accordance with the description.

Restricted Rights: Use, duplication, or disclosure by the U.S. Government is subject to restrictions as set forth in subparagraph (c)(1)(ii) of DRARS252.227-7013, or in FAR 52.227.19 or in FAR 52.227-Alt.III, as applicable.

© Digital Equipment Corporation 1996. All rights reserved.

The following are trademarks of Digital Equipment Corporation: DEC, Digital, ATMworks, and DIGITAL logo.

Federal Communications Commission (FCC) Statements

Multi-mode Fiber Adapters:

This equipment has been tested and found to comply with the limits for a Class B digital device, pursuant to Part 15 of the FCC Rules. These limits are designed to provide reasonable protection against harmful interference in a residential installation. This equipment generates, uses and can radiate radio frequency energy and, if not installed and used in accordance with the instruction, may cause harmful interference to radio communications. However, there is no guarantee that interference will not occur in a particular installation. If this equipment does cause harmful interference to radio or television reception, which can be determined by turning the equipment off and on, the user is encouraged to try to correct the interference by one or more of the following measures:

- Reorient or relocate the receiving antenna.
- Increase the separation between the equipment and the receiver.
- Connect the equipment into an outlet on a circuit different from that to which the receiver is connected.
- Consult the dealer or an experienced radio/TV technician for help.

Modifications:

Changes or modifications not expressly approved by Digital Equipment Corporation could void the user's authority to operate this equipment.

Canadian RF Interference Statement

This digital apparatus does not exceed the Class B limits for radio noise emissions from digital apparatus as set out in the radio interference regulations of the Canadian Department of Communication.

Le Présent appareil numérique n'émet pas de bruits radioélectriques dépassant les limites applicables aux appareils numériques de Class B prescrites dans le règlement sur le bronillage radioélectrique édicté par le Ministère des Communications du Canada.

Japanese RF Interference Statement: VCCI, Class 2

この装置は、第二種情報装置（住宅地域又はその隣接した地域において使用されるべき情報装置）で住宅地域での電波障害防止を目的とした情報処理装置等電波障害自主規制協議会（VCCI）基準に適合しております。
しかし、本装置をラジオ、テレビジョン受信機に近接してご使用になると、受信障害の原因となることがあります。
取扱説明書に従って正しい取り扱いをして下さい。

PCI Category 5 UTP Adapters:**FCC ID: MSI155P-U5**

This device complies with Part 15 of the FCC Rules. Operation is subject to the following two conditions: (1) this device may not cause harmful interference, and (2) this device must accept any interference received, including interference that may cause undesigned operation.

Radio Frequency Interference Statement

Note: this equipment has been tested and found to comply with the limits for a Class B digital device, pursuant to Part 15 of the FCC Rules. This equipment generates, uses and can radiate radio frequency energy. If not installed and used in accordance with the instructions, it may cause interferences to radio communications.

The limits are designed to provide reasonable protection against such interference in a residential situation. However, there is no guarantee that interference will not occur in a particular installation. If this equipment does cause harmful interference to radio or television reception, which can be determined by turning the equipment on and off, the user is encouraged to try to correct the interference by one or more of the following measures:

- Reorient or relocate the receiving antenna of the affected radio or television.
- Increase the separation between the equipment and the affected receiver.
- Connect the equipment and the affected receiver to power outlets on separate circuits.
- Consult the dealer or an experienced radio/TV technician for help.

Modifications:

Changes or modifications not expressly approved by Digital Equipment Corporation could void the user's authority to operate this equipment.

Canadian RF Interference Statement

This digital apparatus does not exceed the Class B limits for radio noise emissions from digital apparatus as set out in the radio interference regulations of the Canadian Department of Communication.

Le Présent appareil numérique n'émet pas de bruits radioélectriques dépassant les limites applicables aux appareils numériques de Class B prescrites dans le règlement sur le bruissement radioélectrique édicté par le Ministère des Communications du Canada.

Japanese RF Interference Statement: VCCI, Class 2

この装置は、第二種情報装置（住宅地域又はその隣接した地域において使用されべき情報装置）で住宅地域での電波障害防止を目的とした情報処理装置等電波障害自主規制協議会（VCCI）基準に適合しております。

しかし、本装置をラジオ、テレビジョン受信機に近接してご使用になると、受信障害の原因となることがあります。

取扱説明書に従って正しい取り扱いをして下さい。

1 Introduction

- About This Guide, 9
 - Related Documents, 9
- Product Overview, 10
 - ATMworks 350L LEDs, 11
 - Unpacking and Inspection, 11
- ATM Concepts, 12
 - ATMworks 350L IP Addresses, 12
 - Use of the Subnet Mask, 13
 - LAN Emulation through ATM, 14
 - LAN Emulation Components, 15
 - The LAN Emulation Client, 16
 - LAN Emulation Configuration Server, 16
 - The LAN Emulation Server, 16
 - Broadcast Unknown Server, 16

2 ATMworks 350L Hardware Installation

- Installation Procedure, 19
- Initial Hardware Verification Procedures, 21
- Attaching Cables to the ATMworks 350L, 25
- ATMworks 350L Specifications, 27

3 Software Installation and Configuration

- Installation Requirements, 29
- Configuration Parameters, 30
 - Configuring the Port Interface, 30
 - Slot Number, 30
 - UNI Version, 30
 - Cell Frame Type, 30

- Empty Cell Type, 30
- Configuring the LANE Clients, 31
 - Using the ESI as the MAC Address, 31
 - Bypassing the LECS, 32
 - Using the “well-known” LECS Address, 32
 - Setting an ELAN Name, 32
- Software Installation Procedure, 33
 - Removing the Software, 42
 - Moving the ATMworks 350L, 42
 - Updating the Software, 43
- Verifying Operations, 44

Appendix A Event Viewer Messages

- Event Categories, 47
 - ILMI messages, 47
 - QSAAL Messages, 48
 - Q93B Messages, 49
 - LEC Messages, 50
 - AAL Messages, 58



Figures

- Figure 1-1** Relationship of IP Address to Subnet Mask, 14
- Figure 1-2** Defining a Subnet using Subnet Mask, 14
- Figure 1-3** Network Protocol Interfaces, 15
- Figure 2-1** Diagnostics Command Line “help” Listing, 22
- Figure 2-2** Dust Protecting Cap, 25
- Figure 2-3** RJ45 Pinout for Category 5 UTP, 26

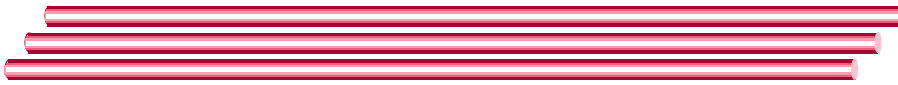

Tables

- Table 2-1** ATMworks 350L MMF Technical Specifications, 27
- Table 2-2** ATMworks 350L Cat 5 Technical Specifications, 28
- Table 3-1** Event Log Messages Under Normal Conditions, 45

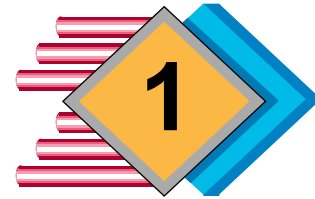

Introduction

About This Guide

This manual describes the installation and configuration of an ATMworks 350L in any PC with an Intel 486 or greater (Pentium) processor running Windows NT 3.51 or greater. This guide includes procedures for running hardware diagnostics and for installing the ATMworks 350L driver software.

Related Documents

For more information on ATM and related subjects, refer to the following documents:

- ❖ “TCP/IP Network Administration”; O’Reilly & Associates, Inc.; March 1993, ISBN 0-937175-82-X
- ❖ “ATM Forum User-Network Interface Specification”, v 3.0, ISBN 0-13-225863-3
- ❖ “ATM Forum LAN Emulation Over ATM Specification” - Version 1.0, LAN Emulation SWG Drafting Group
- ❖ ITU-TS draft Recommendation Q.93B “B-ISDN User-Network Interface Layer 3 Specification for Basic Call/Bearer Control”, May 1993

Product Overview

All ATMworks 350L adapters are single-slot and provide a high performance architecture using a custom Application Specific Integrated Circuit (ASIC) chip. This chip implements the ATM Adaptation Layer 5 (AAL5) protocol to map protocol Data Units (PDUs) into the information field of ATM cells and vice versa. The ATMworks 350L supports the following features:

- ❖ High performance 155.52 Mbps ATM connectivity
- ❖ AAL5 and raw ATM traffic support
- ❖ Per VC rate control
- ❖ Early packet discard
- ❖ Integrated segmentation and reassembly (SAR)
- ❖ High performance convergence sublayer support
- ❖ Extensive variable bit rate (VBR) capabilities
- ❖ SONET/SDH (STS-3c/STM-1) physical layer support
- ❖ Fiber optics and unshielded twisted pair support
- ❖ Operation and Maintenance (OAM) cell support

At the core of the hardware is a custom-designed segmentation and reassembly (SAR) ASIC. This ASIC enhances performance by providing a hardware solution for the more complex functions of the ATM protocol. Functions such as the SAR and the common part convergence sublayer (CPCS) of AAL5 are implemented in the ASIC.

Each virtual connection (VC) can be configured as an AAL5 connection or can be configured to transmit and receive raw data traffic. Raw data traffic consists of user-defined cell formats, as opposed to those formatted by the ASIC to conform to the AAL5 layer.

The ASIC also includes a high performance Direct Memory Access (DMA) engine and slave copy capabilities. By designing a DMA engine specific to the ATM environment, Digital Equipment Corporation is providing the network with maximum throughput by avoiding some of the limitations of the I/O architecture (i.e., the host bus).

ATMworks 350L LEDs

The port on each ATMworks 350L is equipped with an LED that indicates proper cable connection. This LED, marked with a "#", is helpful when connecting cabling because it indicates when the cables have been hooked up correctly.

The LED is lit when a valid SONET/SDH format signal is being received; it remains unlit if connected to a non-SONET/SDH format signal.



Note: *The LED will be lit when the ATMworks 350L is in diagnostic loopback mode regardless of what is connected to it.*

Unpacking and Inspection

Each ATMworks 350L should arrive in good condition. Before unpacking the card and accessories, check for any obvious damage to the packaging and notify your carrier immediately upon receipt.

The following items are included with each ATMworks 350L:

- ❖ Media containing driver software and configuration files
- ❖ This ATMworks 350L installation and configuration manual
- ❖ Anti-static wrist strap



Inspecting the ATMworks 350L

- 1 Attach the provided wrist strap as shown in the figure on the wrist strap envelope.
- 2 Remove the ATMworks 350L card from the antistatic bag and check for any damage.
- 3 If there are any visible signs of damage, return the card to the antistatic bag and repackage it in the original shipping container.
- 4 If any item is missing or damaged, immediately contact a Digital Authorized VAR or distributor, or Digital Customer Service.

ATM Concepts

The ATMworks 350L driver software is easy to install, yet there are certain pieces of information you will need to enter during the procedure. This section aims to provide the background needed to help you make decisions about how to configure your ATMworks 350L.

Asynchronous Transfer Mode networking technology represents a completely different paradigm than that used in existing LANs today. The Ethernet, Token Ring, and FDDI networks that are in widespread use are designed to broadcast data to all nodes. These networks use TCP/IP and other protocols to transfer the data.

By contrast, ATM transfers data over specific Virtual Channel Connections (VCCs) that are created between one node and the next. ATM networks also require switches to route the data from one VCC to another.

Permanent Virtual Channels (PVCs) can be created and removed manually by a network administrator. This takes quite a bit of time and coordination to create a channel between each of the nodes on the network through one or more switches. Switched Virtual Channels (SVCs) are created dynamically using signalling protocols. The end-stations and switches exchange signals to set up and take down the SVCs as necessary. The Digital Equipment Corporation ATMworks 350L software is designed to create dynamic SVCs for data transfer; PVCs are not currently supported.

Though the high-speed data transfer rates of ATM are in high demand, some users would like to see ATM operate like the Ethernet network with which they are already familiar. For this reason, the ATMworks 350L software provides a LAN Emulation Client (LEC) so that an end-station can be configured to operate like any other node on an Ethernet LAN. This and other concepts are described in the following sections.

ATMworks 350L IP Addresses

In order for your ATMworks 350L to communicate with other devices using the TCP/IP protocol, it must be assigned an IP address.

Your site may have been assigned a set of IP addresses by the Internet Authority Board (IAB). The IAB ensures that each site with Internet access has a unique set of IP addresses that it can assign to its network nodes. You may have a block of addresses that you can use, or a single Class A or Class B address that you can “subnet” using a subnet mask (described in the next section).



CAUTION: *The IP addresses for your ATMworks 350L must be on a separate subnetwork from any Ethernet, Token Ring or FDDI network you have currently configured at your site.*

Use of the Subnet Mask

Along with the IP address, a “subnet mask” must be defined for the ATM network. The subnet mask (also called the IP netmask) is used to specify the part of an IP address that designates the network and the part that designates the nodes or hosts on the network.

The subnet mask is used by routers, bridges, and other devices on the network in routing packets. The network part of the IP address tells the device whether the destination for the packet is on its same network. Once the correct network for the packet is found, the host portion is used to determine the packet’s destination (or source).

Each non-zero bit in the subnet mask indicates that the corresponding bit of the IP address is part of the network designator. Each bit set to zero indicates that the corresponding bit of the IP address designates a network node.

In the example shown in Figure 1-1, the subnet mask is shown in dotted-decimal notation. The first three octets are set to “255” (all ones). The same subnet mask is shown in binary in Figure 1-2.

Figure 1-1 Relationship of IP Address to Subnet Mask

This subnet mask provides addresses for up to 256 nodes on the 194.86.24 network. To have more networks and fewer nodes on each network, set some of the bits in the last octet of the subnet mask to 1. The bits set to 1 will designate networks.

	Network			Node
Subnet Mask:	255	.255	.255	.0
IP Address:	194	.86	.24	.10

When this subnet mask is applied to an IP address, it indicates that the first three octets of the IP address identify the network. Likewise, the final octet of the subnet mask is zero, indicating that the last octet of the IP address identifies nodes on the network.

Figure 1-2 Defining a Subnet using Subnet Mask

Here, only the last four bits of the last octet are used to number the nodes on the network. Using just the last four bits only allows 16 nodes per network. However, the first four bits of the octet allow the designation of 16 more subnetworks than were available before.

	Network				Node
Subnet Mask:	255	.255	.255	.240	
Binary:	1111 1111	1111 1111	1111 1111	1111 0000	

LAN Emulation through ATM

LAN Emulation enables Ethernet or Token Ring traffic to run over ATM media without modification of existing applications. The LAN Emulation function operates at the media access control (MAC) sublayer of the OSI model's Data Link Layer. LANE protocols are used instead of MAC layer protocols to provide a service interface for the network layer protocols, as shown in Figure 1-3.

Figure 1-3 Network Protocol Interfaces

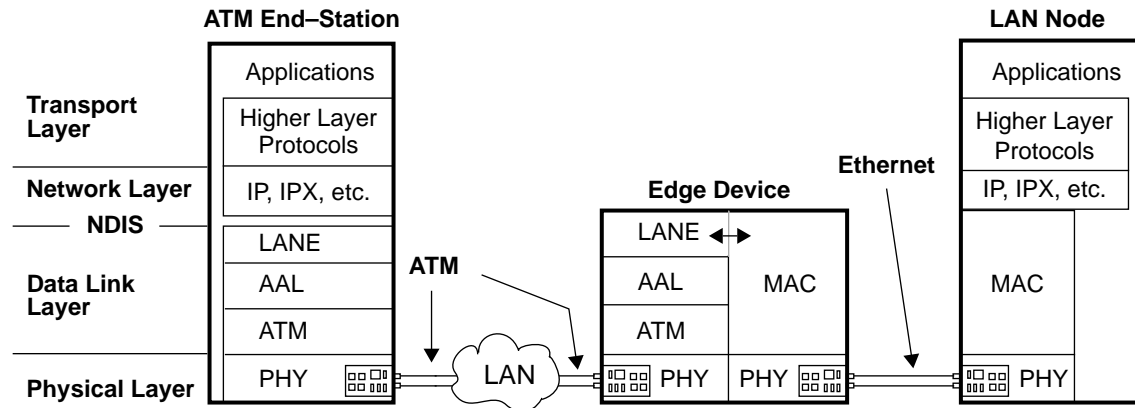

Data sent across the ATM network is encapsulated into the appropriate LAN MAC packet format. Thus, the LANE protocols allow an ATM network operate like an Ethernet LAN, only faster.

The driver software for the ATMworks 350L you have purchased allows your PC to be configured to operate as a “client” on an emulated LAN. The client software interfaces the ATM network to the higher-level (network layer) protocols so that they continue to communicate as though on an Ethernet LAN.

LAN Emulation Components

Each individual emulated LAN will consist of the following components:

- ❖ A set of LAN Emulation Clients (LECs)
- ❖ One LAN Emulation Service consisting of:
 - one LE Configuration Server (LECS) (optional)
 - one LE Server (LES)
 - a Broadcast Unknown Server (BUS)

The LAN Emulation Client

An LEC is part of an ATM end-station that provides a standard LAN service interface to any higher layer entity. The LEC also performs data forwarding, address resolution, and other functions within a single ELAN. Each LEC subnet can only reside on one emulated LAN at a time.

Each LEC has its own ATM address and/or ELAN name that may be used by the LANE Server in assigning the LEC membership in an ELAN. The administrator can assign an LEC to a particular ELAN using the ATMworks 350L's software configuration tools.

LAN Emulation Configuration Server

The LECS controls the assignment of LANE Clients to ELANs by directing them to the LES that corresponds to the designated ELAN. There is only one LECS per administrative domain serving all ELANs in that domain. The LECS has a unique ATM address.

The LAN Emulation Server

The LES coordinates control of the emulated LAN. The LES provides a facility for registering and resolving MAC addresses and/or 802.5 route descriptors to ATM addresses.

The LEC can register MAC addresses with the LES and query the LES to resolve MAC addresses and/or route descriptors. The LES may either answer a query directly or forward the query to other LECs so they may respond.

There is only one LES per ELAN and it has a unique ATM address.

Broadcast Unknown Server

The BUS provides the same type of broadcast and multicast service that is found in shared media LANs such as Ethernet. The BUS is basically a multicast server that forwards unknown destination traffic, broadcast traffic, and multicast traffic to all clients on a particular ELAN.

The LANE 1.0 specification defines only one BUS per ELAN. The BUS also has a unique ATM address that is configured

in the LES to map it to the broadcast MAC address (all ones). Also, the LES and BUS may have the same address.

Now you are ready to execute the installation and configuration procedures described in the next chapter. If any problems occur or you have any questions, please contact a Digital Authorized VAR or distributor, or Digital Customer Service.



ATMworks 350L Hardware Installation

Installation Procedure

This chapter provides information on installing a single ATMworks 350L in a system with an Intel x86 processor running Windows NT. Each computer system will have its own particular hardware configuration for installing network interface expansion cards. Refer to the detailed hardware installation procedures for your particular computer system.



CAUTION: *To avoid possible damage to components of the ATMworks 350L card or your system, use the anti-static grounding wrist strap when handling the card.*



To install the ATMworks 350L on your computer

- 1 Shut down the system and power it off, but do not unplug the system from the power source.
- 2 Remove the cover of the system chassis.
- 3 Touch the system chassis or connect the copper end of the anti-static wrist strap to a metal component of the chassis to provide grounding.
- 4 Insert the ATMworks 350L into the appropriate bus slot. The EISA slots are longer than the PCI slots.
- 5 Press the card firmly into the slot to ensure that it is properly seated.
- 6 Using a Phillips screwdriver, tighten the retaining screw that holds the ATMworks 350L in place.
- 7 Replace the chassis cover and apply power to the machine. ■

Digital Equipment Corporation's ATMworks 350L is compliant with the PCI 2.1 specification, which describes operation requirements. However, refer to the system manufacturer's documentation for any system-specific installation instructions.

Initial Hardware Verification Procedures

After you have installed the ATMworks 350L hardware, you need to run the **decdiag** diagnostics utility provided with the card to ensure proper operation of the hardware.

The diagnostics software must be run from DOS. On a Windows NT system, you probably do not have DOS loaded. If not, you need to boot from DOS (5.0 or greater) disks and then run the diagnostics procedure.



To initially test ATMworks 350L functionality

- 1 Insert a DOS 5.0 or greater boot diskette into the diskette drive and reboot the machine.
- 2 When the command prompt appears, remove the DOS diskette and insert the “**DOS Diagnostics**” diskette. Change the working drive to the diskette drive.
- 3 Issue the **decdiag** command:

```
A:\> decdiag
DOS/4GW Protected Mode Run-time Version 1.95
Copyright (c) Rational Systems, Inc. 1990-1993

Info for controller # 0 (DOS-PCI)
Factory ESI Address - 00:20:ea:00:08:28
Serial No.          - 2088
Linear Address      - 0x10400000
Board Id           - 0x00000420
Interrupt          - IRQ14 (INTREQ's 0x2)
Description        - ATMworks 350L : 155 Mbps SONET/SDH Multi-Mode Fibre
PCI Device Number  - 10
Diagnostic Version - 0.7
EDM:0>
```

← PCI Slot Number

- 4 If desired, list the **decdiag** command set using the **help** command, as shown in Figure 2-1 on page 22.

Figure 2-1 Diagnostics Command Line “help” Listing

```
EDM:0> help
Digital Equipment Corporation ATM Adapter Diagnostic Program.

General commands supported :

info          - Display network interface controller general information.
dump          - Dump the contents of MIDWAY regs, PHY regs and SAR
              memory to a file.
modify        - Modify the contents of SAR memory.
display       - Display the contents of SAR memory, MIDWAY regs or PHY regs.
line_loop     - Set the phy in high speed line loopback.
loglevel      - Set the diagnostics log level.
loop          - Loop on specified list of diagnostic commands.
quit          - Quit diagnostic program.
what          - Display revisions of source files.

Specific diagnostic commands supported:

selftest      - Execute Self Test diagnostic tests.
bridge        - Execute Bridge diagnostic tests.
hbi_slave     - Execute Host Bus Interface Slave diagnostic tests.
hbi_dma       - Execute Host Bus Interface DMA diagnostic tests.
hbi_int       - Execute Host Bus Interface Interrupt diagnostic tests.
eeprom        - Execute EEPROM diagnostic test.
midway        - Execute MIDWAY diagnostic tests.
sar_mem       - Execute basic SAR Memory diagnostic tests.
sar_mem_e     - Execute extended SAR Memory diagnostic tests.
suni          - Execute SUNI diagnostic test.
atm_internal  - Execute ATM Internal Loopback tests.
atm_external  - Execute ATM External Loopback tests, (loopback cable
              required).

For help on a specific command, type "help" followed by command name.

EDM:0>
```

5 Execute the ATMworks 350L self-test by issuing the **selftest** command, which automatically executes each of the tests shown under “Specific diagnostic commands supported” in Figure 2-1 except for *hbi_int*, *sar_mem_e*, and *atm_external*.

```
EDM:0> selftest
Sun Jan 14 16:02:31 1996
Self Tests: function 0 all self tests.
PASSED
EDM:0>
```

- 6** Execute the SAR extended memory test by issuing the **sar_mem_e** command:

```
EDM:0> sar_mem_e
Sun Jan 14 16:02:31 1996
Extended Segmentation and Reassembly Tests:
function 0 all extended sar memory tests.
PASSED
EDM:0>
```

- 7** If you have an external loopback cable, you can use the **atm_external** command to test the external ATM connection to the ATMworks 350L.

- a** Attach the loopback cable to the ATMworks 350L ports, connecting transmit to receive.
- b** Issue the **atm_external** command:

```
EDM:0> atm_external
Sun Jan 14 16:02:31 1996
ATM External Tests: function 0 all external atm
tests.
PASSED
EDM:0>
```

- 8** If any of the diagnostic tests fail, record the error message displayed and contact a Digital Authorized VAR or distributor, or Digital Customer Service.
- 9** If the ATMworks 350L passed all of the above tests, remove the loopback cable (if necessary) and connect the product's ports to your ATM switch.

10 Type “**q**” or “**quit**” to exit the diagnostic utility.

```
EDM:0> quit  
C:\>
```

11 **Remove the DOS Diagnostics diskette from the drive and reboot the machine. ■**

Attaching Cables to the ATMworks 350L

Take care to protect optical connectors against dust and physical contact with all other objects. **Never** touch the ends of the cables.



All disconnected optical connectors must be covered with dust protecting caps. Do not remove these caps until immediately before mounting the ATMworks 350L in the chassis. (See Figure 2-2 below.)

Figure 2-2 Dust Protecting Cap

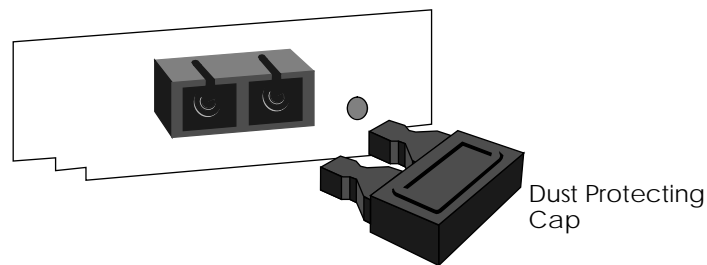
When no optical cable is connected to the ATMworks 350L, the protective cap supplied with the card should be plugged in to protect the optical transceiver.



When connecting optical cables between the ATMworks 350L and the switch, care must be taken so that the transmitter cable of the switch is connected to the receiver connector on the ATMworks 350L. Likewise, the switch's receiver cable must be connected to the transmitter connector on the ATMworks 350L. The LED on the card is lit when the ATMworks 350L is properly connected.

When using simplex (single) SC connectors, ensure that the transmitter connector from the switch is attached to the connector marked , and the receiver connector from the switch must be attached to the connector marked .

When using a duplex SC connector assembly, the connector can only be plugged in the correct way.

 **Note:** Be careful not to twist or bend the optical cable to the point where it may break the glass fiber inside the cable.

Figure 2-3 on page 26 provides relevant information about the RJ45 jack and connector.

Table 2-1 and Table 2-2 contain the technical specifications for the two types of ATMworks 350Ls discussed in this manual.

Figure 2-3 RJ45 Pinout for Category 5 UTP

The pinout of the jack on the ATMworks 350L is different than a standard Ethernet RJ45 pinout. Ethernet loopback connectors will not operate correctly on this card.

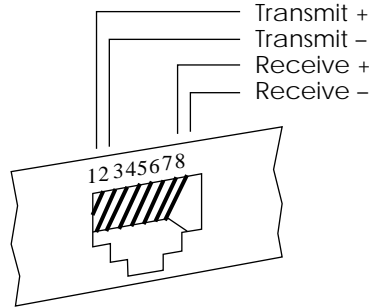

RJ45 Jack on UTP Category 5 ATMworks350L

RJ45 Connector

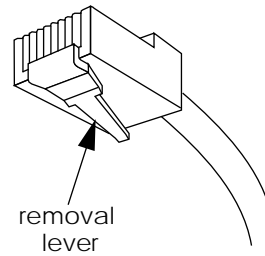

Once the connector is plugged into a board that is installed in a chassis, the removal lever on the connector may be hard to reach. Do not try to pull the connector out of the port without pushing up on the removal lever.

ATMworks 350L Specifications

Table 2-1 ATMworks 350L MMF Technical Specifications

	Size	Single slot adapter
PCI Interface	PCI Frequency	Up to 33MHz
	Bus Master	32 bit bus master capability, bursting up to 64-byte burst size
Optical Interface	Connector	SC style optical interface
	Multi-Mode Fiber	
	Core diameter	62.5 μm
	Cladding diameter	125 μm
	Min. modal bandwidth	500 MHz*km
	Operating distance	0 to 2 km
	Line code	NRZ
	Line rate	155.52 Mbit per second
	Rate tolerance	± 100 ppm
Transmitter	Transmitter type	LED
	Wavelength	1260 to 1360 nm
	Max Spectral width	200 nm
	Mean Launched power	-20 to -14 dBm
	Minimum extinction ratio	10 dB
	Maximum rise time	3 ns
Recvr	Min sensitivity	-30 dBm
	Max overload	-14 dBm
	Path power penalty	1 dB
Power	Max 1.5 amps @ +5V $\pm 5\%$ Max 0.2 amps @ +12V	
Temperature	Operating: 0 to 70° C Non-operating, storage: -40 to 100° C	
Humidity	5% to 95% noncondensing	

Table 2-2 ATMworks 350L Cat 5 Technical Specifications

PCI Interface	Size	Single slot adapter
	PCI Frequency	Up to 33MHz
	Bus Master	32 bit bus master capability, bursting up to 64-byte burst size
Electrical Interface	Connector	RJ45, eight-contact, shielded Category 5 jack
	Unshielded Twisted Pair (UTP)	Category 5 (4 twisted pairs) unused pairs are common mode terminated.
	Operating distance	0 m to 100 m
	Line code	NRZ
	Line rate	155.52 Mbit per second
	Rate tolerance	±100 ppm
Transmitter	Transmitter type	Transformer-coupled differential line driver
	Differential Signal Level	940 mv to 1060 mv
	Rise/Fall time	1.5 ns to 3.5 ns
Receiver		Transformer-coupled differential line receiver with adaptive equalization
Power		Max 1.5 amps @ +5V ± 5% Max 0.2 amps @ +12V
Temperature		Operating: 0 to 70° C Non-operating, storage: -40 to 100° C
Humidity		5% to 95% noncondensing



Software Installation and Configuration

Installation Requirements

The installation of the ATMworks 350L software on a Windows NT system consists of a few basic operations. You will be using applications in Windows NT to install and configure the drivers.

Prior to performing this software installation, you should have already performed the following steps:

- 1 Installed the ATMworks 350L hardware.
- 2 You may have to run the BIOS Setup to configure the PCI board into the system. See the hardware installation instructions for your PC.
- 3 Loaded DOS 5.0 or greater and executed the **decdiag** diagnostics procedure.
- 4 Rebooted the PC.

To successfully install the ATMworks 350L software requires, at a minimum:

- ❖ 16 MB RAM minimum (32 MB recommended)
- ❖ 1 MB available disk space
- ❖ An Intel 486 processor or better
- ❖ Windows NT v3.5.1 or later

Configuration Parameters

There is particular information that you will need to enter when configuring the port on the ATMworks 350L and when each LAN Emulation Client is added. Multiple LANE clients are added as “logical adapters”; that is, the same “Add Adapter” procedure is used to add each subsequent client.

Configuring the Port Interface

There are four configuration parameters that can be set for the ATMworks 350L. These parameters are not specific to a particular client (logical adapter), but to the “port” through which the clients communicate with the physical interface on the adapter. Hence, they are referred to as “port configuration” parameters.

Slot Number

This is the slot number instance assigned by the system when the ATMworks 350L was installed. If the adapter is moved to a different slot, you may need to modify this slot number.

UNI Version

The UNI version may be set to **3.0** (default) or **3.1**. The UNI version used by the ATMworks 350L must match the version used by the connected switch. Check the switch configuration to determine how to configure the adapter.

Cell Frame Type

Specifies the standard to be used by the physical layer interface. The ATMworks 350L is configured to use the **SONET** (synchronous optical network) standard by default, but may be configured for **SDH** (synchronous digital hierarchy), which is the international standard. If the adapter is being installed outside the U.S., check to see if it should be configured to use SDH.

Empty Cell Type

This parameter specifies whether **Idle** (default) or **Unassigned** cells are transmitted from the end station when no valid cells are being transmitted. Unassigned

cells are added to the assigned cell stream (cells with a valid payload) to provide a continuous stream of cells. The receiving station will extract and discard any unassigned or invalid (idle) cells. Therefore, both cell types should be handled the same way by a switch or other receiving end station on the network. However, you may want to check your switch manufacturer's documentation to see if it handles unassigned and idle cells differently and configure the adapter accordingly.



Note: *The ATMworks 350L design adheres to the ITU-TS specification that calls for Idle cells to be sent when no assigned cells are being sent.*

Configuring the LANE Clients

During the adapter software installation, there are a few questions to be answered with regards to LAN emulation. These are listed below along with detailed explanations.

Using the ESI as the MAC Address

To configure the ATMworks 350L to run on an emulated LAN, you must uniquely identify each LAN Emulation Client (LEC) as a node on the network. In connection-oriented networks, a MAC address uniquely identifies each node. In an ATM network, an End Station Identifier (ESI) uniquely identifies each endpoint in the network. Each ATM adapter is configured at the factory with an ESI that is resident in PROM on the adapter.

By default, the driver uses the adapter's ESI as the Network Address of each LEC when registering with NDIS. If multiple LECs are configured on one adapter, each of them will have the same Network Address.

Two LECs having the same Network Address usually does not present a problem because each client is on a separate Emulated LAN (ELAN). However, if two or more of the LECs will be on ELANs that are bridged together, this will present a conflict. In such a case, you would need to assign a unique Network Address to any clients that will be on bridged ELANs instead of using the default ESI.

During installation, you can specify a different Network Address to be registered with NDIS instead of the

adapter's ESI. The address of the LEC is stored in the Configuration Registry database.

The Network Address must be entered in hexadecimal characters, in the following format:

XX-XX-XX-XX-XX-XX

Example: 00-20-EA-00-30-16

Bypassing the LECS

Some switches available today do not provide a LAN Emulation Configuration Server. The LEC on the ATMworks 350L can still be used, however, if you connect directly to a LAN Emulation Server. Each LEC can be configured to connect to either an LECS or an LES.

Using the “well-known” LECS Address

If you will be connecting the LEC to an LECS, you may want to set the LECS address to the “well-known” address. This address is specified in the LANE Specification as:

47-0079:0000:0000:0000:0000:0000-00a0:3e00:0001-00

You may not want to use the well-known address because it starts with the prefix “47” and your switch may not support this prefix. Or, there may be more than one LECS on your network and you need to specify the address of the particular LECS to connect with.

Setting an ELAN Name

The ATMworks 350L software allows the specification of a specific emulated LAN for the LEC to join. You can enter up to a 32-character name of an ELAN during the software installation.

The ELAN name is passed by the LEC to the LECS when the software is trying to configure an ELAN or an LECS is trying to join the given ELAN. However, specification of an ELAN name will not guarantee that the LEC will be joined to the specified ELAN. The membership of an LEC in an ELAN is decided by the LES.

Software Installation Procedure

The following procedure describes the loading and configuration of the driver software. You will need the following information to complete the procedure:

- ❖ IP address for the ATMworks 350L
- ❖ Subnet mask for the ATM subnet
- ❖ Default gateway IP address, if known
- ❖ An LECS address (either custom or the well-known address).

 **Note:** *You must be logged on to Windows NT as the system administrator to execute this procedure.*



To install the ATMworks 350L driver software

- 1 Insert the Digital Equipment Corporation Orca software diskette included with the ATMworks 350L into an available diskette drive.
- 2 In the Program Manager window, double-click on the **Main** icon.
- 3 In the Main window, double-click on **Control Panel**.

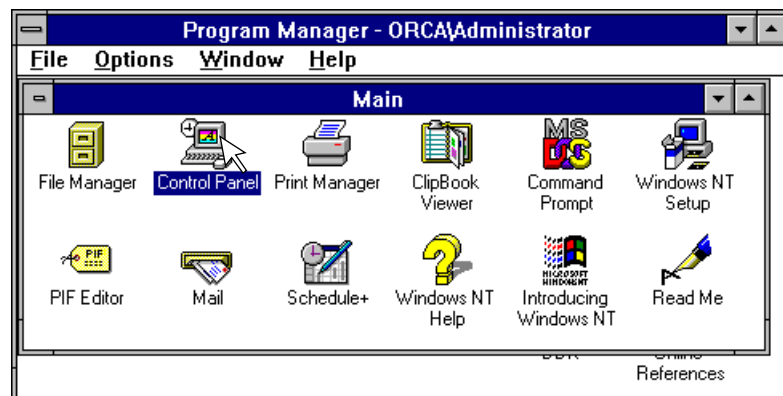

4 In the Control Panel window, double-click on **Network**.

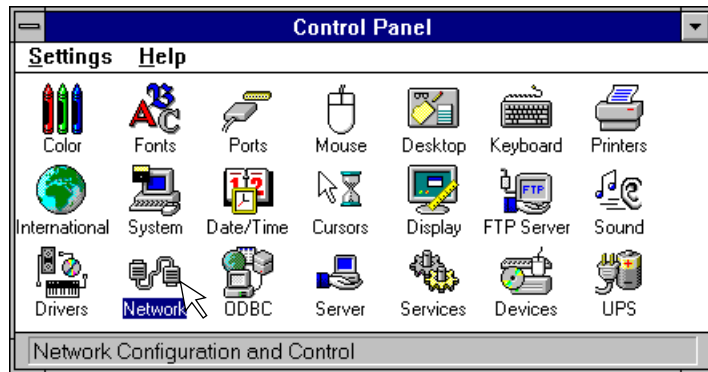

5 When the Network Settings window appears, click on the button labeled **Add Adapter**.

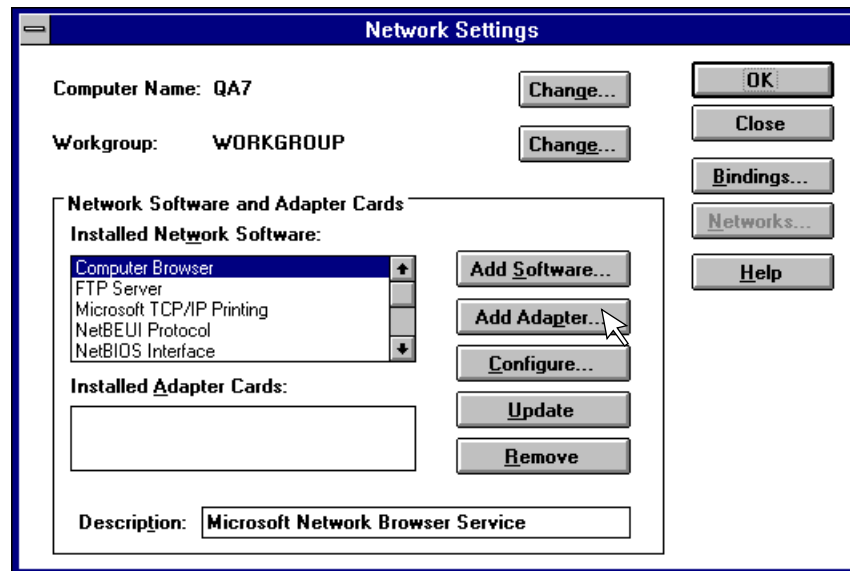

- 6 When the Add Network Adapter window appears, press on the “down” arrow in the “Network Adapter Card” list and scroll to the end.

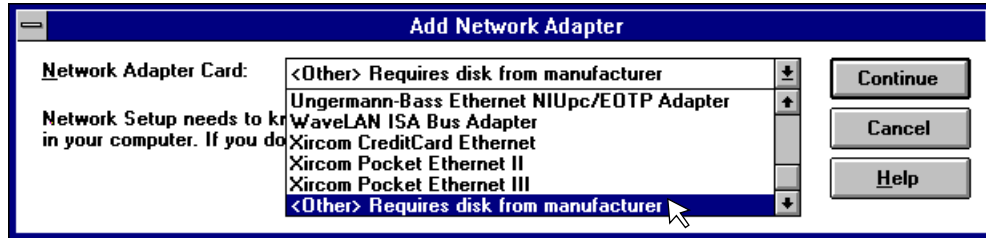

- 7 Select “<Other> Requires disk from manufacturer”, then click on the **Continue** button.
- 8 The Insert Disk window appears, indicating that the default location for the installation file is on the diskette in the A: drive. Press **<Enter>** or click on the **OK** button.

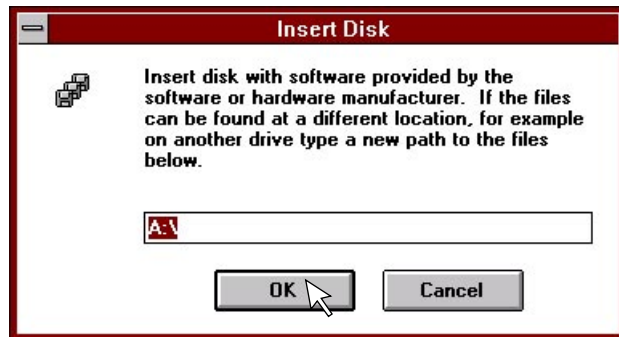

- 9 The Select OEM Option window appears, showing the type of driver that is going to be loaded. Click on **OK**.

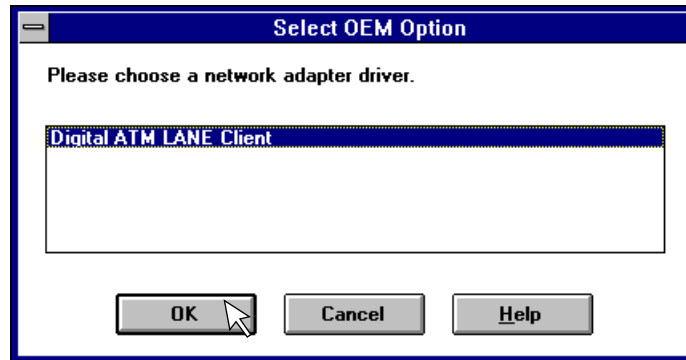

- 10 Once the file has been loaded, the LAN Emulation Client Configuration window appears. You use this window to configure the first LAN Emulation Client (LEC).

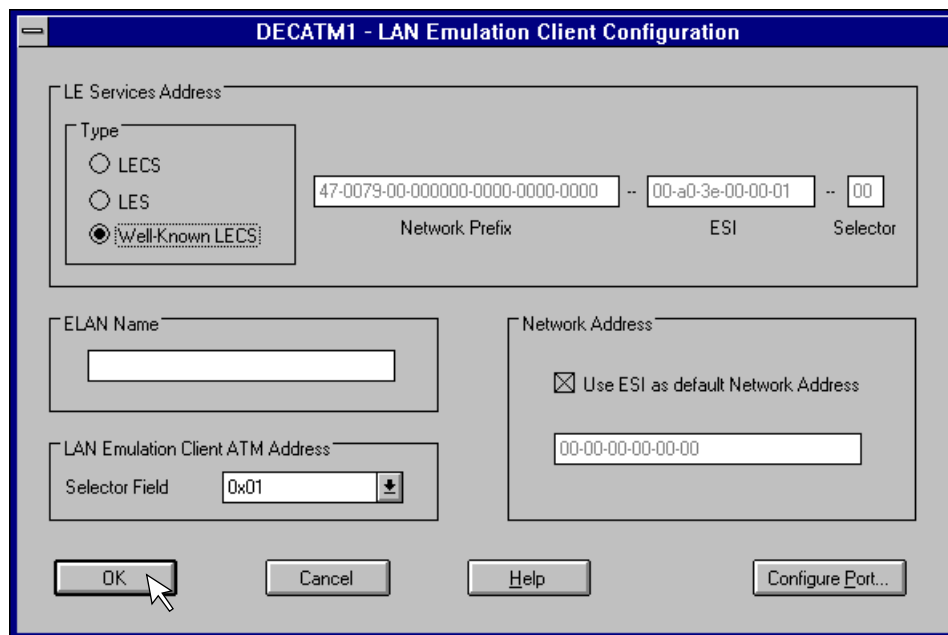

To accept the default configuration for the LEC, simply click **OK**.

The following flowchart is intended to help step you through the decisions to be made concerning the configuration of LAN Emulation.

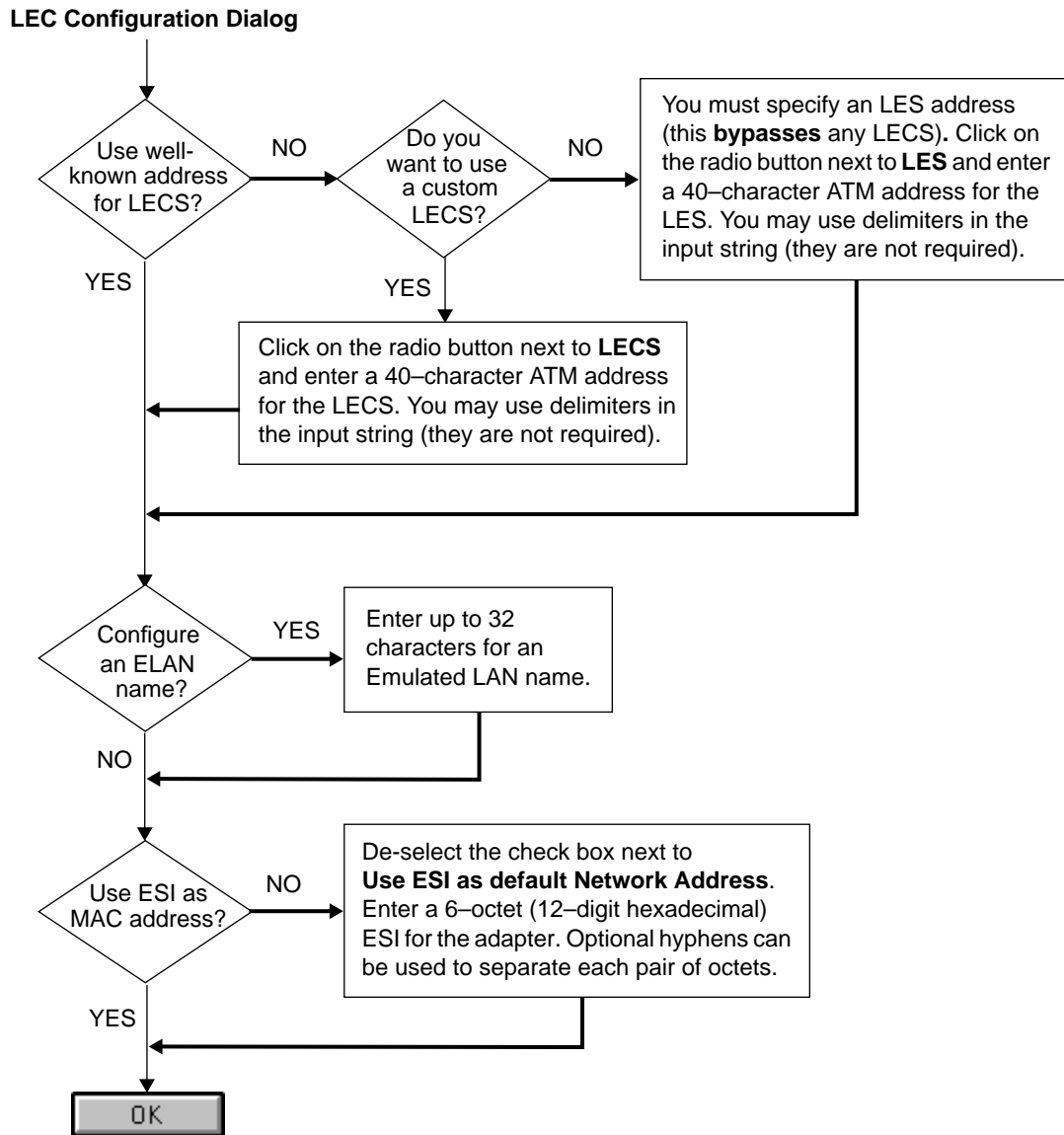

- 11 If you wish to configure the physical port on the ATMworks 350L, press the **Configure Port** button to bring up the Port Configuration window. Otherwise, skip to step 12.

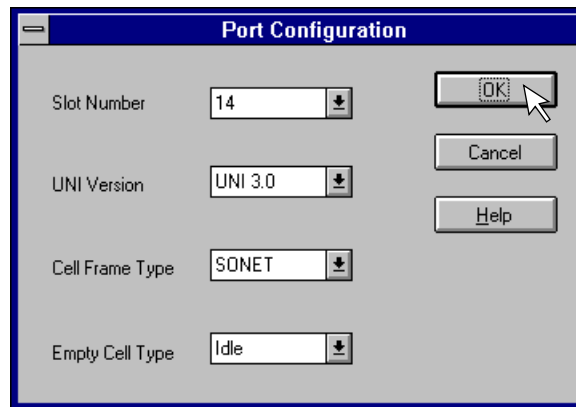

- a In the **Slot Number** field, you can enter the number of the slot in which the adapter is installed. You can obtain this number from the EISA configuration program or via the **endiag** utility for PCI.
 - b If you will be using UNI 3.1 instead of UNI 3.0, press **<Enter>** at the **UNI Version** field. A window displays the version choices. Select “UNI 3.1” and press **<Enter>**.
 - c If you will be using SDH instead of SONET, press **<Enter>** at the **Cell Frame Type** field. A window displays the type choices. Select “SDH” and press **<Enter>**.
 - d If you want empty cells to be unassigned instead of idle, press **<Enter>** at the **Empty Cell Type** field. A window displays the type choices. Select “Unassigned” and press **<Enter>**.
 - e When you have finished configuring the port, press the **OK** button to return to the LAN Emulation Client Configuration window.
- 12 When you have finished configuring the LEC, press the **OK** button.
 - 13 The *Network Settings* window reappears. The “Installed Adapter Cards” list should now show the LANE Client

that you just configured (it does not have to be highlighted). Click on **OK**.

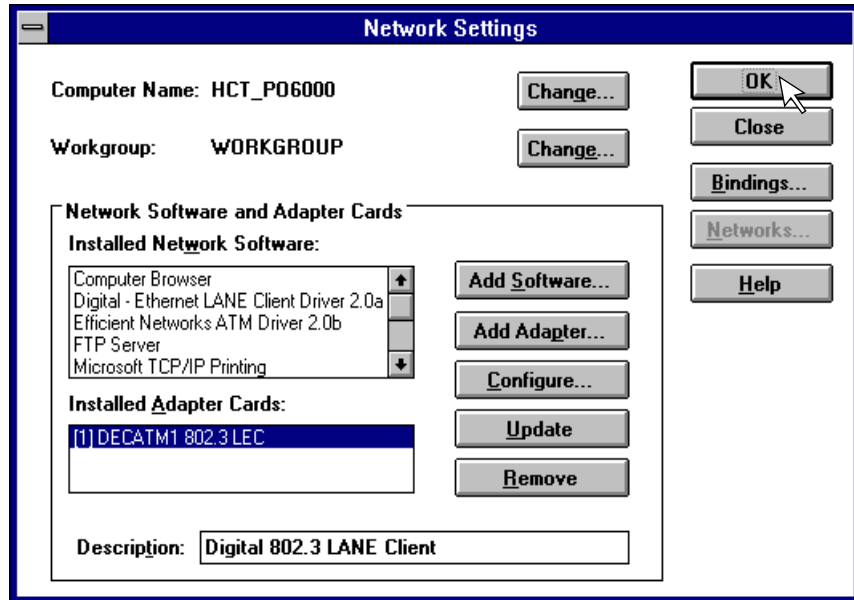

- 14 Your system may be configured to connect to a Novell NetWare system using NWLink. If so, a dialog box may appear that asks for an **NWLink IPX/SPX Protocol Configuration**. Simply click on **OK**.

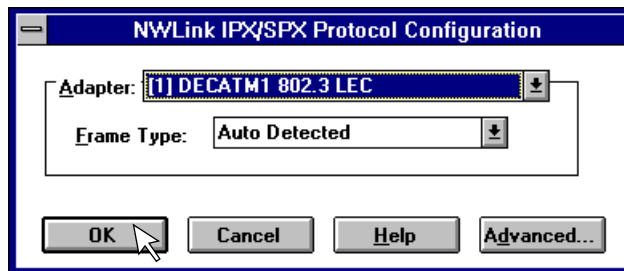

- 15 Once the network configuration is done, the TCP/IP Configuration window appears. Select the ATMworks 350L that you are configuring, scrolling down the list as necessary.

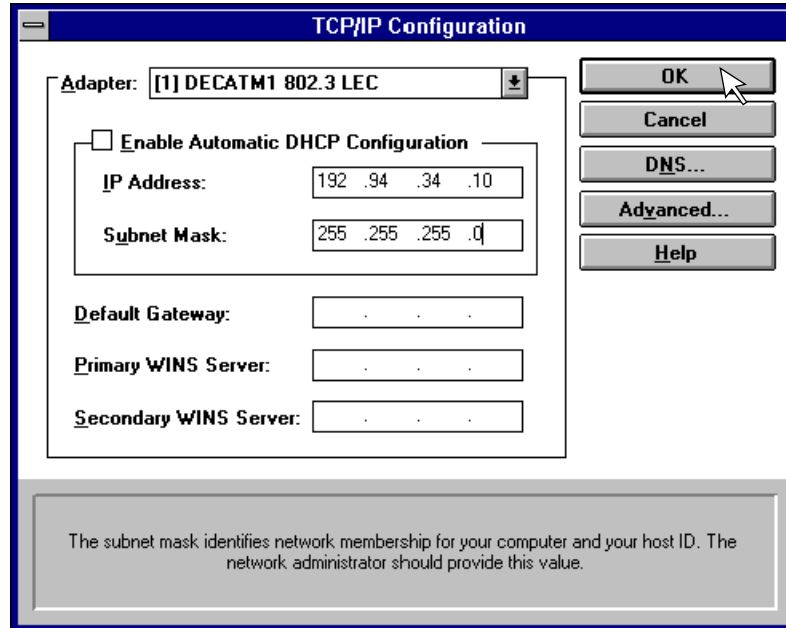

16 Enter the **IP Address** of the ATMworks 350L card.



CAUTION: *The LEC must be on a totally separate network from any existing Ethernet or Token Ring networks you already have configured.*

17 Enter the appropriate **Subnet Mask** for the ATMworks 350L's network.

18 If you have a **Default Gateway**, enter its IP address.



Note: You can see a list of all currently installed and configured network interfaces by bringing up an MS-DOS window and entering **ipconfig /all** at the prompt.

19 Click on **OK**. The Network Settings Change window appears, displaying an alert message telling you that you need to reboot.

20 If you wish to configure another LEC, click on **Don't Restart Now**, and refer to the next procedure. Otherwise, *remove the software diskette* from the drive and click on the **Restart Now** button.



To configure another LAN Emulation Client (LEC)

- 1 On the Network Settings window appears, click on **Add Adapter**.
- 2 On the Add Network Adapter window appears, scroll down the “Network Adapter Card” list and select the **Digital Equipment Corporation ATM Client**. Then click **Continue**.
- 3 The LAN Emulation Client Configuration window appears. Refer to the flow chart on page 37 for information about how to configure a LEC.
- 4 When you have finished configuring the LEC, press the **OK** button on the LAN Emulation Client Configuration window.
- 5 On the Network Settings window, the “Installed Adapter Cards” list should now show the LANE Client that you just configured (it does not have to be highlighted). Click on **OK**. (See step 13 on page 38.)
- 6 On the TCP/IP Configuration window, select the LEC that you are configuring, scrolling down the list as necessary.
- 7 Enter the **IP Address** of the new LEC.



CAUTION: *The LEC must be on a totally separate network from any existing Ethernet or Token Ring networks you already have configured.*

- 8 Enter the appropriate **Subnet Mask** for the IP address you just entered.
- 9 If you have a **Default Gateway**, enter its IP address.
- 10 Click on **OK**. The Network Settings Change window appears, displaying an alert message telling you that you need to reboot.
- 11 If you wish to configure another LEC, click on **Don't Restart Now**, and go back to the beginning of this procedure. Otherwise, *remove the software diskette* from the drive and click on the **Restart Now** button.

Removing the Software

To remove the ATM adapter software, you must individually remove each LAN Emulation Client (logical adapter) that has been configured. When the last client is removed, the installed software is deleted from the system.



To remove the software:

- 1 In the Program Manager window, select the **Main ==> Control Panel ==> Network**.
- 2 From the **Installed Adapter Cards** list, select the logical ATM adapter to be removed.
- 3 Click on the **Remove** button.

After the system is rebooted, the software and LECs will be removed.

Moving the ATMworks 350L

If you move the ATM adapter to a different slot, the configuration information in the registry must be updated. You can update the registry via the **Configure** button on the Network Settings window.



To update the registry with the new adapter slot information:

- 1 In the Program Manager window, select the **Main ==> Control Panel ==> Network**.
- 2 Select an LEC from the **Installed Adapter Cards** list and select the **Configure** button.

This brings up a dialog that allows you to change the slot number. The new slot number is displayed by default.

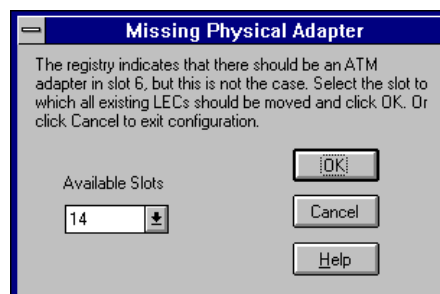

- 3 Click **OK** on the pop-up dialog.
- 4 Next, click **OK** on the LAN Emulation Client Configuration dialog that is also displayed. Restart the system to allow the changes to take effect.

Updating the Software

You can also easily upgrade the ATMworks 350L software without modifying the configuration of the adapter.

From the **Main** window, select **Control Panel**; then select **Network** on the Control Panel window. Insert the diskette containing the new software in a free diskette drive, then click on the **Update** button.

If the software on the diskette is newer than the software on your system, the system will copy the new files and return control to the Network Settings window.

Verifying Operations

After the ATMworks 350L is installed and configured and the system has been rebooted, you can review system events, via the Windows NT Event Viewer, to verify correct operation of the ATMworks 350L.

You access the Event Viewer by selecting the **Administrative Tools** program from within the Program Manager, and then selecting the **Event Viewer** icon on the *Administrative Tools* window.



When the ATMworks 350L has been installed properly and is functioning correctly, you will see the following sequence of events in the Event Viewer:

Date	Time	Source	Category	Event	User
6/10/96	10:55:18 AM	DECATM	None	4004	N/A
6/10/96	10:55:07 AM	DECATM	None	1002	N/A
6/10/96	10:55:03 AM	Service Control Mar	None	7000	N/A
6/10/96	10:55:03 AM	NetBT	None	4311	N/A
6/10/96	10:55:03 AM	NetBT	None	4307	N/A
6/10/96	10:55:03 AM	DECATM	None	3008	N/A
6/10/96	10:55:03 AM	DECATM	None	2002	N/A
6/10/96	10:55:02 AM	Service Control Mar	None	7001	N/A
6/10/96	10:55:02 AM	Service Control Mar	None	7022	N/A
6/10/96	10:50:26 AM	Service Control Mar	None	7024	N/A

The Event Viewer lists the most recent message first, so that the events will be listed in reverse order. The following table shows the messages that should be in the Event Viewer when the ATMworks 350L is functioning properly.

Table 3-1 Event Log Messages Under Normal Conditions

Event No.	Message	Description
4004	Active	LAN Emulation Client is operational.
3008	Q93B UP/Connected	Q93B signalling connection is established.
2002	QSAAL Up	QSAAL signalling is functioning properly.
1002	ILMI Up (Registered)	ILMI address registration completed successfully.

If any of these messages are missing, or other messages have been logged, refer to Appendix A of this guide for more information and the necessary operator actions.

Event Viewer Messages

Event Categories

The following sections describe the messages that can be found in the Event Viewer. The messages (events) are categorized as follows:

1xxx ILMI messages (address registration)

2xxx QSAAL messages (signalling)

3xxx Q93B messages

4xxx LAN Emulation Client (LEC) messages

5xxx ATM Adaptation Layer (AAL) messages

ILMI messages

1000 ILMI Resource Unavailable.

Msg Type: Warning

Indication: Allocation failure on internal buffer resources.

Action: Make sure the system is configured with enough RAM, or try rebooting the system; if problem persists, call a Digital Authorized VAR or distributor, or Digital Customer Service.

1002 ILMI UP (Registered).

Msg Type: Informational

Indication: ILMI address registration completed successfully.

Action: If this event is not present in the log, ILMI failed address registration. Check the switch configuration and verify that it supports address registration.

1003 ILMI DOWN (Registering).

Msg Type: Warning

Indication: ILMI SAP has gone down, possibly because the ENI software has lost the ILMI connection with the switch.

Action: ILMI should try to come back up, which will cause Event 1002 to be logged. If it is not, verify that the switch is functioning properly.

- 1004 ILMI Invalid Event.
Msg Type: Error
Indication: ILMI has switched into an unknown event.
Action: Check the switch documentation to ensure that the switch supports ILMI registration.
- 1006 ILMI PVC/VCC created.
Msg Type: Informational
Indication: ILMI connection (VCI #16) was successfully created.
- 1007 ILMI PVC/VCC deleted.
Msg Type: Informational
Indication: ILMI connection (VCI #16) was released.

QSAAL Messages

- 2000 QSAAL Resource Unavailable.
Msg Type: Warning
Indication: Allocation failure on an internal buffer pool.
Action: Make sure the system is configured with enough RAM, or try rebooting the system; if problem persists, call a Digital Authorized VAR or distributor, or Digital Customer Service.
- 2001 QSAAL Invalid Parameter.
Msg Type: Error
Indication: An invalid QSAAL parameter was entered.
Action: Try rebooting the system; if problem persists, call a Digital Authorized VAR or distributor, or Digital Customer Service.
- 2002 QSAAL UP.
Msg Type: Informational
Indication: QSAAL has connected to the switch.
- 2003 QSAAL DOWN.
Msg Type: Warning
Indication: Invalid DL SAP event or invalid AAL SAP event.
Action: Try rebooting the system; if problem persists, call a Digital Authorized VAR or distributor, or Digital Customer Service.
- 2004 QSAAL Invalid Event.
Msg Type: Error
Indication: The QSAAL is no longer connected to the switch.
Action: Check to see that the switch is functioning properly.
- 2005 QSAAL Internal Protocol Error
Msg Type: Error
- 2006 QSAAL PVC/VCC created
Msg Type: Informational

2007 QSAAL PVC/VCC deleted
Msg Type: Informational

Q93B Messages

3000 DECATM Q93B Down - Max Restarts Sent.
Msg Type: Warning
Indication: Q93B SAP has gone down and cannot be restarted because the connection with the switch was lost.
Action: Check to see that the switch is functioning properly.

3001 DECATM Q93B VCC Down - Max Restarts Sent.
Msg Type: Warning
Indication: Q93B maximum restarts have been exhausted for this VCC.
Action: Check to see that the switch is functioning properly.

3002 DECATM Q93B SAP id Out of Range.
Msg Type: Error
Indication: Invalid network SAP; pointer=NULL.
Action: Try rebooting the system; if problem persists, call a Digital Authorized VAR or distributor, or Digital Customer Service.

3003 DECATM Q93B Event Not compatible with SAP State.
Msg Type: Error
Indication: Multiple binds to the same SAP or SAP is in inappropriate state.
Action: Try rebooting the system; if problem persists, call a Digital Authorized VAR or distributor, or Digital Customer Service.

3004 DECATM Q93B Unknown/Illegal Event.
Msg Type: Error
Indication: Unknown misrouted Q93B event.
Action: Try rebooting the system; if problem persists, call a Digital Authorized VAR or distributor, or Digital Customer Service.

3005 DECATM Q93B Invalid Parameter Values.
Msg Type: Error
Indication: Q93B event has invalid parameters.
Action: Try rebooting the system; if problem persists, call a Digital Authorized VAR or distributor, or Digital Customer Service.

3006 DECATM Q93B Resources Unavailable.
Msg Type: Error
Indication: Q93B memory allocation error.
Action: Make sure the system is configured with enough RAM, or try rebooting the system; if problem persists, call a Digital Authorized VAR or distributor, or Digital Customer Service.

- 3007 DECATM Q93B Disconnecting.
Msg Type: Warning
Indication: Q93B SAP is disconnecting from the switch because the switch has gone down.
Action: Check the status of the switch.
- 3008 DECATM Q93B UP/Connected.
Msg Type: Informational
Indication: Q93B SAP is up and connected.
- 3009 DECATM Q93B Restarting.
Msg Type: Informational
Indication: Q93B SAP is restarting.
- 3010 DECATM Q93B VPC down.
Msg Type: Warning
Indication: Q93B maximum restarts have been exhausted for this VPC.
Action: Check to see that the switch is functioning properly and reboot the system.
- 3011 DECATM Q93B Connecting.
Msg Type: Informational
Indication: Q93B is connecting.
- 3012 DECATM Q93B DOWN (ReConnecting).
Msg Type: Warning
Indication: Q93B is down and in the process of reconnecting.
Action: None.

LEC Messages

- 4000 DECATM Event Not Compatible with SAP state.
Msg Type: Warning
Indication: LEC is not in a compatible SAP state.
Action: Try rebooting the system; if problem persists, call a Digital Authorized VAR or distributor, or Digital Customer Service.
- 4001 DECATM Unknown or Misrouted Event.
Msg Type: Error
Indication: LEC is in a SAP state that should never happen.
Action: Try rebooting the system; if problem persists, call a Digital Authorized VAR or distributor, or Digital Customer Service.
- 4002 DECATM Invalid Parameter Values.
Msg Type: Error
Indication: LEC connection structure has a null pointer.
Action: Reboot the system.

- 4003 **DECATM Resource Unavailable.**
Msg Type: Error
Indication: LEC attempted to allocate memory and failed.
Action: Make sure the system is configured with enough RAM, or try rebooting the system; if problem persists, call a Digital Authorized VAR or distributor, or Digital Customer Service.
- 4004 **DECATM Active.**
Msg Type: Informational
Indication: LEC has attached to the LANE services.
Action: If this message is not logged, verify that the switch and LANE services host are functioning properly. Verify that the LES or LECS has been entered properly during software configuration.
- 4005 **DECATM LEC DOWN.**
Msg Type: Warning
Indication: LEC SAP has been disabled.
Action: Reboot the system.
- 4006 **DECATM LEC DOWN (Internal memory resources unavailable).**
Msg Type: Warning
Indication: LEC did not come up due to a lack of memory resources.
- 4007 **DECATM LEC DOWN (LES returned unsuccessful JOIN response).**
Msg Type: Warning
Indication: LEC could not join the ELAN because it was rejected by the LES.
Action: Check the LES configuration to determine why the LEC is not allowed to join. Look at MTU size, ELAN name mismatch, and LAN type mismatch, etc.
- 4008 **DECATM LEC DOWN (Bad LE_JOIN_RESPONSE: Invalid LAN type).**
Msg Type: Warning
Indication: LANE Server returned a LAN type that is not defined in LANE 1.0.
Action: Check the server configuration to ensure it is using a standard LAN type (either Ethernet or Token Ring).
- 4009 **DECATM LEC DOWN (LES LE_JOIN_RESPONSE: returned different MAXIMUM-FRAME-SIZE than sent).**
Msg Type: Warning
Indication: The LEC is down because the LANE server returned a different maximum frame size in the join response. The only frame size currently supported by the LEC is 1516.

- 4010 DECATM LEC DOWN (Bad LE_JOIN_RESPONSE: returned invalid MAXIMUM-FRAME-SIZE).
Msg Type: Warning
Indication: LANE Server returned a maximum frame size that is not defined in LANE 1.0.
Action: Check the server configuration to ensure it is using a standard maximum frame size.
- 4011 DECATM LEC DOWN (Bad LE_JOIN_RESPONSE: ELAN-NAME size too large).
Msg Type: Warning
Indication: LEC could not join the ELAN because the ELAN name returned by the LANE server is longer than 32 characters. Check the LANE server configuration.
- 4012 DECATM LEC DOWN (LES never returned JOIN response).
Msg Type: Warning
Indication: LANE server did not respond to the LEC's join request. This may indicate network congestion.
- 4013 DECATM LEC DOWN (Failed to get ARP response for BUS).
Msg Type: Warning
Indication: LEC failed to receive an LE ARP response. This may indicate BUS failures or misregistration of the BUS with the LES. Check the LANE server configuration to ensure that all services are operational.
- 4015 DECATM LEC DOWN (Failed to (un)register LAN destination).
Msg Type: Warning
Indication: LEC issued a register or unregister request to the LANE server and got no response.
- 4016 DECATM LEC DOWN (Control Direct VCC released due to LES disconnect).
Msg Type: Warning
Indication: The Control Direct VCC is the first connection made between the LEC and the LANE server. This message indicates that the LEC did not connect or has disconnected from the LANE server.
- 4017 DECATM LEC DOWN (Control Distribute VCC released).
Msg Type: Warning
Indication: The optional Control Distribute VCC is a response connection made from the LANE server to the LEC. This message indicates LEC has been disconnected from the ELAN.
- 4018 DECATM LEC DOWN (Multicast send VCC released).
Msg Type: Warning
Indication: The Multicast send VCC is a connection made from the LEC to the Broadcast Unknown Server (BUS). This message indicates LEC has been disconnected from the ELAN.

- 4019 DECATM LEC DOWN (Multicast Forward VCC released).
Msg Type: Warning
Indication: The Multicast Forward VCC is a response connection made from the Broadcast Unknown Server (BUS) to the LEC. This message indicates LEC has been disconnected from the ELAN.
- 4020 DECATM LEC DOWN (No multicast Forward VCC established).
Msg Type: Warning
Indication: The Multicast Forward VCC is a response connection made from the Broadcast Unknown Server (BUS) to the LEC. This message indicates the LEC timed out waiting for the connection to be made and is disconnected from the ELAN.
- 4021 DECATM LEC DOWN (Bad LE_CONFIGURE_RESPONSE: LEC sent LAN type "Ethernet" and received LAN type "Unspecified" from LECS).
Msg Type: Warning
Indication: Since the LEC sent a specific LAN type, LECS should have sent the same LAN type back.
- 4022 DECATM LEC DOWN (Bad LE_CONFIGURE_RESPONSE: LEC sent LAN type "TokenRing" and received LAN type "Unspecified" from LECS).
Msg Type: Warning
Indication: Since the LEC sent a specific LAN type, LECS should have sent the same LAN type back.
- 4023 DECATM LEC DOWN (Bad LE_CONFIGURE_RESPONSE: LEC sent LAN type "Ethernet" and received LAN type "TokenRing" from LECS).
Msg Type: Warning
Indication: Since the LEC sent a specific LAN type, LECS should have sent the same LAN type back.
- 4024 DECATM LEC DOWN (Bad LE_CONFIGURE_RESPONSE: LEC sent LAN type "TokenRing" and received LAN type "Ethernet" from LECS).
Msg Type: Warning
Indication: Since the LEC sent a specific LAN type, LECS should have sent the same LAN type back.
- 4025 DECATM LEC DOWN (Bad LE_CONFIGURE_RESPONSE: Invalid LAN type).
Msg Type: Warning
Indication: LECS returned a LAN type that is not defined in LANE 1.0.
Action: Check the LECS configuration to ensure it is using a standard LAN type (either Ethernet or Token Ring).

- 4026 DECATM LEC DOWN (Bad LE_CONFIGURE_RESPONSE: LEC sent a maximum frame size and received "Unspecified" from LECS).
Msg Type: Warning
Indication: Since the LEC sent a specific maximum frame size, LECS should have sent the same or smaller frame size back.
- 4027 DECATM LEC DOWN (LECS LE_CONFIGURE_RESPONSE: returned different MAXIMUM-FRAME-SIZE than sent).
Msg Type: Warning
Indication: The LEC is down because the LECS returned a different maximum frame size in the configure response. The only frame size currently supported by the LEC is 1516.
- 4028 DECATM LEC DOWN (Bad LE_CONFIGURE_RESPONSE: returned invalid MAXIMUM-FRAME-SIZE).
Msg Type: Warning
Indication: LECS returned a maximum frame size that is not defined in LANE 1.0.
Action: Check the LECS configuration to ensure it is using a standard maximum frame size.
- 4029 DECATM LEC DOWN (Bad LE_CONFIGURE_RESPONSE: ELAN-NAME size too large).
Msg Type: Warning
Indication: LEC could not configure because the ELAN name returned by the LECS is longer than 32 characters.
Action: Check the LECS configuration.
- 4030 DECATM LEC DOWN (LECS released configuration direct VCC).
Msg Type: Warning
Indication: The Configuration Direct VCC is the connection made between the LEC and the LECS. This message indicates that the LEC did not configure because it could not connect to the LECS.
- 4031 DECATM LEC DOWN (LECS returned unsuccessful config response).
Msg Type: Warning
Indication: LEC could not configure because it was rejected by the LECS.
Action: Check the LECS configuration to determine why the LEC is not allowed to configure. Look at MTU size, ELAN name mismatch, and LAN type mismatch, etc.
- 4032 DECATM LEC DOWN (LECS never returned config response).
Msg Type: Warning
Indication: LECS did not respond to the LEC's configure request. This may indicate network congestion.

- 4033 DECATM LEC DOWN (SAP REMOVED).
Msg Type: Error
Indication: LEC SAP has been deleted.
Action: Reboot the system.
- 4034 DECATM FAILED (LECS returned unsuccessful config response).
Msg Type: Error
Indication: LEC could not configure because it was rejected by the LECS. This message indicates the VERSION number of the LEC is higher than that supported by the LECS.
- 4035 DECATM FAILED (LECS returned unsuccessful config response).
Msg Type: Error
Indication: LEC could not configure because it was rejected by the LECS. This message indicates the parameters specified by the LEC are incompatible with the ELAN.
- 4036 DECATM FAILED (LECS returned unsuccessful config response).
Msg Type: Error
Indication: LEC could not configure because it was rejected by the LECS. This message indicates the LECS is unable to service the request because of insufficient table space or the ability to establish VCCs.
- 4037 DECATM FAILED (LECS returned unsuccessful config response).
Msg Type: Error
Indication: LEC could not configure because it was rejected by the LECS. This message indicates the LECS denied access because of security reasons.
- 4038 DECATM FAILED (LECS returned unsuccessful config response).
Msg Type: Error
Indication: LEC could not configure because it was rejected by the LECS. This message indicates the LECID field is not zero.
- 4039 DECATM FAILED (LECS returned unsuccessful config response).
Msg Type: Error
Indication: LEC could not configure because it was rejected by the LECS. This message indicates the LAN Destination is a multicast address, on an Ethernet/802.3 ELAN, or a Route Descriptor.

- 4040 DECATM FAILED (LECS returned unsuccessful config response).
Msg Type: Error
Indication: LEC could not configure because it was rejected by the LECS. This message indicates the source or target ATM address is not in a recognizable format.
- 4042 DECATM FAILED (LECS returned unsuccessful config response).
Msg Type: Error
Indication: LEC could not configure because it was rejected by the LECS. This message indicates the LEC is not recognized by the LECS.
- 4043 DECATM FAILED (LECS returned unsuccessful config response).
Msg Type: Error
Indication: LEC could not configure because it was rejected by the LECS. This message indicates the parameters supplied give conflicting answers. This may also indicate service is refused for no specific reason.
- 4044 DECATM FAILED (LECS returned unsuccessful config response).
Msg Type: Error
Indication: LEC could not configure because it was rejected by the LECS. This message indicates the LEC has not provided sufficient information to allow the LECS to assign it to a specified ELAN.
- 4045 DECATM LEC DOWN (LES returned unsuccessful JOIN response).
Msg Type: Error
Indication: LEC could not join the ELAN because it was rejected by the LES. This message indicates the VERSION number of the LEC is higher than that supported by the LES.
- 4047 DECATM LEC DOWN (LES returned unsuccessful JOIN response).
Msg Type: Error
Indication: LEC could not join the ELAN because it was rejected by the LES. This message indicates the parameters specified by the LEC are incompatible with the ELAN.
- 4048 DECATM LEC DOWN (LES returned unsuccessful JOIN response).
Msg Type: Error
Indication: LEC could not join the ELAN because it was rejected by the LES. This message indicates the SOURCE-LAN-DESTINATION duplicates a previously registered LAN Destination.

- 4049 DECATM LEC DOWN (LES returned unsuccessful JOIN response).
Msg Type: Error
Indication: LEC could not join the ELAN because it was rejected by the LES. This message indicates the SOURCE-ATM-ADDRESS duplicates a previously registered ATM Address.
- 4050 DECATM LEC DOWN (LES returned unsuccessful JOIN response).
Msg Type: Error
Indication: LEC could not join the ELAN because it was rejected by the LES. This message indicates the LES is unable to service the request because of insufficient table space or the ability to establish VCCs.
- 4051 DECATM LEC DOWN (LES returned unsuccessful JOIN response).
Msg Type: Error
Indication: LEC could not join the ELAN because it was rejected by the LES. This message indicates the LES denied access because of security reasons.
- 4052 DECATM LEC DOWN (LES returned unsuccessful JOIN response).
Msg Type: Error
Indication: LEC could not join the ELAN because it was rejected by the LES. This message indicates the LECID field is not zero.
- 4053 DECATM LEC DOWN (LES returned unsuccessful JOIN response).
Msg Type: Error
Indication: LEC could not join the ELAN because it was rejected by the LES. This message indicates the LAN Destination is a multicast address, on an Ethernet/802.3 ELAN, or a Route Descriptor.
- 4054 DECATM LEC DOWN (LES returned unsuccessful JOIN response).
Msg Type: Error
Indication: LEC could not join the ELAN because it was rejected by the LES. This message indicates the source or target ATM address is not in a recognizable format.

AAL Messages

5000 DECATM Power up SelfTest Failed
5001 DECATM EEPROM verification failed
5002 DECATM Manufacturing block verification failed
5003 DECATM SAR data line test failed
5004 DECATM SAR address line test failed
5005 DECATM SAR existence test failed
5006 DECATM SAR xor test failed
5007 DECATM Physical interface device initializing failed

Msg Type: Error

Indication: These messages indicate hardware problems in the ATMworks 350L.

Action: Run **decdiag** to verify that the card is bad; call a Digital Authorized VAR or distributor, or Digital Customer Service about product return procedures.

5008 DECATM Can not create receive buffer/packet pools
5009 DECATM RX buffer descriptor pool initialization failed
5010 DECATM RX packet descriptor pool initialization failed
5011 DECATM Could not allocate adapter structure
5012 DECATM Could not allocate rx packet memory
5013 DECATM Could not allocate rx queuing memory

Msg Type: Error

Indication: The system cannot allocate memory; system resources not available. May not be enough RAM in the system for all of the installed ATMworks 350Ls.

Action: Check the RAM requirements for all ATMworks 350Ls currently installed against the currently configured system RAM.

5014 DECATM Can not find "SlotNumber" in the registry hive
5015 DECATM Can not find "BusType" in the registry hive

Msg Type: Error

Indication: Installation program did not create proper configuration entries in the registry

Action: Remove and reinstall the ATMworks 350L software; if problem persists, call a Digital Authorized VAR or distributor, or Digital Customer Service.

5016 DECATM Board type does not match what is stated in the registry
5017 DECATM Unknown "BusType" found in registry

Msg Type: Error

Indication: The ATMworks 350L has been moved to a different slot.

Action: Use the configuration procedure in the manual to reconfigure the board.

- 5018 DECATM Unknown Midway id
Msg Type: Error
Indication: The NIC is of an unknown type or board is not responding properly.
Action: Run **decdiag** to verify that the ATMworks 350L is bad; if so, call a Digital Authorized VAR or distributor, or Digital Customer Service about product return procedures.
- 5019 DECATM No ATM boards where found in the system
Msg Type: Error
Indication: No ATMworks 350Ls found or the ATMworks 350L is not functioning properly.
Action: Attempt to reinstall the ATMworks 350L; if problem persists, call a Digital Authorized VAR or distributor, or Digital Customer Service.
- 5020 DECATM Could not map in board space
Msg Type: Error
Indication: NT "NdisMapIoSpace" call failed to map in ATMworks 350L.
Action: Make sure the system is running Windows NT 3.51 or later. If so, call a Digital Authorized VAR or distributor, or Digital Customer Service.
- 5021 DECATM Could not initialize the board interrupt
Msg Type: Error
Indication: NT "NdisInitializeInterrupt" call failed to map in ATMworks 350L.
Action: Make sure the system is running Windows NT 3.51 or later. If so, call a Digital Authorized VAR or distributor, or Digital Customer Service.
- 5022 DECATM Uninitializing driver
Msg Type: Informational
Indication: The system is uninitializing the ATMworks 350L driver in "MacShutdown".
- 5023 DECATM The ATM adapter hardware is in a FATAL ERROR state (LERR acknowledgment)
5024 DECATM The ATM adapter hardware is in a FATAL ERROR state (dma error acknowledgment)
5025 DECATM The ATM adapter hardware is in a FATAL ERROR state (tx identifier mismatch)
5026 DECATM The ATM adapter hardware is in a FATAL ERROR state (tx dma overflow)
Msg Type: Error
Indication: Hardware is in a fatal state.
Action: Reboot the system; if problems persist, call a Digital Authorized VAR or distributor, or Digital Customer Service.

- 5027 DECATM Bad Midway rx ident mismatch found
Msg Type: Error
Indication: Hardware pointers have been corrupted.
Action: Reboot the system; if problems persist, call customer support.
- 5028 DECATM PDU size is larger than rx segment
Msg Type: Error
Indication: PDU has been received that is larger than the maximum allowable receive packet size. The source system is violating the maximum Ethernet packet size for LAN Emulation.
Action: Determine the source of the packet transmission and correct the PDU size at the source.
- 5029 DECATM TX bandwidth request is larger than max line rate
5030 DECATM RX Bandwidth request is larger than max line rate
Msg Type: Warning
Indication: The source system is requesting a transmit/receive rate that is greater than the maximum line rate.
- 5031 DECATM TX connection does not exist
Msg Type: Warning
Indication: Data is being transmitted on an invalid VPI/VCI.
- 5032 DECATM TX bandwidth is set to zero
Msg Type: Warning
Indication: An attempt is being made to transmit data on a zero bandwidth connection.
- 5033 DECATM TX sdu is larger than max sdu size
Msg Type: Warning
Indication: SDU size is greater than the maximum allowable SDU size.
- 5034 DECATM TX sdu will not fit in segmentation channel
Msg Type: Warning
Indication: SDU size is greater than the hardware transmission channel size.
- 5035 DECATM Base address equals zero. CheckedAddress must be defined in the registry.
Msg Type: Error
Indication: The ATMworks 350L hardware address has been set to zero, which is invalid.
Action: "CheckedAddress" value in the registry must be defined in the HKEY_LOCAL_MACHINE/SYSTEM/CurrentControl/Set/Services/DECATMx/Parameters
Set the "CheckedAddress" value equal to the "Linear Address" retrieved from **decdiag** on the ATMworks 350L. This error will only occur if the NT Checked OS is being used.

5036 DECATM Can not create connection, out of nic resources.
Msg Type: Error
Indication: The number of virtual channels that can be created has been exceeded.
Action: Release some unneeded connections before attempting to create more.

A

AAL – ATM Adaptation Layer: one of the three layers that make up the OSI model for ATM.

AAL1 – Supports connection-oriented services that require constant bit rates.

AAL2 – Supports connection-oriented services that do not require constant bit rates.

AAL3/4 – Intended for both connection-oriented and connectionless variable bit rate services.

AAL5 – Supports connection-oriented variable bit rates.

ABR – Available Bit Rate

AFI – Authority and Format Identifier: identifies the authority allocating the ATM address. Specified in the first octet of the ATM address.

AII – Active Input Interface (Used in UNI PMD specs for Copper/Fiber)

AIS – Alarm Indication Signal (UNI Fault Management)

AMS – Audiovisual Multimedia Service

AOI – Active Output Interface (Used in UNI PMD specs for Copper/Fiber)

Area – Part of a standard ATM Address that identifies a unique area within a Routing Domain.

ARP – Address Resolution Protocol

ASN.1 – Abstract Syntax Notation One

Asynchronous – Signals that are sourced from independent clocks. These signals generally have no relation to each other and so have different frequencies and phase relationships. Compare to “plesiochronous” signals.

ATE – ATM Terminating Equipment (SONET)

ATM – Asynchronous Transfer Mode: a cell-relay based networking protocol.

ATM Address – A 20-byte address that uniquely identifies an ATM endpoint. Three formats are specified in UNI 3.0: DCC, ICD, and E.164.

B

BCD – Binary Coded Decimal

BECCN – Backward Explicit Congestion Notification

BER – Basic Encoding Rules (ASN.1) or Bit Error Rate (link quality specification/testing)

BIP – Bit Interleaved Parity (e.g., SONET BIP-8 for path error monitoring)

BIPV – Bit Interleaved Parity Violation

B-HLI – Broadband High Layer Information

B-ICI – Broadband Intercarrier Interface

B-ISDN – Broadband Integrated Services Digital Network

B-ISSI – Broadband Inter-Switching System Interface

B-LLI – Broadband Low Layer Information

BOM – Beginning of Message

BSS – Broadband Switching System

BUS – Broadcast Unknown Server

C

CAC – Connection Admission Control
CBR – Constant Bit Rate
CDV – Cell Delay Variation
CEI – Connection Endpoint Identifier (UNI 3.0)
CES – Circuit Emulation Service
CIP – Classical IP: describes the typical LAN-based network paradigm where wires and local LAN segments connect IP end-stations and routers.
CIR – Committed Information Rate
CLP – Cell Loss Priority
CMISE – Common Management Information Service Element
CNM – Customer Network Management
CPCS – Common Part Convergence Sublayer
CPE – Customer Premise Equipment
CPI – Common Part Indicator
CRF(VC) – Virtual Channel Connection Related Function (related to UPC/UNI 3.0)
CRF(VP) – Virtual Path Connection Related Function (related to UPC/UNI 3.0)
CRS – Cell Relay Service
CS – Convergence Sublayer (as in CS_PDU)

D – F

DCC – Data Country Code: a type of ATM Address format whose AFI is 39. The DCC is a two-octet field after the first octet in a DCC ATM address. The DCC is expressed in BCD and identifies the country in which an address is registered per ISO 3166.
DSX – Digital Signal Cross-Connect
DXI – Data Exchange Interface
E.164 – a type of ATM Address format whose AFI is 45. The E.164 field takes up eight octets

of an E.164 ATM address and is expressed in BCD and hex. This field specifies ISDN numbers, which include telephone numbers.

EFCI – Explicit Forward Congestion Indication
EOM – End of Message
ESI – End Station Identifier: a 6-octet field in the ATM Network Address that uniquely identifies an ATM endpoint within an Area in a Routing Domain.
FEA – Functional Entity Action (UNI 3.0, C.3.2.3)
FEBE – Far End Block Error (SONET)
FECN – Forward Explicit Congestion Notification

G – I

GCRA – Generic Cell Rate Algorithm
GFC – Generic Flow Control
HEC – Header Error Control
ICD – International Code Designator: a type of ATM Address format whose AFI is 47. The ICD is a two-octet field following the AFI field in a DCC ATM address. This field, expressed in BCD, identifies an international organization registered by the British Standards Institute.
IETF – Internet Engineering Task Force
ILMI – Interim LAN Management Interface: currently implemented using SNMP.
IPX – Internetwork Packet Exchange
Isochronous – Signals which are dependent on some uniform timing or carry their own timing information embedded as part of the signal.

L

LAN – Local Area Network
LCD – Loss of Cell Delineation (also seen as OCD).

LCT – Last Compliance Time (used in GCRA definition)

Leaky bucket – A method of data traffic flow regulation using a buffer (bucket) and a regulator to present the data to the network at a specific rate.

LEC – LAN Emulation Client

LECS – LAN Emulation Configuration Server

LES – LAN Emulation Server

LIS – Logical IP Subnetwork: used to refer to an ATM network environment implemented using Classical IP and ARP.

LLC Encapsulation – Logical Link Control Encapsulation: a method of adding headers to AAL5 CPCS-PDUs to allow several protocols to be carried over the same VC. The header allows the receiver to identify the protocol of the routed or bridged PDU.

LOF – Loss of Frame (UNI Fault Management)

LOP – Loss of Pointer (UNI Fault Management)

LOS – Loss of Signal (UNI Fault Management)

LTE – Line Terminating Equipment (SONET)

M – N

MAC – Media Access Control

MBS – Maximum Burst Size

MID – Message Identifier

MTU – Maximum Transmission Unit: maximum allowable size of a PDU on an ATM network. The MTU size for IP stations operating over ATM is 9180 octets. With an LLC/SNAP header (8 octets), the default ATM AAL5 PDU size is 9188 octets.

NBMA– Non-Broadcast Multiple Access

NEXT– Near End Crosstalk (adverse phenomenon associated with high frequencies over twisted-pair wiring, measured in decibels)

NIU – Network Interface Unit

NLPID – Network Layer Protocol Identifier

NMS– Network Management Station

NNI – Network Node Interface

NSAPA – Network Service Access Point Address: OSI address format used as the model for the ATM Address defined in UNI 3.0.

O – R

OAM – Operations and Management

OCD – Out-of-Cell Delineation (UNI 3.0 Section 2.1.2.2.2)

ODI – Open Data-link Interface (Novell)

PCR – Peak Cell Rate (UNI 3.0)

PDU – Protocol Data Unit: the common term for the frames sent in frame-relay networking protocols.

PLCP – Physical Layer Convergence Procedure/Protocol

PL-OU – Physical Layer Overhead Unit (UNI physical layer frame definition)

PMD – Physical Media Dependent

PMP – Point to MultiPoint (UNI 3.0)

POH – Path Overhead (SONET)

POI – Path Overhead Indicator

PTE – Path Terminating Equipment (SONET)

PTI – Payload Type Identifier

PVC – Permanent Virtual Connection

QoS – Quality of Service

RDI – Remote Defect Indicator (UNI Fault Management)

RIP – Routing Information Protocol

S

SAAL – Signalling ATM Adaptation Layer
SAR – Segmentation and Reassembly (as in SAR_PDU)
SCR – Sustainable Cell Rate (UNI 3.0)
SDH – Synchronous Digital Hierarchy
SDU – Service Data Unit (as in AAL_SDU)
SEAL – Simple and Efficient Adaptation Layer
SECB – Severely Errored Cell Block
Selector – The last octet of the ATM Address (currently undefined in the UNI 3.0 specification).
SIR – Sustained Information Rate
SMDS – Switched Multi-Megabit Data Service
SNAP – SubNetwork Attachment Point (see IEEE 802.1a)
SNMP – Simple Network Management Protocol
SONET – Synchronous Optical Network
SSCF – Service Specific Coordination Function
SSCS – Service Specific Convergence Sublayer
SSCOP – Service Specific Connection Oriented Protocol
STE – Section Terminating Equipment (SONET)
SVC – Switched Virtual Connection
Synchronous – Signals that are sourced from the same timing reference. These may have the same frequency.

T

TAT – Theoretical Arrival Time (used in GCRA definition)
TAXI – Transparent asynchronous

transmitter/receiver interface

TC – Transmission Convergence

Traffic shaping – forcing data traffic to conform to a certain specified behavior. Usually this is a worst case or worst case plus average rate.

TUC – Total User Cell count

TUCD – Total User Cell Difference

UME – UNI Management Entity (used in ILMI definition)

UNI – User-Network Interface

UPC – Usage Parameter Control

V

VBR – Variable Bit Rate

VC – Virtual Channel

VCC – Virtual Channel Connection

VCI – Virtual Channel Identifier

VCL – Virtual Channel Link (UNI 3.0)

VINCE – Vendor Independent Network Control Entity

VP – Virtual Path

VPC – Virtual Path Connection

VPCI – Virtual Path Connection Identifier

VPI – Virtual Path Identifier

VPL – Virtual Path Link (UNI 3.0)

VPT – Virtual Path Terminator (UNI 3.0)

W

well-known address – ATM address that is commonly used for a LAN Emulation Configuration Server (LECS):

47-0079:0000:0000:0000:0000-00a
0:3e00:0001-00

A

- addresses
 - defining IP for ATM, 13
 - use of subnet mask, 13
- ASIC chip
 - functionality, 10
- assigned cells, 30
- ATM Adaptation Layer 5 (AAL5)
 - implementation, 10
- ATMworks 350L
 - cabling, 25
 - connectors, 25
 - description, 10
 - hardware installation procedure, 19
 - inspection procedure, 11
 - LEDs, 11
 - pinout, 26
 - specifications, 27
 - supported features, 10
 - unpacking information, 11

B

- Broadcast Unknown Server (BUS)
 - definition, 16

C

- cables
 - optical, 25
- Cautions
 - IP addresses on separate subnetwork, 13
 - LEC on separate network, 40, 41
 - use of anti-static grounding strap, 19
- cell frame type, 30
- commands, decdiag
 - atm_external, 23
 - help, 22

- sar_mem_e, 23
- selftest, 22, 23
- configuration
 - subnet mask, 13

D

- decdiag command, 21
- decdiag utility, 29
- diagnostics, 29
 - LED status on ATMworks 350L, 11
 - testing ATMworks 350L functionality, 21
- dust protecting caps, 25

E

- empty cell type, 30
- End Station Identifier (ESI)
 - definition, 31
- extinction ratio
 - PCI, 27

F

- fiber specifications
 - PCI, 27
- frequency
 - PCI, 27

H

- hardware overview, 10

I

- idle cells, 30
- installation

- memory required, 29
- processor required, 29
- IP addresses, 40
 - assigning, 40, 41
 - viewing, 40
- IP netmask
 - assigning, 39, 41
 - description, 13
- ipconfig command
 - listing IP addresses, 40

L

- LAN Emulation (LANE)
 - components, 15
 - definition, 14
- LAN Emulation Client (LEC)
 - definition, 16
- LAN Emulation Configuration Server (LECS)
 - definition, 16
- LAN Emulation Server (LES)
 - definition, 16
- launched power
 - PCI, 27
- loopback cable
 - use in ATMworks 350L testing, 23

M

- Media Access Control (MAC) layer, 14

N

- netmask
 - description, 13

O

- operating temperature
 - PCI, 27, 28
- optical cables
 - connecting to ATMworks 350L, 25
 - protecting, 25

P

- PCI
 - BIOS Setup, 29
 - extinction ratio, 27
 - fiber specifications, 27
 - frequency, 27, 28
 - mean launched power, 27
 - operating temperature, 27, 28
 - power requirements, 27, 28
 - sensitivity, 27
- pinout diagram, 26
- Port Configuration
 - cell frame type, 30
 - empty cell type, 30
 - slot number, 30
 - UNI version, 30
- power requirements
 - PCI, 27, 28
- procedures
 - ATMworks 350L inspection, 11
 - ATMworks 350L installation, 19
 - initial test of ATMworks 350L functionality, 21

R

- related documents, 9
- RJ45
 - connector, 26
 - jack, 26

S

- SC connectors
 - duplex, 25
 - simplex, 25
- SDH, configuring, 30
- sensitivity
 - PCI, 27
- slot number, 30
- software installation
 - memory requirements, 29
 - processor requirements, 29
- SONET, configuring, 30

subnet mask
 definition, 13
 examples, 14
systems supported, 29

U

unassigned cells, 30
UNI version, 30
UNIX commands
 decdiag, 21

W

"well-known" ATM address, 32

