



# DWZZH 16-Bit UltraSCSI Hub

---

## User's Guide

EK-DWZZH-UG. D01

---

**Fourth Edition, November 1998**

While Compaq Computer Corporation believes the information included in this manual is correct as of the date of publication, it is subject to change without notice. Compaq makes no representations that the interconnection of its products in the manner described in this document will not infringe existing or future patent rights, nor do the descriptions contained in this document imply the granting of licenses to make, use, or sell equipment or software in accordance with the description. No responsibility is assumed for the use or reliability of firmware on equipment not supplied by Compaq or its affiliated companies. Possession, use, or copying of the software or firmware described in this documentation is authorized only pursuant to a valid written license from Compaq, an authorized sublicensor, or the identified licensor.

Commercial Computer Software, Computer Software Documentation and Technical Data for Commercial Items are licensed to the U.S. Government with Compaq's standard commercial license and, when applicable, the rights in DFAR 252.227 7015, "Technical Data-Commercial Items."

© 1998 Compaq Computer Corporation.  
All rights reserved. Printed in U.S.A.

Compaq, the Compaq logo, DIGITAL, DIGITAL UNIX, DECconnect, HSZ, HSG, StorageWorks, VMS, OpenVMS Registered in the United States Patent and Trademark Office.

UNIX is a registered trademark in the United States and other countries exclusively through X/Open Company Ltd. Windows NT is a registered trademark of the Microsoft Corporation. Sun is a registered trademark of Sun Microsystems, Inc. Hewlett-Packard, TACHYON, and HP-UX are registered trademarks of the Hewlett-Packard Company. IBM and AIX are registered trademarks of International Business Machines Corporation. All other trademarks and registered trademarks are the property of their respective owners.

This equipment has been tested and found to comply with the limits for a Class A digital device, pursuant to Part 15 of the FCC Rules. These limits are designed to provide reasonable protection against harmful interference when the equipment is operated in a commercial environment. This equipment generates, uses and can radiate radio frequency energy and, if not installed and used in accordance with the manuals, may cause harmful interference to radio communications. Operation of this equipment in a residential area is likely to cause harmful interference in which case the user will be required to correct the interference at his own expense. Restrictions apply to the use of the local-connection port on this series of controllers; failure to observe these restrictions may result in harmful interference. Always disconnect this port as soon as possible after completing the setup operation. Any changes or modifications made to this equipment may void the user's authority to operate the equipment.

**Warning!**

This is a Class A product. In a domestic environment this product may cause radio interference in which case the user may be required to take adequate measures.

**Achtung!**

Dieses ist ein Gerät der Funkstörgrenzwertklasse A. In Wohnbereichen können bei Betrieb dieses Gerätes Rundfunkstörungen auftreten, in welchen Fällen der Benutzer für entsprechende Gegenmaßnahmen verantwortlich ist.

**Attention!**

Ceci est un produit de Classe A. Dans un environnement domestique, ce produit risque de créer des interférences radioélectriques, il appartiendra alors à l'utilisateur de prendre les mesures spécifiques appropriées.

**JAPAN**

この装置は、情報処理装置等電波障害自主規制協議会（VCCI）の基準に基づくクラスA情報技術装置です。この装置を家庭環境で使用すると電波妨害を引き起こすことがあります。この場合には使用者が適切な対策を講ずるよう要求されることがあります。

**USA**

This equipment generates, uses, and may emit radio frequency energy. The equipment has been type tested and found to comply with the limits for a Class A digital device pursuant to Part 15 of FCC rules, which are designed to provide reasonable protection against such radio frequency interference. Operation of this equipment in a residential area may cause interference in which case the user at his own expense will be required to take whatever measures may be required to correct the interference. Any modifications to this device - unless expressly approved by the manufacturer - can void the user's authority to operate this equipment under part 15 of the FCC rules.



# Contents

---

<b>Revision Record</b> .....	vii
<b>About This Guide</b> .....	ix
<b>1 Introducing the DWZZH UltraSCSI Hub</b>	
1.1 UltraSCSI Hub Functions .....	1-1
1.2 Product Descriptions.....	1-2
1.2.1 DWZZH 3.5" SBB Hubs .....	1-2
1.2.2 DWZZH 5.25" SBB Hubs .....	1-4
1.2.3 SCSI Bus Components.....	1-4
1.3 Product Specifications .....	1-5
<b>2 Using the DWZZH UltraSCSI Hub</b>	
2.1 Large Hub Fair Arbitration .....	2-1
2.2 Large Hub Addressing Configurations .....	2-2
2.3 Narrow Addressing Setting .....	2-3
2.4 Front Panel .....	2-6
2.4.1 Fair Arb Disable .....	2-6
2.4.2 Indicators.....	2-7
2.5 Determining the Configuration.....	2-7
2.6 Selecting the SCSI Cables.....	2-7
2.7 Placement of UltraSCSI Hubs.....	2-7
<b>3 SWCC and UltraSCSI Hubs</b> .....	3-1
<b>Glossary</b>	
<b>Figures</b>	
1-1 DWZZH-21 or DWZZH-03 3.5" SBB Hub.....	1-2
1-2 DWZZH-21 Front Panel.....	1-3
1-3 DWZZH-03 Front Panel.....	1-3
1-4 DWZZH-05 5.25" SBB Hub.....	1-4
2-1 DWZZH-05 SCSI ID Assignments .....	2-3
2-2 DWZZH-05 SCSI Narrow ID Assignments .....	2-4
2-3 DWZZH-05 SCSI Narrow Addressing Jumper .....	2-5
2-4 DWZZH-05 SCSI Front Panel.....	2-6

**Figures (Cont'd)**

3-1 Running One SWCC Agent for a Particular Storage Subsystem ..... 3-3

**Tables**

1-1 DWZZH Hub Functional Specifications..... 1-5  
2-1 Combinations of UltraSCSI Hubs and Devices in StorageWorks Shelves ..... 2-8

## *Revision Record*

---

*The Revision Record provides a concise publication history of this guide. It lists the guide revision levels and release dates, and summarizes the changes.*

---

The following revision history lists all revisions of this publication and their effective dates. The publication part number is included in the Revision Level column, with the last entry denoting the latest revision. This publication supports the DWZZH 16-Bit UltraSCSI Hub.

<b>Revision Level</b>	<b>Date</b>	<b>Summary of Changes</b>
EK-DWZZH-UG. A01	October 1997	Original Release.
EK-DWZZH-UG. B01	April 1998	Change title page; Add Section 1.2.2 describing DWZZH-05 Hub; Change Chapter 2 title from “Installing” to “Using” and add procedures for configuring a SCSI bus using a DWZZH hub.
EK-DWZZH-UG. C01	July 1998	Change “SCSI” to “UltraSCSI” throughout; Add documents to list of Related Documents; Modify Figure 1-3; Add installation recommendation in introduction to Chapter 2; Add Section 2.6, <i>Placement of UltraSCSI Hubs</i> . Add Chapter 3, <i>SWCC and UltraSCSI Hubs</i> ; Add Glossary entries.

EK-DWZZH-UG. D01	October 1998	Change Section 2.1, add CAUTION after Section 2.1. Make minor changes to Section 2.3.3; renumber Section 2.3.3 as Section 2.3. Renumber Sections 2.3, 2.4, 2.5, and 2.6 as 2.4, 2.5, 2.6, and 2.7, respectively.
------------------	--------------	--



## *About This Guide*

---

*This chapter tells you what this User's Guide does, identifies the audience, describes the structure and contents (chapter-by-chapter) briefly, and tells you how to get support and services from Compaq.*

---

This User's Guide describes the purpose, function, operation, and use of the DWZZH UltraSCSI Hub (the DWZZH Hub or the Hub). The DWZZH Hub allows the connection of up to five ports on one logical SCSI bus.

### **Visit our Web Site for the Latest Information**

Check our web site for the latest drivers, technical tips, and documentation. We can be found in the technical area of our web page:

*<http://www.storage.digital.com/>*

### **Audience**

This guide is intended for end users and for Compaq employees responsible for configuring, installing, and maintaining the StorageWorks subsystem and its components.

### **Related Documentation**

You should be familiar with the information contained in the following documentation:

<b>Document Title</b>	<b>Order Number</b>
<i>StorageWorks Solutions Configuration Guide</i>	EK-BA350-CG
<i>StorageWorks Solutions Shelf and SBB User's Guide</i>	EK-BA350-UG
<i>StorageWorks SBB Shelf I/O Modules</i>	EK-SBBIO-UG
<i>StorageWorks UltraSCSI Configuration Guidelines</i>	EK-ULTRA-CG
<i>StorageWorks Solutions BA356-SB 16-bit Shelf User's Guide</i>	EK-BA356-UG
<i>Shared Storage Solutions Using UltraSCSI Hubs</i>	EK-SMA21-AN
<i>Shared Storage for Windows NT Using UltraSCSI Hubs</i>	EK-SMA17-AN
<i>Shared Storage for DIGITAL OpenVMS Using UltraSCSI Hubs</i>	EK-SMA19-AN
<i>Shared Storage for DIGITAL UNIX Using UltraSCSI Hubs</i>	EK-SMA20-AN

## Document Structure

This guide contains the following chapters:

### **Chapter 1. Introducing the DWZZH UltraSCSI Hub**

This chapter gives brief functional and physical descriptions of the DWZZH Hub and lists significant product specifications.

### **Chapter 2. Using the DWZZH UltraSCSI Hub**

This chapter gives the procedures for configuring a StorageWorks SCSI bus using a DWZZH Hub.

### **Chapter 3. SWCC and UltraSCSI Hubs**

This chapter provides important information concerning the use of StorageWorks Command Console (SWCC) on SCSI buses that have an UltraSCSI hub. While the information provided here is important, it is essential that you have read the SWCC manual and release notes.

### **Glossary**

The Glossary defines terms that are used frequently with StorageWorks and SCSI bus components.

## Support and Services

### **Who to contact in the Americas**

---

**Information and Product Questions:** Local Sales Office / StorageWorks Hotline  
1-800-786-7967

**Installation Support:** Contact the Compaq Distributor where the Storage Solution was Purchased / Local Compaq Sales Office.

#### **Compaq Multivendor Customer Service (MCS)**

**Installation** Contact the Compaq Customer Support Center (CSC).

**Warranty** Contact the Compaq Customer Support Center (CSC) for warranty service after solution is installed and operating.

**Remedial** Contact the Compaq Customer Support Center (CSC)

**Note:** A Service Contract is recommended when the equipment is out of warranty. Contact the local Compaq Sales Office.

---

**Customer Support Center (CSC)** 1 800-354-9000

---

### **Who to contact in Europe**

---

<b>Information and Product Questions, Installation Support, and Installation:</b>	Contact the Compaq Distributor or reseller from whom the Storage Solution was purchased.
<b>For Warranty Service</b>	See the Warranty Card packaged with the product.
<b>For Remedial Service</b>	Contact the Compaq Distributor or reseller from whom the Storage Solution was purchased. <b>Note:</b> A Service Contract is recommended when the equipment is out of warranty.

---

### **Who to contact in Asia Pacific**

---

For all services, contact the Compaq Distributor or reseller from whom the equipment was purchased.



# 1

## *Introducing the DWZZH UltraSCSI Hub*

---

*This chapter describes the DWZZH Hub functions and available versions, and list the Hub functional specifications.*

---

The series of DWZZH Hubs are SCSI-2 and draft SCSI-3 (ANSI X379.2/91-10R3) compliant 16-bit converters capable of data transfer rates of up to 40 Mbytes per second. The series of Hubs consists of the following:

- DWZZH-21 and DWZZH-03 are 3.5" SBB (small) Hubs; the DWZZH-21 contains two single-ended and one differential UltraSCSI ports, while the DWZZH-03 contains three differential UltraSCSI ports.
- DWZZH-05 is a 5.25" SBB (large) Hub that contains 5 differential UltraSCSI ports.

### **1.1 UltraSCSI Hub Functions**

Most device SCSI buses are either 8-bit or 16-bit single-ended, physical buses. Some controllers and hosts use differential buses and others use a single-ended bus. Single-ended and differential physical buses are not compatible. The SCSI protocol disables both buses when they are connected together. However, by using an UltraSCSI Hub you can accomplish the following:

- Connect a differential physical bus to a single-ended physical bus (DWZZH-21 UltraSCSI Hub only).
- Extend the maximum length of a SCSI bus.
- Provide radial disconnect where remaining connections can continue to operate.
- Provide "fair" SCSI arbitration for host nodes (DWZZH-05 UltraSCSI HUB only).

## 1.2 Product Descriptions

There are two classes of DWZZH Hubs: 3.5" SBB Hubs, and 5.25" SBB Hubs.

### 1.2.1 DWZZH 3.5" SBB Hubs

The DWZZH small UltraSCSI Hub (Figure 1-1) comes in two versions.

- DWZZH-21 contains two single-ended UltraSCSI connectors and one differential UltraSCSI connector; Figure 1-2 illustrates the front panel.
- DWZZH-03 contains three differential UltraSCSI connectors; Figure 1-3 illustrates the front panel.

**CAUTION**

Connecting a differential bus cable to the single-ended connector, or a single-ended bus cable to the differential connector causes the SCSI bus to fail.

**Figure 1-1 DWZZH-21 or DWZZH-03 3.5" SBB Hub**

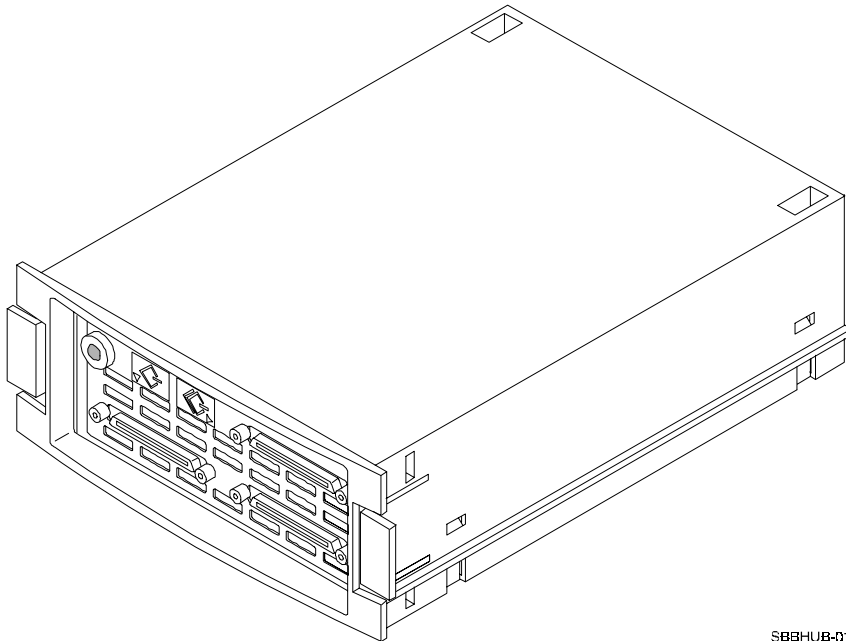

SBBHUB-01

Figure 1-2 DWZZH-21 Front Panel

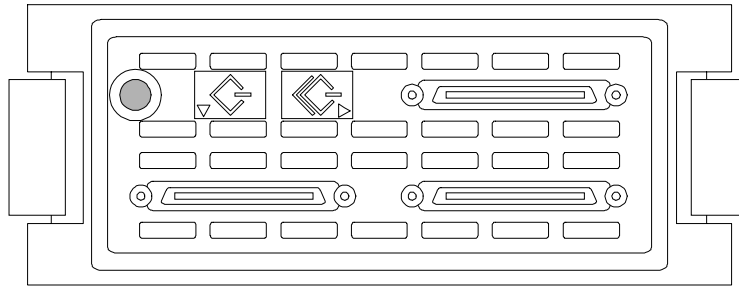

SBBHUB-02

**NOTE**

The single-ended symbol with the downward-pointing diamond in Figure 1-2 indicates that the lower two connectors are single-ended UltraSCSI connections, while the differential symbol with the right-pointing diamond indicates that the top connector is a differential UltraSCSI connector.

Figure 1-3 DWZZH-03 Front Panel

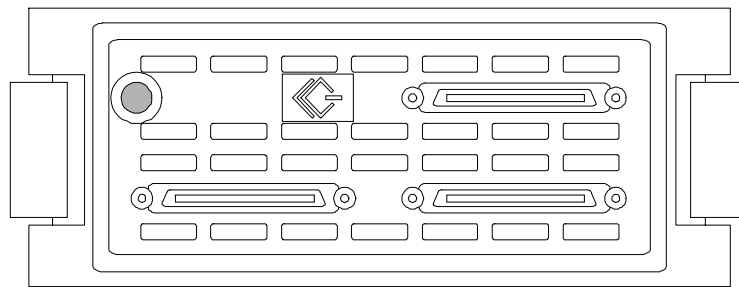

SBBHUB-03

**NOTE**

The differential symbol in Figure 1-3 indicates that the three connectors are differential UltraSCSI connectors.

### 1.2.2 DWZZH 5.25" SBB Hubs

The DWZZH large UltraSCSI Hub (Figure 1-4) comes in a single version that contains five differential UltraSCSI bus connectors.

**CAUTION**

Connecting a single-ended bus cable to **any** differential connector causes the SCSI bus to fail.

**Figure 1-4 DWZZH-05 5.25" SBB Hub**

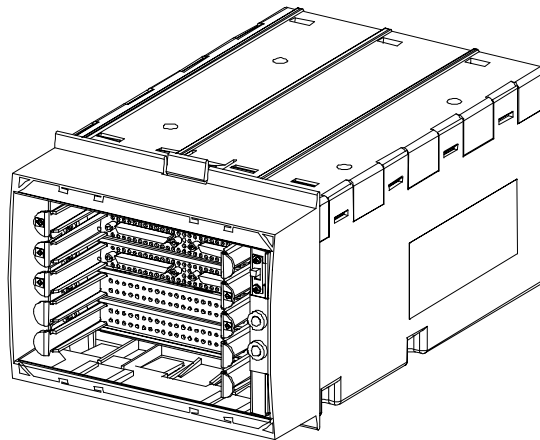

### 1.2.3 SCSI Bus Components

To install a DWZZH UltraSCSI Hub you will need BN37A and BN38C series SCSI cables. Refer to the *StorageWorks UltraSCSI Configuration Guidelines*, EK-ULTRA-CG, for a complete list of the available cables.



### 1.3 Product Specifications

Table 1-1 lists the functional specifications for the DWZZH Hub.

**Table 1–1 DWZZH Hub Functional Specifications**

<b>Feature</b>	<b>Specification</b>
SCSI ID SCSI Addresses	The small UltraSCSI HUB does not use a SCSI ID. The large UltraSCSI HUB uses SCSI ID 7 for arbitration.
Overload Protection DTERMPPOWER STERMPPOWER	TERMPPOWER is not supplied to the external ports of the UltraSCSI HUB. Internal TERMPPOWER is protected via a resettable fuse. TERMPPOWER must be supplied from the remote connection to enable each HUB port.
Shielding Enclosure & Connectors	Shielded for ESD, EMI, and safety requirements
Power-Up Reset	Automatically clears <ul style="list-style-type: none"> <li>• Initiator detection circuit</li> <li>• Target detection circuit</li> <li>• BSY glitch filter</li> </ul>
SCSI Bus Reset	Automatically clears <ul style="list-style-type: none"> <li>• Initiator detection circuit</li> <li>• Target detection circuit</li> <li>• BSY glitch filter</li> </ul>
Single-Ended SCSI Bus Length Ultra (20 megatransfers per second or 40 MB/s)	20 meters (66 feet) per segment
Differential SCSI Bus Length	25 meters (82 feet) per segment
Data Timing	The relationship between the data and the control signals is brought to SCSI compatibility before transmission to the other SCSI bus.
Design	High reliability SMT

**Table 1–1 DWZZH Hub Functional Specifications (Cont'd)**

<b>Feature</b>	<b>Specification</b>
Cable Fault	DIFFSENSE support and port disable on cable fault
Glitch Elimination	100% glitch free operation during power-up BUSY GLITCH trap eliminates cable length constraint due to wired-OR glitches on the BSY line
<b>Termination</b>	
Singled-ended	Active termination for 16bit operation.
Differential	Termination for 16bit operation.
Service There are no user servicable functions on these products. Contact Digital service personnel all service.	
Agency Approvals UL, CSA, FCC Class B, TUV	
<b>Environmental Specifications</b>	
Relative Humidity	10% to 85% non-condensing
Operating Temperature	10°C to 40°C (50°F to 104°F)
Storage Temperature (non-operating)	–40°C to 66°C (–40°F to 151°F)
<b>Power Requirements</b>	
DWZZH	+5V
Input Current:	
DWZZH-03	2.3 Amp
DWZZH-05	4.3 Amp
DWZZH-21	1.8 Amp
TERMPower	Supplied to internal terminators only.
<b>SCSI Connectors and Cables</b>	
Single-Ended	Board mounted 68pin VHDCI SCSI connector
Differential	Board mounted 68pin VHDCI SCSI connector
Cables	BN37A and BN38C series shielded SCSI cables

# 2

## *Using the DWZZH UltraSCSI Hub*

---

*This chapter discusses fair arbitration of the SCSI bus by the 5.25" SBB Hub, describes addressing configurations, tells you how to use the large Hub front panel, and gives guidelines for selecting the SCSI cables.*

---

UltraSCSI Configuration guidelines are documented in EK-ULTRA-CG. These guidelines include a list of all UltraSCSI components and the last few example configurations include an UltraSCSI Hub. Refer to the configuration guidelines for bus length and SCSI bus data transmission rates.

The UltraSCSI Hubs are designed to be installed in a StorageWorks Solutions BA356 Shelf or in a StorageWorks BA370 shelf. The small UltraSCSI Hub can be installed in any open SBB slot. The large UltraSCSI Hub can be installed in any slots that will accommodate a 5.25" SBB. When installing UltraSCSI Hubs in a BA370 shelf, it is recommended that UltraSCSI Hubs be installed in the lower right hand device slots of the shelf, to allow better clearance for hot-swapping of disk drives installed in the BA370 shelf. The small UltraSCSI Hub does not consume a SCSI ID and uses the shelf only to provide its power and mechanical support. The large UltraSCSI Hub uses SCSI ID 7 to control the fair arbitration of the host port IDs and uses the shelf only to provide its power and mechanical support.

### **2.1 Large Hub Fair Arbitration**

The large Hub configurations utilize a modified SCSI arbitration algorithm. The normal SCSI arbitration scheme is based on the SCSI ID. The highest priority SCSI ID will always win arbitration. This could have the effect of 'starving' lower priority SCSI ID requests on the bus.

SCSI ID 7 is RESERVED and may not be assigned to any SCSI device connected to the UltraSCSI Hub, whether FairARB is enabled or disabled. In order to allow up to four 'host' SCSI IDs to participate on a single SCSI bus, a fair arbitration (fair arb) scheme is employed. Fair arb works by assigning SCSI ID 7, the highest priority ID, to the Hub. When a SCSI arbitration phase occurs, all the arbitrating IDs are captured in a register. The winning ID for this group will be the highest priority ID. After this ID has been serviced, the ID will be

removed from the group and at the next arbitration phase, the remaining highest ID will be serviced. This will continue until all of the IDs in the group have been serviced once. All requests from IDs not contained in the register will be “backed off ” using ID 7.

**CAUTION**

Most manufacturers ship host bus adapters with a default SCSI ID of 7. Ensure that the ID is changed BEFORE you establish a connection between the adapter and the Hub.

After all the IDs in the group have been serviced, a new group of IDs will be captured at the next arbitration phase. The fair arbitration algorithm only applies to host port SCSI IDs as defined by the assignment in each configuration.

**CAUTION**

Running the UltraSCSI Hub under heavy I/O with Fair Arbitration disabled might result in SCSI Bus starvation for hosts with lower SCSI IDs.

## 2.2 Large Hub Addressing Configurations

The large UltraSCSI Hub has a specific SCSI ID configuration. The SCSI IDs are assigned to specific physical locations in the Hub. This allows the fair arbitration logic in the Hub to correctly identify the SCSI IDs that are participating in a fair arbitration cycle.

**CAUTION**

The SCSI ID of each host adapter must correspond to the assigned SCSI ID of the host port to which the host adapter is connected. Mismatched SCSI IDs will cause the SCSI bus to hang.

Figure 2-1 shows the physical layout of the ports and their associated SCSI ID assignments.

Figure 2-1 DWZZH-05 SCSI ID Assignments

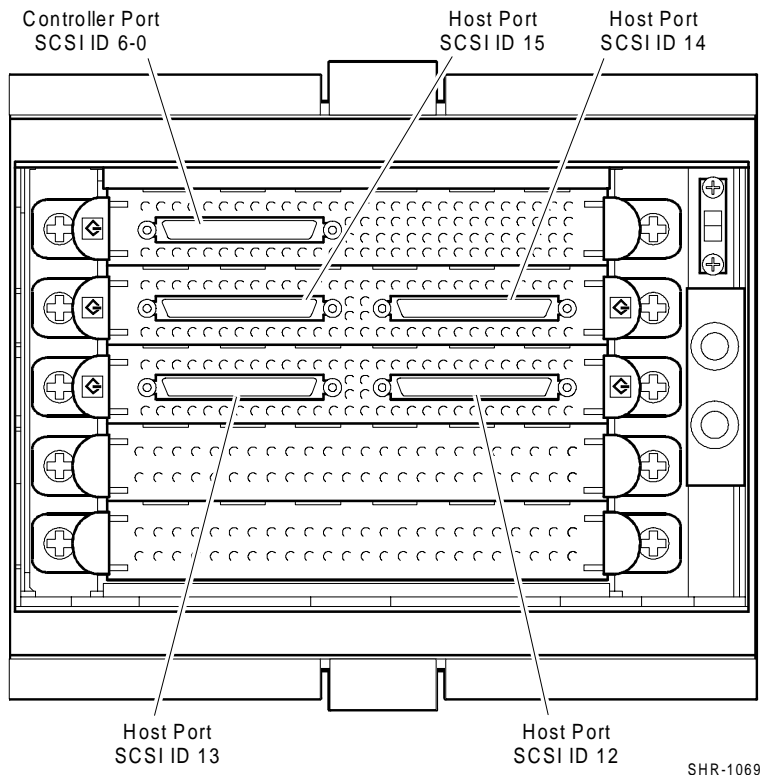

### 2.3 Narrow Addressing Setting

The large Hub can be used with SCSI bus architectures that are limited to eight ID assignments, such as DIGITAL UNIX 4.x and earlier versions. (Figure 2-2 shows narrow ID assignments). The jumper on the rear of the Hub (Figure 2-3) must be closed to make the Hub respond to SCSI IDs 3 – 0 on the host ports.

**Figure 2-2 DWZZH-05 SCSI Narrow ID Assignments**

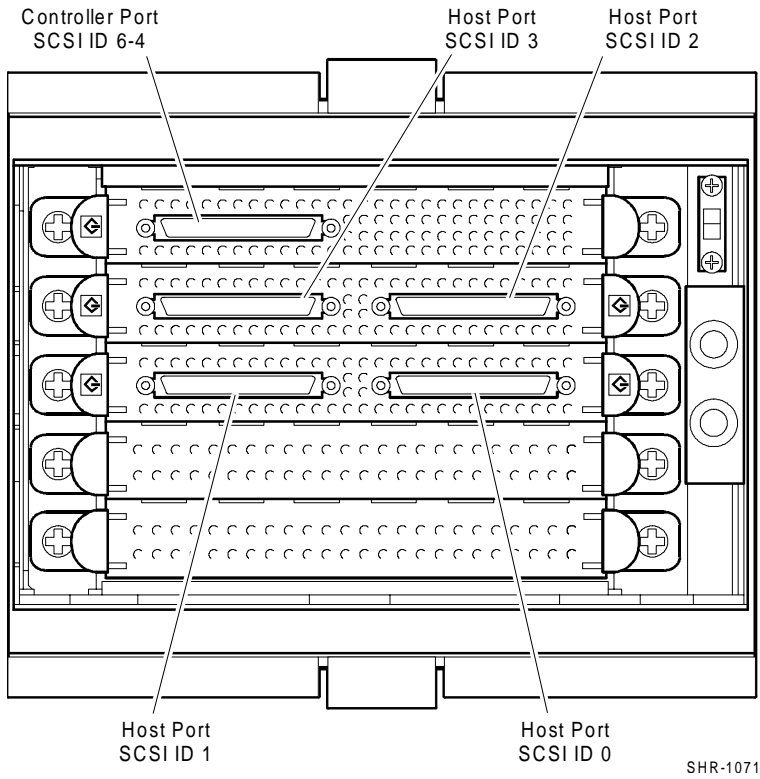

**Figure 2-3 DWZZH-05 SCSI Narrow Addressing Jumper**

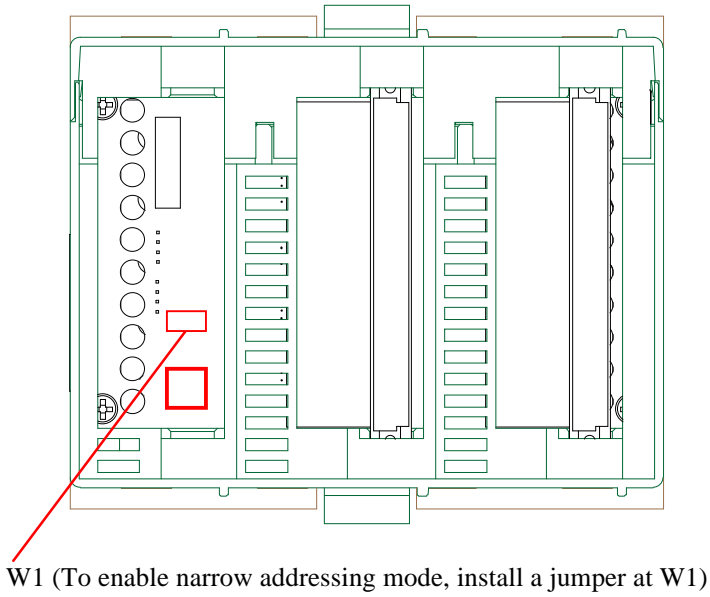

W1 (To enable narrow addressing mode, install a jumper at W1)

## 2.4 Front Panel

Figure 2-4 shows the location of the front panel controls and indicators.

Figure 2-4 DWZZH-05 Front Panel

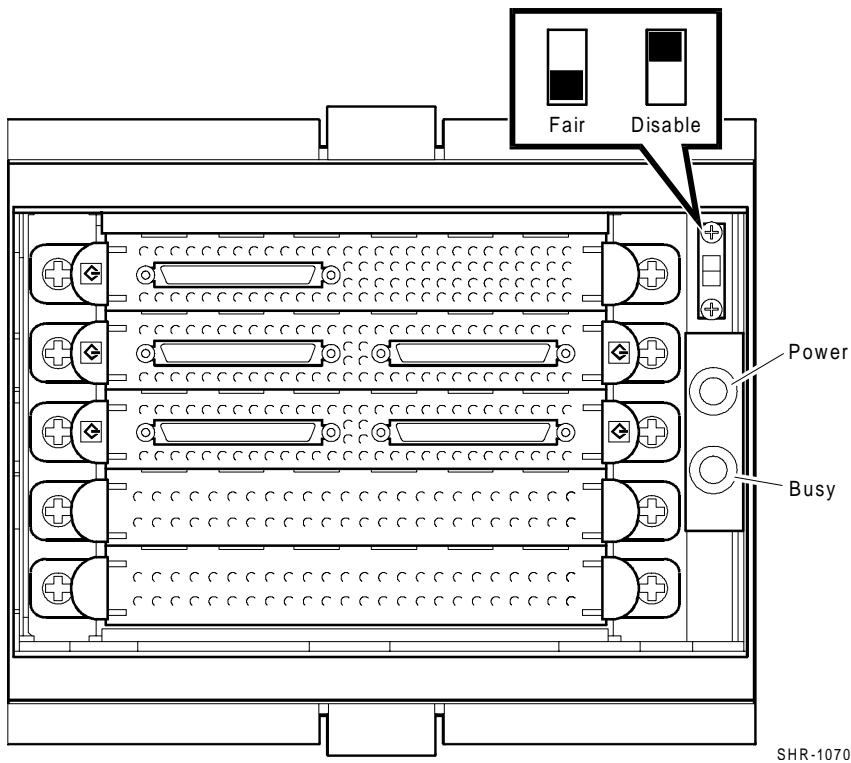

### NOTE

The black part of the switch in the diagram indicates the position of the switch.

#### 2.4.1 Fair Arb Disable

The large Hub contains a switch on the front panel that allows the user to disable the *FAIR ARB* feature of the Hub. When *FAIR ARB* is disabled, the Hub services SCSI arbitration cycles in the conventional SCSI priority order. Host port SCSI ID assignments are not linked to the physical port location in the Hub when *FAIR ARB* is disabled.



### **2.4.2 Indicators**

The large Hub has two indicators on the front panel. The green LED indicates that POWER is applied to the Hub, while the yellow LED indicates that the SCSI bus is BUSY.

## **2.5 Determining the Configuration**

The UltraSCSI Hub is used in end-bus SCSI bus configurations only. The SCSI bus segments require TERMPOWER supplied from the remote connection to enable the UltraSCSI Hub port for that segment. Each port on the UltraSCSI Hub has its own terminators.

All SCSI buses are terminated at the physical ends of the bus. This is true even when using a DWZZH UltraSCSI Hub. DWZZH UltraSCSI Hubs are factory set to terminate the SCSI bus. No user configuration of the SCSI terminators is required.

## **2.6 Selecting the SCSI Cables**

The *StorageWorks UltraSCSI Configuration Guidelines*, EK-ULTRA-CG, describes SCSI cables in detail. When selecting a cable you must consider the cable connector clearance. Be sure to determine the type connector compatible with the controller connector. In some cases you must use a right-angle connector because there is not enough clearance to use a straight connector. Cables connected to the DWZZH UltraSCSI Hubs are BN37A and BN38C series.

## **2.7 Placement of UltraSCSI Hubs**

UltraSCSI Hubs are available only in SBBs and may be used only within a BA356 StorageWorks shelf or a BA370 StorageWorks shelf. The StorageWorks shelves are only used to provide power and cooling for UltraSCSI Hubs. An UltraSCSI Hub and I/O devices may share the same storage shelf.

Maximum combinations of UltraSCSI Hubs and disk drives within a single shelf and with dual power supplies are listed in Table 2-1.

**Table 2-1 Combinations of UltraSCSI Hubs and Devices in StorageWorks Shelves**

<b>Number of Small Hubs (DWZZH-03/-21)</b>	<b>Number of Large Hubs (DWZZH-05)</b>	<b>Number of Disk Drives</b>	<b>Personality Module</b>
5	0	0	Not installed
4	0	0	Installed
3	0	3	Installed
2	0	4	Installed
1	0	5	Installed
0	2	0	Not installed
3	1	0	Not installed
2	1	1	Installed
1	1	2	Installed
0	1	3	Installed

# 3

## *SWCC and UltraSCSI Hubs*

---

*This chapter is intended to provide you with important information regarding the use of StorageWorks Command Console on SCSI buses that have an UltraSCSI Hub. While the information provided here is important, it is essential that you have read the SWCC Manual and Release Notes.*

---

### **3.1 Agents and Storage**

It is highly recommended that you only run *one* SWCC agent on *one* of the servers that can access a particular storage subsystem behind the DS-DWZZH-05 UltraSCSI Hub. Using SWCC through the client-agent model is very similar to using a serial terminal to access the HSZ70 controller; running multiple agents to access one storage subsystem would show up as multiple storage windows on the SWCC-Client machine. This could be a potential problem, as the Client would see multiple HSZ70 subsystems, when in fact, only one exists, but is being displayed multiple times.

#### **NOTE**

If you have multiple storage subsystems behind the DWZZH UltraSCSI Hub, be sure to name each of your storage subsystems uniquely and carefully (when you configure SWCC) so that you can distinguish between them easily.

The SWCC Graphical User Interface (GUI) neither displays when HSZ access ID restriction is being enforced nor prevents changes to restricted configurations from the GUI. For example, consider having four servers, each with a uniquely identified Host Bus Adapter attached to a DWZZH 5-port UltraSCSI Hub, connected to an RA7000 subsystem (Figure 3-1). Furthermore, consider the case where you have access ID restrictions configured such that each SCSI ID 12-15 could access a unique set of six disks in the storage cabinet.

This type of configuration would prevent systems with different SCSI IDs from accessing disks *'belonging to'* a particular SCSI ID, which promotes data security between servers on a shared SCSI bus; however, it *does not* prevent SWCC from performing tasks on those disks. In other words, if you set up the SWCC client to have configuration capability (see SWCC documentation) then you can access everything in the storage subsystem, regardless of HSZ70 access ID restrictions.

For further information on setting up and configuring agents on HSZ controllers, please see the SWCC and controller documentation.

Figure 3-1 Running One SWCC Agent for a Particular Storage Subsystem

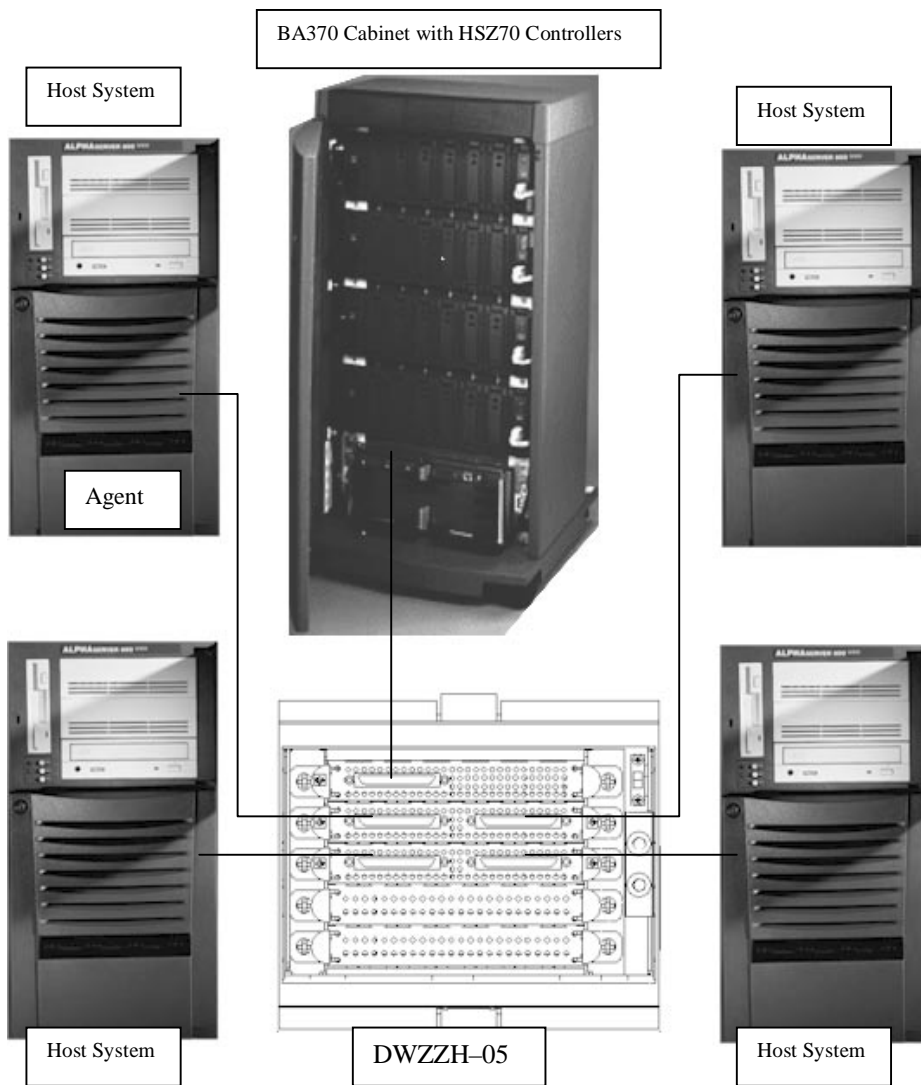



## *Glossary*

---

*This Glossary includes an alphabetized listing and brief definition of the abbreviations, acronyms, Compaq-specific references, and other technical terms that are used in this manual and that may be unfamiliar to the reader.*

---

### **adapter**

*See* SCSI bus converter.

### **building block shelf**

*See* SBB shelf.

### **controller**

A hardware/firmware device that manages communications on behalf of host systems over the SCSI bus to devices, such as the HSC-series, HSJ-series, and HSZ-series controllers. Controllers typically differ by the type of interface to the host and provide functions beyond what the devices support.

### **differential SCSI bus**

A signal's level is determined by the potential difference between two wires. A differential bus is more robust and less subject to electrical noise than is a single-ended bus.

### **DWZZC**

A StorageWorks compatible 16-bit UltraSCSI bus converter.

*See* **SCSI bus converter**.

### **DWZZH**

A StorageWorks compatible 16-bit UltraSCSI bus HUB.

### **electrostatic discharge**

*See* **ESD**.

### **ESD**

Electrostatic discharge is the discharge of a potentially harmful static electric voltage as a result of improper grounding.

### **host**

The primary or controlling computer or any such unit (in a multiple computer network) to which storage is attached.

**host adapter**

A device that connects the host system I/O bus (for example, a PCI bus) to the storage SCSI bus. A host adapter performs the lower layers of the SCSI protocol and normally operates in the initiator role.

**initiator**

A SCSI device that requests another device on the bus to perform an operation. Any device on the bus can be an initiator or a target.

**logical bus**

A single-ended, or differential, physical bus connected to a differential, physical bus by a SCSI bus converter.

**personality module**

The BA356 module that interfaces the SCSI-bus to the BA356 shelf.

**physical bus**

Two SCSI terminators separated by cables, connectors, and/or the backplane circuitry.

**SBB**

StorageWorks building block. The basic building block of the StorageWorks product line. Any device conforming to shelf mechanical and electrical standards installed in either a 3½-inch or 5¼-inch carrier is considered to be an SBB, whether it is a storage device, a power supply, or other device.

**SBB shelf**

The common name for any StorageWorks shelf that contains only power supply and storage SBBs.

**SCSI**

Small Computer System Interface. This ANSI interface defines the physical and electrical parameters of a parallel I/O bus used to connect computers and devices. The StorageWorks subsystem implementation uses SCSI–2 or SCSI–3 for the transfer of data.

**SCSI bus converter**

Sometimes referred to as an adapter. (1) A connecting device that permits the attachment of accessories or provides the capability to mount or link units. (2) The device that connects a differential SCSI bus to a single-ended SCSI bus.

**SCSI device**

A host computer adapter, a peripheral controller, or an intelligent peripheral that can be attached to the SCSI bus.

**SCSI device ID**

The bit-significant, representation of the SCSI addressing referring to one of the signal lines numbered 0 through 15. Also referred to as target ID. For example, SCSI device ID 1 would be represented as 00001.



**SCSI end-bus position**

The physical location of a controller or a device that contains the SCSI bus termination.

**SCSI mid-bus position**

The physical location of a controller or a device that the SCSI bus passes through enroute to the controller or device that contains the SCSI bus termination.

**SCSI cable**

A 68-conductor (34 twisted pairs) cable used for differential bus connections.

**single-ended SCSI bus**

A bus in which each signal's logic level is determined by the voltage of a single wire in relation to ground.

**Small Computer System Interface**

*See* SCSI.

**StorageWorks**

The Digital set of enclosure products that allows customers to design and configure their own storage subsystem. Components include power, packaging, and interconnections in a StorageWorks shelf. SBBs and array controllers are integrated therein to form level enclosures to house the shelves. Standard mounting devices for SBBs are also included.

**StorageWorks building block**

*See* SBB.

**target**

A SCSI device that performs an operation requested by an initiator. Any device on the bus can be an initiator or a target.

**target ID**

*See* SCSI device ID.

**terminators**

The interconnect components that form the ends of the transmission lines in bus segments. A SCSI domain must have at least one segment and therefore at least two terminators. The terminators ensure that inactive SCSI bus signals are in a known state. There are two basic types of terminators - active and passive.

- Single-ended bus segments use active, linear terminators.
- Differential bus segments use passive (linear totem pole) terminators.

*except* for special cases where the electrical transmission lines are very short and only one termination or pull-up is required.

**termpower**

An electrical current that is limited by self-resetting fuses.

**UltraSCSI**

An improvement in SCSI technology invented in 1993 by the Compaq Computer Corporation StorageWorks Engineering Group. Subsequently the ANSI SCSI Standards Committee issued standard X3T10 for UltraSCSI. The UltraSCSI improvements over Fast SCSI include the following:

- Maximum transfer rate increases from 10 MHz to 20 MHz.

**VHDCI**

Very High Density Cable Interconnect