

**digital**

**DIGITAL GIGAswitch/Router**

---

**Getting Started Guide**



# **DIGITAL GIGAswitch/Router**

---

## **Getting Started Guide**

Part Number: 9032681-02

**December 1998**

This manual describes how to install and set up the DIGITAL GIGAswitch/Router.

**Revision/Update Information:** This is a revised document.

## Notice

Cabletron Systems reserves the right to make changes in specifications and other information contained in this document without prior notice. The reader should in all cases consult Cabletron Systems to determine whether any such changes have been made.

The hardware, firmware, or software described in this manual is subject to change without notice.

IN NO EVENT SHALL CABLETRON SYSTEMS BE LIABLE FOR ANY INCIDENTAL, INDIRECT, SPECIAL, OR CONSEQUENTIAL DAMAGES WHATSOEVER (INCLUDING BUT NOT LIMITED TO LOST PROFITS) ARISING OUT OF OR RELATED TO THIS MANUAL OR THE INFORMATION CONTAINED IN IT, EVEN IF CABLETRON SYSTEMS HAS BEEN ADVISED OF, KNOWN, OR SHOULD HAVE KNOWN, THE POSSIBILITY OF SUCH DAMAGES.

© Cabletron Systems, Inc., 1998.

All Rights Reserved  
Printed in the United States of America

**Cabletron Systems** and **SPECTRUM** are registered trademarks and **Cabletron**, **clearVISN**, and **GIGAswitch** are trademarks of Cabletron Systems, Inc.

DEC, DIGITAL, and the DIGITAL logo are trademarks of Digital Equipment Corporation.

Java and Solaris are trademarks of Sun Microsystems, Inc.

Netscape Navigator is a registered trademark of Netscape Communications Corp.

Pentium is a registered trademark of Intel Corp.

Windows NT is a trademark and Microsoft, Windows, and Windows 95, are registered trademarks of Microsoft Corp.

HP is a registered trademark and OpenView is a trademark of Hewlett Packard Company.

UNIX is a registered trademark of The Open Group in the US and other countries.

All other product names mentioned in this manual may be trademarks or registered trademarks of their respective companies.

## FCC Notice — Class A Computing Device

This equipment generates, uses, and may emit radio frequency energy. The equipment has been type tested and found to comply with the limits for a Class A digital device pursuant to Part 15 of FCC rules, which are designed to provide reasonable protection against such radio frequency interference. Operation of this equipment in a residential area may cause interference in which case the user at his own expense will be required to take whatever measures may be required to correct the interference. Any modifications to this device - unless expressly approved by the manufacturer - can void the user's authority to operate this equipment under part 15 of the FCC rules.

## Industry Canada Notice

This digital apparatus does not exceed the Class A limits for radio noise emissions from digital apparatus set out in the Radio Interference Regulations of the Canadian Department of Communications.

Le présent appareil numérique n'émet pas de bruits radioélectriques dépassant les limites applicables aux appareils numériques de la class A prescrites dans le Règlement sur le brouillage radioélectrique édicté par le ministère des Communications du Canada.

## VCCI Notice — Class A Computing Device

This equipment is a Class A product (information equipment to be used in commercial and/or industrial areas) and conforms to the standards set by the Voluntary Control Council for Interference by Data Processing Equipment and Electronic Office Machines aimed at preventing radio interference in commercial and/or industrial areas. Consequently, when used in a residential area or in an adjacent area thereto, radio interference may be caused to radios and TV receivers. Read the instructions for correct handling.

この装置は、情報処理装置等電波障害自主規制協議会（VCCI）の基準に基づくクラスA情報技術装置です。この装置を家庭環境で使用すると電波妨害を引き起こすことがあります。この場合には使用者が適切な対策を講ずるよう要求されることがあります。

**Taiwanese Notice — Class A Computing Device:**

**警告使用者:**

這是甲類的資訊產品，在居住的環境中使用時，可能會造成射頻干擾，在這種情況下，使用者會被要求採取某些適當的對策。

## CE Notice — Class A Computing Device

### Warning!

This is a Class A product. In a domestic environment, this product may cause radio interference, in which case the user may be required to take adequate measures.

### Achtung!

Dieses ist ein Gerät der Funkstörgrenzwertklasse A. In Wohnbereichen können bei Betrieb dieses Gerätes Rundfunkstörungen auftreten, in welchen Fällen der Benutzer für entsprechende Gegenmaßnahmen verantwortlich ist.

### Avertissement!

Cet appareil est un appareil de Classe A. Dans un environnement résidentiel cet appareil peut provoquer des brouillages radioélectriques. Dans ce cas, il peut être demandé à l'utilisateur de prendre les mesures appropriées.

## Cabletron Systems, Inc. Program License Agreement

**IMPORTANT:** Before utilizing this product, carefully read this License Agreement.

This document is an agreement between you, the end user, and Cabletron Systems, Inc. ("Cabletron") that sets forth your rights and obligations with respect to the Cabletron software program (the "Program") contained in this package. The Program may be contained in firmware, chips or other media. BY UTILIZING THE ENCLOSED PRODUCT, YOU ARE AGREEING TO BECOME BOUND BY THE TERMS OF THIS AGREEMENT, WHICH INCLUDES THE LICENSE AND THE LIMITATION OF WARRANTY AND DISCLAIMER OF LIABILITY. IF YOU DO NOT AGREE TO THE TERMS OF THIS AGREEMENT, PROMPTLY RETURN THE UNUSED PRODUCT TO THE PLACE OF PURCHASE FOR A FULL REFUND.

### Cabletron Software Program License

1. **LICENSE.** You have the right to use only the one (1) copy of the Program provided in this package subject to the terms and conditions of this License Agreement.

You may not copy, reproduce or transmit any part of the Program except as permitted by the Copyright Act of the United States or as authorized in writing by Cabletron.

2. **OTHER RESTRICTIONS.** You may not reverse engineer, decompile, or disassemble the Program.
3. **APPLICABLE LAW.** This License Agreement shall be interpreted and governed under the laws and in the state and federal courts of New Hampshire. You accept the personal jurisdiction and venue of the New Hampshire courts.

## Exclusion of Warranty and Disclaimer of Liability

1. **EXCLUSION OF WARRANTY.** Except as may be specifically provided by Cabletron in writing, Cabletron makes no warranty, expressed or implied, concerning the Program (including its documentation and media).

CABLETRON DISCLAIMS ALL WARRANTIES, OTHER THAN THOSE SUPPLIED TO YOU BY CABLETRON IN WRITING, EITHER EXPRESSED OR IMPLIED, INCLUDING BUT NOT LIMITED TO IMPLIED WARRANTIES OF MERCHANTABILITY AND FITNESS FOR A PARTICULAR PURPOSE, WITH RESPECT TO THE PROGRAM, THE ACCOMPANYING WRITTEN MATERIALS, AND ANY ACCOMPANYING HARDWARE.

2. **NO LIABILITY FOR CONSEQUENTIAL DAMAGES.** IN NO EVENT SHALL CABLETRON OR ITS SUPPLIERS BE LIABLE FOR ANY DAMAGES WHATSOEVER (INCLUDING, WITHOUT LIMITATION, DAMAGES FOR LOSS OF BUSINESS, PROFITS, BUSINESS INTERRUPTION, LOSS OF BUSINESS INFORMATION, SPECIAL, INCIDENTAL, CONSEQUENTIAL, OR RELIANCE DAMAGES, OR OTHER LOSS) ARISING OUT OF THE USE OR INABILITY TO USE THIS CABLETRON PRODUCT, EVEN IF CABLETRON HAS BEEN ADVISED OF THE POSSIBILITY OF SUCH DAMAGES. BECAUSE SOME STATES DO NOT ALLOW THE EXCLUSION OR LIMITATION OF LIABILITY FOR CONSEQUENTIAL OR INCIDENTAL DAMAGES, OR ON THE DURATION OR LIMITATION OF IMPLIED WARRANTIES, IN SOME INSTANCES THE ABOVE LIMITATIONS AND EXCLUSIONS MAY NOT APPLY TO YOU.

## United States Government Restricted Rights

The enclosed product (a) was developed solely at private expense; (b) contains "restricted computer software" submitted with restricted rights in accordance with Section 52227-19 (a) through (d) of the Commercial Computer Software - Restricted Rights Clause and its successors, and (c) in all respects is proprietary data belonging to Cabletron and/or its suppliers.

For Department of Defense units, the product is licensed with "Restricted Rights" as defined in the DoD Supplement to the Federal Acquisition Regulations, Section 52.227-7013 (c) (1) (ii) and its successors, and use, duplication, disclosure by the Government is subject to restrictions as set forth in subparagraph (c) (1) (ii) of the Rights in Technical Data and Computer Software clause at 252.227-7013. Cabletron Systems, Inc., 35 Industrial Way, Rochester, New Hampshire 03867-0505.

# SAFETY INFORMATION

## CLASS 1 LASER TRANSCEIVERS

The DGSRF-AA 100Base-FX Module, DGSRS-AA 1000BASE-SX Module, and DGSRL-AA 1000BASE-LX Module use Class 1 Laser transceivers. Read the following safety information before installing or operating these modules.

The Class 1 laser transceivers use an optical feedback loop to maintain Class 1 operation limits. This control loop eliminates the need for maintenance checks or adjustments. The output is factory set, and does not allow any user adjustment. Class 1 Laser transceivers comply with the following safety standards:

- 21 CFR 1040.10 and 1040.11 U.S. Department of Health and Human Services (FDA).
- IEC Publication 825 (International Electrotechnical Commission).
- CENELEC EN 60825 (European Committee for Electrotechnical Standardization).

When operating within their performance limitations, laser transceiver output meets the Class 1 accessible emission limit of all three standards. Class 1 levels of laser radiation are not considered hazardous.

### Laser Radiation and Connectors

When the connector is in place, all laser radiation remains within the fiber. The maximum amount of radiant power exiting the fiber (under normal conditions) is -12.6 dBm or  $55 \times 10^{-6}$  watts.

Removing the optical connector from the transceiver allows laser radiation to emit directly from the optical port. The maximum radiance from the optical port (under worst case conditions) is  $0.8 \text{ W cm}^{-2}$  or  $8 \times 10^3 \text{ W m}^2 \text{ sr}^{-1}$ .

**Do not use optical instruments to view the laser output. The use of optical instruments to view laser output increases eye hazard. When viewing the output optical port, power must be removed from the network adapter.**



## DECLARATION OF CONFORMITY ADDENDUM

Application of Council Directive(s):	<b>89/336/EEC 73/23/EEC</b>
Manufacturer's Name:	<b>Cabletron Systems, Inc.</b>
Manufacturer's Address:	<b>35 Industrial Way PO Box 5005 Rochester, NH 03867</b>
European Representative Name:	<b>Mr. J. Solari</b>
European Representative Address:	<b>Cabletron Systems Limited Nexus House, Newbury Business Park London Road, Newbury Berkshire RG13 2PZ, England</b>
Conformance to Directive(s)/Product Standards:	<b>EC Directive 89/336/EEC EC Directive 73/23/EEC EN 55022 EN 50082-1 EN 60950</b>
Equipment Type/Environment:	<b>Networking Equipment, for use in a Commercial or Light Industrial Environment.</b>

We the undersigned, hereby declare, under our sole responsibility, that the equipment packaged with this notice conforms to the above directives.

Manufacturer	Legal Representative in Europe
Mr. Ronald Fotino	Mr. J. Solari
Full Name	Full Name
Principal Compliance Engineer	Managing Director - E.M.E.A.
Title	Title
Rochester, NH, USA	Newbury, Berkshire, England
Location	Location



# Contents

<b>About This Guide</b> .....	<b>xi</b>
Who Should Read This Guide? .....	xi
How to Use This Guide .....	xi
Related Documentation.....	xii
Correspondence.....	xii
Getting Help.....	xiii
<b>Safety</b> .....	<b>xv</b>
Overview .....	xv
Safety Requirements .....	xvi
<b>Chapter 1: Features Overview</b> .....	<b>1</b>
Specifications .....	1
Features.....	4
Hardware Overview .....	8
<b>Chapter 2: Hardware Installation</b> .....	<b>25</b>
Safety Considerations .....	25
Hardware Specifications .....	26
Installing the Hardware .....	27
<b>Chapter 3: Software Installation and Setup</b> .....	<b>45</b>
Installing a PCMCIA Flash Card .....	45
Powering On and Booting the Software .....	47
Starting the Command Line Interface .....	47
Setting Basic System Information .....	49
Setting Up SNMP Community Strings .....	52
Setting Up Passwords.....	54
Setting the DNS Domain Name and Address.....	55
Setting the SYSLOG Parameters .....	57
Loading System Image Software .....	59
Loading Boot PROM Software .....	60
Activating Configuration Changes and Saving the Configuration File.....	61

<b>Chapter 4: Installing and Starting DIGITAL clearVISN CoreWatch.....</b>	<b>65</b>
What Is DIGITAL clearVISN CoreWatch?.....	65
System Requirements .....	66
Installing DIGITAL clearVISN CoreWatch .....	66
Starting DIGITAL clearVISN CoreWatch.....	68
<b>Appendix A: Troubleshooting.....</b>	<b>71</b>
<b>Index .....</b>	<b>75</b>

# About This Guide

This guide provides a general overview of the 8-slot and 16-slot DIGITAL GIGAswitch/Router (GSR-8 and GSR-16) hardware and software features. It provides procedures for installing the GSR-8 and GSR-16 and setting them up for management using DIGITAL clearVISN CoreWatch Element Management software. For product information not available in this guide, see the manuals listed in “Related Documentation” on page xii.

## Who Should Read This Guide?

Read this guide if you are a network administrator responsible for installing and setting up the GSR-8 or GSR-16.

**Note:** Only qualified personnel should perform the installation procedures in this guide.

## How to Use This Guide

If You Want To...	See...
Get an overview of the GSR-8 and GSR-16 software and hardware features	Chapter 1, “Features Overview” on page 1
Install the GSR-8 or GSR-16 hardware	Chapter 2, “Hardware Installation” on page 25
Install the GSR-8 or GSR-16 software, boot the software, and set up the unit	Chapter 3, “Software Installation and Setup” on page 45
Set up the GSR-8 or GSR-16 for management using clearVISN CoreWatch	Chapter 4, “Installing and Starting DIGITAL clearVISN CoreWatch” on page 65

If You Want To...	See...
Contact DIGITAL for technical support	"Correspondence" on page xii and "Getting Help" on page xiii,
Troubleshoot installation problems	Appendix A, "Troubleshooting" on page 71

## Related Documentation

The DIGITAL documentation set includes the following items. Refer to these other documents to learn more about your product.

For Information About...	See the...
Managing the GSR-8 or GSR-16 using the clearVISN CoreWatch Element Management application	<i>DIGITAL clearVISN CoreWatch User's Guide</i> and the clearVISN CoreWatch online help
How to use Command Line Interface (CLI) commands to configure and manage the GSR-8 or GSR-16	<i>DIGITAL GIGAswitch/Router User Reference Manual</i>
The complete syntax for all CLI commands	<i>DIGITAL GIGAswitch/Router Command Line Interface Reference Manual</i>
SYSLOG messages	<i>DIGITAL GIGAswitch/Router Error Reference Manual</i>

## Correspondence

### Documentation Comments

If you have comments or suggestions about this manual, send them to DIGITAL Network Products Organization.

Attn.:Documentation Project Manager  
E-MAIL: [doc\\_quality@lkg.mts.dec.com](mailto:doc_quality@lkg.mts.dec.com)

## Online Services

To locate product-specific information, refer to the DIGITAL Network Products Home Page on the World Wide Web located at the following addresses:

<b>Americas:</b>	<a href="http://www.networks.digital.com">http://www.networks.digital.com</a>
<b>Europe:</b>	<a href="http://www.networks.europe.digital.com">http://www.networks.europe.digital.com</a>
<b>Asia Pacific:</b>	<a href="http://www.networks.digital.com.au">http://www.networks.digital.com.au</a>

## Getting Help

To expedite your inquiry when you contact your DIGITAL representative, please provide the following information:

- Your Name
- Your Company Name
- Address
- Email Address
- Phone Number
- FAX Number
- Detailed description of the issue (including history, what you've tried, and conditions under which you see this occur)
- Hardware module number, software version, and switch configuration (that is, what part types are in what slots)







# Safety

## Overview

Any warning or caution that appears in this manual is defined as follows:

	WARNING	Warns against an action that could result in equipment damage, personal injury, or death.
	VORSICHT	Warnt den Benutzer vor Aktionen, die das Gerät beschädigen, Personen verletzen oder sogar zum Tod führen könnten.
	DANGER	Déconseille à l'utilisateur d'exécuter une action pouvant entraîner des dommages matériels, corporels voire la mort.
	AVISO	Previene contra una acción que podría dañar el equipo, provocar daños personales o la muerte.
	CAUTION	Contains information essential to avoid damage to the equipment.
	ACHTUNG	Liefert wichtige Informationen, um einen Geräteschaden zu vermeiden.
	ATTENTION	Informations indispensables permettant d'éviter les dommages matériels.
	PRECAUCIÓN	Contiene información esencial para evitar daños al equipo.

## Safety Requirements

The warnings or cautions that must be observed for the hardware described in this manual are listed below in English, German, French, and Spanish:

### Warnings

---

WARNING	Do not use optical instruments to view the laser output. The use of optical instruments to view laser output increases eye hazard. When viewing the output optical port, power must be removed from the network adapter.
VORSICHT	Zum Ansehen der Laserausgabe dürfen keine optischen Geräte benutzt werden, da dadurch das Risiko von Augenverletzungen erhöht wird. Vor dem Ansehen des optischen Ausgangsanschlusses muß der Netzwerkadapter vom Stromanschluß getrennt werden.
DANGER	N'utilisez pas d'instruments d'optique pour voir la sortie du laser. Leur usage augmente les risques de lésions oculaires. Lorsque vous voyez le port optique de la sortie, vous devez couper l'alimentation de l'adaptateur de réseau.
AVISO	No utilice instrumentos ópticos para ver la salida de láser. El uso de instrumentos ópticos para ver una salida de láser incrementa los daños en los ojos. Al ver el puerto óptico de salida, se debe retirar la alimentación del adaptador de red.

---

**WARNING** To prevent personal injury, follow these safety precautions when installing and using the GIGAswitch/Router.

- To avoid back strain, be careful when lifting the chassis out of the shipping box.
- Never attempt to rack mount the GIGAswitch/Router chassis unaided. Ask an assistant to help you hold the chassis.
- Never operate the GIGAswitch/Router with exposed power-supply bays or module slots. You can leave the PCMCIA slots exposed but make sure you do not place any tools or body parts in the PCMCIA slot.
- Never operate the GIGAswitch/Router if the chassis becomes wet or the area where the chassis is installed is wet.

**VORSICHT** Beachten Sie bei der Installation und Verwendung von GIGAswitch/Router die folgenden Sicherheitsbestimmungen, um Verletzungen zu vermeiden.

- Seien Sie beim Herausheben des Gehäuses aus der Verpackung vorsichtig, um Rückenschmerzen zu vermeiden.
- Bauen Sie das Gehäuse des GIGAswitch/Router nicht ohne Hilfe anderer ein. Bitten Sie jemanden, Ihnen beim Halten des Gehäuses zu helfen.
- Betreiben Sie den GIGAswitch/Router nie mit geöffneten Netzteilabteilen oder Modulsteckplätzen. Sie können die PCMCIA-Steckplätze offen lassen. Achten Sie aber darauf, keine Gegenstände in die PCMCIA-Steckplätze einzuführen, und greifen Sie nicht in die Steckplätze hinein.
- Betreiben Sie den GIGAswitch/Router nicht, wenn das Gehäuse oder die Umgebung feucht sind.

---

DANGER Pour éviter tout dommage corporel, suivez les consignes de sécurité lorsque vous installez et que vous utilisez le GIGAswitch/Router.

- Soyez prudent lorsque vous soulevez le boîtier pour le retirer de son emballage, faute de quoi vous risquez de vous faire mal au dos.
- Ne tentez pas d'installer le boîtier du GIGAswitch/Router sans aide. Faites-vous aider par quelqu'un et demandez-lui de vous tenir le boîtier.
- N'utilisez pas le GIGAswitch/Router lorsque les compartiments d'alimentation électrique ou les logements pour modules sont exposés. Les emplacements pour cartes PCMCIA peuvent être exposés, mais veillez à ne pas y insérer d'outils et ni mettez pas vos doigts.
- Vous ne devez en aucun cas utiliser le GIGAswitch/Router si le boîtier ou l'endroit dans lequel il est stocké est mouillé.

AVISO Para evitar daños personales, siga las normas de seguridad siguientes cuando instale o utilice GIGAswitch/Router.

- Para evitar daños en la espalda, extreme las precauciones cuando extraiga la carcasa de su embalaje.
  - Nunca intente montar en bastidor la carcasa del GIGAswitch/Router sin ayuda. Pida a alguien que le ayude a sujetar la carcasa.
  - Nunca ponga en funcionamiento el GIGAswitch/Router con módulos o ranuras de módulos expuestos a una fuente de alimentación. Puede dejar las ranuras de PCMCIA expuestas aunque debe asegurarse de no colocar ningún objeto o parte del cuerpo en dichas ranuras.
  - Nunca ponga en funcionamiento el GIGAswitch/Router si la carcasa o el área donde se ha instalado se encuentra húmeda.
-

---

WARNING	To avoid back strain, be careful when lifting the chassis out of the shipping box.
VORSICHT	Seien Sie bei Herausheben des Gehäuses aus der Verpackung vorsichtig, um Rückenprobleme zu vermeiden.
DANGER	Soyez prudent lorsque vous soulevez le boîtier pour le retirer de son emballage, faute de quoi vous risquez de vous faire mal au dos.
AVISO	Para evitar daños en la espalda, extreme las precauciones cuando extraiga la carcasa de su embalaje.

---

---

WARNING	The GIGAswitch/Router supports hot swapping. This means you can remove and insert line cards while the GIGAswitch/Router is operating. However, you cannot insert tools or body parts inside the chassis while it is powered on. Doing so can cause electrical shock or equipment damage.
VORSICHT	Der GIGAswitch/Router unterstützt Auswechseln von Modulen während des Betriebs. Allerdings dürfen Sie keine Gegenstände ins Gerät einführen oder ins Gerät greifen, solange es eingeschaltet ist. Sie könnten einen elektrischen Schlag erhalten oder zumindest das Gerät beschädigen.
DANGER	Le GIGAswitch/Router permet les branchements à chaud. Vous pouvez donc retirer et insérer des cartes lorsque le GIGAswitch/Router est activé. Toutefois, ne touchez pas le boîtier avec des outils ou avec vos doigts lorsqu'il est sous tension. Dans le cas contraire, vous risquez de provoquer un court-circuit ou d'endommager votre matériel.
AVISO	GIGAswitch/Router soporta el intercambio de conexión sin interrupción del funcionamiento. Esto significa que puede retirar e insertar tarjetas de línea mientras GIGAswitch/Router está funcionando. Sin embargo, no inserte ninguna herramienta o parte del cuerpo dentro de la carcasa cuando ésta esté conectada a la alimentación. Podría tener como consecuencia una descarga eléctrica o daños en el equipo.

---

## Cautions

---

CAUTION	To ensure that the fan module can provide adequate cooling, always provide at least 3 inches of clearance around the top and bottom of the chassis.
ACHTUNG	Um sicherzustellen, daß das Ventilatormodul ausreichende Kühlung bietet, sollten oberhalb und unterhalb des Gehäuses stets 3 Zoll Mindestabstand eingehalten werden.
ATTENTION	Pour que le module de ventilation fonctionne correctement, vous devez dégager les côtés du boîtier.
PRECAUCIÓN	Para asegurarse de que el módulo del ventilador puede facilitar la refrigeración adecuada, deje siempre al menos 7,5 centímetros (3 pulgadas) de espacio libre alrededor de la parte superior e inferior del chasis.

---

- 
- CAUTION To prevent accidental product damage, observe the following precautions:
- Always use proper electrostatic discharge (ESD) gear when handling the Control Module, backplane, line modules or other internal parts of the chassis.
  - Make sure you allow adequate room for air flow around the chassis.
  - If you plan to install the chassis in an equipment rack, it is recommended that you install a support tray under the chassis, especially for chassis that are completely filled (no empty Control Module, power supply, or line card slots).
- ACHTUNG Beachten Sie folgende Hinweise, um Beschädigungen des Produkts zu vermeiden:
- Verwenden Sie beim Umgang mit dem Steuerungsmodul, dem rückwärtigen Einbaukäfig, den Leitungsanschlußmodulen und anderen internen Geräteteilen stets eine geeignete Antistatikausrüstung.
  - Lassen Sie um das Gehäuse genügend Abstand für ausreichende Luftzirkulation.
  - Wenn Sie das Gehäuse in einem Rack installieren, wird empfohlen, unter dem Gerät eine Halteplatte zu installieren, insbesondere, wenn das Gehäuse keine leeren Abteile enthält (Steuerungsmodule, Netzteile und Anschlußkarten alle eingebaut).
- ATTENTION Suivez les instructions ci-après pour éviter d'endommager l'appareil :
- Veillez à toujours utiliser la fonction antistatique lorsque vous manipulez le module de contrôle, la partie arrière, les modules de connexion ou autres parties internes.
  - Assurez-vous qu'il y a suffisamment de place autour du boîtier et qu'il est correctement ventilé.
  - Si vous souhaitez installer le boîtier dans un autre module, nous vous conseillons d'installer un support sous le boîtier, surtout s'il est complètement plein (avec le module de contrôle, l'alimentation et toutes les cartes).



---

**PRECAUCIÓN** Para evitar daños accidentales del producto, siga las precauciones que se muestran a continuación:

- Utilice siempre un dispositivo de descarga electrostática (ESD) adecuado cuando manipule el módulo de control, panel posterior, línea de módulos u otras partes internas de la carcasa.
  - Asegúrese de que haya espacio suficiente para un correcto flujo de aire alrededor de la carcasa.
  - Si piensa instalar la carcasa en un bastidor, se recomienda instalar una bandeja de soporte bajo la carcasa, especialmente para aquellas carcasas totalmente completas (ningún módulo de control, fuente de alimentación o ranuras de tarjeta de línea vacíos).
-

---

CAUTION	To make lifting and holding the chassis easier, install the chassis before you install line cards or redundant Control Modules and power supplies.
ACHTUNG	Zur Erleichterung beim Hochheben oder Festhalten des Gehäuses sollten Sie das Gehäuse vor den herausnehmbaren Karten oder redundanten Steuermodulen und Netzanschlußgeräten installieren.
ATTENTION	Pour faciliter la manutention du boîtier, installez-le avant d'insérer les cartes extractibles ou les modules de contrôle et les sources d'alimentation auxiliaires.
PRECAUCIÓN	Para poder levantar y sostener el chasis con más facilidad, instale el chasis antes que las tarjetas de línea o los módulos de control redundantes y fuentes de alimentación.

---

---

CAUTION	Make sure the screws are tight before your assistant releases the chassis. If you accidentally leave the screws loose, the chassis can slip and fall, possibly becoming damaged.
ACHTUNG	Achten Sie darauf, daß die Schrauben fest angezogen sind, ehe Ihr Helfer das Gehäuse losläßt. Wenn Sie die Schrauben versehentlich nicht fest anziehen, kann das Gehäuse verrutschen und fallen und dabei beschädigt werden.
ATTENTION	Assurez-vous que les vis sont serrées avant que la personne qui vous aide ne lâche le boîtier. Si elles ne sont pas correctement serrées, le boîtier risque de glisser, de tomber et de s'abîmer.
PRECAUCIÓN	Asegúrese de que los tornillos estén bien apretados antes de que la persona que le ayuda suelte la carcasa. Si, accidentalmente, los tornillos no se encuentran lo suficientemente apretados, la carcasa podría soltarse y caerse, lo cual podría causar daños en la misma.

---

---

CAUTION	Test all the new passwords before saving the active configuration to the Startup configuration file. The passwords are shown in the active configuration in an encrypted format and will also appear this way in the Startup configuration.
ACHTUNG	Testen Sie allen neuen Kennwörter, ehe Sie die aktive Konfiguration in der Systemstart-Konfigurationsdatei speichern. Wie im Beispiel oben gezeigt, erscheinen die Kennwörter in der aktiven Konfiguration verschlüsselt. Dies gilt auch für die Systemstart-Konfiguration.
ATTENTION	Vérifiez tous les nouveaux mots de passe avant d'enregistrer la configuration active dans le fichier de configuration. Dans l'exemple ci-dessous, les mots de passe apparaissent dans la configuration active dans un format codé et il figureront également sous cette forme dans le fichier de configuration.
PRECAUCIÓN	Verifique todas las contraseñas nuevas antes de guardar la configuración activa en el archivo de configuración de inicio. Como se muestra en el ejemplo anterior, las contraseñas aparecen en la configuración activa en un formato codificado y también aparecerán de este modo en la configuración de inicio.

---

---

CAUTION	The active configuration remains in effect only during the current power cycle. If you power down or reboot the GIGAswitch/Router without saving the active configuration changes to the Startup configuration file, the changes are lost.
ACHTUNG	Die aktive Konfiguration bleibt nur wirksam, solange das Gerät nicht ausgeschaltet wird. Wenn Sie den GIGAswitch/Router ausschalten, ohne die Änderungen der aktiven Konfiguration in der Systemstart-Konfigurationsdatei zu speichern, gehen die Änderungen verloren.
ATTENTION	La configuration ne reste active que pendant le cycle de mise sous tension. Si vous mettez le GIGAswitch/Router hors tension ou si vous le redémarrez sans enregistrer la configuration active dans le fichier de configuration, les modifications ne sont pas prises en compte.
PRECAUCIÓN	La configuración activa tiene efecto sólo durante el ciclo de alimentación actual. Si hay un corte en el suministro de alimentación o se reinicia el GIGAswitch/Router sin guardar la configuración activa, se cambiará el archivo de configuración de inicio y se perderán los cambios.

---

# Chapter 1

## Features Overview

The 8- and 16-slot DIGITAL GIGAswitch/Routers (GSR-8 and GSR-16) provide non-blocking, wire-speed Layer-2 (switching), Layer-3 (routing) and Layer-4 (application) switching. This chapter provides a basic overview of the GSR software and hardware feature set.

- If you want to skip this information and install the GSR now, see Chapter 2, “Hardware Installation” on page 25.
- If you want to boot the GSR software and perform basic configuration tasks now, see Chapter 3, “Software Installation and Setup” on page 45.
- If you want to set up a management station for using DIGITAL clearVISN CoreWatch, see Chapter 4, “Installing and Starting DIGITAL clearVISN CoreWatch” on page 65.

### Specifications

The GSR provides wire-speed switching and full non-blocking throughput. The hardware provides wire-speed performance regardless of the performance monitoring, filtering, and Quality of Service (QoS) features enabled by the software. You do not need to accept performance compromises to run QoS or access control lists (ACLs).

The following table lists the basic hardware and software specifications for the GSR.

Feature	Specification
Throughput	<ul style="list-style-type: none"> <li>• 16-Gbps non-blocking switching fabric (GSR-8)</li> <li>• 32-Gbps non-blocking switching fabric (GSR-16)</li> <li>• Up to 15 million packets-per-second routing throughput (GSR-8)</li> <li>• Up to 30 million packets-per-second routing throughput (GSR-16)</li> </ul>
Capacity	<ul style="list-style-type: none"> <li>• Up to 250,000 routes</li> <li>• Up to 2,000,000 Layer-4 application flows (GSR-8)</li> <li>• Up to 4,000,000 Layer-4 application flows (GSR-16)</li> <li>• 400,000 Layer-2 MAC addresses (GSR-8)</li> <li>• 800,000 Layer-2 MAC addresses (GSR-16)</li> <li>• 4,096 Virtual LANs (VLANs)</li> <li>• 20,000 Layer-2 security and access-control filters</li> <li>• 3 MB input/output buffering per Gigabit port</li> <li>• 1 MB input/output buffering per 10/100 port</li> </ul>
Routing protocols	<ul style="list-style-type: none"> <li>• IP: RIP v1/v2, OSPF, BGP 2, 3 ,4</li> <li>• IPX: RIP, SAP</li> <li>• Multicast: IGMP, DVMRP</li> </ul>
Bridging and VLAN protocols	<ul style="list-style-type: none"> <li>• 802.1d Spanning Tree</li> <li>• 802.1Q (VLAN trunking)</li> </ul>
Media Interface protocols	<ul style="list-style-type: none"> <li>• 802.3 (10Base-T)</li> <li>• 802.3u (100Base-TX, 100Base-FX)</li> <li>• 802.3x (1000Base-SX, 1000Base-LX)</li> <li>• 802.3z (1000Base-SX, 1000Base-LX)</li> </ul>
Quality of Service (QoS)	<ul style="list-style-type: none"> <li>• Layer-2 prioritization (802.1p)</li> <li>• Layer-3 source-destination flows</li> <li>• Layer-4 source-destination flows</li> <li>• Layer-4 application flows</li> </ul>

Feature	Specification
RMON	<ul style="list-style-type: none"> <li>RMON v1/v2 for each port</li> </ul>
Management	<ul style="list-style-type: none"> <li>SNMP</li> <li>clearVISN CoreWatch Element Manager (GUI)</li> <li>Emacs-like Command Line Interface (CLI)</li> </ul>
Port mirroring	<ul style="list-style-type: none"> <li>Traffic to Control Module</li> <li>Traffic from specific ports</li> <li>Traffic to specific chassis slots (line cards)</li> </ul>
Hot swapping	<ul style="list-style-type: none"> <li>Power supply (when redundant supply is installed and online)</li> </ul>
Load balancing/ sharing	<ul style="list-style-type: none"> <li>Cabletron SmartTRUNK support</li> </ul>
Redundancy	<ul style="list-style-type: none"> <li>Redundant and hot-swappable power supplies</li> <li>Virtual Router Redundancy Protocol (VRRP)</li> </ul>

This guide and other GSR documentation refers to the GSR's Layer-2, Layer-3, and Layer-4 switching and routing. These layers are based on the International Standards Organization (ISO) 7-layer reference model. Here is an example of that model. The GSR operates within the layers that are not shaded. Notice that Layer-2 is divided into an LLC layer and a MAC layer. The GSR operates at the MAC layer but not the LLC layer.

Layer 7	Application
Layer 6	Presentation
Layer 5	Session
Layer 4	TCP/UDP - application
Layer 3	IP/IPX - routing
Layer 2	LLC
Layer 2	MAC -bridging
Layer 1	Physical Interfaces

## TCP/UDP Services

The following table lists some well-known TCP/UDP services provided by the GSR.

TCP Port	UDP Port	Description
23		Telnet
	161	SNMP
	67	BOOTP/DHCP Relay Agent
	520	Routed

## Features

This section describes the following GSR features:

- Address-based and flow-based bridging
- Port-based VLANs and protocol-based VLANs
- IP and IPX routing
- Layer-4 (application) switching
- Security
- Quality of Service (QoS)
- Statistics
- Management

## Bridging

The GSR provides the following types of wire-speed bridging:

- **Address-based bridging** – The GSR performs this type of bridging by looking up the destination address in an L2 lookup table on the line card that receives the bridge packet from the network. The L2 lookup table indicates the exit port(s) for the bridged packet. If the packet is addressed to the GSR's own MAC address, the packet is routed rather than bridged.
- **Flow-based bridging** – The GSR performs this type of bridging by looking up an entry in the L2 lookup table containing both the source and destination addresses of the bridge packet.



Your choice of bridging method does not affect GSR performance. However, address-based bridging is more efficient because it requires fewer table entries while flow-based bridging provides tighter management and control over bridged traffic.

The GSR ports perform address-based bridging by default but can be configured to perform flow-based bridging, instead of address-based bridging, on a per-port basis. A port cannot be configured to perform both types of bridging at the same time.

## Port and Protocol VLANs

The GSR supports the following types of Virtual LANs (VLANs):

- **Port-based VLANs** – A port-based VLAN is a set of ports that comprises a Layer-2 broadcast domain. The GSR confines MAC-layer broadcasts to the ports in the VLAN on which the broadcast originates. GSR ports outside the VLAN do not receive the broadcast.
- **Protocol-based VLANs** – A protocol-based VLAN is a named set of ports that comprises an IP or IPX broadcast domain. The GSR confines IP or IPX broadcasts to the ports within the IP or IPX based VLAN. Protocol-based VLANs sometimes are called subnet VLANs or Layer-3 VLANs.

You can include the same port in more than one VLAN, even in both port-based and protocol-based VLANs. Moreover, you can define VLANs that span across multiple GSRs. To simplify VLAN administration, the GSR supports 802.1Q trunk ports, which allow you to use a single port to “trunk” traffic from multiple VLANs to another GSR or switch which supports 802.1Q.

## Routing

The GSR provides wire-speed routing for the following protocols:

- **Internet Protocol (IP)** – IP is the protocol switching and routing devices use for moving traffic within the Internet and within many corporate intranets.
- **Internet Packet Exchange (IPX)** – a protocol by Novell used in Netware products.

**Note:** All other protocols that require routing must be tunneled using IP.

By default, the GSR uses one MAC address for all interfaces. The GSR can be configured to have a separate MAC address for each IP interface and a separate MAC address for each IPX interface. When the GSR receives a packet whose destination MAC address is one of the GSR’s IP or IPX interface MAC addresses, the line card that received the packet from the network uses information in the line card’s L3 lookup tables (or information supplied by the Control Module) to route the packet to its IP destination(s). (See “Control Module” on page 11 for information about the Control Module.)

You can create only one IP and IPX interface on a single port or VLAN. You can add secondary IP addresses to the same IP interface. When you add an interface to a set of

ports, you are adding a VLAN to those ports. Ports that contain IP and IPX interfaces can also still perform Layer-2 bridging.

## IP Routing

The GSR supports the following IP unicast routing protocols:

- RIP v1 and RIP v2
- OSPF v2
- BGP 2,3,4

IP interfaces do not use a specific routing protocol by default. When you configure an interface for routing, you also specify the routing protocol the interface will use.

## IP Multicast Routing

The GSR supports the following IP multicast routing protocols:

- IGMP
- DVMRP

The GSR does not use a specific IP Multicast routing protocol by default. When you configure an interface for IP Multicast, you also specify the routing protocol you want the interface to use.

## IPX Routing

The GSR supports the following IPX routing protocols:

- IPX RIP – a version of the Routing Information Protocol (RIP) tailored for IPX
- IPX SAP – the Service Advertisement Protocol, which allows hosts attached to an IPX network to reach printers, file servers, and other services

By default, IPX routing is enabled on the GSR when an IPX interface is created.

## Layer-4 Switching

In addition to Layer-2 bridging and Layer-3 routing, the GSR performs Layer-4 switching. Layer-4 switching is based on applications and flows.

- **Layer-4 applications** – The GSR understands the application for which an IP or IPX packet contains data and therefore enables you to manage and control traffic on an application basis. For IP traffic, the GSR looks at the packet's TCP or UDP port number

to determine the application. For IPX packets, the GSR looks at the destination socket to determine the application.

- **Layer-4 flows** – The GSR can store Layer-4 flows on each line card. A Layer-4 flow consists of the source and destination addresses in the IP or IPX packet combined with the TCP or UDP source and destination port number (for IP) or the source and destination socket (for IPX). You can therefore manage and control individual flows between hosts – on an individual application basis.

A single host can have many individual Layer-4 entries in the GSR. For example, an IP host might have separate Layer-4 application entries for email, FTP, HTTP, and so on, or separate Layer-4 flow entries for specific email destinations and for specific FTP and Web connections.

## Security

The bridging, routing, and application (Layer-2, Layer-3, and Layer-4) support described in previous sections enables you to implement security filters that meet the specific needs of your organization. You can implement the following types of filters to secure traffic on the GSR.

- Layer-2 source filters (block bridge traffic based on source MAC address)
- Layer-2 destination filters (block bridge traffic based on destination MAC address)
- Layer-2 flow filters (block bridge traffic based on specific source-destination pairs)
- Layer-3 source filters (block IP or IPX traffic based on source IP or IPX address)
- Layer-3 destination filters (block IP or IPX traffic based on destination IP or IPX address)
- Layer-3 flow filters (block IP or IPX traffic based on specific source-destination pairs)
- Layer-4 flow filters (block traffic based on application flows)
- Layer-4 application filters (block traffic based on UDP or TCP source and destination ports for IP or source and destination sockets for IPX)

## Quality of Service

Although the GSR supplies non-blocking wire-speed throughput, you can configure the GSR to apply Quality of Service (QoS) policies during peak periods to guarantee service to specific hosts, applications, and flows (source-destination pairs). This is especially useful in networks where the traffic level can exceed the network medium's capacity.

The GSR QoS is based on four queues: control, high, medium, and low. Control traffic has the highest priority, high the second highest, and so on. The default priority for all traffic is low.

You can configure QoS policies for the following types of traffic:

- Layer-2 prioritization (802.1p)
- Layer-3 source-destination flows
- Layer-4 source-destination flows
- Layer-4 application flows

## Statistics

The GSR can provide extensive statistical data on demand. You can access the following types of statistics:

- Layer-2 RMON and MIB II Statistics – Port statistics for normal packets and for errors (packets in, packets out, CRC errors, and so on)
- Layer-3 RMON v2 Statistics – Statistics for ICMP, IP, IP-interface, IP routing, IP multicast, VLAN
- Layer-4 RMON v2 Statistics – Statistics for TCP and UDP

## Management Platforms

You can manage the GSR using the following management platforms:

- Command Line Interface (CLI) – An emacs editor-like interface that accepts typed commands and responds when applicable with messages or tables. You will use the CLI to perform the basic setup procedures described in Chapter 3 of this guide.
- clearVISN CoreWatch – DIGITAL's Java-based device management software. clearVISN CoreWatch provides a graphical interface to the GSR, providing most of the same monitoring and control features as the CLI.
- SNMP MIBs and traps – The GSR supports SNMP v1 and many standard networking MIBs. You access the GSR's SNMP agent using Cabletron integration software for HP OpenView 5.x on Windows NT or Solaris 2.x, or Cabletron Spectrum on Solaris 2.x. Chapter 3 in this guide explains how to set up SNMP on the GSR. Chapter 4 explains how to access the GSR's SNMP agents.

## Hardware Overview

This section describes the GSR hardware modules with which you will be working. Chapter 2 in this guide describes how to install the hardware. This section describes the following hardware:

- Chassis, Backplane and Fan module

- Control Module
- Power supply
- Switching Fabric Module (GSR-16 only)
- Line cards

## Chassis

Figure 1 shows the front view of a fully loaded GSR-8 chassis. The GSR-8 chassis contains eight slots, numbered from 0 to 7. Slot 0 is in the lower left corner of the chassis and slot 7 is in the upper right corner.

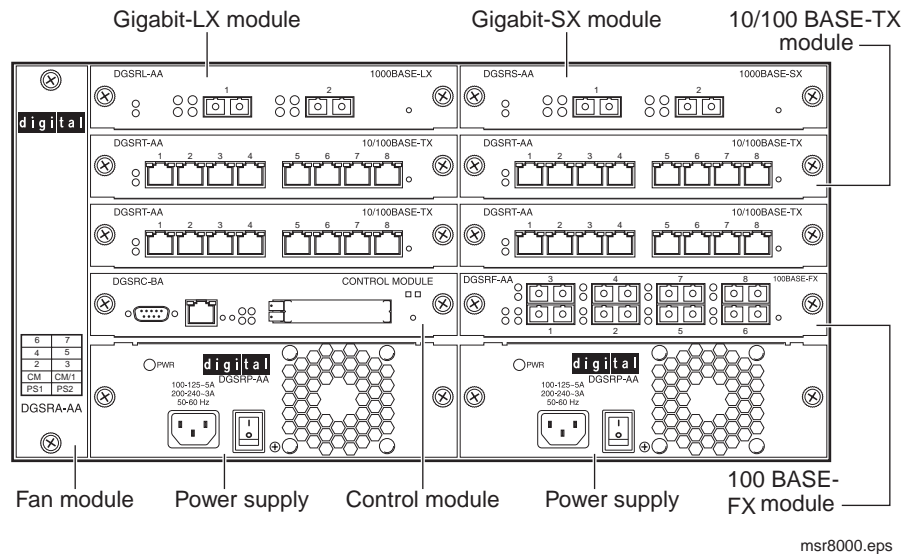

**Figure 1. Front view of a fully loaded GSR-8 chassis**

Figure 2 shows the front view of a fully loaded GSR-16 chassis. The GSR-16 chassis is similar to the GSR-8 chassis, except for the following:

- The chassis can contain up to 16 line cards.
- The switching fabric is stored on a separate module.
- There is a slot for a redundant switching fabric module.
- The power supply is larger.

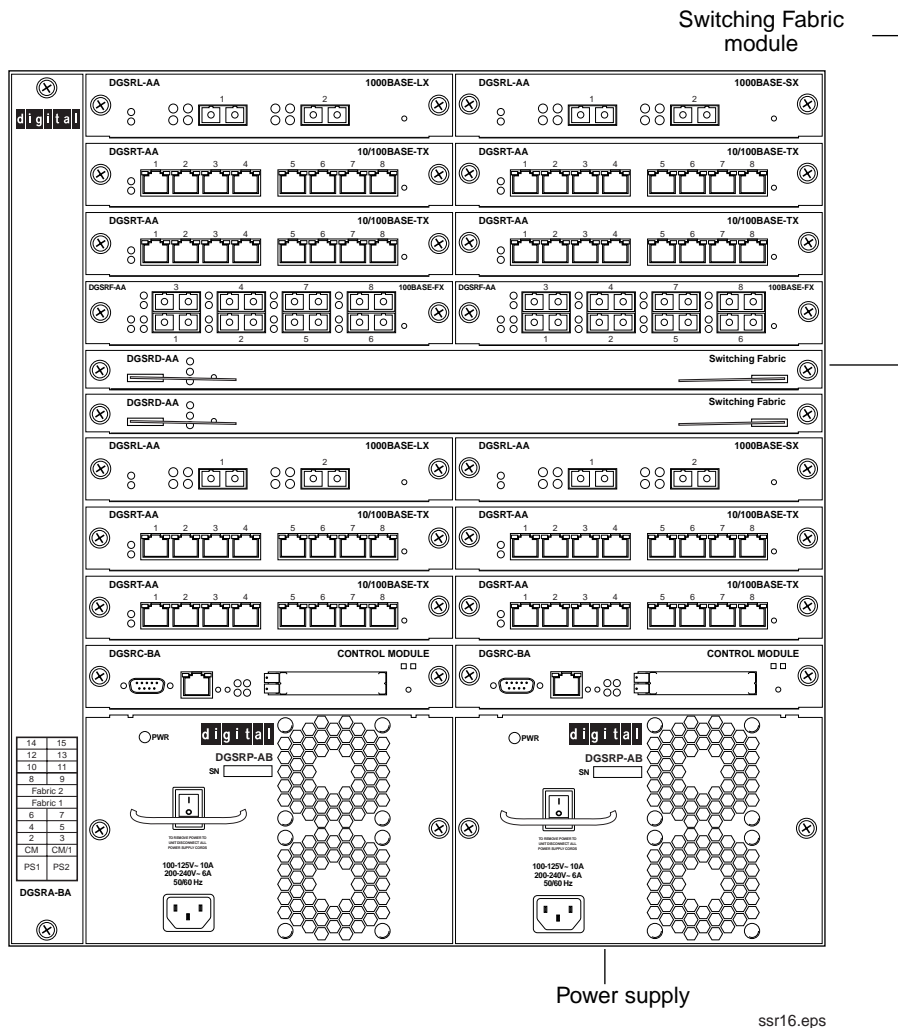

Figure 2. Front view of a fully loaded GSR-16 chassis

The GSR-16 chassis contains sixteen slots, numbered from 0 to 15. Slot 0 is in the lower left corner of the chassis and slot 15 is in the upper right corner. The GSR-16 also has slots for primary and redundant switching fabric modules.

On both the GSR-8 and GSR-16, slot 0 is labeled “CM” and contains the primary Control Module. The CM slot cannot be used for line cards. The primary Control Module must be installed in this slot. The CM/1 slot can contain a redundant Control Module (if you install one) or can contain a line card. Slots 2 – 7 on the GSR-8 or slots 2-15 on the GSR-16 can contain any line cards. (See “Control Module” on page 11 and “Line Cards” on page 15 for information about these items.)

You can install line cards in any order in the slots. For example, you could install line cards in slots 2 and 5 and leave the other line card slots empty. The GSR provides non-blocking throughput regardless of the software features you are using. Therefore, you do not need to “load balance” line cards by placing them in certain relationships to balance the load on the backplane. Regardless of where you install the line cards, the backplane can provide full, non-blocking throughput.

## Backplane

The backplane occupies the rear of the chassis and connects the power supplies, Control Modules, and line cards together. The power supplies use the backplane to provide power to the rest of the system. The line cards and Control Modules use the backplane to exchange control information and packets. The backplane is installed at the factory. Contact DIGITAL if you wish to replace the backplane.

## Fan Module

The GSR contains a fan module to provide cooling air flow across the Control Module(s) and line cards. The fan module is located on the left side of the Control Modules and line cards. The GSR-8 fan module contains two fans; the GSR-16 fan module contains six fans. The fan module is installed at the factory, but you can replace the module yourself if necessary.



**Caution:** To ensure that the fan module can provide adequate cooling, always provide at least 3 inches of clearance on each side of the chassis.

## Control Module

The Control Module is the GSR’s central processing unit. It contains system-wide bridging and routing tables. Traffic that does not yet have an entry in the L2 and L3/L4 lookup tables on individual line cards is sent to the Control Module. After processing traffic, the Control Module updates the L2 and L3/L4 tables on the line cards that received the traffic. The line cards thus “learn” about how to forward traffic.

Figure 3 shows the front panel of the Control Module.

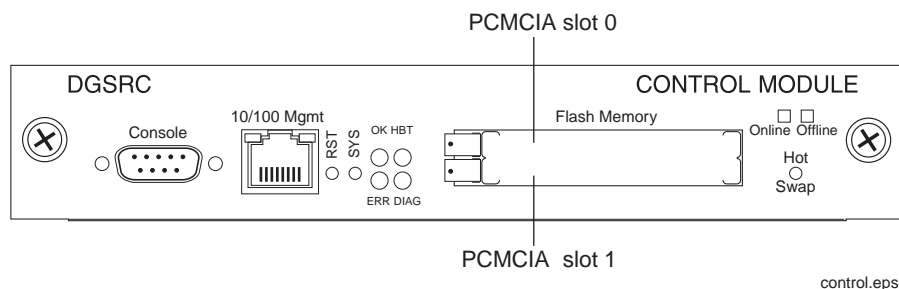

**Figure 3. Front panel of Control Module**

### Boot Flash

The Control Module has a boot flash containing the GSR's boot software and configuration files. The system software image file resides on a PCMCIA card (see below) or a TFTP server.

### Memory Module

The Control Module uses memory to hold the routing tables and other tables. The minimum factory configuration for the Control Module includes 64MB of memory (in a 64MB DIMM). You can obtain GSR memory upgrade kits from DIGITAL to increase memory to 128MB (in a 128MB DIMM), 192MB (in one 64MB DIMM and one 128MB DIMM), or 256MB (in two 128MB DIMMs). See "Installing a Memory Upgrade" on page 31 for the upgrade procedure.

### External Controls

The Control Module has the following external controls. Where appropriate, this guide describes how to use the controls.

- Male DB-9 Data Communications Equipment (DCE) port for serial connection from a management terminal. Use this port to establish a direct CLI connection to the GSR. The default baud rate is 9600.
- 10/100Base-TX Data Terminal Equipment (DTE) port for network ("in-band") connection from a management terminal. The port is configured as Media Data Interface (MDI). Use this port to establish a clearVISN CoreWatch management connection to the GSR over a local or bridged Ethernet segment.
- Reset switch (RST). Use this switch to reboot the GSR's CPU.
- System switch (SYS). This switch stops the system software and starts the debugger. Normally you should not use this switch unless directed to do so by DIGITAL personnel.



- Status LEDs. These LEDs indicate whether the control module is online or offline.
- PCMCIA flash memory slots. These slots let you install system image software upgrades as well as older system image software versions.

**Note:** You can install a PCMCIA card in either slot but you cannot use two PCMCIA cards at the same time.

## Power Supply

The power supply delivers 3.3, 5, and 12 volts DC to the GSR's Control Module(s), fan modules, and other components. A single power supply provides enough current to operate a fully-configured chassis. The power supply has its own internal cooling fan. The vent on the front of the power supply is the inlet vent for the cooling fan.

Figure 4 shows the front view of a GSR-8 power supply.

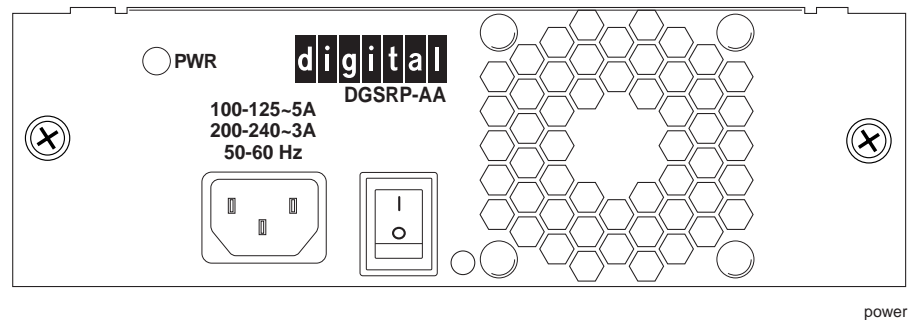

**Figure 4. Front view of a GSR-8 power supply**

The GSR-16 power supply is somewhat larger than the GSR-8 power supply. Figure 5 shows the front view of a GSR-16 power supply.

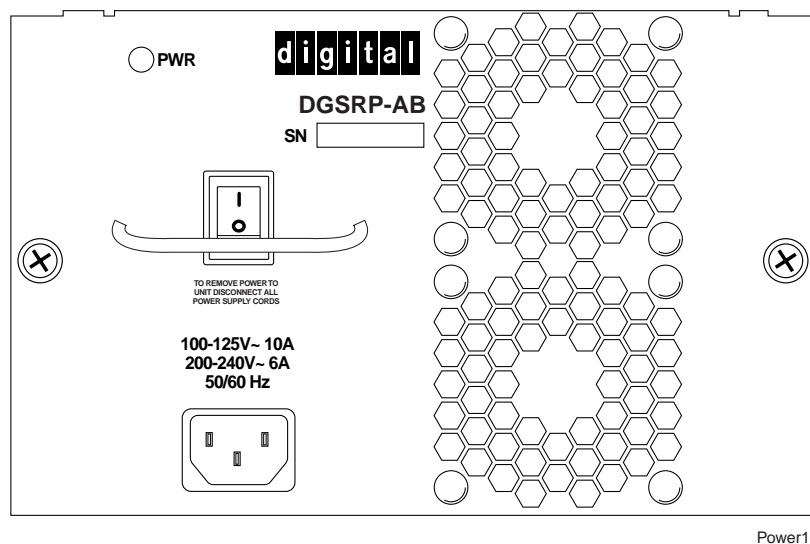

**Figure 5. Front view of a GSR-16 power supply**

The following table lists the specifications for the GSR's power supply.

	GSR-8	GSR-16
Input voltage	100-125, 200-240 VAC	100-125, 200-240 VAC
Input current (maximum)	5, 3 A	10, 6 A

To ensure against equipment failure, you can install a redundant power supply. When two power supplies are active in the GSR, they load share, each supply delivering approximately 50 percent of the current needed. Moreover, if one of the power supplies fails, the other power supply immediately assumes the entire load, thus preventing any system outage.

The power supply has a green status LED. When the LED is lit, the power supply is connected to an appropriate power source and is active. The status LED is lit when you switch the power supply on, not when you plug the power supply into a power source.

## Switching Fabric Module (GSR-16 only)

On the GSR-16, the switching fabric is contained on a separate plug-in module. The GSR-16 has slots for two of these modules. When two switching fabric modules are installed, the module in the slot labelled "Fabric 1" serves as the primary switching fabric module,

and the module in the slot labelled “Fabric 2” serves as a redundant switching fabric module.

Figure 6 shows the front panel of the GSR-16 Switching Fabric module.

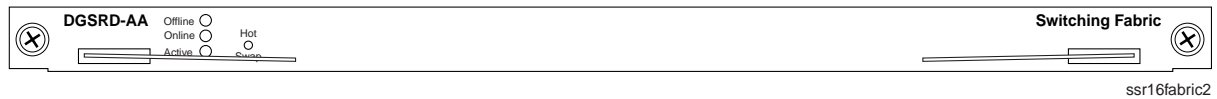

**Figure 6. Front panel of GSR-16 Switching Fabric Module**

### LEDs

The GSR-16 Switching Fabric module uses the following LEDs.

LED	Description
Offline	When lit, this amber LED indicates that the module is offline (powered off) and is ready for hot swap.  The Offline LED also is lit briefly during a reboot or reset of the GSR and goes out as soon as the Control Module discovers and properly initializes the switching fabric module.
Online	When lit, this green LED indicates that the module is online and is ready to receive, process, and send packets if configured to do so.
Active	When lit, this LED indicates that the switching fabric module is actively receiving, processing, and sending packets.

### Line Cards

The following table lists the line cards available for the GSR. The line cards are equipped with either 4 MB or 16 MB of RAM.

Line Card	Product Number	RAM
10/100BASE-TX	DGSRT-AA	4 MB
100BASE-FX	DGSRF-AA	
1000BASE-SX	DGSRS-AA	
1000BASE-LX	DGSRL-AA	

Line Card	Product Number	RAM
10/100BASE-TX	DGSRT-AB	16 MB
100BASE-FX	DGSRF-AB	
1000BASE-SX	DGSRS-AB	
1000BASE-LX	DGSRL-AB	

A GSR with every slot filled with 4 MB line cards provides 500,000 flows on the GSR-8 and 1,000,000 flows on the GSR-16. A GSR with every slot filled with 16 MB line cards provides 2,000,000 flows on the GSR-8 and 4,000,000 flows on the GSR-16.

**Note:** DIGITAL recommends that you populate your GSR with either all 4 MB line cards or all 16 MB line cards.

### 10/100BASE-TX Line Card

The 10/100BASE-TX line card contains eight independent Ethernet ports. Each port senses whether it is connected to a 10-Mbps segment or a 100-Mbps segment and automatically configures itself as a 10Base-T or 100Base-TX port. Figure 7 shows the front panel of the 10/100BASE-TX line card.

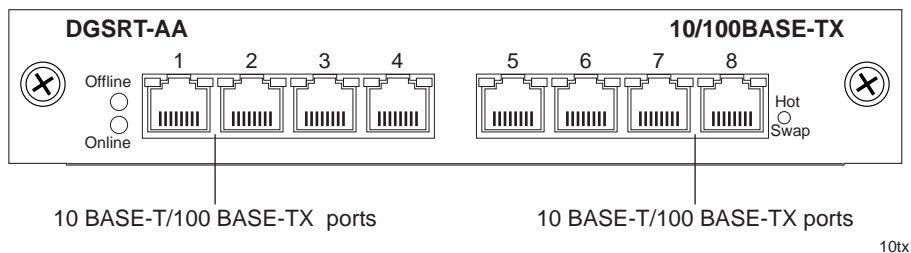

Figure 7. Front panel of 10/100BASE-TX line card

## Cabling and Connector Specifications

The following table lists the media specifications for the 10/100BASE-TX line card.

Port type	Specification
10Base-T	<ul style="list-style-type: none"> <li>• 802.3 standard</li> <li>• RJ-45 connector wired as Media Data Interface Crossed (MDIX); see “10/100Base-TX Line Card” on page 41 for pin assignments</li> <li>• EIA Category 3, 4, or 5 unshielded twisted pair cabling</li> <li>• Maximum 100 meters (328 feet) segment length</li> </ul>
100Base-TX	<ul style="list-style-type: none"> <li>• 802.3u standard</li> <li>• RJ-45 connector wired as Media Data Interface Crossed (MDIX); see “10/100Base-TX Line Card” on page 41 for pin assignments</li> <li>• EIA Category 5 unshielded twisted pair cabling</li> <li>• Maximum 100 meters (328 feet) segment length</li> </ul>

## LEDs

The 10/100BASE-TX line card uses the following LEDs.

LED	Description
Offline	<p>When lit, this amber LED on the left side of the line card indicates that the line card is offline (powered off) and is ready for hot swap.</p> <p>The Offline LED also is lit briefly during a reboot or reset of the GSR and goes out as soon as the Control Module discovers and properly initializes the line card.</p>
Online	<p>When lit, this green LED indicates that the line card is online and is ready to receive, process, and send packets if configured to do so.</p>
Link	<p>Each port has two LEDs on its connector. The green LED on the left side of the connector indicates the link status. When this LED is lit, the port hardware is detecting that a cable is plugged into the port and the port has established communication with the device at the other end.</p>
Activity	<p>The amber LED on the right side of each port connector flashes each time the port’s transceiver sends or receives packets.</p>

### 100BASE-FX Line Card (Multimode Fiber-optic Cable)

The 100BASE-FX line card provides the same features as the 10/100BASE-TX line card but uses multimode fiber-optic cable (MMF) to connect to the network. Figure 8 shows the front panel of the 100BASE-FX line card.

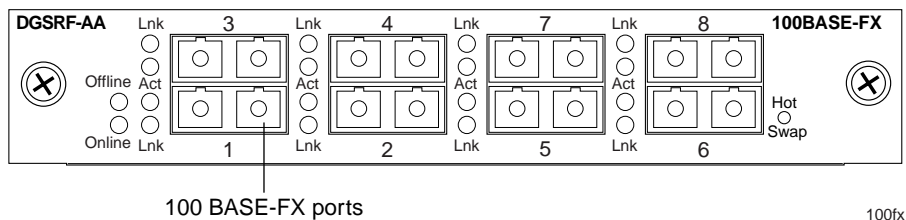

Figure 8. Front panel of 100BASE-FX line card (MMF)

### Cabling and Connector Specifications

The following table lists the media specifications for the 100BASE-FX line card.

Port type	Specification
100BASE-FX	<ul style="list-style-type: none"> <li>• 802.3u standard</li> <li>• SC-style Media Interface Connector (MIC); either connection pin in the MIC can be used for transmit or receive.</li> <li>• 62.5 micron multimode fiber-optic cable</li> <li>• Maximum 412 meters (1352 feet) segment length for half-duplex links</li> <li>• Maximum 2 kilometers (6562 feet) segment length for full-duplex links</li> </ul>

## LEDs

The 100BASE-FX line card uses the following LEDs.

LED	Description
Offline	When lit, this amber LED on the left side of the line card indicates that the line card is offline (powered off) but is ready for hot swap.  The Offline LED also is lit briefly during a reboot or reset of the GSR but goes out as soon as the Control Module discovers the line card.
Online	When lit, this green LED indicates that the line card is online and is ready to receive, process, and send packets if configured to do so.
Lnk	Each port has two LEDs located to the left of the connector. The green Lnk LED indicates the link status. When this LED is lit, the port hardware is detecting that a cable is plugged into the port and the port has established communication with the device at the other end.
Act	The amber Act LED flashes each time the port's transceiver sends or receives packets.

## 1000BASE-SX Line Card

The 1000BASE-SX line card contains two independent Gigabit (1000-Mbps) Ethernet ports. The ports connect to multimode-mode fiber (MMF) cables. Figure 9 shows the front panel of the 1000BASE-SX line card.

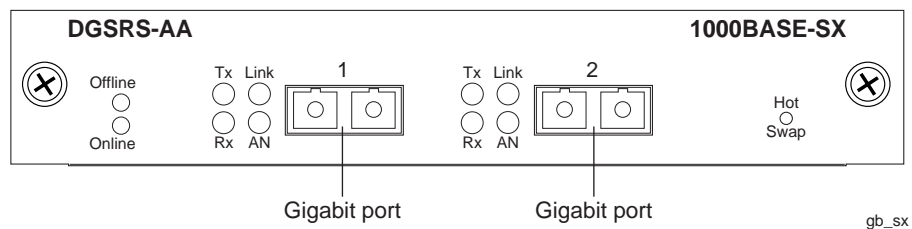

Figure 9. Front panel of 1000BASE-SX line card

## Cabling and Connector Specifications

The following table lists the media specifications for the 1000BASE-SX line card.

Port type	Specification
1000Base-SX	<ul style="list-style-type: none"> <li>• 802.3z standard (also uses 802.3x for flow control)</li> <li>• SC-style Media Interface Connector (MIC); either connection pin in the MIC can be used for transmit or receive.</li> <li>• 62.5 micron or 50 micron multimode fiber-optic cable</li> <li>• Maximum 220 or 275 meters (722 or 902 feet) segment length for 62.5 micron fiber-optic cable, based on installed fiber bandwidth</li> <li>• Maximum 500 or 550 meters (1640 or 1804 feet) segment length for 50 micron fiber-optic cable, based on installed fiber bandwidth</li> </ul>

**Note:** The 802.3z specification has not been ratified and all distance capabilities are subject to change.

## LEDs

The 1000BASE-SX line card uses the following LEDs.

LED	Description
Offline	<p>When lit, this amber LED on the left side of the line card that indicates that the line card is offline (powered off) but is ready for hot swap.</p> <p>The Offline LED also is lit briefly during a reboot or reset of the GSR but goes out as soon as the Control Module discovers the line card.</p>
Online	<p>When lit, this green LED indicates that the line card is online and is ready to receive, process, and send packets if configured to do so.</p>
Per-port Link	<ul style="list-style-type: none"> <li>• Green – indicates that the port hardware detects a cable plugged into the port and a good link is established.</li> <li>• Red (intermittent) – indicates that the port received an error during operation.</li> <li>• Red (solid) – indicates that the port hardware detects a cable plugged into the port, however, a bad link is established.</li> <li>• Off – indicates that no link from exists with the port.</li> </ul>



LED	Description
Per-port Rx	<ul style="list-style-type: none"> <li>Green – indicates when the port’s transceiver receives packets.</li> <li>Orange – indicates when the port’s transceiver receives flow-control packets.</li> </ul>
Per-port Tx	<ul style="list-style-type: none"> <li>Green – indicates when the port’s transceiver transmits packets.</li> <li>Orange – indicates when the port’s transceiver transmits flow-control packets.</li> </ul>
Per-port AN	<ul style="list-style-type: none"> <li>Green – indicates that the line card has autonegotiated the operating mode of the link between full-duplex and half-duplex.</li> <li>Orange (intermittent) – indicates that autonegotiation is in process.</li> <li>Orange (solid) – indicates a problem with autonegotiation configuration.</li> <li>Red – indicates an autonegotiation failure. This fault may occur if the link partner does not support full duplex.</li> <li>Off – indicates that autonegotiation has been disabled or the link is down.</li> </ul>

### 1000BASE-LX Line Card

The 1000BASE-LX line card provides the same features as the 1000BASE-SX line card, but supports singlemode fiber (SMF) as well as MMF. Figure 10 shows the front panel of the 1000BASE-LX line card.

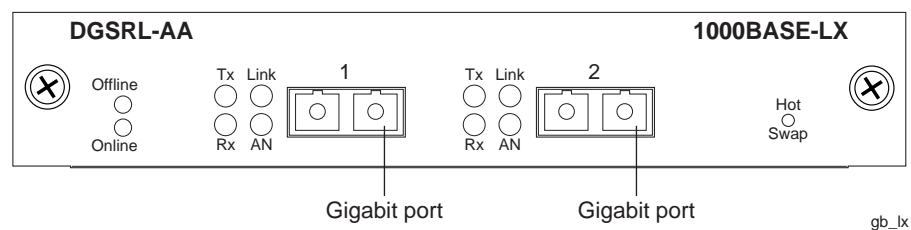

Figure 10. Front panel of 1000BASE-LX line card

## Cabling and Connector Specifications

The following table lists the media specifications for the 1000BASE-LX line card.

Port type	Specification
1000Base-LX	<ul style="list-style-type: none"> <li>• 802.3z standard (also uses 802.3x for flow control)</li> <li>• SC-style Media Interface Connector (MIC); either connection pin in the MIC can be used for transmit or receive.</li> <li>• 62.5 micron or 50 micron multimode fiber-optic cable</li> <li>• 9.5 micron single-mode fiber-optic cable</li> <li>• Maximum 550 meters (1804 feet)<sup>a</sup> segment length for 62.5 micron multimode fiber-optic cable</li> <li>• Maximum 550 meters (1804 feet) segment length for 50 micron multimode fiber-optic cable</li> <li>• Maximum 5 kilometers (16400 feet) segment length for 10 micron single-mode fiber-optic cable</li> </ul>

a. Patch cord required.

**Note:** The 802.3z specification has not been ratified and all distance capabilities are subject to change.

## LEDs

The 1000BASE-LX line card uses the following LEDs.

LED	Description
Offline	<p>When lit, this amber LED on the left side of the line card that indicates that the line card is offline (powered off) but is ready for hot swap.</p> <p>The Offline LED also is lit briefly during a reboot or reset of the GSR but goes out as soon as the Control Module discovers the line card.</p>
Online	<p>When lit, this green LED indicates that the line card is online and is ready to receive, process, and send packets if configured to do so.</p>

LED	Description
Per-port Link	<ul style="list-style-type: none"> <li>• Green – indicates that the port hardware detects a cable plugged into the port and a good link is established.</li> <li>• Red (intermittent) – indicates that the port received an error during operation.</li> <li>• Red (solid) – indicates that the port hardware detects a cable plugged into the port, however, a bad link is established.</li> <li>• Off – indicates that no link from exists with the port.</li> </ul>
Per-port Rx	<ul style="list-style-type: none"> <li>• Green – indicates when the port’s transceiver receives packets.</li> <li>• Orange – indicates when the port’s transceiver receives flow-control packets.</li> </ul>
Per-port Tx	<ul style="list-style-type: none"> <li>• Green – indicates when the port’s transceiver transmits packets.</li> <li>• Orange – indicates when the port’s transceiver transmits flow-control packets.</li> </ul>
Per-port AN	<ul style="list-style-type: none"> <li>• Green – indicates that the line card has autonegotiated the operating mode of the link between full-duplex and half-duplex.</li> <li>• Orange (intermittent) – indicates that autonegotiation is in process.</li> <li>• Orange (solid) – indicates a problem with autonegotiation configuration.</li> <li>• Red – indicates an autonegotiation failure. This fault may occur if the link partner does not support full duplex.</li> <li>• Off – indicates that autonegotiation has been disabled or the link is down.</li> </ul>



# Chapter 2

## Hardware Installation

This chapter provides hardware installation information and procedures in the following sections:

- Safety considerations
- Installing the hardware

If the hardware is already installed and you are ready to install the software and perform basic system configuration, see Chapter 3, “Software Installation and Setup” on page 45.

### Safety Considerations

Read the following safety warnings and product cautions to avoid personal injury or product damage.

### Preventing Injury

Observe the following safety warnings to prevent accidental injury when working with the DIGITAL GIGAswitch/Router hardware.



**Warnings:** To prevent personal injury, follow these safety precautions when installing and using the GSR:

- To avoid back strain, be careful when lifting the chassis out of the shipping box.
- Never attempt to rack mount the GSR chassis unaided. Ask an assistant to help you hold the chassis.
- Never operate the GSR with exposed power-supply bays or module slots. You can leave the PCMCIA slots exposed but make sure you do not place any tools or body parts in the PCMCIA slot.

- Never operate the GSR if the chassis becomes wet or the area where the chassis is installed is wet.

## Preventing Equipment Damage

Observe the precautions listed in this section to prevent accidental damage to the GSR components.



**Cautions:** To prevent accidental product damage, observe the following precautions:

- Always use proper electrostatic discharge (ESD) gear when handling the Control Module, backplane, line cards or other internal parts of the chassis.
- Make sure you allow adequate room for air flow around the chassis.
- If you plan to install the chassis in an equipment rack, it is recommended that you install a support tray under the chassis, especially for chassis that are completely filled (no empty Control Module, power supply, or line card slots).

## Hardware Specifications

The following table lists the physical and environmental specifications for the GSR-8 and GSR-16.

	GSR-8	GSR-16
Dimensions	Inches: 8.27" x 17.25" x 12.25" Centimeters: 22.23cm x 43.82cm x 31.12cm	Inches: 8.27" x 17.25" x 19.25" Centimeters: 22.23cm x 43.82cm x 31.12cm
Weight	Pounds: 24 Kilograms: 10.8	Pounds: 47 Kilograms: 21.2
Power	100-125 VAC, 5A maximum; 200-240 VAC, 3A maximum	100-125 VAC, 10A maximum; 200-240 VAC, 6A maximum
Operating temperature	Fahrenheit: 41°F to 104°F Centigrade: 5°C to 40°C	Fahrenheit: 41°F to 104°F Centigrade: 5°C to 40°C

## Installing the Hardware

This section describes how to perform the following tasks:

- Check the shipping box to ensure that all the parts arrived
- Install the chassis (on a tabletop or in an equipment rack)
- Install the Control Module
- Install a memory upgrade
- Install the switching fabric module (GSR-16 only)
- Install line cards
- Install the power supply
- Attach console management cables
- Attach port cables

## Verifying Your Shipment

Before you begin installing your GSR, check your shipment to ensure that everything you ordered arrived securely.



**Warning:** To avoid back strain, be careful when lifting the chassis out of the shipping box.

Open the shipping box(es) and verify that you received the following equipment:

- A GSR-8 or GSR-16 chassis containing a backplane, fan module, switch fabric module (GSR-16 only), and a console cable. The console cable is used for connecting a terminal to the Control Module DB-9 port.
- A GSR-8 or GSR-16 power supply.
- Two power cables.
- One Control Module.
- A GSR Media Kit containing:
  - A CD-ROM containing the DIGITAL clearVISN CoreWatch element management software and user documentation.
  - One PCMCIA flash card containing the GSR system software.
  - One copy of the *DIGITAL GIGAswitch/Router Getting Started Guide* (the book you are reading now).

Depending on your order, your shipment may also contain some or all of the following:

- Redundant power supply, if you ordered one.
- Redundant Control Module, if you ordered one.
- Redundant Switching Fabric Module, if you ordered one (GSR-16 only).
- The line cards you ordered.
- Country-specific power cord — one per chassis.

## Installing the Chassis

This section contains procedures for the following types of installation:

- Table-top Installation
- Rack mount Installation

### Table-Top Installation

You can install the GSR on a tabletop.

1. Select a table that is stable (not wobbly) and is not in an area subject to frequent foot traffic. Remember that you will be attaching numerous cables to the chassis.
2. Place the GSR on the table, allowing at least 3 inches of room above and behind the unit for air flow to the cooling fans.

### Rack Mount Installation

You can install the GSR in a standard 19" equipment rack. The GSR chassis is equipped with front-mounting brackets. Figure 11 shows an example of how to install a GSR-16 chassis in an equipment rack.



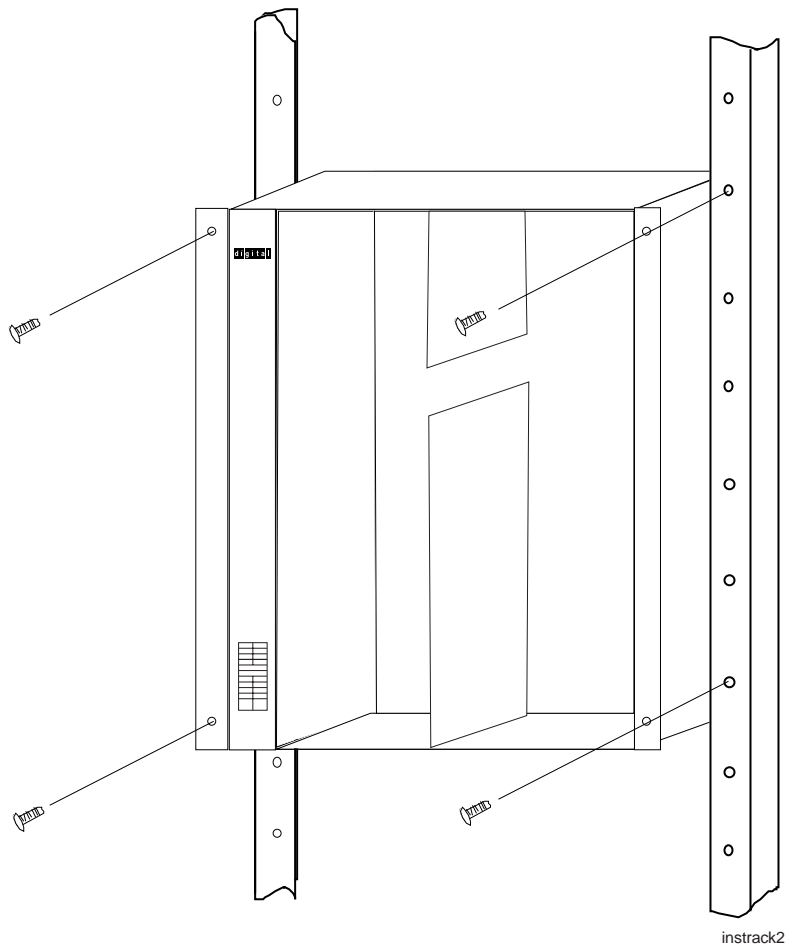

**Figure 11. Installing the GSR-16 chassis in an equipment rack**



**Warning:** Never attempt to rack mount the GSR chassis unaided. Ask an assistant to help you hold the chassis.



**Caution:** To make lifting and holding the chassis easier, install the chassis before you install line cards or redundant Control Modules and power supplies.

To install the GSR chassis in an equipment rack, use the following procedure. You need a #2 Phillips-head screwdriver to perform this procedure.

1. If the front-mounting brackets are already installed on the GSR chassis, go to Step 2.

If not, do the following:

- a. Align one of the mounting brackets over the corresponding holes in the side of the chassis. The mounting bracket is correctly positioned when the side with two open mounting holes is flush with the front of the chassis.

- b. Use the #2 Phillips-head screwdriver and of the supplied Phillips-head screws to attach the mounting bracket to the chassis.
  - c. Attach the other mounting bracket.
2. Along with an assistant, lift the chassis into place in the mounting rack.
3. While your assistant holds the chassis in place, use the #2 Phillips-head screwdriver and four #2 Phillips-head screws to attach the mounting brackets to the mounting rack.

**Note:** Make sure there is at least 3 inches of room above and behind the unit for air flow to the cooling fans.



**Caution:** Make sure the screws are tight before your assistant releases the chassis. If you accidentally leave the screws loose, the chassis can slip and fall, possibly becoming damaged.

## Installing the Control Module

The primary Control Module always resides in the CM slot. If you need to replace the primary Control Module in the CM slot, or you want to install a redundant Control Module in slot CM/1, use the following procedure. You will need a #2 Phillips-head screwdriver to perform this procedure.

The primary Control Module must be installed in slot CM. The redundant Control Module must be installed in slot CM/1. (See “Chassis” on page 9 for information about the chassis slots.)

Figure 12 shows an example of how to install a Control Module. The procedure following the figure describes how to do this.

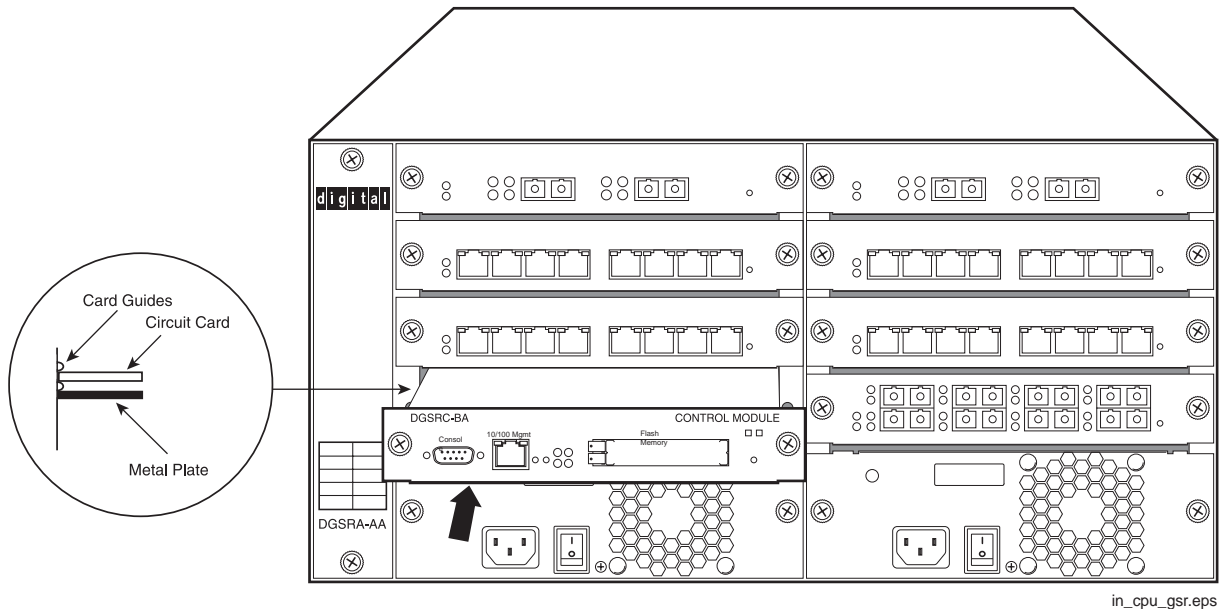

**Figure 12. Installing a Control Module**

To install a Control Module:

1. If a cover plate is installed over the Control Module slot (slot CM or CM/1 only), use the #2 Phillips-head screwdriver to remove it.
2. Slide the Control Module all the way into the slot, firmly but gently pressing to ensure that the pins on the back of the Control Module are completely seated in the backplane.

**Note:** Make sure the circuit card (and not the metal plate) is between the card guides, as shown in Figure 12. Check both the upper and lower tracks.

3. Use the #2 Phillips-head screwdriver to tighten the captive screws on each side of the Control Module to secure the Control Module to the chassis.
4. When you are ready to attach the management cables to the Control Module, use the procedures in “Attaching the Console Management Cables” on page 36.

## Installing a Memory Upgrade

The Control Module is shipped from the factory with a minimum of 64MB memory (in a 64MB DIMM). Memory upgrade kits can be obtained from DIGITAL to increase memory to 128 MB or 256 MB. Use the following procedure to upgrade the memory to 128MB (one

128MB DIMM) or 256MB (two 128MB DIMMs). You will need a #2 Phillips-head screwdriver to perform this procedure.

1. If the chassis contains an active, redundant Control Module, go to Step 2. Otherwise, if the GSR chassis does not contain a redundant Control Module, power down the chassis by switching the power switch on the power supply to the Off position.
2. Use a #2 Phillips-head screwdriver to loosen the captive screws on the Control Module.
3. Pull the Control Module out of the chassis and place the module on an ESD-safe work area.
4. Remove the DIMMS from the memory slots. Figure 13 shows the locations of the DIMM slots.

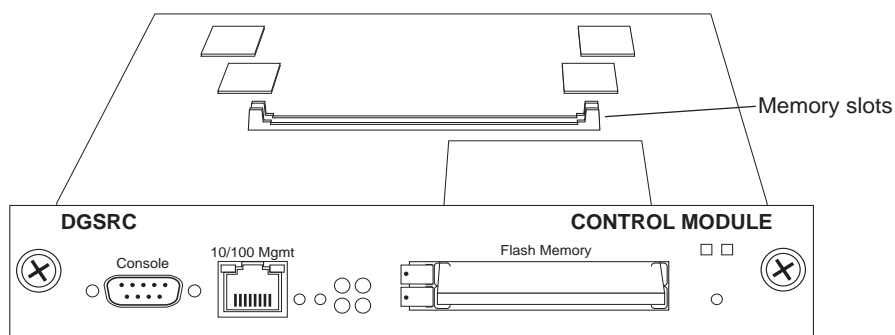

CM\_TOP.eps

**Figure 13. Location of DIMM slots**

5. Store the DIMMs in an ESD-safe bag or other container and put them in a safe place.
6. Insert the new DIMMs in the slots, making sure that the contacts are fully inserted downward into the connector slot.
7. Install the upgraded Control Module back into the chassis. (See "Installing the Control Module" on page 30.)

## Installing the Switching Fabric Module (GSR-16 only)

On the GSR-16, the switching fabric module is shipped separately from the GSR chassis. To install or replace the primary switching fabric module, or if you want to install a redundant switching fabric module, use the following procedure. You will need a #2 Phillips-head screwdriver to perform this procedure

The primary switching fabric module must be installed in slot Fabric 1. The redundant switching fabric module must be installed in slot Fabric 2.

Figure 14 shows an example of how to install a switching fabric module. The procedure following the figure describes how to do this.

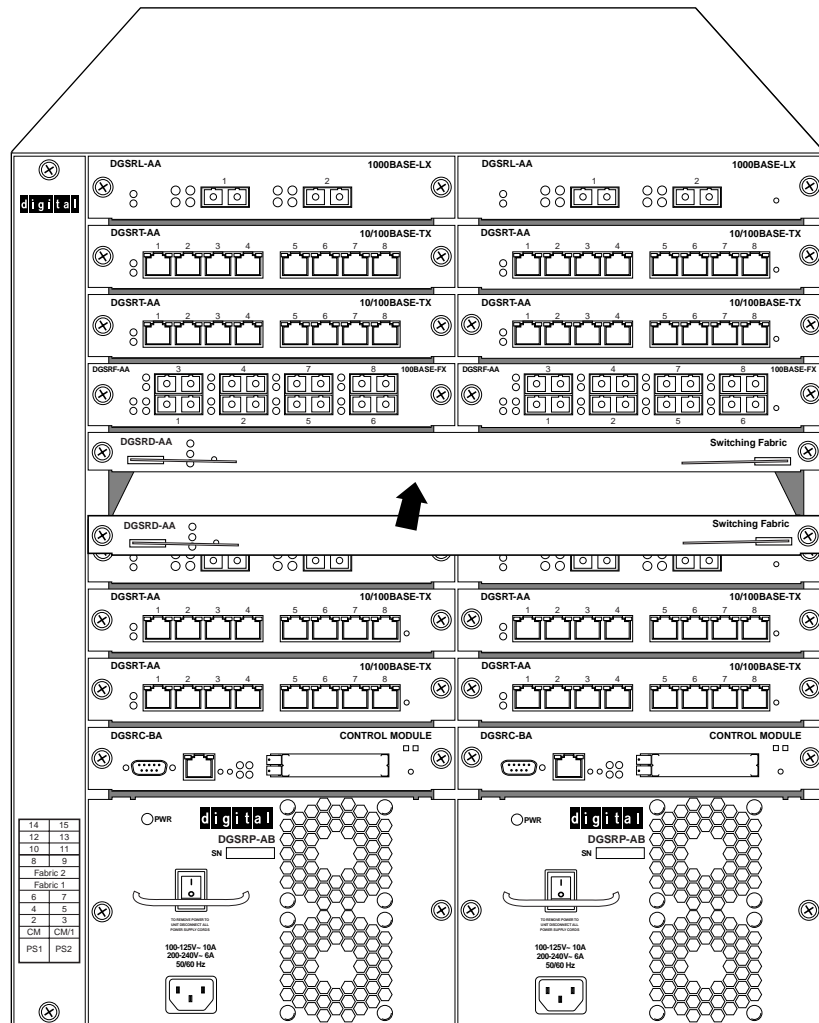

infab2

**Figure 14. Installing a switching fabric module on the GSR-16**

To install a switching fabric module:

1. If a cover plate is installed over the switching fabric module slot (slot Fabric 1 or Fabric 2), use the #2 Phillips-head screwdriver to remove the cover plate.
2. Slide the switching fabric module all the way into the slot, firmly but gently pressing to ensure that the pins on the back of the module are completely seated in the backplane.

**Note:** Make sure the circuit card (and not the metal plate) is between the card guides, as shown in Figure 12 on page 31. Check both the upper and lower tracks.

3. Lock down the left and right metal tabs to secure the switching fabric module to the chassis.
4. Use the #2 Phillips-head screwdriver to tighten the captive screws on each side of the switching fabric to secure the switching fabric to the chassis.

## Installing the Line Cards

You can install line cards in slots 1 – 7 (or 1 – 15 on the GSR-16). If you also plan to install a redundant Control Module, you can install line cards in slots 2 – 7 (2– 15 on the GSR-16). You will need a #2 Phillips-head screwdriver to perform this procedure.



**Warning:** The GSR supports hot swapping. This means you can remove and insert line cards while the GSR is operating. However, you should not insert tools or body parts inside the chassis while it is powered on. Doing so can cause electrical shock or equipment damage.

Figure 15 shows an example of how to install a line card. The procedure following the figure describes how to do this.

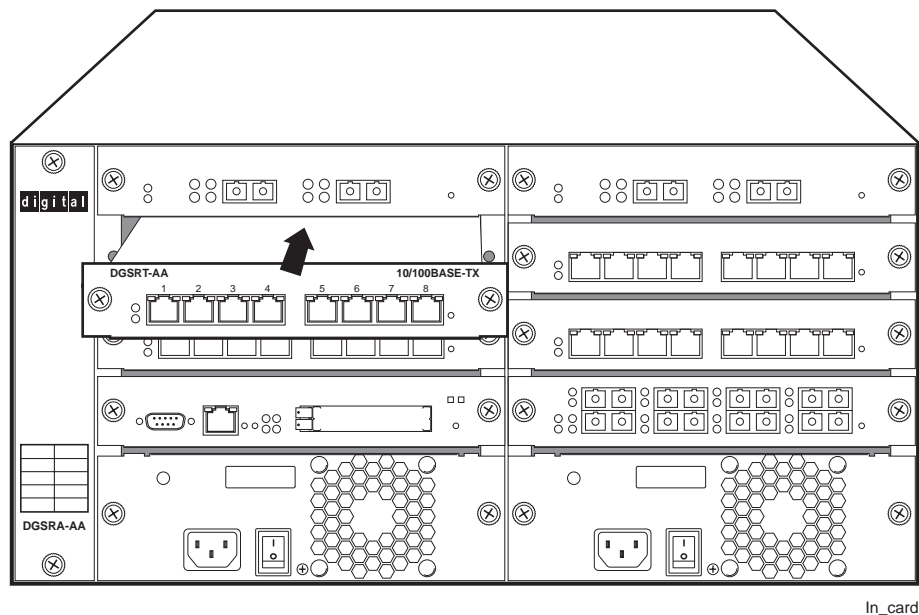

Figure 15. Installing a line card

To install a line card:

1. If a cover plate is installed over the line card slot, use the #2 Phillips-head screwdriver to remove it.
2. Slide the line card all the way into the slot, firmly but gently pressing the line card fully in place to ensure that the pins on the back of the line card are completely seated in the backplane.  
**Note:** Make sure the circuit card (and not the metal plate) is between the card guides, as shown in Figure 12 on page 31. Check both the upper and lower tracks.
3. Use the #2 Phillips-head screwdriver to tighten the captive screws on each side of the line card to secure the line card to the chassis.
4. Repeat the above steps for the remaining cards.
5. When you are ready to attach the segment cables, use the procedures in “Attaching the Segment Cables” on page 40.

## Installing a Power Supply

The primary power supply is shipped separately from the GSR chassis. To install or replace the primary power supply or if you want to install a redundant power supply, use the following procedure. You will need a #2 Phillips-head screwdriver to perform this procedure.

**Note:** Use a single-phase grounded power source located within 6 feet of the installation site.

Figure 16 shows an example of how to install a power supply. The procedure following the figure describes how to do this.

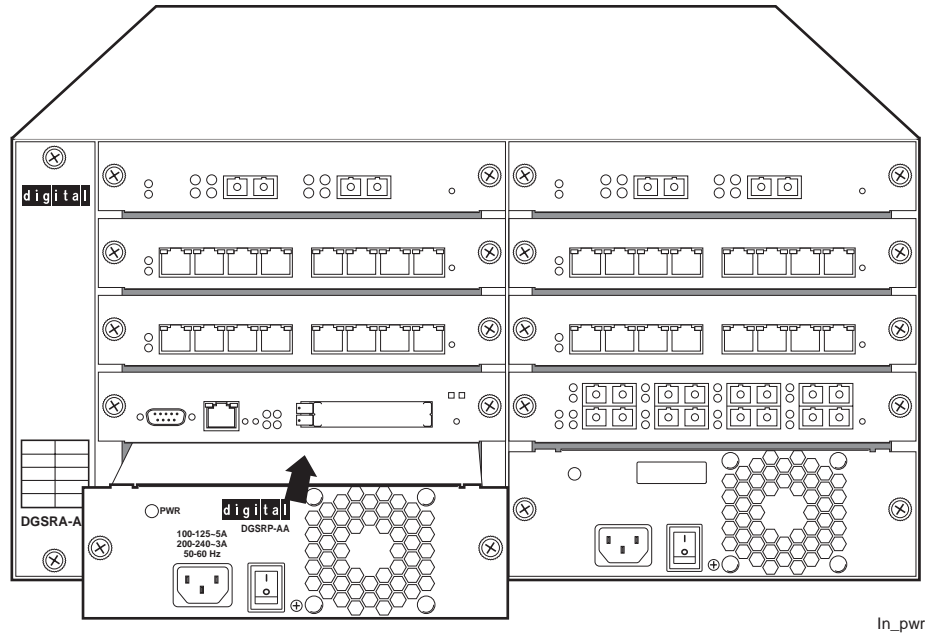

**Figure 16. Installing a power supply**

To install a power supply:

1. Ensure that the power supply is not powered on.
2. If a cover plate is installed over the power supply slot, use the #2 Phillips-head screwdriver to remove it. If you are replacing a power supply, unplug the power cable from the supply you are replacing, loosen the captive screws on the power supply's front panel, then pull the supply out of the chassis.
3. Slide the power supply all the way into the slot, firmly but gently pressing to ensure that the pins on the back of the power supply are completely seated in the backplane.
4. Use the #2 Phillips-head screwdriver to tighten the captive screws on each side of the power supply to secure the power supply to the chassis.
5. Attach the power cable to your power supply.

## Attaching the Console Management Cables

The Control Module has two ports for attaching management consoles to the GSR.



- A male DB-9 DCE port for direct serial connection from a terminal. You use this port to perform basic setup, including setting up the GSR for management through the network using clearVISN CoreWatch or SNMP.
- An RJ-45 10/100Base-T DTE port for Telnet connection from a host on the network. The port is configured for Media Data Interface (MDI). You use this port to manage the GSR using clearVISN CoreWatch or SNMP.

### Connecting to the Serial Port

Figure 17 shows where to plug in the cable to the Control Module's serial port. The procedure following the figure describes how to set up and insert the cable

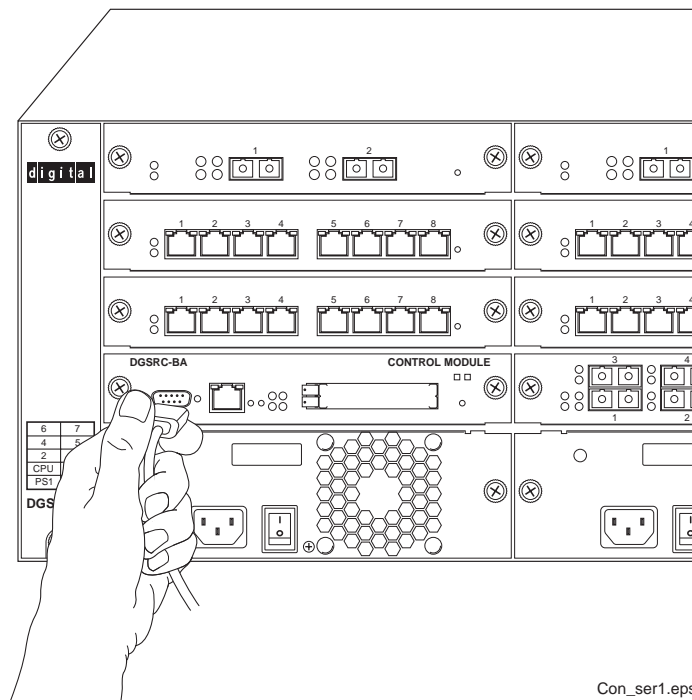

**Figure 17. Plugging in to the Control Module's serial (DB-9 DCE) port**

To attach the supplied console cable to the Control Module DB-9 port:

1. Locate the console cable included with the GSR Chassis. The console cable is a female to female DB-9 crossover cable. Thus, pin 2 (TXD or "transmit data") emerges on the management console's end of the connection as RXD ("receive data"), and so on.

The following table lists the pin assignments for the male DB-9 connector on the Control Module and for the male DB-9 connector on the management console.

Control Module DB-9 Connector (DCE)	Pin Number	Management Console DB-9 Connector (DTE)
Unused	1	Unused
TXD (transmit data)	2	RXD (receive data)
RXD (receive data)	3	TXD (transmit data)
Unused	4	Unused
GND (ground)	5	GND (ground)
DTR (data terminal ready)	6	DSR (data set ready)
CTS (clear to send)	7	RTS (request to send)
RTS (request to send)	8	CTS (clear to send)
Unused	9	Unused

2. Plug one end of the console cable into the Control Module's DCE DB-9 port.
3. Plug the other end of the console cable into the management console's DTE port.
4. When you are ready to begin configuring the GSR, use procedures in Chapter 3 to power on the switch and boot the software. You will perform initial setup by entering CLI commands on the management console.

### Connecting to the 10/100Base-TX Port

Use the RJ-45 10/100Base-TX DTE port for Telnet connection from a host on the network. The port is configured for Media Data Interface (MDI). Figure 18 shows where to plug in to the Control Module's 10/100Base-TX port. The procedure following the figure describes how to set up and insert the cable.

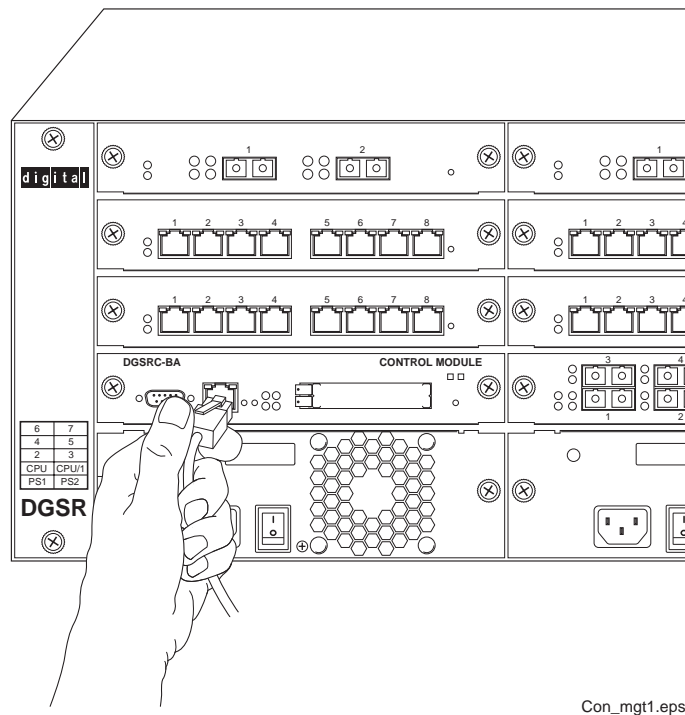

Con\_mgt1.eps

**Figure 18. Plugging in to the Control Module's 10/100Base-TX port**

To attach a cable to the 10/100Base-TX port:

1. Obtain a cable with an RJ-45 connector. Pin 1 (TXD or "transmit data") must emerge on the management console's end of the connection as RXD ("receive data") and so on.

The following table lists the pin assignments for the RJ-45 connector on the Control Module and for the RJ-45 connector on the management console.

Control Module RJ-45 Connector	Pin Number	Management Console RJ-45 Connector
TXD (transmit data)	1	RXD (receive data)
TXD (transmit data)	2	RXD (receive data)
RXD (receive data)	3	TXD (transmit data)
Unused	4	Unused
Unused	5	Unused
RXD (receive data)	6	TXD (transmit data)

<b>Control Module RJ-45 Connector</b>	<b>Pin Number</b>	<b>Management Console RJ-45 Connector</b>
Unused	7	Unused
Unused	8	Unused

2. After ensuring that the pin assignments on both ends of the connection are correct, plug the appropriate end of the connection into the Control Module's RJ-45 10/100Base-TX port.
3. Plug the other end of the connection into the management console's port.
4. When you are ready to configure the GSR using clearVISN CoreWatch or SNMP, use procedures in Chapter 4 to start an SNMP or clearVISN CoreWatch management session.

## Attaching the Segment Cables

The following sections describe how to connect the GSR line cards to your network.

## 10/100Base-TX Line Card

Figure 19 shows where to plug your 10/100Base-T or 100Base-TX cable into a port on the 10/100Base-TX line card. The procedure following the figure explains how to set up and insert the cable.

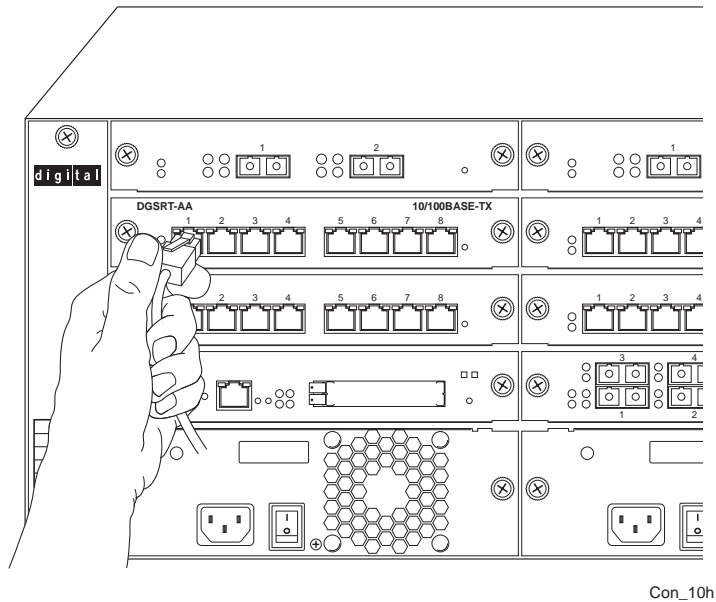

Con\_10h

**Figure 19. Plugging Ethernet cable into 10/100Base-TX line card port**

To attach the segment cables to your 10/100Base-TX line cards:

1. For all the 10/100-Mbps ports, obtain copper cables that have the following pin assignments. The RJ-45 connectors on the 10/100 line cards are configured as Media Data Interface Crossed (MDIX). You can use Category 3 ("Cat-3") or higher wire for 10-Mbps segments. For 100-Mbps segments, use Cat-5 or higher wire. The ports automatically sense which type of segment they are connected to and configure themselves to transmit and receive at the appropriate bandwidth.

The following table lists the pin assignments for the RJ-45 connector on the line card and for the RJ-45 connector on the switch, router, or host on the other end of the segment cable.

Line Card RJ-45 Connector	Pin Number	RJ-45 Connector at Other End of Segment
RXD (receive data)	1	TXD (transmit data)
RXD (receive data)	2	TXD (transmit data)
TXD (transmit data)	3	RXD (receive data)

Line Card RJ-45 Connector	Pin Number	RJ-45 Connector at Other End of Segment
Unused	4	Unused
Unused	5	Unused
TXD (transmit data)	6	RXD (receive data)
Unused	7	Unused
Unused	8	Unused

Figure 20 shows the pin positions in the 10/100Base-TX connectors.

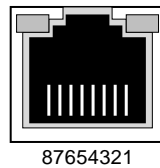

**Figure 20. 10/100Base-TX RJ-45 connector**

2. Plug one end of the cable into the line card and the other end into the hardware at the other end of the connection.

### 1000Base-SX Line Card and 100Base-FX Line Card

The 1000Base-SX and 100Base-FX line cards support multimode fiber (MMF). Figure 21 shows where to plug your fiber cable into a port on the 100Base-FX line card. Figure 22 shows how to plug your fiber cable into a port on the 1000Base-SX line card.

The procedure following the figures describes how to set up and insert the cables.

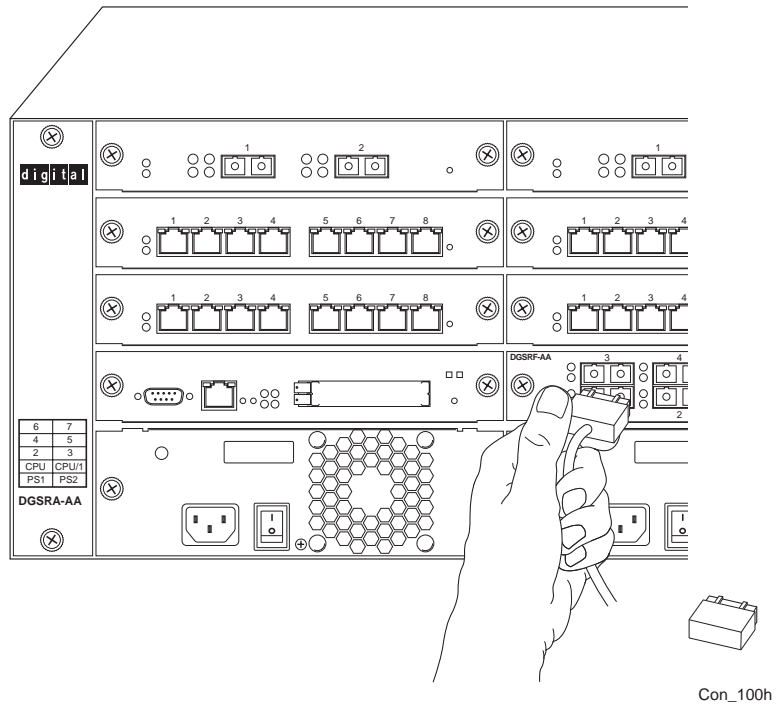
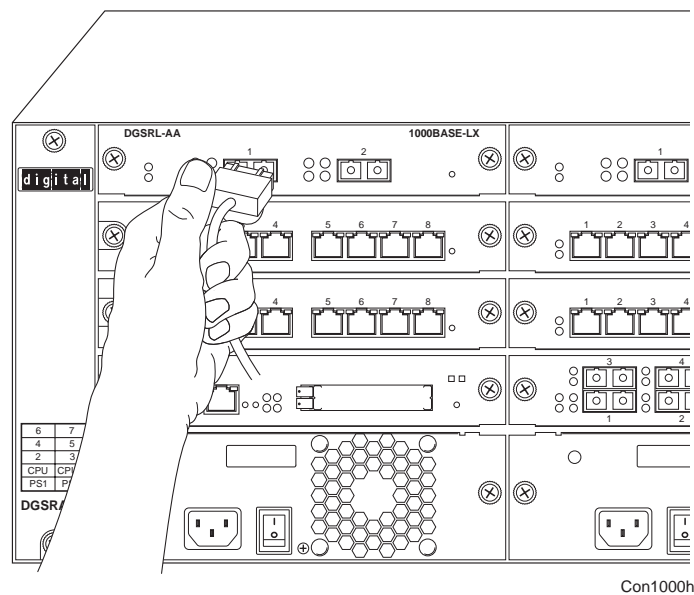

Figure 21. Plugging Ethernet cable into 100Base-FX line card port



**Figure 22. Plugging Ethernet cable into 1000Base-SX line card port**

The 1000Base-SX line and 100Base-FX line cards use SC-style Media Interface Connectors (MICs) to attach to multimode fiber (MMF) cables.

To attach the segment cables to your 1000Base-SX or 100Base-FX line cards, obtain an MMF cable with an SC MIC and plug the MIC into the port connector. When you plug the other end of the cable into another device, ensure that the cable connected to the transmit port on the GSR is connected to the receive port on the other device. The receive port on the GSR should be connected to the transmit port on the other device.

### 1000Base-LX Line Card

The 1000Base-LX line card supports single-mode fiber (SMF) or multimode fiber (MMF). The installation instructions for the 1000Base-LX line card are the same as the instructions for the 1000Base-SX line card.



# Chapter 3

## Software Installation and Setup

This chapter provides the following software installation and basic setup procedures:

- Installing the PCMCIA flash card (if you are upgrading from the software version on the DIGITAL GIGAswitch/Router's boot flash)
- Powering on the GSR and booting the software
- Starting the Command Line Interface (CLI)
- Using the CLI to add an IP interface, subnet mask, and default gateway for clearVISN CoreWatch access
- Setting up passwords
- Setting up an SNMP community string and trap target
- Setting the DNS server's IP address(es) and domain name
- Setting the SYSLOG server and message level
- Upgrading system image software
- Upgrading the boot PROM software
- Activating and saving configuration changes

### Installing a PCMCIA Flash Card

The Control Module PCMCIA flash card contains a version of the system image software which is installed at the factory. If you have a more recent system image and want to boot the GSR using the newer software, you must boot either from a PCMCIA card or from a TFTP server.

To install a PCMCIA card:

1. Power off the GSR. You cannot install or remove a PCMCIA card while the GSR is running.
2. Insert the PCMCIA card into either of the slots on the Control Module. You can choose either slot.

**Note:** Even though there are two slots on the Control Module, you cannot use two PCMCIA flash cards at the same time.

3. Lock the PCMCIA card into the slot by pushing the PCMCIA card all the way into the slot.
4. Power on the GSR. (See “Powering On and Booting the Software” on page 47.)
5. To verify proper installation of the PCMCIA card, do one of the following:
  - Reboot the system and watch the boot messages for the messages shown in bold type in the following example:

```

%SYS-I-FLASHCRD  Mounting 8MB Flash card
%SYS-I-FLASHMNTD 8MB Flash card mounted
%SYS-I-INITSYS    initializing system GSR 8
%SYS-I-DSCVMOD   discovered 'Control Module' module in slot CM
%SYS-I-DSCVMOD   discovered '10/100-TX' module in slot CM/1
%SYS-I-DSCVMOD   discovered '10/100-TX' module in slot 3
%SYS-I-DSCVMOD   discovered '10/100-TX' module in slot 4
%SYS-I-DSCVMOD   discovered '10/100-TX' module in slot 7
%SYS-I-INITPORT  initialized slot CM/1 port 1
%SYS-I-INITPORT  initialized slot CM/1 port 2
%SYS-I-INITPORT  initialized slot CM/1 port 3
%SYS-I-INITPORT  initialized slot CM/1 port 4
%SYS-I-INITPORT  initialized slot CM/1 port 5
%SYS-I-INITPORT  initialized slot CM/1 port 6
%SYS-I-INITPORT  initialized slot CM/1 port 7
%SYS-I-INITPORT  initialized slot CM/1 port 8
%SYS-I-INITPORT  initialized slot 3 port 1
%SYS-I-INITPORT  initialized slot 3 port 2
%SYS-I-INITPORT  initialized slot 3 port 3
%SYS-I-INITPORT  initialized slot 3 port 4
%SYS-I-INITPORT  initialized slot 3 port 5
%SYS-I-INITPORT  initialized slot 3 port 6
%SYS-I-INITPORT  initialized slot 3 port 7
%SYS-I-INITPORT  initialized slot 3 port 8

```

- Run the following command to display the boot log and look for the messages shown in the example above:

```
system show bootlog
```

**Note:** If the message “SYS-E-NOFLASHCARD” appears, the system has not detected a PCMCIA card. Check to ensure that the card is properly inserted, then reboot. If

the system still does not recognize the card, contact DIGITAL (See “Getting Help” on page xiii.)

## Powering On and Booting the Software

To power on the GSR and boot the software:

1. Make sure all exposed line card slots and power supply bays are free of foreign objects such as tools or your hands and are covered with coverplates.
2. Check the power supplies to make sure they are attached to your power source.
3. Turn the switch on each power supply to the ON position.
4. If this is the first time you have powered on the GSR, it will automatically try to boot using the software image in the Control Module’s boot flash.

While the software is booting, the amber Offline LED on the Control Module is lit. When the software finishes booting, the Offline LED goes dark and the green Online LED lights up, indicating that the GSR software is online. As the software boots, the management console attached to the Control Module’s DB-9 DCE port displays messages related to the phases of the boot sequence. When the software is fully booted, the following message appears on the management console:

```
Press RETURN to activate console...
```

5. As prompted, press Return (or Enter) to activate the CLI on the console.

## Starting the Command Line Interface

To start the Command Line Interface (CLI), power on the system. Startup messages appear on the console (the terminal attached to one of the Control Module’s ports).

After the software is fully booted and you press Return (or Enter) to activate the CLI, the CLI prompts you for a password. You can define separate passwords for login access, Enable mode, and Configure mode (defined below). The factory default password for all three is set to blank. (Simply press Return.)

## Access Modes

The GSR CLI has four access modes.

- **User** – Allows you to display basic information and use basic utilities such as ping but does not allow you to display SNMP, filter and access control list information or make other configuration changes. You are in User mode when the command prompt ends with the “>” character:

- **Enable** – Allows you to display SNMP, filter, and access control information as well as all the information you can display in User mode. To enter Enable mode, enter the **enable** command, then supply the password when prompted. When you are in Enable mode, the command prompt ends with the “#” character:
- **Configure** – Allows you to make configuration changes. To enter Configure mode, first enter Enable mode (**enable** command), then enter the **configure** command from the Enable command prompt. When you are in Configure mode, the command prompt ends with “(config)”.
- **Boot** – This mode appears when the GSR, the external flash card, or the system image is not found during bootup. You should enter the **reboot** command to reset the GSR. If the GSR still fails to bootup, please call DIGITAL Technical Support.

**Note:** The command prompt will show the name of the GSR in front of the mode character(s). The default name is “gs/r”. The procedure in “Setting Basic System Information” on page 49 describes how to change the system name.

When you are in Configure or Enable mode, use the **exit** command or press Ctrl+z to exit to the previous access mode.

**Note:** When you exit Configure mode, the CLI will ask you whether you want to activate the configuration commands you have issued. If you enter **Y** (Yes), the configuration commands you issued are placed into effect and the GSR’s configuration is changed accordingly. However, the changes are not written to the Startup configuration file in the Control Module’s boot flash and therefore are not reinstated after a reboot. See “Activating Configuration Changes and Saving the Configuration File” on page 61 for information about saving configuration changes.

## Basic Line Editing Commands

The CLI supports EMACs-like line editing commands. The following table lists some commonly used commands. For a complete set of commands, see the *DIGITAL GIGAswitch/Router User Reference Manual*.

Key sequence	Command
Ctrl+A	Move cursor to beginning of line
Ctrl+B	Move cursor back one character
Ctrl+D	Delete character
Ctrl+E	Move cursor to end of line
Ctrl+F	Move cursor forward one character

Key sequence	Command
Ctrl+N	Scroll to next command in command history (use the <b>cli show history</b> command to display the history)
Ctrl+P	Scroll to previous command in command history
Ctrl+U	Erase entire line
Ctrl+X	Erase from cursor to end of line
Ctrl+Z	Exit current access mode to previous access mode

## Setting Basic System Information

Use the procedure in this section to set the following system information:

- System time and date
- System name
- System location
- Contact name (the person to contact regarding this GSR)
- IP address for the management port on the Control Module.

**Note:** Some of the commands in this procedure accept a string value. String values can be up to a maximum of 255 characters in length including blank spaces. Surround strings that contain blanks with quotation marks (for example: “**string with internal blanks**”).

1. Enter the **enable** command to enter Enable mode in the CLI.
2. Enter the following commands to set the system time and date and then verify the setting:

```
system set date year <number> month <month-name> day <day>
             hour <hour> minute <minute> second <second>

system show date
```

Here is an example:

```
gs/r# system set date year 1998 month january day 19 hour 11 minute
      54 second 0
Time changed to: Mon Jan 19 11:54:00 1998
gs/r# system show date
Current time: Mon Jan 19 11:54:04 1998
```

3. Enter the **configure** command to enter Configure mode in the CLI. The following commands can be entered only from Configure mode.
4. Enter the following commands to set the system name, location, and contact information:

```
system set name "<string>"
system set location "<string>"
system set contact "<string>"
```

Here is an example:

```
gs/r(config)# system set name "gs/r"
gs/r(config)# system set location "Sunnyvale CA"
gs/r(config)# system set contact "Dan Cromwell"
```

5. Use the **interface add ip** command to set the IP address and netmask for the en0 Ethernet interface. The en0 Ethernet interface is used by the management port on the Control Module.

Here is an example:

```
gs/r(config)# interface add ip en0 address-netmask 10.50.11.22/16
```

**Note:** The en0 interface is automatically created by the system and is reserved for the management port on the Control Module.

6. When you enter commands in Configure mode, the GSR does not immediately execute the commands but instead checks the syntax of the commands and if they are syntactically correct stores them in the scratchpad, a temporary storage area in the memory. The scratchpad is cleared when you log out of the GSR, so you must activate the changes and then save them to the Startup configuration file to retain the changes, as explained below.

The scratchpad allows you to make configuration changes without worrying about the order in which you issue the commands. Also, if you change your mind about configuration changes you are making, you do not need to incrementally back out of the changes. You simply choose not to activate them. As you become more familiar with the GSR and the CLI and begin to make detailed configuration changes, you may find the scratchpad quite useful. For simple changes such as the ones in this procedure, you might instead want to activate the changes as you go, then use CLI commands to

view the results of the changes. To show the changes accumulated in the scratchpad, use the **show** command. (You must be in Configure mode.)

Here is an example:

```
gs/r(config)# show
-EDIT-I-NOCONFIG the running system has no configuration

***** Non-committed changes in Scratchpad *****
1*: system set name "gs/r"
2*: system set location "Sunnyvale CA"
3*: system set contact "Dan Cromwell"
```

7. To activate commands in the scratchpad such as the **set system** commands you entered in previous steps, enter the following command:

```
save active
```

The CLI displays the following message:

```
Do you want to make the changes Active (yes)?
```

8. Enter **yes** to activate the changes.

**Note:** If you exit Configure mode (by entering the **exit** command or pressing Ctrl+Z), the CLI will ask you whether you want to make the changes in the scratchpad active.

9. To display the active configuration, run the following command:

```
system show active-config
```

Here is an example:

```
gs/r# system show active-config
Running system configuration:
!
! Last modified from Console on Mon Jan 19 11:55:35 1998
!
1 : system set name "gs/r"
2 : system set location "Sunnyvale CA"
3 : system set contact "Dan Cromwell"
```

10. Changes in the active configuration take effect on the running system but will not be restored following a reboot. To ensure that changes are restored following a reboot, you must save the active database to the Startup configuration file using the following command:

```
copy active to startup
```

11. You must exit back to Enable mode to run the command. (Alternatively, you can enter the **save startup** command.)
12. The CLI displays the following message:

```
Are you sure you want to overwrite the Startup configuration?
```

13. Enter **yes** to add the active configuration to the Startup configuration file.

See “Activating Configuration Changes and Saving the Configuration File” on page 61 for more information about the scratchpad, active database, and Startup configuration.

## Setting Up SNMP Community Strings

To use SNMP to manage the GSR, you need to set up an SNMP community on the GSR. Otherwise, the GSR’s SNMP agent runs in local trap process mode unless you disable it using the **snmp stop** command. In addition, if you want to be able to access the SNMP traps issued by the GSR’s SNMP agent, you need to specify the IP address of the target for the SNMP traps.

Use the following procedure to add the SNMP community string and specify the target for traps.

1. Ensure that you are in Enable mode by entering the **enable** command in the CLI.
2. Ensure that you are in Configure mode by entering the **configure** command in the CLI.
3. Enter the following commands to add an SNMP community string set a target for the traps.

```
snmp set community <community-name> privilege read
snmp set target <IP-addr> community <community-name>
```

**Note:** The target IP address must be locally attached to the GSR. You cannot specify a target that is connected to the GSR by another router. If the IP address is more than one hop away from the GSR, configure the GSR with a static route to the target so that a cold start trap is sent.

4. Enter the **show** command to examine the command you have just entered into the scratchpad.
5. Enter the **save active** to activate the commands you entered in the previous steps.
6. To verify the changes, enter the **snmp show all** command.



Here is an example of the commands and output for configuring SNMP and saving the changes.

```

gs/r# config
gs/r(config)# snmp set community public privilege read-only
gs/r(config)# snmp set target 10.50.11.12 community public
gs/r(config)# save active
gs/r(config)# exit
gs/r# snmp show all
SNMP Agent status:
    enabled mode
SNMP Last 2 Clients:
10.50.100.53   Mon Mar 30 10:31:27 1998
10.50.100.43   Mon Mar 30 10:31:22 1998

SNMP Chassis Identity:
not configured.

Trap Table:
Index Trap Target Addr   Community String   Status
----- none configured -----

Traps by Type:
Authentication trap: enabled
Link Up/Down   trap: enabled

Community Table:
Index Community String           Privilege
1.    public                       READ-WRITE

SNMP statistics:
    247019 packets received
        246346 get requests
        745 get-next requests
        184 get-bulk requests
        50 set requests
        0 bad SNMP versions
        1 bad community names
        0 ASN.1 parse errors
        0 PDUs too big
    247018 packets sent
        246346 get responses
        745 get-next responses
        184 get-bulk responses
        50 set responses

```

- After verifying the SNMP configuration, save the changes to the Startup configuration file by entering the following command:

```
copy active to startup
```

Remember to answer “yes” when the CLI asks you whether you want to overwrite the Startup configuration.

## Setting Up Passwords

You can password protect CLI access to the GSR by setting up passwords for login access and Enable mode access. Users who have a login password but not an Enable password can use only the commands available in User mode. Users with an Enable password can use commands available in the Enable and Configure modes as well as the commands in User mode.

In addition, you can set up the GSR for TACACS, TACACS+, and/or RADIUS authentication on login and password by a TACACS or RADIUS server. Procedures for configuring the GSR for TACACS and RADIUS can be found in the *DIGITAL GIGAswitch/Router User Reference Manual*.

**Note:** If a password is configured for Enable mode, the GSR prompts for the password when you enter the **enable** command. Otherwise, the GSR displays a message advising you to configure an Enable password, then enters Enable mode. From Enable mode, you can access Configure mode to make configuration changes.

The default password for each access level is blank. (Simply press Enter or Return without entering a password.) If you want to add password protection to the CLI, use the following procedure.

1. Ensure that you are in Enable mode by entering the **enable** command in the CLI.
2. Ensure that you are in Configure mode by entering the **configure** command in the CLI.
3. Enter the following command for each password you want to set:

```
system set password login|enable <string>|none
```

4. Enter the **show** command to examine the commands you just entered.
5. Enter the **save active** command to activate the commands.
6. Enter the **system show active-config** command to verify the active changes.

Here is an example of the commands in the previous steps:

```

gs/r(config)# system set password login demo
gs/r(config)# system set password enable demo
gs/r(config)# save active
gs/r# exit
gs/r# system show active-config

Running system configuration:
!
! Last modified from Console on Mon Jan 19 12:12:19 1998
!
 1 : system set name "gs/r"
 2 : system set location "Sunnyvale CA"
 3 : system set contact "Dan Cromwell"
 4 : system set hashed-password login jNIssH c976b667e681d03ccd5fc527f219351a
 5 : system set hashed-password enable zcGzb0 5d1f73d2d478ceaa062a0b5e0168f46a
 6 : snmp set community public privilege read
 7 : snmp set target 10.50.11.12 community public

```



**Caution:** Test all the new passwords before saving the active configuration to the Startup configuration file. As shown in the example above, the passwords are shown in the active configuration in an encrypted format and will also appear this way in the Startup configuration.

To keep your passwords secure, the GSR does not have a command for displaying passwords. If you forget a password, you can remove the password by entering the following command while in Configure mode. (See the *DIGITAL GIGAswitch/Router Command Line Interface Reference Manual* for more information.)

```
system set password login|enable none
```

## Setting the DNS Domain Name and Address

If you want the GSR to be able to access a DNS server, use the following procedure to specify the domain name and IP address for the DNS server.

1. Ensure that you are in Enable mode by entering the **enable** command in the CLI.
2. Ensure that you are in Configure mode by entering the **configure** command in the CLI.

3. If you have not done so already, use the **interface add ip** command to set the IP address and netmask for the en0 Ethernet interface. The en0 Ethernet interface is used by the management port on the Control Module.

Here is an example:

```
gs/r(config)# interface add ip en0 address-netmask 10.50.11.22/16
```

**Note:** The en0 interface is automatically created by the system and is reserved for the management port on the Control Module.

4. Use the **ping** command to verify that the GSR can reach the DNS server by pinging the server:

Here is an example:

```
gs/r# ping 10.50.11.12
PING 10.50.11.12 (10.50.11.12): 56 data bytes
64 bytes from 10.50.11.12: icmp_seq=0 ttl=255 time=0 ms

--- 10.50.11.12 ping statistics ---

1 packets transmitted 1 packets received 0% packet loss
round-trip min/avg/max = 0/0/0 ms
```

5. Enter the following command to specify the domain name for which the DNS server(s) have authority:

```
system set dns domain <domain-name>
```

where <domain-name> is the domain name (example: **digitalsys.com**).

6. Enter the following command to “add” the DNS server to the GSR:

```
system set dns server <IP-addr>[ <IP-addr>[ <IP-addr>]]
```

where <IP-addr> is the IP address of the DNS server. You can specify up to three DNS servers. Separate the server IP addresses with commas.

7. Enter the **save active** command to activate the commands and enter **yes** to activate the changes.

Here is an example of the commands above:

```
gs/r# config
gs/r(config)# system set dns domain "mktg.digital.com"
gs/r(config)# system set dns server 10.50.11.12
gs/r(config)# save active
```

8. Enter the **system show dns** command to verify the new DNS settings:

Here is an example:

```
gs/r# system show dns
DNS domain: digital.com  DNS server(s): 10.50.11.12
```

9. Use the **ping** command to verify that the GSR can resolve the DNS server name into its IP address:

Here is an example:

```
gs/r# ping gsr1
PING gsr1.mktg.digital.com (10.50.11.22): 56 data bytes
64 bytes from 10.50.11.22: icmp_seq=0 ttl=255 time=0 ms

--- gsr1.mktg.digital.com ping statistics ---
1 packets transmitted 1 packets received 0% packet loss
round-trip min/avg/max = 0/0/0 ms
```

## Setting the SYSLOG Parameters

The CLI can use SYSLOG messages to communicate the following types of messages to a SYSLOG server:

- **Fatal** – Provide information about events that caused the GSR to crash and reset.
- **Error** – Provide information about errors.
- **Warning** – Provide warnings against invalid configuration information and other conditions that are not necessarily errors. This is the default.
- **Informational** – Provide informational messages such as status messages. The SYSLOG messages that the Control Module displays while booting the software and reading the startup configuration file are examples of Informational messages.

The GSR writes the SYSLOG messages to a SYSLOG daemon on UDP port 514. You can set the CLI to send all or only some of the message types. By default, the CLI sends warning, error, and fatal messages but not informational messages to the specified SYSLOG server.

Use the following procedure to specify the SYSLOG server and the types of messages you want the CLI to log on the server.

1. Ensure that you are in Enable mode by entering the **enable** command in the CLI.
2. Use the **ping** command to verify that the GSR can reach the SYSLOG server by pinging the server:
3. Ensure that you are in Configure mode by entering the **configure** command in the CLI.

4. Enter the following commands to “add” the SYSLOG server to the GSR, set the message level, and set the SYSLOG facility:

```
system set syslog server <hostname-or-IP-addr>
system set syslog level fatal|error|warning|info
system set syslog facility <facility-type>
```

Here is an example:

```
gs/r# config
gs/r(config)# system set syslog server 10.50.11.12
gs/r(config)# system set syslog level info
gs/r(config)# system set syslog facility local0
```

5. Enter the **show** command to show the commands you just entered. Because you have not activated these configuration changes yet, they are listed in the scratchpad section of the **show** output. Here is an example. Notice that the other configuration changes made during this CLI session also are listed. Active changes are listed in the “Running system configuration section” and unactivated changes are listed in the “Non-committed changes in Scratchpad” section.

```
gs/r(config)# show
Running system configuration:
!
! Last modified from Console on Mon Jan 19 12:37:21 1998
!
 1 : interface add ip en0 address-netmask 10.50.11.22/16
!
 2 : system set dns server 10.50.11.12
 3 : system set dns domain mktg.cabletron.com
 4 : system set name "gs/r"
 5 : system set location "Sunnyvale CA"
 6 : system set contact "Dan Cromwell"
 7 : system set hashed-password login jNIssH
c976b667e681d03ccd5fc527f219351a
 8 : system set hashed-password enable zcGzb0
5d1f73d2d478ceaa062a0b5e0168f46a
!
 9 : snmp set community public privilege read
10 : snmp set target 10.50.11.12 community public

***** Non-committed changes in Scratchpad *****
1*: system set syslog server 10.50.11.12
2*: system set syslog level info
3*: system set syslog facility local0
```

6. To activate the SYSLOG commands, enter the **save active** command. Enter **yes** to activate the changes.

## Loading System Image Software

By default, the GSR boots using the system image software installed on the Control Module's PCMCIA flash card. To upgrade the system software and boot using the upgraded image, use the following procedure.

1. Display the current boot settings by entering the **system show version** command:

Here is an example:

```
gs/r# system show version
Software Information
  Software Version   : 2.0.0.0
  Copyright          : Copyright (c) 1996-1998 Cabletron Systems Inc.
  Image Information  : Version 2.0.0.0 built on Fri Jan 26 16:46:39 1998
  Image Boot Location: file:/pc-flash/boot/gsr
  Boot Prom Version  : prom-1.0
```

**Note:** In this example, the location "pc-flash" indicates that the GSR is set to use the factory-installed software on the flash card.

2. Copy the software upgrade you want to install onto a TFTP server that the GSR can access. (Use the **ping** command to verify that the GSR can reach the TFTP server.)
3. Enter the following command to copy the software upgrade onto the PCMCIA flash card in the Control Module:

```
system image add <IPaddr-of-TFTP-host> <image-file-name>
```

Here is an example:

```
gs/r# system image add 10.50.11.12 GSR2000
Downloading image 'GSR2000' from host '10.50.11.12'
to local image GSR2000 (takes about 3 minutes)
kernel: 100%
Image checksum validated.
Image added.
```

4. Enter the **system image list** command to list the images on the PCMCIA flash card and verify that the new image is on the card:

Here is an example:

```
gs/r# system image list
Images currently available:
gsr8-1.0
```

5. Use the **system image choose** command to select the image file the GSR will use the next time you reboot the switch.

Here is an example:

```
gs/r# system image choose GSR2000_10A9
Making image gsr8-2.0 the active image for next reboot
```

6. Enter the **system image list** command to verify the change.

**Note:** You do not need to activate this change.

## Loading Boot PROM Software

The GSR boots using the boot PROM software installed on the Control Module's internal memory. To upgrade the boot PROM software and boot using the upgraded image, use the following procedure.

1. Display the current boot settings by entering the **system show version** command:

Here is an example:

```
gs/r# system show version
Software Information
Software Information
Software Version   : 2.0
Copyright         : Copyright (c) 1996-1998 Cabletron Systems Inc.
Image Information  : Version 2.0.B.13 built on Wed Dec 16 22:49:07
1998
Image Boot Location: file:/pc-flash/boot/gsr8/
Boot Prom Version  : prom-1.0
```

**Note:** In this example, the location "pc-flash" indicates that the GSR is set to use the factory-installed software on the flash card.

2. Copy the software upgrade you want to install onto a TFTP server that the GSR can access. (Use the **ping** command to verify that the GSR can reach the TFTP server.)
3. Use the **system promimage upgrade** command to copy the boot PROM upgrade onto the internal memory in the Control Module:

Here is an example:

```
gs/r# system promimage upgrade 10.50.11.12 prom2
Downloading image 'prom2' from host '10.50.11.12'
to local image prom2 (takes about 3 minutes)
kernel: 100%
Image checksum validated.
Image added.
```

4. Enter the **system show version** command to verify that the new boot PROM software is on the internal memory of the Control Module.



## Activating Configuration Changes and Saving the Configuration File

The GSR uses three special configuration files:

- **Active** – The commands from the Startup configuration file and any configuration commands that you have made active from the scratchpad (see below).



**Caution:** The active configuration remains in effect only during the current power cycle. If you power off or reboot the GSR without saving the active configuration changes to the Startup configuration file, the changes are lost.

- **Startup** – The configuration file that the GSR uses to configure itself when the system is powered on.
- **Scratchpad** – The configuration commands you have entered during a management session. These commands do not become active until you explicitly activate them. Because some commands depend on other commands for successful execution, the GSR scratchpad simplifies system configuration by allowing you to enter configuration commands in any order, even when dependencies exist. When you activate the commands in the scratchpad, the GSR sorts out the dependencies and executes the command in the proper sequence.

### Activating the Configuration Commands in the Scratchpad

The configuration commands you have entered using procedures in this chapter are in the Scratchpad but have not yet been activated. Use the following procedure to activate the configuration commands in the scratchpad.

1. Ensure that you are in Enable mode by entering the **enable** command in the CLI.
2. Ensure that you are in Configure mode by entering the **configure** command in the CLI.
3. Enter the following command:

```
save active
```

The CLI displays the following message:

```
Do you want to make the changes Active? [y]
```

4. Enter **yes** to activate the changes.

**Note:** If you exit Configure mode (by entering the exit command or pressing Ctrl+Z), the CLI will ask you whether you want to make the changes in the scratchpad active.

## Saving the Active Configuration to the Startup Configuration File

After you save the configuration commands in the scratchpad, the Control Module executes the commands and makes the corresponding configuration changes to the GSR. However, if you power off or reboot the GSR, the new changes are lost. Use the following procedure to save the changes into the Startup configuration file so that the GSR reinstates the changes when you reboot the software.

1. Ensure that you are in Enable mode by entering the **enable** command in the CLI.
2. Enter the following command to copy the configuration changes in the Active configuration to the Startup configuration:

```
copy active to startup
```

3. When the CLI displays the following message, enter **yes** to save the changes.

```
Are you sure you want to overwrite the Startup configuration? [n]
```

**Note:** You also can save active changes to the Startup configuration file from within Configure mode by entering the **save startup** command.

The new configuration changes are added to the Startup configuration file stored in the Control Module's boot flash.

## Viewing the Current Configuration

If you want to view the current configuration:

1. Ensure that you are in Enable mode by entering the **enable** command in the CLI.
2. Enter the following command to display the status of each command line:

```
system show active-config
```

The CLI displays the active configuration file with the following possible annotations:

- Commands without errors are displayed without any annotation.
- Commands with errors are annotated with an "E".
- If a particular command has been applied such that it can be expanded on additional interfaces/modules, then it is annotated with a "P". For example, if you enabled stp on all ports in the current system, however, the GSR contains only 1 module, then that particular command could be expanded at a later date when more modules have been added to the GSR.

A command like **stp enable et.\*.\*** would be displayed as follows:

```
P: stp enable et.*.*
```

indicating that it is only partially applied. If you add more modules to the GSR at a later date and then update the configuration file to encompass all of the available modules in the GSR, then the "P:" portion of the above command line would disappear when displaying this configuration file.

If a potentially partial command, which was originally configured to encompass all of the available modules on the GSR, becomes only partially activated (after a hotswap or some such chassis reconfiguration), then the status of that command line will automatically change to indicate a partial completion status, complete with "P:".

**Note:** Commands with no annotation or annotated with a "P:" are not in error.



# Chapter 4

## Installing and Starting DIGITAL clearVISN CoreWatch

This chapter:

- Provides an overview to DIGITAL clearVISN CoreWatch, which is the Java graphical user interface (GUI) you can use to monitor and configure your DIGITAL GIGAswitch/Router
- Discusses the browser and hardware requirements of clearVISN CoreWatch
- Explains installing the clearVISN CoreWatch software
- Describes starting clearVISN CoreWatch

### What Is DIGITAL clearVISN CoreWatch?

DIGITAL's clearVISN CoreWatch is a comprehensive, easy-to-use, network management and device configuration application for GSRs. Based on Java, clearVISN CoreWatch provides configuration, monitoring, and reporting capabilities with the assistance of wizards and drag-and-drop operations. It makes tasks such as configuring routers, VLANs, security filters, and setting up application level QoS policies simple and easy.

The clearVISN CoreWatch management features include:

- Java-based GUI
- Simplified routing configuration made easy
- Intuitive QoS management

- Configuration of security filters and ACLs
- Drag-and-drop VLAN setup and administration
- Extensive performance monitoring
- Comprehensive configuration through wizards or drag and drop
- Detailed HTML-based reporting

## System Requirements

DIGITAL clearVISN CoreWatch can run in a UNIX, Windows NT, and Windows 95 environments. As shown in the following table, clearVISN CoreWatch's system requirements depend on your operating system. The table identifies which browser to use with each operating system and gives the minimum hardware requirements for each environment.

	UNIX (Solaris 2.5.1 or 2.6)	Windows NT 4.0x	Windows 95
Browser	Netscape Navigator 3.0 or above	Netscape Navigator 3.0 or above, or Microsoft Internet Explorer 4.0 or above	Netscape Navigator 3.0 or above, or Microsoft Internet Explorer 4.0 or above
CPU	Sparc20 or above	Pentium 133 or above	Pentium 133 or above
RAM	128 MB	64 MB	64 MB
Disk	40 MB Free	20 MB Free	20 MB Free

## Installing DIGITAL clearVISN CoreWatch

You may install clearVISN CoreWatch on a UNIX (Solaris 2.5.1, Solaris 2.6), Windows NT, or Windows 95 system. How you install clearVISN CoreWatch depends on your environment. Separate discussions on installing clearVISN CoreWatch in the UNIX or Windows environments follow.

### Installing on a Solaris System

To install clearVISN CoreWatch from a CD onto a Solaris 2.5.1 or 2.6 system:

1. If you plan to integrate clearVISN CoreWatch with HP OpenView, be sure the HP OpenView daemon is running. For details, see your HP OpenView documentation.
2. Insert the clearVISN CoreWatch CD into your CD-ROM drive.

3. Log in as super user by entering the following command:

```
su - root
```

4. Run the clearVISN CoreWatch installation script by entering the following command:

```
install.sh
```

clearVISN CoreWatch is installed in on your system in the /opt/cscw directory.

5. Add /opt/cscw/bin to your environment path.

For details on adding items to a path, see your UNIX documentation.

## Installing on a Windows NT or Windows 95 System

**Note:** You must have Admin privileges to install clearVISN CoreWatch on a Windows NT system.

To install clearVISN CoreWatch on a Windows NT or Windows 95 system:

1. If you plan to integrate clearVISN CoreWatch with HP OpenView on a Windows NT system, be sure the HP OpenView daemon is running. For details, see your HP OpenView documentation.
2. Insert the clearVISN CoreWatch CD into your CD-ROM drive.
3. After the clearVISN CoreWatch installation wizard appears, click Next.
4. After reviewing the license agreement, click Yes to accept it.
5. Enter your name and your company's name in the appropriate text boxes. Then click Next.
6. Specify the folder in which you want to install the software and click Next.  
You can keep the default folder or click Browse and then browse to another folder.
7. Set up how you want to install clearVISN CoreWatch by doing one of the following:
  - Choose Typical to install the most common options.
  - Choose Compact to install the minimum files needed to run clearVISN CoreWatch.
  - Choose Custom and click Next if you are an advanced user and want to specify which files to install. Options with a check mark will be installed. Click to the left of an item to select or clear its check box.
8. Click Next.
9. Specify a name for the clearVISN CoreWatch program group, which is Cabletron CoreWatch by default. Then click Next.

10. When the browser window reappears, close it.
11. Specify whether you want to view the clearVISN CoreWatch readme file. Then click Finish.

Options with a check mark will be performed. Click to the left of an item to select or clear its check box.

## Starting DIGITAL clearVISN CoreWatch

How you start clearVISN CoreWatch depends on whether you installed it in the UNIX or a Windows environment. If you integrate clearVISN CoreWatch with SPECTRUM or HP OpenView when installing clearVISN CoreWatch, you can start clearVISN CoreWatch from within SPECTRUM in UNIX and Windows NT or within HP OpenView in UNIX and Windows NT.

Separate discussions on starting clearVISN CoreWatch in the UNIX and Windows environments and starting it from within SPECTRUM or HP OpenView follow.

### Starting DIGITAL clearVISN CoreWatch in UNIX

To start clearVISN CoreWatch in the Solaris 2.5.1 or 2.6 environment:

1. Enter the following command at the UNIX prompt:

```
CoreWatch
```

If the CoreWatch command is not found, you can locate it in `/opt/cscw/bin`.

The Select GSR dialog box appears.

2. Enter the name or IP address, community string, and Login password of the GSR. If you do not know this information, see your network administrator.
3. Click OK.

### Starting clearVISN CoreWatch in Windows NT or Windows 95

To start clearVISN CoreWatch in the Windows NT or Windows 95 environment:

1. Choose the Start menu, select Programs, select Cabletron CoreWatch, and then select CoreWatch.

If you installed the program in a startup folder other than Programs/Cabletron CoreWatch, select that folder from the Start menu and then select CoreWatch

The Select GSR dialog box appears.



2. Enter the name or IP address, community string, and Login password of the GSR. If you do not know this information, see your network administrator.
3. Click OK.

## Starting clearVISN CoreWatch from within SPECTRUM Enterprise Manager

SPECTRUM Enterprise Manager is Cabletron Systems' flexible and scalable network management platform based on leading-edge, object-oriented, artificial intelligence technology. SPECTRUM, which is available on Solaris and Windows NT, provides a suite of bundled applications as well as additional optional applications. The GSR is modeled in SPECTRUM using the GIGASwRtr model type. The GSR can be Auto-Discovered or manually created in a SPECTRUM Topology View and then copied to an Organization and/or Location View.

To start clearVISN CoreWatch from within SPECTRUM:

1. Start SPECTRUM.
2. If you know the topology location for your GIGASwRtr model, proceed to that location. Otherwise, open the Find View by choosing the View menu, selecting New View, and then selecting Find. Select Model-Type Name and enter "GIGASwRtr" to display all the GIGASwRtr models or select Network Address to display a particular model.
3. Bring up the menu for the GIGASwRtr model and select CoreWatch.

This starts clearVISN CoreWatch using the GIGASwRtr model's network address and community name.

## Starting clearVISN CoreWatch from within HP OpenView 5.x

HP OpenView 5.x is network node management software for the UNIX and Windows NT environments. If HP OpenView is integrated with clearVISN CoreWatch, you may use HP OpenView to start clearVISN CoreWatch and recognize your GSRs. HP OpenView is automatically integrated with clearVISN CoreWatch when you install clearVISN CoreWatch while the HP OpenView daemon is running.

To start clearVISN CoreWatch from within HP OpenView:

1. Start HP OpenView.
2. Click a network node.
3. Choose the Misc menu and then select CoreWatch.

The Select GSR dialog box appears.

4. Enter the name or IP address, community string, and Login password of the GSR. If you do not know this information, see your network administrator
5. Click OK.

# Appendix A

## Troubleshooting

If you experience difficulty with the basic hardware or software setup procedures in this guide, check the following table to see whether the difficulty you are experiencing is described. If you find a description of the difficulty you are experiencing, try the resolution(s) recommended for the difficulty.

If the resolution does not remove the difficulty or the difficulty is not listed in this appendix, see “Getting Help” on page xiii for information about contacting DIGITAL or your reseller for technical support.

If You Experience This Difficulty...	Try this Remedy...
The GSR exhibits no activity (no LEDs are on, the fan module is not operating, and so on)	Make sure the power supply is installed and plugged into a power source and the power source is active. Also check to see whether the switch on the power supply is in the on position.
The power supply is installed but is not operating.	Check the power cable and the circuit to which the power supply is connected.
The fan module is not active.	Check the power cable and the circuit to which the power supply is connected.  If the green status LED on the power supply indicates that it is active, immediately power down the chassis, unplug the power supply, and contact DIGITAL or your reseller. The fan module may be improperly connected or damaged.

If You Experience This Difficulty...	Try this Remedy...
The Control Module is not active	<p>Check the power cable and the circuit to which the power supply is connected.</p> <p>If the power supply is working, make sure the Control Module is inserted all the way into the CPU slot in the chassis and the captive screws are screwed in. The Control Module must be in the CPU slot and not in a line card slot.</p>
On the GSR-16, no routing or switching is taking place	Make sure the switching fabric module is installed in the chassis. See “Installing the Switching Fabric Module (GSR-16 only)” on page 32 for instructions.
No line cards are active	Check the power cable and the circuit to which the power supply is connected.
A specific line card is inactive	Make sure the line card is inserted all the way into the chassis and the captive screws are screwed in.
The chassis LEDs indicate activity but you cannot tell what the GSR is doing	Make sure you have properly connected the primary Control Module to a management console and the console is powered on.
An older software version continues to boot instead of the newer version on a PCMCIA card or TFTP server	Use the procedure in “Loading System Image Software” on page 59 to configure the GSR to boot using newer software.
You are unable to access the configuration commands in the CLI	Enter the <b>enable</b> command to access the Enable mode, then enter the <b>configure</b> command to access the Configuration mode.
Configuration changes do not seem to be taking effect	Use the procedure in “Activating the Configuration Commands in the Scratchpad” on page 61 to activate the changes.
Configuration changes are not reinstated after a reboot	Use the procedure in “Saving the Active Configuration to the Startup Configuration File” on page 62 to save the configuration changes to the Startup configuration file.

If You Experience This Difficulty...	Try this Remedy...
clearVISN CoreWatch cannot access the GSR	<p>Use the procedure in “Setting Up SNMP Community Strings” on page 52 to add an IP interface to 10Base-T port on the Control Module.</p> <p>If you have already performed this procedure, make sure you have properly installed clearVISN CoreWatch and check the network connection between the clearVISN CoreWatch management station and the GSR.</p>
The GSR is not resolving DNS names	<p>Use the procedure in “Setting the DNS Domain Name and Address” on page 55 to set up DNS.</p> <p>If you have already performed this procedure, make sure you can use NS lookup on the DNS server to get the default domain.</p>
An SNMP manager cannot access the GSR	<p>Use the procedure in “Setting Up SNMP Community Strings” on page 52 to set up an SNMP community string and specify a target for SNMP traps.</p> <p>If you have already performed this procedure, enter the <b>snmp show all</b> command to check the SNMP settings.</p> <p>Use the <b>traceroute</b> and <b>ping</b> commands to verify that the GSR can reach the SNMP management station.</p>
You are unable to ping a certain host	<p>Create and add an IP or IPX interface for the host. See the <i>DIGITAL GIGAswitch/Router User Reference Manual</i> for information.</p>



# Index

## Numerics

- 1000BASE-LX line card 21
- 1000BASE-SX line card 19
  - cable installation 42
- 1000-Mbps port 19
- 100BASE-FX line card
  - cable installation 42
- 10Base-T management port 12
- 802.1p 7

## A

- active configuration 61
- address-based bridging 4
- agent 8
- application switching 6

## B

- backplane 11
- baud rate 12
- BGP-4 6
- booting 47
  - setting up 59, 60
- bridging 4
- browser
  - requirements 66

## C

- chassis 9
  - installation 28
  - powering on 47
- CLI 8
- CLI port 12
  - cable installation 36
- Command Line Interface 8
- configuration file 61
- contact name
  - setting 49
- Control Module 10, 12
  - installation 30

- LEDs 13
- management cables
  - installation 36
- NVRAM 12
- CoreWatch 8
  - features 65
  - installing
    - in UNIX 66–67
    - in Windows 67–68
  - linking with HP OpenView 69–70
  - linking with SPECTRUM Enterprise Manager 69
  - overview of 65
  - requirements 66
  - starting
    - in UNIX 68
    - in Windows 68
- CPU
  - requirements 66

## D

- damage
  - preventing 26
- date
  - setting 49
- DB-9 port 12
- default baud rate 12
- dialog boxes
  - Select GSR 69, 70
- disk
  - requirements 66
- DNS
  - setting up GSR access 55
- DVMRP 6

## E

- electrostatic discharge 26
- equipment damage
  - preventing 26
- ESD 26

## F

- fan module 11
- features 1
- filters 7
- flash card 13
- flow-based bridging 4
- flow-based switching 6

## H

- hardware
  - installation 25
  - overview 8
  - specifications 26
- HP OpenView 8

## I

- IGMP 6
- injury
  - avoiding 25
- installation
  - software 45
- installing
  - CoreWatch
    - in UNIX 66–67
    - in Windows 67–68
- IP address, community string 69, 70
- IP multicasting 6
- IP routing 5
- IPX RIP 6
- IPX routing 5
- IPX SAP 6
- ISO OSI model 3

## L

- L2 lookup table 4
- Layer-2 4
- Layer-2 VLANs 5
- Layer-3 5
- Layer-3 VLANs 5
- Layer-4 6
- LED
  - power supply 14
- LEDs 13
  - 10/100BASE-TX 15, 17
  - 1000BASE-LX 22
  - 1000BASE-SX 20
  - 100BASE-FX 19
- line card
  - installation 34

## linking

- HP OpenView 69–70
- SPECTRUM Enterprise Manager 69
- Login password 69, 70

## M

- management cables
  - installation 36
- management platforms 8
- memory
  - PCMCIA flash card 13
- messages
  - SYSLOG 57
- MIBs 8

## N

- networking layers 3
- NVRAM 12

## O

- OpenView
  - linking with CoreWatch 69–70
  - linking with SPECTRUM 69
- OSPF 6
- overview 1
  - hardware 8
  - software 4

## P

- packing list 27
- password
  - setting up 54
- passwords
  - Login 69, 70
- PCMCIA flash card 13
  - installation 45
- performance 1
- port
  - 1000-Mbps 19
    - cable installation 40
  - Gigabit 19
- port-based VLANs 5
- power supply 13, 14
  - installation 35
- powering on 47
- precautions 25
- protocol-based VLANs 5



**Q**

QOS 7  
Quality of Service 7

**R**

RAM  
    requirements 66  
requirements  
    browser 66  
    CoreWatch 66  
    hardware 66  
reset switch 12  
RIP 6  
    IPX 6  
routing 5  
RST switch 12

**S**

Safety information  
    laser vi  
safety precautions 25  
SAP 6  
scratchpad 61  
security 7  
    setting up passwords 54  
segment  
    cable installation 40  
segment cable  
    installation 40  
Select GSR dialog box 69, 70  
serial port 12  
SNMP 8  
    setting up 52  
software  
    booting 47  
    installation 45  
    overview 4  
Solaris 8  
specifications 26  
Spectrum 8  
starting  
    CoreWatch  
        in UNIX 68  
        in Windows 68  
Startup configuration 61  
statistics 8  
subnet VLANs 5  
SYS switch 12  
SYSLOG

    setting up 57  
system location  
    setting 49  
system name  
    setting 49  
system switch 12

**T**

TCP  
    Layer-4 flow 6  
TCP/UDP services 4  
time  
    setting 49  
trap 8  
troubleshooting 71

**U**

UDP  
    Layer-4 flow 6  
UDP services 4  
UNIX  
    CoreWatch requirements 66  
    starting CoreWatch in 68

**V**

verifying your shipment 27  
VLANs 5

**W**

warnings 25  
Window NT  
    installing CoreWatch in 67–68  
Windows 95  
    CoreWatch requirements 66  
    installing CoreWatch in 67–68  
    starting CoreWatch in 69  
Windows NT 8  
    CoreWatch requirements 66  
    starting CoreWatch in 69





**digital**