

DECrepeater 900GM

Installation and Configuration

Part Number: EK-DETTM-IN. B01

August 1994

This manual describes how to install and configure the DECrepeater 900GM module.

Revision/Update Information: This is a revised manual.

Copyright

August 1994

The information in this document is subject to change without notice and should not be construed as a commitment by Digital Equipment Corporation. Digital Equipment Corporation assumes no responsibility for any errors that may appear in this document.

Copyright © 1994 by Digital Equipment Corporation.
All rights reserved. Printed in U.S.A.

The postage-paid Reader's Comments form at the back of this document requests your evaluation of this document to assist us in preparing future documentation.

The following are trademarks of Digital Equipment Corporation: DEC, DEChub, DEChub ONE, DECndu, DECndu Plus, DECrepeater, Digital, HUBwatch, MultiSwitch, OpenVMS, ThinWire, ULTRIX, VAX, VMS, and the DIGITAL logo.

MS-DOS is a registered trademark of Microsoft Corporation.

FCC NOTICE — Class A Computing Device:

This equipment generates, uses, and may emit radio frequency energy. The equipment has been type tested and found to comply with the limits for a Class A computing device pursuant to Subpart J of Part 15 of FCC Rules, which are designed to provide reasonable protection against such radio frequency interference when operated in a commercial environment. Operation of this equipment in a residential area may cause interference; in which case, measures taken to correct the interference are at the user's expense.

VCCI NOTICE — Class 1 Computing Device:

This equipment is in the 1st Class category (information equipment to be used in commercial and/or industrial areas) and conforms to the standards set by the Voluntary Control Council for Interference by Data Processing Equipment and Electronic Office Machines aimed at preventing radio interference in commercial and/or industrial areas. Consequently, when used in a residential area or in an adjacent area thereto, radio interference may be caused to radios and TV receivers.

Read the instructions for correct handling.

CE NOTICE – Class A Computing Device:

Warning!

This is a Class A product. In a domestic environment this product may cause radio interference, in which case the user may be required to take adequate measures.

Achtung!

Dieses ist ein Gerät der Funkstörgrenzwertklasse A. In Wohnbereichen können bei Betrieb dieses Gerätes Rundfunkstörungen auftreten, in welchen Fällen der Benutzer für entsprechende Gegenmaßnahmen verantwortlich ist.

Attention!

Ceci est un produit de Classe A. Dans un environnement domestique, ce produit risque de créer des interférences radioélectriques, il appartiendra alors à l'utilisateur de prendre les mesures spécifiques appropriées.

Contents

Safety

Introduction	1
Features	1
Front Panel	3
Back Panel	4
Installing the Module	5
Removing the Module	8
Configuring the Module	9
Setup Port Description	9
Setup Port Device Cabling	9
Accessing the Setup Port	9
Start Redirect Mode	12
DECRepeater 900GM Installation Menu (DEChub ONE Options)	13
DECRepeater 900GM Installation Menu (DEChub 900 Options)	14
Description of Menu Options	15
LED Descriptions	35
Problem Solving Using the LEDs	37
Normal Powerup	37
Problem Solving	37

Contents (Cont.)

Connector Pin Assignments	40
Telco Connector	40
BN26U-03 Cable	41
H8571-J Adapter	42
H8575-A Adapter	42
AUI (15-pin D-Sub) Port Connector	43
Product Specifications	44
Associated Documents	46

Tables

1 The Downline Upgrade (DLU) Process	26
2 Module LED States	35
3 Problem Solving Using the LEDs	37
4 DECrepeater 900GM Operating Specifications	44
5 Acoustical Specifications	45

Safety

Any warning or caution that appears in this manual is defined as follows:

WARNING	Contains information to prevent personal injury.
CAUTION	Contains information to prevent damage to equipment.

VORSICHT	Enthält Informationen, die beachtet werden müssen, um den Benutzer vor Schaden zu bewahren.
ACHTUNG	Enthält Informationen, die beachtet werden müssen, um die Geräte vor Schaden zu bewahren.

DANGER	Signale les informations destinées à prévenir les accidents corporels.
ATTENTION	Signale les informations destinées à prévenir la détérioration du matériel.

AVISO	Contiene información para evitar daños personales.
PRECAUCIÓN	Contiene información para evitar daños al equipo.

Safety (Cont.)

CAUTION

This action deletes all configured settings and replaces them with factory default values. All configuration settings will be lost. [Page 16.]

ACHTUNG

Bei diesem Vorgang werden alle Konfigurationseinstellungen gelöscht und die Werkseinstellungen wieder eingesetzt. Alle Konfigurationsdaten gehen verloren.

ATTENTION

Cette action supprime tous les paramètres de configuration et les remplace par des valeurs prédéfinies. Tous les paramètres de configuration seront perdus.

PRECAUCIÓN

Esta intervención borrará todos los parámetros de configuración y los sustituirá por valores por defecto definidos de fábrica. Se perderán todos los parámetros de configuración.

Safety (Cont.)

CAUTION

If power is interrupted during Stage 3 of the DLU process, the firmware image can become corrupted. Do not turn off power to the unit or perform any action that can cause the unit to lose power during Stage 3 of the DLU process. [Pages 25, 27, and 30.]

ACHTUNG

Sollte während der Phase 3 des DLU-Prozesses eine Unterbrechung der Stromversorgung eintreten, kann das Firmwareprogramm zerstört werden. Aus diesem Grunde wird dringend empfohlen, Vorkehrungen zu treffen, daß während der Durchführung dieser Phase 3 die Systemeinheit weder ausgeschaltet noch die Stromversorgung unterbrochen werden kann.

ATTENTION

L'image du microprogramme risque d'être corrompue, en cas de coupure de courant au cours de l'étape 3 du processus DLU. Ne mettez pas l'unité hors tension et n'exécutez aucune action risquant d'entraîner une coupure d'alimentation au cours de cette étape.

PRECAUCIÓN

Si se interrumpe el suministro eléctrico durante la Etapa 3 del proceso DLU, puede dañarse la imagen del firmware. No se debe apagar la unidad ni realizar ninguna operación que pueda causar una interrupción del suministro de la unidad durante la Etapa 3 del mencionado proceso.

Introduction

The DECrepeater 900GM (also referred to in this manual as the module) is a full-height Ethernet repeater that provides 24 external 10BaseT ports and 1 external AUI port.

In this manual, the term Ethernet is Digital's term for its product compatibility with the ISO 8802-3/ANSI/IEEE 802.3 standards and the Ethernet standards for Carrier Sense Multiple Access with Collision Detection (CSMA/CD) local area networks (LANs).

To give your workgroup LAN media flexibility and connectivity, the module can be configured into a DEChub 900 MultiSwitch (also referred to in this manual as the DEChub 900). One or more DECrepeater 900GM modules (up to 8) can be installed into the DEChub 900. The module can also serve as a standalone unit when configured with a DEChub ONE docking station (see the *DEChub ONE Installation* manual).

When the module is installed into a DEChub 900 or into a DEChub ONE, the module's hot-swap capability allows you to install or remove the module without turning off power.

The front panel provides 24 10BaseT ports (on two 50-pin Telco connectors) and 1 attachment unit interface (AUI) port. The module's front panel light-emitting diodes (LEDs) indicate the operating status of the module, the ports, and the network.

Features





Your DECrepeater 900GM module includes the following features:

- Access to ThinWire 10Base2 segment in the DEChub 900 MultiSwitch or to the AUI port in the DEChub ONE docking station.
- Backplane access to multiple LANs through one of six flexible channels in the DEChub 900.
- Automatic module self-test at powerup.
- Port-level packet address security.
- Momentary LED cycle switch on the front panel enables you to observe one bank of Port State LEDs at a time.
- In-band Simple Network Management Protocol (SNMP) management.

Introduction (Cont.)

- Out-of-band management (OBM) using SNMP over Serial Line Internet Protocol (SLIP) through the OBM connector on the DEChub 900 or DEChub ONE docking station in addition to normal in-band management.
- Built-in SNMP agent supports the following management information bases (MIBs):
 - Internet Engineering Task Force (IETF) Repeater MIB (RFC 1516)
 - Ethernet-like Interface Type MIB (RFC 1398)
 - Digital Extended Repeater MIB
 - DEChub 900 Public Common MIB
 - MIB II (RFC 1213)
- Manageability using any generic SNMP management application that supports the MIBs listed above.
- Upgradeable device firmware (in nonvolatile Flash memory) using Trivial File Transfer Protocol (TFTP) with Digital's Network Device Upgrade (DECndu) Plus utility or through the setup port with any TFTP server.
- User-friendly advanced Graphical User Interface (GUI) manageability with Digital's HUBwatch Network Management Station (NMS) application.

Front Panel

- 1) **Power**  **LED** — Lights when the module has power.
 - 2) **Module OK**  **LED** — Lights when the module passes self-test. If the module fails self-test, the Module OK  LED remains off.
 - 3) **Network OK**  **# LED** — Indicates status of the back-plane ThinWire port on the DEChub 900 or of the AUI port on the DEChub ONE docking station.
 - 4) **Network Activity**  **→ LED** — Indicates network traffic level.
 - 5) **Port State LEDs** — The LEDs (labeled 1 through 12) show status of ports A1 to A12 or ports B1 to B12, depending on the state of the Bank Indicator LEDs.
 - 6) **Bank Indicator LEDs** — The LEDs (labeled **A** and **B**) light one at a time for a few seconds, indicating which connector, Telco-A or Telco-B, is currently displaying its port connection status on the 12 Port State LEDs.
 - 7) **AUI LEDs** — The AUI Power LED (labeled **I/O**) indicates that the AUI port has power to supply to an external medium attachment unit (MAU). The AUI Status LED (not labeled) indicates the status of the AUI network connection.
- NOTE:** For more information about the module's LEDs, refer to the section titled LED Descriptions.
- 8) **Momentary LED cycle switch** — Stops and starts the LED status scanning of the Bank Indicator LEDs during operation.
 - 9) **Ethernet AUI (15-pin D-Sub) port connector** — connects to an external MAU directly or by using an AUI cable. Refer to the *OPEN DECconnect Applications Guide* for a list of AUI media adapters you can use with your module.
 - 10) **Telco connectors** — Two 50-pin connectors, Telco-A and Telco-B, each providing 12 ports.

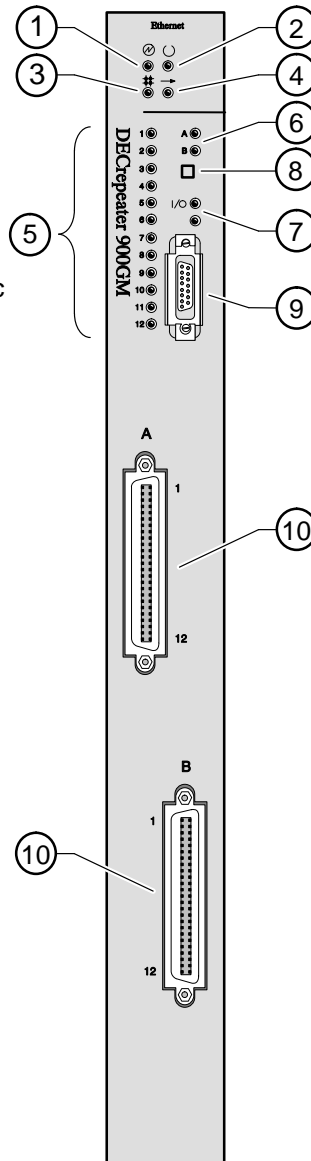

LKG-8758-931

Back Panel

- 1) **Locking tab** — Locks the module into a DEChub 900 backplane or into a DEChub ONE docking station. It also contains the hot-swap switch lever.
- 2) **48-pin connector** — Provides network and power connections to the module when the module is installed into a DEChub 900 or DEChub ONE docking station.
- 3) **Grounding bolt** — Provides a chassis grounding connection between the module and a DEChub 900 or a DEChub ONE docking station.
- 4) **Manufacturing label** — Lists the module part number, serial number, revision level, and power requirements.
- 5) **160-pin connector** — Provides network and power connections to the module when the module is installed into a DEChub 900 or a DEChub ONE docking station.
- 6) **Mounting tab** — Secures the module to the backplane when the module is installed into a DEChub 900 or a DEChub ONE docking station.
- 7) **Grounding fingers** — Provides additional chassis grounding between the module and a DEChub 900 or a DEChub ONE docking station.
- 8) **Address label** — Contains the module's 48-bit Ethernet Hardware Address.

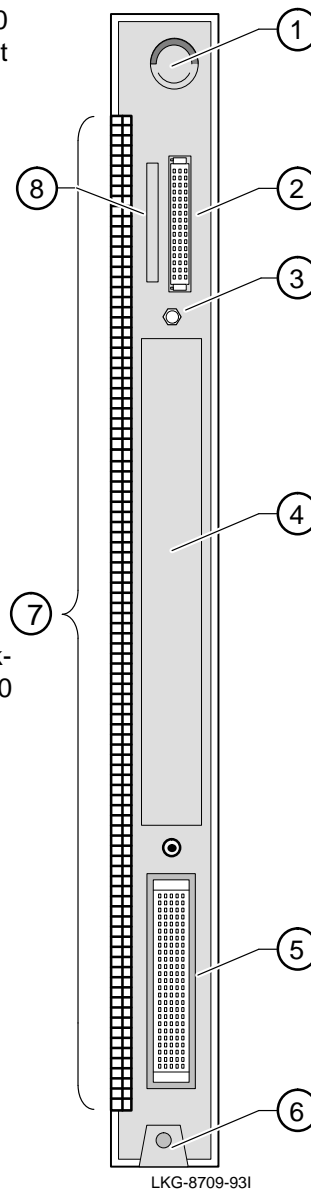

Installing the Module

The module hot-swap feature allows you to install the module into the DEChub 900 or DEChub ONE docking station without turning off power. Seating the module initiates the powerup sequence if enough power is available.

- 1 Compare your module's power requirements with the values shown in the Hub Manager status display (see examples).

If any of the module's power requirements exceed the values shown in the status display, add another power supply (see the *DEChub 900 MultiSwitch Owner's Manual*).

Module's Manufacturing Label (Example)

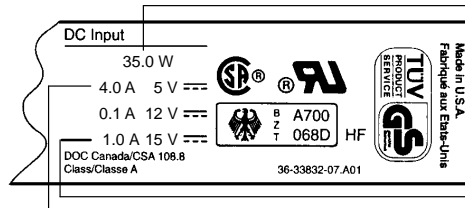

Hub Manager Status Display (Example)

Available: 90.5 W
5V: 13.0 A, 15V: 3.5 A

LKG-9346-94I



NOTE: The 12V power in the DEChub 900 is derived from the 15V power source. Although it is listed separately in the product specifications, the 12V requirements are included in the 15V power total.

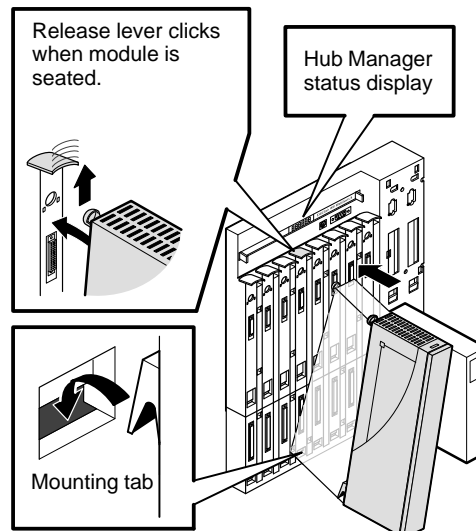

- 2 Seat the module into the DEChub 900.
 - a. Place the module's mounting tab into a mounting slot on the DEChub 900.
 - b. Pivot the module on the mounting tab and align the connectors.
 - c. Firmly push the module onto the backplane connectors until the release lever clicks.
 - d. Press down on the release lever to ensure that it is locked.



LKG-8711-93I

Installing the Module (Cont.)

3 Verify that the module's Power  LED lights immediately, and that the Module OK  LED lights within 1 minute.

- a. The Power  LED lights when power is applied, then the module performs a self-test.
- b. After the module completes self-test, the Module OK  LED lights and remains lit, then the Hub Manager status display shows:

```
DECrepeater 900GM  
up
```

NOTE: If the LEDs do not operate as described, refer to the section titled Problem Solving Using the LEDs.

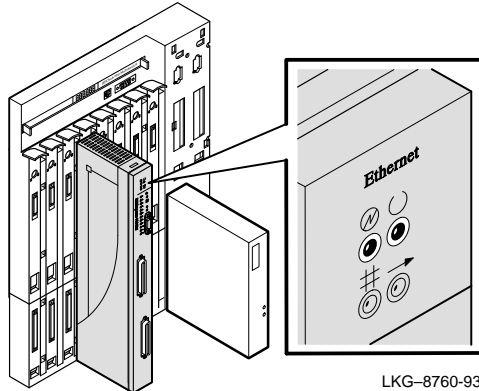

4 Connect the port cables.

Connect the two Telco cables and the AUI cable, then go to the section titled Configuring the Module. See your network manager if you are not sure which cables to connect.

NOTE: All cables should be installed, tested, and tagged at the site, prior to this installation.

- To connect the Telco cables, go to step 5.
- To connect the AUI cable, go to step 6.

Installing the Module (Cont.)

5 Connect the Telco cables.

- a. Insert the Telco plug into the Telco connector on the module.
- b. Using a flat-blade screwdriver, tighten the two screws at the ends of the plug.

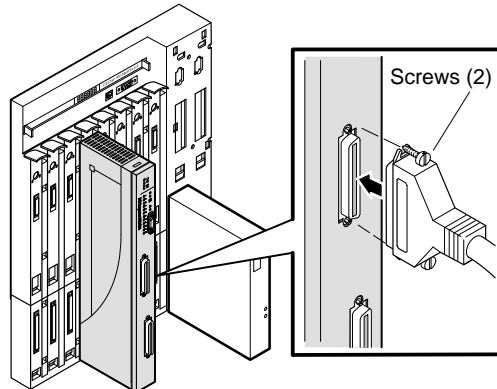

LKG-8761-93I

NOTE: To disconnect the Telco cables, use a flat-blade screwdriver to loosen the two screws at the ends of the plug, then disconnect the cable.

6 Connect the AUI cable.

- a. Push the module's AUI connector slide latch to the unlocked position.
- b. Insert the AUI cable plug into the AUI connector.
- c. Push the module's AUI connector slide latch to the locked position.

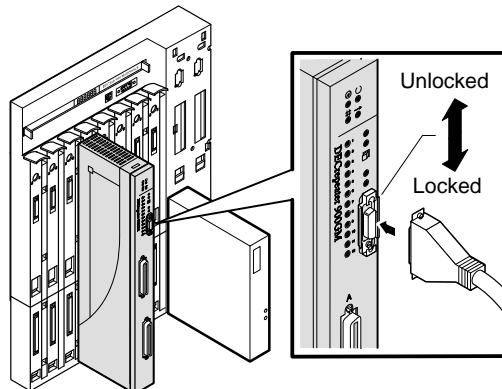

LKG-8762-93I

NOTE: To disconnect the cable, push the connector slide latch to the unlocked position, then disconnect the cable.

After all cables are installed, go to the section titled Configuring the Module.

Removing the Module

1 Disconnect all the cables from the module.

- a. To remove the AUI cable, push the connector slide latch to the unlocked position, then disconnect the cable.
- b. To remove the Telco cables, use a flat-blade screwdriver to loosen the two screws at the ends of the plugs, then disconnect the cables.

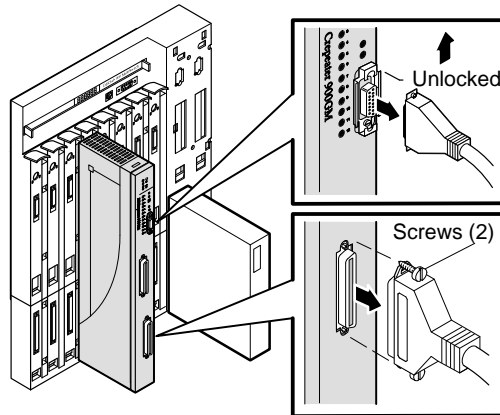

LKG-8763-931

2 Unseat the module from the DEChub 900.

- a. Lift the release lever located on the top of the DEChub 900 slot.
- b. Pivot the module back on its bottom mounting tab, and disengage the module from the backplane.

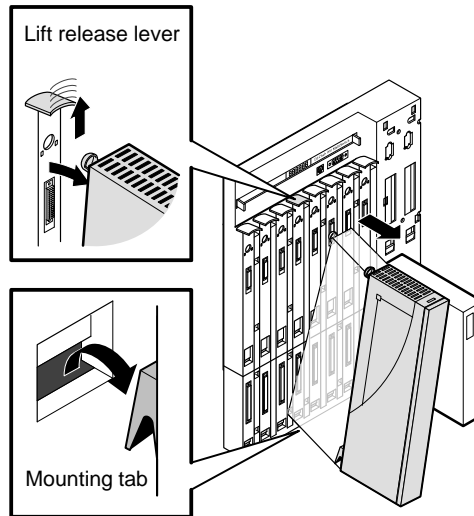

LKG-8717-931

Configuring the Module

Setup Port Description

The setup port (on the DEChub 900 MultiSwitch or the DEChub ONE docking station) allows you to access and set DECrepeater 900GM parameters. This section describes how to access the module from either port and set those parameters.

NOTE: The setup port screen displays illustrated in this manual may vary slightly from the actual screen displays on your setup port device.

The signals from the DEChub 900 Hub Manager setup port and from the DEChub ONE docking station setup port conform to the EIA-232D signaling standard at 9600 baud. To the user, the port appears as a data terminal equipment (DTE) device.

NOTE: Devices that use the EIA-423 signaling standard are compatible with the DEChub 900 Hub Manager setup port.

Setup Port Device Cabling

The setup port on the DEChub 900 MultiSwitch or the DEChub ONE docking station can be connected to a setup port device (a terminal or personal computer), using the following cables and adapters.

Cable/Adapter Type	Connecting Device
BN24H-xx ¹	A terminal with a 6-pin MMJ connector
BN24H-xx ¹ /H8575-A	A terminal with a 25-pin D-Sub connector
BN24H-xx ¹ /H8571-J	A PC with a 9-pin D-Sub communications port

¹ xx indicates cable length in meters.

Accessing the Setup Port

To access the setup port on the DECrepeater 900GM module, do the following:

1. Ensure that the transmit and receive baud rates on the setup port device are set to 9600 baud.
2. Connect the setup port device to the setup port connector on either the DEChub 900 or the DEChub ONE docking station (see illustration).

Configuring the Module (Cont.)

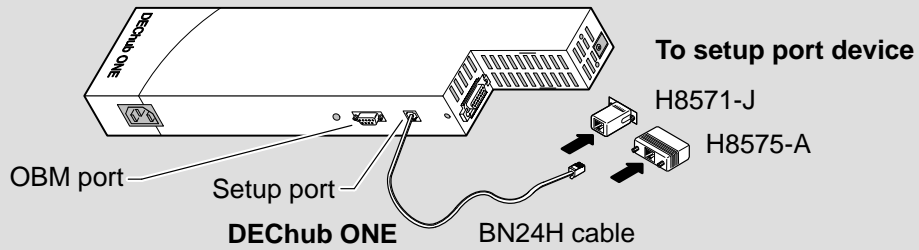
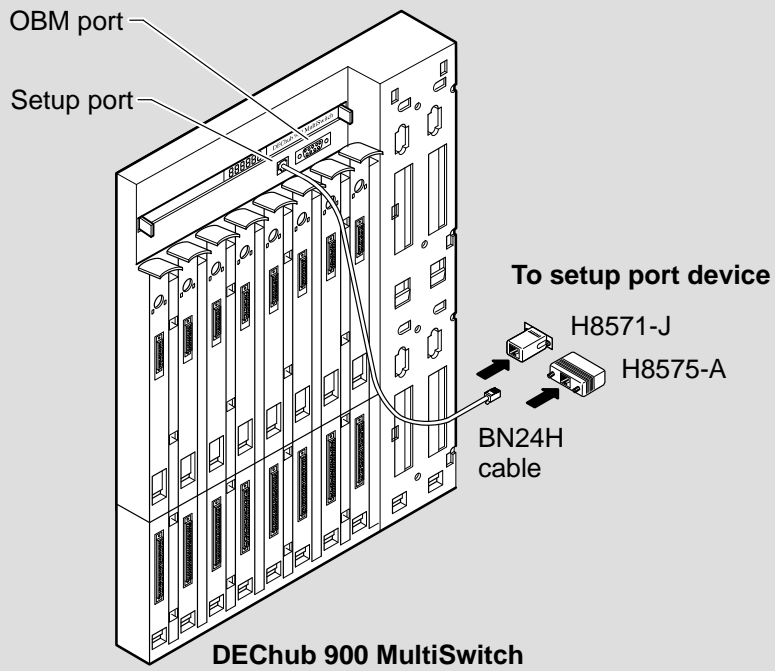

LKG-8718-93I

Configuring the Module (Cont.)

3. Press on the setup port device a few times until a menu appears.
 - a. If the module is connected to the setup port on the DEChub ONE docking station, the DECrepeater 900GM INSTALLATION MENU appears. Go to the section titled DECrepeater 900GM Installation Menu (DEChub ONE Options).
 - b. If the setup port device is connected to the Hub Manager setup port on the DEChub 900, the DEChub 900 MultiSwitch INSTALLATION MENU appears (see following example).

The following is an example of the DEChub 900 MultiSwitch INSTALLATION MENU:

```
DEChub 900 MultiSwitch
=====
DEChub 900 MultiSwitch INSTALLATION MENU

[1] Reset with Factory Defaults
[2] Reset with Current Settings
[3] Show Current Settings
[4] Set SNMP Read/Write Community
[5] Add SNMP Trap Addresses
[6] Delete SNMP Trap Addresses
[7] Dump Error Log
[8] Set In-Band Interface IP Address
[9] Downline Upgrade
[10] Set Out-of-Band Interface IP Address
[11] Set Out-of-Band Interface Port Speed
[12] Start Event Display Mode
[13] Start Redirect Mode
```

```
Enter selection : 13 
```

Choose option 13, then go to the section titled Start Redirect Mode.

The DECrepeater 900GM does not support Option [9] Downline Upgrade from this menu. You must choose Option [13] Start Redirect Mode to perform a downline upgrade to this module.

- c. Choose option 13, then go to the section titled Start Redirect Mode.

Configuring the Module (Cont.)

Start Redirect Mode

The `Start Redirect Mode` option redirects the DEChub 900 Hub Manager setup port to the setup port of any network module that supports this function (such as the DECrepeater 900GM) that is installed into the DEChub 900. Choosing this option allows you to configure or obtain status of an installed network module by accessing the specified network module's installation menu.

After you choose the `Start Redirect Mode` option from the DEChub 900 MultiSwitch INSTALLATION MENU, the screen prompts you for a slot number as shown in the following example.

The following example shows how to select a slot number (user response is shown in **boldface type**):

```
Enter selection: 13
=====
Enter the slot number for redirection (1-8): 3 
Setup port redirected to 3: DECrepeater 900GM
Attempting to connect ...
=====
Connection successful!
```

Enter the number of the slot where the module is installed.

After you press , the DECrepeater 900GM INSTALLATION MENU appears on your screen. Go to the section titled DECrepeater 900GM Installation Menu (DEChub 900 Options).

Configuring the Module (Cont.)

DECrepeater Installation Menu (DEChub ONE Options)

This section shows the options available from the DECrepeater 900GM INSTALLATION MENU when the module is installed into the DEChub ONE docking station.

The following is an example of the DECrepeater 900GM INSTALLATION MENU:

```
DECrepeater 900GM
=====
DECrepeater 900GM INSTALLATION MENU

[1] Reset with Factory Defaults
[2] Reset with Current Settings
[3] Show Current Settings
[4] Set SNMP Read/Write Community
[5] Add SNMP Trap Addresses
[6] Delete SNMP Trap Addresses
[7] Dump Error Log
[8] Set In-Band Interface IP Address
[9] Set In-Band Interface Default Gateway Address
[10] Downline Upgrade
[11] Set Out-of-Band Management (OBM)Interface IP Address
[12] Set Out-of-Band Management (OBM) Port Speed

-----
Enter selection : 1 
```

Choose an option, then go to the section titled Description of Menu Options.

If you need to assign an IP address to the module, choose this option.

Configuring the Module (Cont.)

DECrepeater Installation Menu (DEChub 900 Options)

This section shows the options available from the DECrepeater 900GM INSTALLATION MENU when the module is installed into the DEChub 900.

The following is an example of the DECrepeater 900GM INSTALLATION MENU:

```
DECrepeater 900GM slot 3
=====
DECrepeater 900GM INSTALLATION MENU

[1] Reset with Factory Defaults
[2] Reset with Current Settings
[3] Show Current Settings
[4] Set SNMP Read/Write Community
[5] Add SNMP Trap Addresses
[6] Delete SNMP Trap Addresses
[7] Dump Error Log
[8] Set In-Band Interface IP Address
[9] Set In-Band Interface Default Gateway Address
[10] Downline Upgrade

[Ctrl/C] Return to DEChub 900 MultiSwitch INSTALLATION MENU
=====
Enter selection : 1 Return
```

Indicates the DEChub 900 slot number where the module is installed.

Choose an option, then go to the section titled Description of Menu Options.

If you need to assign an IP address to the module, choose this option.

Configuring the Module (Cont.)

Description of Menu Options

This section describes the menu options that are available from the `DECRepeater 900GM INSTALLATION MENU`. Note that the out-of-band menu options apply to the module only when it is in standalone mode (configured in a DEChub ONE docking station).

[1] Reset with Factory Defaults

This option resets the module, causing **most** of the module's configured NVRAM parameters to be initialized to factory default values.

Following are some examples of the module's configured NVRAM parameters that are reset to factory defaults:

- SNMP read/write community — this name is reset to `PUBLIC`.
- SNMP trap addresses —all SNMP trap addresses are deleted.
- In-band interface IP address — this address is deleted.
- In-band interface default gateway address — this address is deleted.
- Out-of-band interface IP address — this address is deleted.
- Out-of-band interface port speed — reset to 9600.

Following are the **only** parameters that are **not** reset:

- Serial number
- Reset count
- Error log data

Configuring the Module (Cont.)

[1] Reset with Factory Defaults (Cont.)

CAUTION  This action deletes all configured settings and replaces them with factory default values. All configuration settings will be lost.

NOTE: Allow approximately 1 minute for the module to reset and complete self-test.

The following is an example of the dialog associated with this option (user response is shown in **boldface type**):

```
Enter selection : 1
DECrepeater 900GM - slot 3
=====
                        RESET WITH FACTORY DEFAULTS
* * * * *
*   IMPORTANT!           IMPORTANT!           IMPORTANT!   *
* * * * *
* This selection will delete the current configuration      *
* settings and reset the system with the factory default  *
* settings. All configuration settings will be lost.      *
* * * * *
=====

Press Y to confirm [N] : Return
Press Return for Main Menu ...
```

Configuring the Module (Cont.)

[2] Reset with Current Settings

This option resets the module but leaves the module's configured NVRAM parameters at their current values.

NOTE: Allow approximately 1 minute for the module to reset and complete self-test.

The following is an example of the dialog associated with this option (user response is shown in **boldface type**):

```
Enter selection : 2
DECrepeater 900GM - slot 3
=====
                RESET WITH CURRENT SETTINGS
This selection will reset your system with the
current configuration settings.
=====

Press Y to confirm [N] : Return
Press Return for Main Menu ...
```

Configuring the Module (Cont.)

[3] Show Current Settings

This option shows the module's current settings.

NOTE: If the module is being configured for the first time, some fields will be blank.

The following is an example of the display associated with this option:

```
Enter selection : 3
DECrepeater 900GM - slot 3
=====
DECrepeater 900GM, Ethernet Rptr SNMP, HW=v1,RO=v1,SW=v1.1
SysUpTime           : 01:39:11    14 resets
SNMP Read/Write Community : public
SNMP Trap Addresses  : Not Configured
Status of Last Downline Upgrade : No Status
                                00:00:44  28 resets
In-Band Interface Hardware Address : 08-00-2B-A3-4C-70
In-Band Interface IP Address       : 16.20.216.181
In-Band Interface Default Gateway Address : Not Configured
SNMP Port Traps           : Enabled
=====
Press Return for Main Menu ...
```

Configuring the Module (Cont.)

[4] Set SNMP Read/Write Community

This option prompts you to enter the module's read/write community name.

The format for a community name is a string consisting of 4 to 31 printable ASCII characters. This community name can be used by SNMP managers for read/write access control.

The following is an example of an SNMP read/write community name: `peterj1966`

The following is an example of the dialog associated with this option (user response is shown in **boldface type**):

```
Enter selection : 4
DECrepeater 900GM - slot 3
=====
                SET SNMP READ/WRITE COMMUNITY
Format: The format for a community name is a string,
        consisting of four to thirty-one printable ASCII
        characters, that describes the relationship between an
        SNMP agent and one or more SNMP managers. The string
        defines the authentication mechanism that is employed
        to validate the use of the community by the sending
        SNMP entity.
=====
Enter the community string [public] : peterj1966 
                SNMP Read/Write community string set.
                Press Return for Main Menu ...
```

Configuring the Module (Cont.)

[5] Add SNMP Trap Addresses

This option prompts you to enter IP addresses to which SNMP traps will be sent from the DECrepeater 900GM module.

The format for an SNMP trap address is the standard 4-octet dotted decimal notation, where each octet of the address is represented as a decimal value, separated by a decimal point (.).

The following is an example of an SNMP trap address: 16.20.54.156

The following is an example of the dialog associated with this option (user response is shown in **boldface type**):

```
Enter selection : 5
DECrepeater 900GM - slot 3
=====
      ADD SNMP TRAP ADDRESSES

Format: The standard 4 octet dotted decimal notation in which
        each octet of the address is represented as a decimal
        value, separated by a '.' character.

        example: 16.20.54.156

=====
Configured SNMP Trap Addresses: 16.20.216.81
Trap address [ ] : 16.20.54.156 Return
Trap address added! Add another? [none] : Return
      Press Return for Main Menu ...
```

Enter the SNMP trap address that you have chosen, then press Return.

Appears only if the module has been previously configured.

Configuring the Module (Cont.)

[6] Delete SNMP Trap Addresses

This option prompts you to select SNMP trap addresses for deletion.

The format for an SNMP trap address is the standard 4-octet dotted decimal notation, where each octet of the address is represented as a decimal value, separated by a decimal point (.).

The following is an example of an SNMP trap address: 16.20.54.156

The following is an example of the dialog associated with this option (user response is shown in **boldface type**):

```
Enter selection : 6
DECrepeater 900GM - slot 3
=====
          DELETE SNMP TRAP ADDRESSES
Format: The standard 4 octet dotted decimal notation in which
       each octet of the address is represented as a decimal
       value, separated by a '.' character.
       example: 16.20.40.156
=====
Configured SNMP Trap Addresses: 16.20.216.81
      Trap address [ ] : 16.20.216.81 
Trap address deleted. Delete another? [ ] : 
      Press Return for Main Menu ...
```

Enter the SNMP trap address that you have chosen for deletion, then press Return.

Appears only if the module has been previously configured.

Configuring the Module (Cont.)

[7] Dump Error Log

This option displays error log dumps for use by Digital support personnel when analyzing system faults. Up to four error log dumps can be stored, and the most recent dump is displayed first.

The following is an example of the display associated with this option:

```
Enter selection : 7
DECrepeater 900GM - slot 3
=====
                DUMP ERROR LOG
            CURRENT RESET COUNT: 14
=====
Entry #      = 3
Timestamp    =   0   0   791
Reset Count  = 13
Trap @315 in console_cfg.c   Backplane clock failure
Dump another entry Y/[N]? N 
=====
No more Error Log entries.

                Press Return for Main Menu ...
```

Configuring the Module (Cont.)

[8] Set In-Band Interface IP Address

This option prompts you to enter the module's IP address.

The format for an IP address is the standard 4-octet dotted decimal notation, where each octet of the address is represented as a decimal value, separated by a decimal point (.).

The following is an example of an IP address: 16.20.54.156

The following is an example of the dialog associated with this option (user response is shown in **boldface type**):

```
Enter selection : 8
DECrepeater 900GM - slot 3
=====
          SET IN-BAND INTERFACE IP ADDRESS
Format: The standard 4 octet dotted decimal notation in which
        each octet of the address is represented as a decimal
        value, separated by a '.' character.
        example: 16.20.40.156
To delete the IP address, enter 0 in the appropriate
address field.
=====
IP address [16.20.216.179] : 16.20.54.156 
          IP Address set
          Press Return for Main Menu ...
```

This cell data represents a previously set IP address. During the initial setup, this cell default will appear as [].

Enter the module's IP address, then press Return.

Configuring the Module (Cont.)

[9] Set In-Band Interface Default Gateway Address

This option prompts you for a default gateway IP address. The default gateway address is needed only to deliver traps to a management station that is not on the local subnet.

NOTE: The module does **not** need to be configured with a subnet mask for SNMP communications with a management station that is located on any subnet in the IP network.

The following is an example of a default gateway IP address: 16.07.80.156

The following is an example of the dialog associated with this option (user response is shown in **boldface type**):

```
Enter selection : 9
DECrepeater 900GM - slot 3
=====
SET IN-BAND INTERFACE DEFAULT GATEWAY ADDRESS
Format: The standard 4 octet dotted decimal notation in which
each octet of the address is represented as a decimal
value, separated by a '.' character.
example: 16.20.40.156
To delete the IP address, enter 0 in the appropriate
address field.
=====
Default Gateway address [] : 16.07.80.156 
Default Gateway Address set
Press Return for Main Menu ...
```

Enter the module's default gateway IP address, then press Return.

Configuring the Module (Cont.)

[10] Downline Upgrade

This option allows you to upgrade the module firmware (in nonvolatile Flash memory). It prompts you to enter the firmware image load filename and the IP address of your Trivial File Transfer Protocol (TFTP) load host.

Before initiating this option, be sure that the module that you are updating has been configured with an IP address. If the module is not configured with an IP address, select the `Set In-Band Interface IP Address` option (option [8]) from the `DECrepeater 900GM INSTALLATION MENU` to set an IP address.

Do not use the DEChub 900 MultiSwitch Hub Manager's IP address to upgrade the DECrepeater 900GM.

NOTE: The module's IP address is retained at the completion of the downline upgrade.

The following is an example of an firmware image load filename and an IP address:

`dettm110.bin` and `16.20.54.156`

When the screen prompts you to `Enter the Load Filename`, do the following:

- If the file is located in the default TFTP directory, enter only the filename.
- If the file is **not** located in the default TFTP directory, enter the complete pathname along with the filename.

The format of the firmware image load filename is specified according to the conventions used by your TFTP load host.

CAUTION  If power is interrupted during Stage 3 of the DLU process, the firmware image can become corrupted. Do not turn off power to the unit or perform any action that can cause the unit to lose power during Stage 3 of the DLU process.

The Downline Upgrade (DLU) Process

The DLU process consists of four stages:

- Stage 1 — Transferring Firmware Image
- Stage 2 — Verifying Firmware Image
- Stage 3 — Writing New Firmware Image into Nonvolatile Storage
- Stage 4 — Module Reset and Self-Test

The following table explains what happens during each stage of the DLU process:

Configuring the Module (Cont.)

[10] Downline Upgrade (Cont.)







Table 1 DLU Process Description

Stage	What Happens
1	<p>The new firmware image from the TFTP load host is transported across the network, and placed into a temporary storage buffer in the module.</p> <p>Indications that this stage is in progress include:</p> <ul style="list-style-type: none">• Module status — functional, but not manageable.• Module cannot respond to management requests.• LED display — the Power Ⓟ LED and the Module OK Ⓞ LED remain on. The #2 Port State LED lights.• HUB Manager display — DECrepeater 900GM unknown• Typical time to complete this stage — normally 1 minute. However, due to variances in network configurations (load path and traffic levels), this stage of the DLU process can take up to 10 minutes to complete.
2	<p>The module verifies that the firmware image is correct after Stage 1 is complete.</p> <p>Indications that this stage is in progress include:</p> <ul style="list-style-type: none">• Module status — functional, but not manageable.• Module cannot respond to management requests.• LED display — The Power Ⓟ LED and the Module OK Ⓞ LED remain on. The #2 Port State LED turns off. The #3 Port State LED lights.• HUB Manager display — DECrepeater 900GM unknown• Typical time to complete this stage — normally 10 seconds. <p>(continued on next page)</p>

Configuring the Module (Cont.)

[10] Downline Upgrade (Cont.)

Table 1 (Cont.) DLU Process Description

Stage	What Happens
3	<p>The new firmware image is transferred from the module's temporary storage buffer to the Flash RAM, overwriting the old firmware image.</p> <p>CAUTION  If power is interrupted during Stage 3 of the DLU process, the firmware image can become corrupted. Do not turn off power to the unit or perform any action that can cause the unit to lose power during Stage 3 of the DLU process.</p> <p>Indications that this stage is in progress include:</p> <ul style="list-style-type: none"> • Module status — functional, but not manageable. • Module cannot respond to management requests. • LED display — the Power  LED and the Module OK  LED remain on. The #3 Port State LED turns off. The #4 Port State LED lights. • HUB Manager display — DECrepeater 900GM unknown • Typical time to complete this stage — normally 30 seconds.
4	<p>The module resets, runs self-test, and then begins executing the new firmware image.</p> <p>Indications that this stage is in progress include:</p> <ul style="list-style-type: none"> • Module status — not functional during reset and self-test. • Module cannot respond to management requests. • LED display — the Power  LED remains on. The Module OK  and the #4 Port State LED turn off. The #5 Port State LED lights. All LEDs light momentarily. Then, all, except the Power  LED, turn off. • HUB Manager display — DECrepeater 900GM unknown • Typical time to complete this stage — normally 1 minute. <p>After the successful completion of self-test, the Module OK  LED turns on and the module becomes fully operational and manageable. Note also that the HUB Manager display indicates:</p> <p style="text-align: right;">DECrepeater 900GM up</p>

Configuring the Module (Cont.)

[10] Downline Upgrade (Cont.)

The following section explains how to use the DLU process. An expanded example of the setup screen display follows the description.

Using the DLU Process

Before initiating this option, be sure that the module that you are upgrading has been configured with an IP address. If the module is not configured with an IP address, select the `Set In-Band Interface IP Address` option (option [8]) from the `DECrepeater 900GM INSTALLATION MENU` to set an IP address.

Do not use the `DEChub 900 MultiSwitch Hub Manager's` IP address to upgrade the `DECrepeater 900GM`.

When you select the `Downline Upgrade` option (option [10]) from the `DECrepeater 900GM INSTALLATION MENU`, the initial setup screen display appears (see the following example display). This screen identifies the option and alerts users not to interrupt power during the downline load.

```
Enter selection : 10
DECrepeater 900GM

=====:

                DOWNLINE UPGRADE

This process upgrades the device's firmware (in
nonvolatile Flash memory). Enter the IP address of
your TFTP (Trivial File Transfer Protocol) load host
and the image file name when prompted.

* * * * *
*   IMPORTANT!           IMPORTANT!           IMPORTANT!   *
* * * * *
* If power is interrupted during the downline load, the   *
* firmware image can be corrupted. Do not turn off power  *
* to the unit or perform any action that can cause the   *
* unit to lose power during a downline upgrade.          *
* * * * *

=====:

... Press Return Key to Continue ...
```

Configuring the Module (Cont.)

[10] Downline Upgrade (Cont.)

When you press , the screen prompts you to Enter the Load Filename. Do the following:

- If the file is located in the default TFTP directory, enter only the filename.
- If the file is **not** located in the default TFTP directory, enter the complete pathname along with the filename.

The following example shows the dialog associated with this option using a file that is located in the default directory (user response is shown in **boldface type**):

```
Enter the Load Filename [] dettm110.bin 
```

After you enter the firmware image load filename and press , the screen prompts you to enter the IP address of the TFTP server (load host):

```
Enter the Load Host IP Address [] :16.20.54.156 
```

After you enter the load host IP address, the following screen and dialog appear:

```
Load will be initiated over the Ethernet Port network
interface.
The device becomes nonfunctional for up to 10 minutes
during the time that the flash load is in progress.
When the load is complete the screen displays the message:
(Device Not Responding!) This is normal.
... Press Return Key to Start Load [Ctrl/C to abort]...
```

NOTE: The DECrepeater 900GM is nonfunctional only during reset and self-test (about 1 minute of Stage 4) of the DLU process. During the first three stages of the process, the module continues to function as a repeater.

When you press , the DLU process is initiated over the Ethernet port network interface.

Configuring the Module (Cont.)

[10] Downline Upgrade (Cont.)

After you initiate the DLU process, the screen displays the following message:

```
DLU process started!
```

NOTE: Because of variances in network configurations (load path and traffic levels), this initial stage of the DLU process can take up to 10 minutes to complete.

CAUTION  If power is interrupted during Stage 3 of the DLU process, the firmware image can become corrupted. Do not turn off power to the unit or perform any action that can cause the unit to lose power during Stage 3 of the DLU process.

If your module is installed into a DEChub ONE, go to the section titled DLU Process Completion.

If your module is installed into a DEChub 900, the screen displays the following message:

```
Module not responding! Connection closed!
```

This is normal.

The Hub Manager status display indicates the following:

Hub Manager Status Display

```
4: DECrepeater 900GM  
unknown
```

The Hub Manager status display continues to display this message until the DLU process is complete. This is normal.

Configuring the Module (Cont.)

[10] Downline Upgrade (Cont.)

DLU Process Completion

When the DLU process is complete, the module resets and initiates self-test. After self-test completes successfully, the module exits from the DLU process and begins the execution of the new firmware image. The Module OK  LED turns on and the module becomes fully operational.

The screen displays one of the following:

- If the module is installed into a DEChub ONE docking station, the screen displays the DECrepeater 900GM INSTALLATION MENU.
- If the module is installed into a DEChub 900, the screen displays the following message:

```
Press Return for Main Menu ...
```

When you press , the screen displays the DECrepeater 900GM INSTALLATION MENU.

Configuring the Module (Cont.)

[10] Downline Upgrade (Cont.)

The following illustration shows an (expanded) example of the setup screen displays:

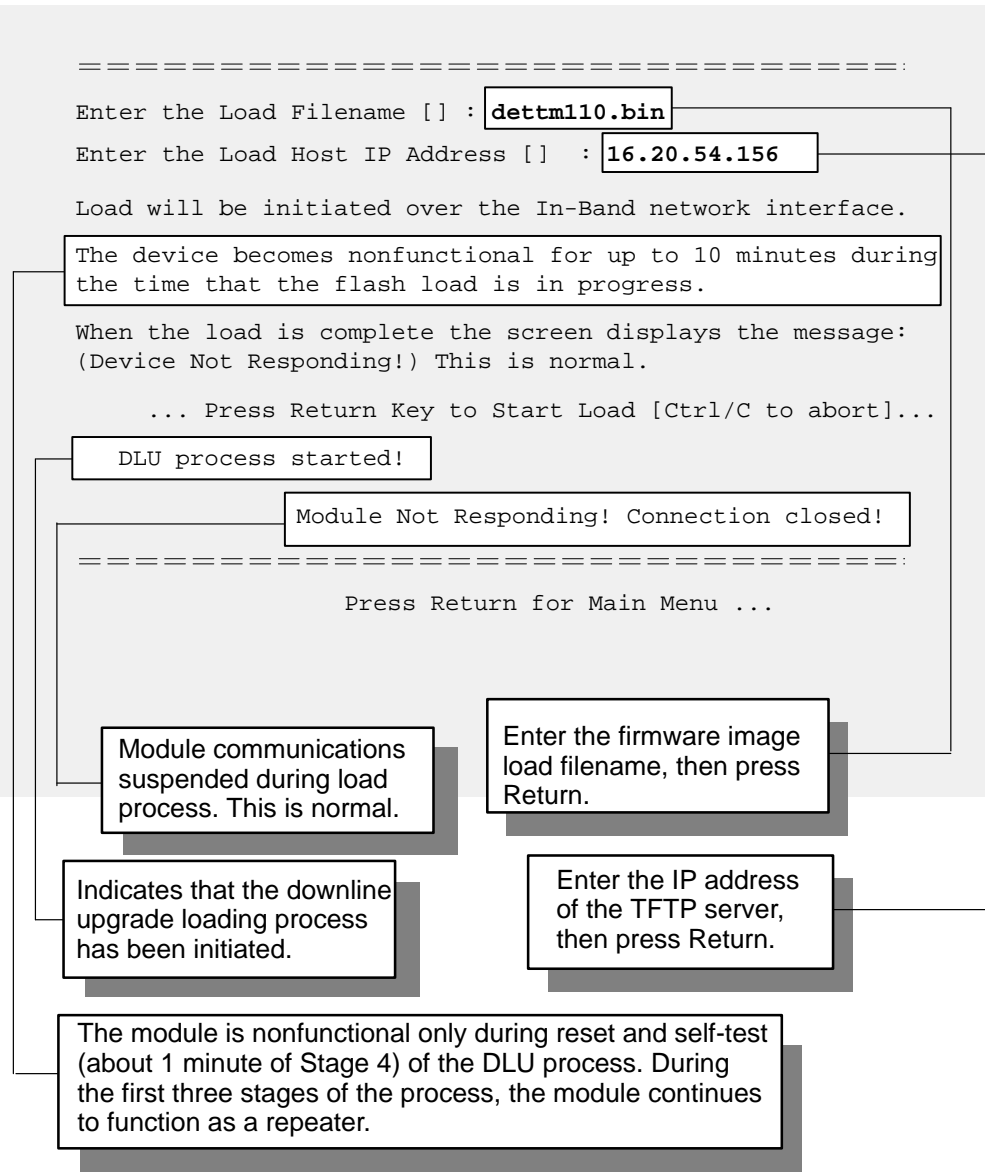

Configuring the Module (Cont.)

[11] Set Out-of-Band Management (OBM) Interface IP Address

NOTE: This selection is operational only when the module is in standalone mode (for example, when it is installed into a DEChub ONE docking station).

This option prompts you to enter the IP address of your out-of-band management interface.

This option allows you to manage your module through the OBM port located on the DEChub ONE docking station. You can enable out-of-band management in addition to normal in-band management. To enable out-of-band management, you need to assign an OBM IP address (use this option [11]) and select an OBM port speed (use option [12]) from the DECrepeater 900GM INSTALLATION MENU. See *DEChub ONE Installation* for OBM cabling information.

The following is an example of the dialog associated with this option (user response is shown in **boldface type**):

```
Enter selection : 11
DECrepeater 900GM
=====
SET OUT-of-BAND MANAGEMENT (OBM) INTERFACE IP ADDRESS
Format: The standard 4 octet dotted decimal notation in which
       each octet of the address is represented as a decimal
       value, separated by a '.' character.

       example: 16.20.40.156

To delete the IP address, enter 0 in the appropriate
address field.

=====
IP address [none] : 16.20.54.156 Return
```

Press Return for Main Menu ...

Enter the module's OBM IP address, then press Return.

Configuring the Module (Cont.)

[12] Set Out-of-Band Management (OBM) Port Speed

NOTE: This selection is operational only when the module is installed into a DEChub ONE docking station.

This option prompts you to select and enter the speed of your out-of-band management (OBM) port.

NOTE: The port speed at each end of the communications link must be identical.

The following is an example of the dialog associated with this option (user response is shown in **boldface type**):

```
Enter selection : 12
DECrepeater 900GM
=====
          SET OUT-OF-BAND (OBM) PORT SPEED
          [1] 1200 baud
          [2] 2400 baud
          [3] 4800 baud
          [4] 9600 baud
          [5] 19200 baud
          [6] 38400 baud
=====
Enter selection [2] (9600) : 2 
OBM port speed set.
Press Return for Main Menu ...
```





The OBM port speed you select must match the speed of your OBM port device.

LED Descriptions

The module LEDs provide dynamic indications of module status.

Table 2 shows the static states that are possible for each of the module LEDs.

Table 2 Module LED States

LED Name	Icon	Off	On	Flashing
Power		No power to the module.	Module receiving power.	Faulty power connection or insufficient power.
Module OK		After 1 minute, self test failed.	Module passed self-test.	Fan failure.
Network OK		Module is not connected to a properly terminated and operational LAN through the Thinwire 10Base2 port on the DEChub 900 or through the AUI port on the DEChub ONE.	Module is connected to a properly terminated and operational LAN through the Thinwire 10Base2 port on the DEChub 900 or through the AUI port on the DEChub ONE.	Network connection is disabled by network management.
Network Activity		No network activity.	Network has heavy traffic.	Flashes more rapidly and appears brighter as network traffic increases.
Port State	1 through 12	Associated port is not properly connected to another operational network device.	Associated port is properly connected to another operational network device.	Flashing once per second indicates that the associated port is disabled by network management.

(continued on next page)

LED Descriptions (Cont.)

Table 2 (Cont.) Module LED States



LED Name	Icon	Off	On	Flashing
Bank Indicator	A and B	Associated bank is not currently displaying its port connection status on the 12 Port State LEDs.	Associated bank is currently displaying its port connection status on the 12 Port State LEDs.	N/A.
AUI Power	I/O	AUI port does not have power to supply to an external MAU.	AUI port has power to supply to an external MAU.	N/A.
AUI Status	Not labeled	AUI port is not properly connected to another operational network device.	AUI port is properly connected to another operational network device.	Flashing once per second indicates that the associated port is disabled by network management.

Problem Solving Using the LEDs

When diagnosing a problem with the module, note that the problem is often indicated by the combined states of the module LEDs. Table 3 lists the states of the LEDs for various error conditions that can occur during initial installation of the device, along with probable causes and corrective actions to take.

Normal Powerup

When power to the module is initially turned on, the following events occur:

1. The Power  LED lights and remains lit. All other LEDs light and then turn off. This verifies that the individual LEDs are operational.
2. The module initiates its built-in self-test.
3. After the successful completion of self-test (within 1 minute), the Module OK  LED lights and remains lit.
4. The remaining LEDs indicate their operational status.

Problem Solving

Table 3 provides a list of symptoms indicated by the LED states along with suggestions for corrective action.

Table 3 Problem Solving Using the LEDs

Symptom	Icon	Probable Cause	Corrective Action
All LEDs are off.		The module does not have power.	<p>If installing the module into a DEChub 900, check the power status on the Hub Manager status display.</p> <p>If enough power is available, lift the release lever, and reseat the module.</p> <p>If installing the module into a DEChub ONE, ensure that the locking L-bracket screw is locked securely.</p> <p>Remove the module and inspect the module's 48-pin and 160-pin connectors for bent, broken, or dirty pins.</p> <p>If any pins are broken or bent, replace the module.</p>

(continued on next page)

Problem Solving Using the LEDs (Cont.)

Table 3 (Cont.) Problem Solving Using the LEDs

Symptom	Icon	Probable Cause	Corrective Action
All LEDs are off.		The module does not have power.	If no pins are broken or bent, reinstall the module. If the problem persists, replace the module.
Power LED is off.	⏻	Faulty power LED.	Replace the module.
Power LED is flashing.	⏻	Faulty power LED. Faulty DEChub 900 slot connection. DEChub 900 or DEChub ONE power supply is faulty.	Replace the module. Reinstall the module into another slot. Replace the DEChub 900 power supply or the DEChub ONE.
Module OK LED is off.	⌚	Module does not have sufficient power. Self-test is in progress. Self-test failed.	Ensure Power LED is on. Wait up to 1 minute for self-test to complete. If the LED does not light after 1 minute, reseal the module to repeat the self-test. If self-test fails again, replace the module.
Module OK LED is flashing.	⌚	Fan is faulty.	Contact your Digital service representative to replace the fan.

(continued on next page)

Problem Solving Using the LEDs (Cont.)

Table 3 (Cont.) Problem Solving Using the LEDs

Symptom	Icon	Probable Cause	Corrective Action
Port State LED is off.		Associated port is not properly connected to another operational network device.	Properly connect the associated port to network or station. Reseat the cable. If problem persists, replace the cable.
Port State LED is flashing about once per second.		Associated port is disabled by network management.	Enable the associated port, if necessary.

Connector Pin Assignments

To install the DECrepeater 900 GM, use either a 50-pin Telco to 50-pin Telco cable or the 50-pin Telco to 12-pin MJ cable (P/N BN26U-03).

Telco Connector

The following illustration shows a 50-pin Telco connector and its pin assignments:

Pin	Assignment	Ports	Pin	Assignment	Ports
1	RX-	A12, B12	26	RX+	A12, B12
2	TX-	A12, B12	27	TX+	A12, B12
3	RX-	A11, B11	28	RX+	A11, B11
4	TX-	A11, B11	29	TX+	A11, B11
5	RX-	A10, B10	30	RX+	A10, B10
6	TX-	A10, B10	31	TX+	A10, B10
7	RX-	A9, B9	32	RX+	A9, B9
8	TX-	A9, B9	33	TX+	A9, B9
9	RX-	A8, B8	34	RX+	A8, B8
10	TX-	A8, B8	35	TX+	A8, B8
11	RX-	A7, B7	36	RX+	A7, B7
12	TX-	A7, B7	37	TX+	A7, B7
13	RX-	A6, B6	38	RX+	A6, B6
14	TX-	A6, B6	39	TX+	A6, B6
15	RX-	A5, B5	40	RX+	A5, B5
16	TX-	A5, B5	41	TX+	A5, B5
17	RX-	A4, B4	42	RX+	A4, B4
18	TX-	A4, B4	43	TX+	A4, B4
19	RX-	A3, B3	44	RX+	A3, B3
20	TX-	A3, B3	45	TX+	A3, B3
21	RX-	A2, B2	46	RX+	A2, B2
22	TX-	A2, B2	47	TX+	A2, B2
23	RX-	A1, B1	48	RX+	A1, B1
24	TX-	A1, B1	49	TX+	A1, B1
25	NC		50	NC	

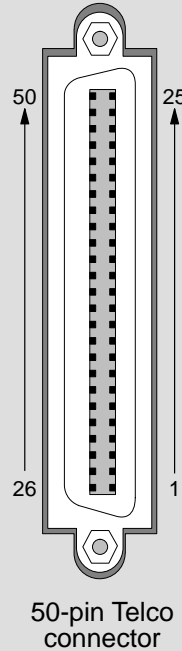

LKG-8764-931

Connector Pin Assignments (Cont.)

BN26U-03 Cable

The following illustration shows a BN26U-03 cable and its pin assignments:

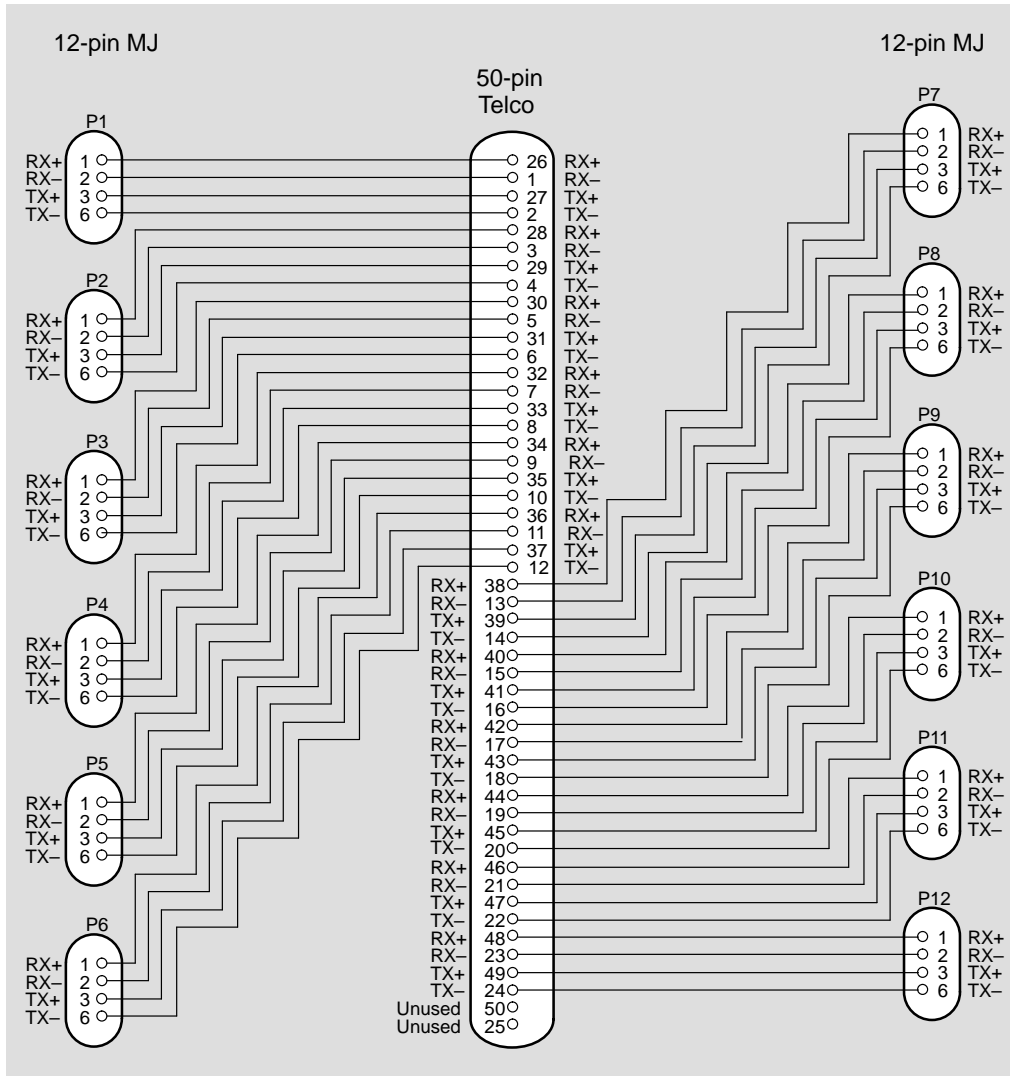

LKG-8928-94I

Connector Pin Assignments (Cont.)

H8571-J Adapter

The following illustration shows the H8571-J adapter (6-pin MMJ to 9-pin D-Sub connector) and its pin assignments:

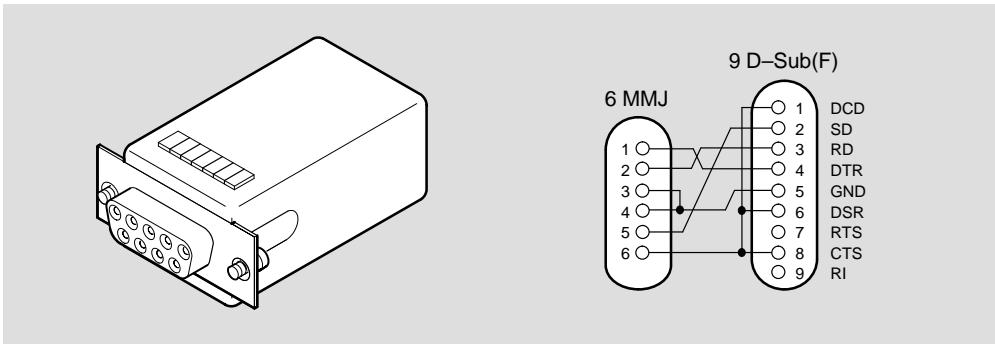

LKG-5342-911

H8575-A Adapter

The following illustration shows the H8575-A adapter (6-pin MMJ connector to 25-pin D-Sub connector) and its pin assignments:

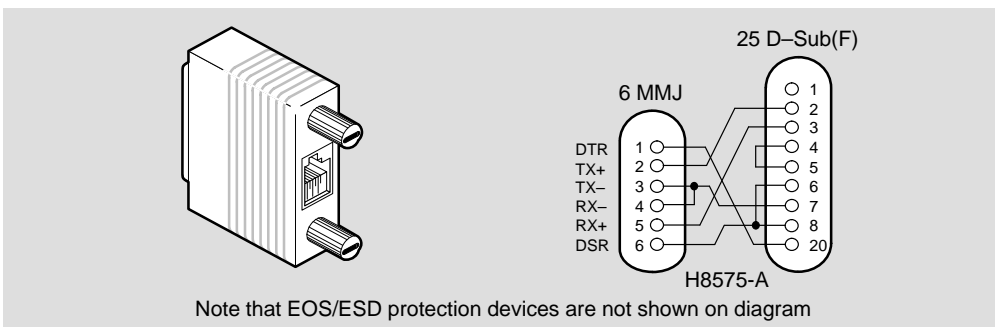

LKG-8793-931

Connector Pin Assignments (Cont.)

AUI (15-pin D-Sub) Port Connector

The following illustration shows a 15-pin AUI connector and its pin assignments:

<u>Pin</u>	<u>Ports</u>	<u>Pin</u>	<u>Ports</u>	<u>Pin</u>	<u>Ports</u>
1	Ground	6	Power rtn	11	Ground
2	CI+	7	NC	12	DI-
3	DO+	8	Ground	13	Power (12V)
4	Ground	9	CI-	14	Ground
5	DI+	10	DO-	15	NC

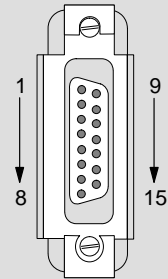

15-pin AUI
connector

LKG-8866-931

Product Specifications

Table 4 lists the DECrepeater 900GM operating specifications.

Table 4 DECrepeater 900GM Operating Specifications

Parameter	Specification
<i>Operating Environment</i>	
Operating Temperature ¹	5°C to 50°C (41°F to 122°F)
Relative Humidity	10% to 95% noncondensing
Altitude	Sea level to 4900 m (16,000 ft)
Power	35.0 W, total power 4.0 A, 5Vdc, 0.1 A, 12Vdc ² 1.0 A, 15Vdc
<i>Connectors</i>	
Two Telco, one AUI	
(DEChub ONE has one 8-pin MJ, one DB-9, and one 15-pin D-Sub AUI connector.)	
<i>Physical</i>	
Height	44.45 cm (17.5 in)
Width	4.45 cm (1.75 in)
Depth	15.25 cm (6 in); 25.40 cm (10.0 in) with a DEChub ONE docking station.
Weight	1.8 kg (4 lb); 3.4 kg (7.5 lb) with a DEChub ONE docking station.
<i>Certification</i>	
CE, CSA, FCC, TÜV, UL, VCCI	

¹ For sites above 4900 m (16,000 ft), decrease the operating temperature specification by 1.8°C for each 1000 m or 3.2°F for each 3200 ft.

² The 12V power in the DEChub 900 is derived from the 15V power source. Although it is listed separately in the product specifications, the 12V requirements are included in the 15V power total.

Product Specifications (Cont.)

Table 5 lists the DECrepeater 900GM acoustical specifications.

Table 5 Acoustical Specifications

Acoustics — Declared values per ISO 9296 and ISO 7779¹

Product	Sound Power Level L_{WA}d, B	Sound Pressure Level L_pAm, dBA (bystander positions)
	<i>Idle/Operate</i>	<i>Idle/Operate</i>
DETTM	4.9	35
DETTM + DEHUA	5.3	39

Schallemissionswerte — Werteangaben nach ISO 9296 und ISO 7779/DIN EN27779²

Produkt	Schalleistungspegel L_{WA}d, B	Schalldruckpegel L_pAm, dBA (Zuschauerpositionen)
	<i>Leerlauf/Betrieb</i>	<i>Leerlauf/Betrieb</i>
DETTM	4,9	35
DETTM + DEHUA	5,3	39

¹ Current values for specific configurations are available from Digital Equipment Corporation representatives. 1 B = 10 dBA.

² Aktuelle Werte für spezielle Ausrüstungsstufen sind über die Digital Equipment Vertretungen erhältlich. 1 B = 10 dBA.

Associated Documents

The following documents provide related information about the module. Ordering information is provided at the back of this manual.

Title and Order Number	Description
<i>DEChub 900 MultiSwitch Owner's Manual</i> EK-DH2MS-OM	Provides installation, use, security, and troubleshooting information.
<i>HUBwatch Installation and Configuration</i> AA-Q0FXB-TE	Provides information for installing and configuring HUBwatch for Windows V2.0.
<i>HUBwatch Use</i> AA-PW4BC-TE	Provides network management and DEChub 900, DEChub 90 and DEChub ONE functionality information for HUBwatch for Open VMS V3.0.
<i>DEChub 90 Owner's Manual</i> EK-DEHUB-OM	Provides installation, use, security, and troubleshooting information.
<i>Using DECndu Plus (MS-DOS)</i> AA-PYVVA-TE	Provides instructions to upgrade the firmware in an MS-DOS environment in selected network devices using Digital's Network Device Upgrade (DECndu) Plus utility.
<i>Using DECndu Plus (ULTRIX RISC)</i> AA-PYVTA-TE	Provides instructions to upgrade the firmware in an ULTRIX RISC environment in selected network devices using Digital's Network Device Upgrade (DECndu) Plus utility.
<i>Using DECndu Plus (OPENVMS VAX)</i> AA-PYVRA-TE	Provides instructions to upgrade the firmware in an OPEN VMS VAX environment in selected network devices using Digital's Network Device Upgrade (DECndu) Plus utility.
<i>OPEN DECconnect Applications Guide</i> EC-G2570-42	Contains general descriptions to help plan and install networking systems based on Digital Equipment Corporation's OPEN DECconnect system and networking products.

HOW TO ORDER ADDITIONAL DOCUMENTATION

DIRECT TELEPHONE ORDERS

In Continental USA
call 1-800-DIGITAL
(1-800-344-4825)

In Canada
call 1-800-267-6215

In New Hampshire,
Alaska or Hawaii
call 1-603-884-6660

ELECTRONIC ORDERS (U.S. ONLY)

Dial 1-800-dec-demo with any VT100 or VT200
compatible terminal and a 1200 baud modem.

If you need assistance, call 1-800-DIGITAL (1-800-344-4825)

DIRECT MAIL ORDERS (U.S. and Puerto Rico*)

DIGITAL EQUIPMENT CORPORATION
P.O. Box CS2008
Nashua, New Hampshire 03061

DIRECT MAIL ORDERS (Canada)

DIGITAL EQUIPMENT OF CANADA LTD.
940 Belfast Road
Ottawa, Ontario, Canada K1G 4C2
Attn: A&SG Business Manager

INTERNATIONAL

DIGITAL EQUIPMENT CORPORATION
A&SG Business Manager
c/o Digital's local subsidiary
or approved distributor

Internal orders should be placed through U.S. Software Supply Business (SSB),
Digital Equipment Corporation, 10 Cotton Rd. Nashua, NH. 03063-1260

*Any prepaid order from Puerto Rico must be placed
with the Local Digital Subsidiary:
809-754-7575

**DECrepeater 900GM Installation and Configuration
EK-DETTM-IN. B01**

Please return this card.

Your comments and suggestions will help us improve the quality and usefulness of our documentation.

Did you use the manual as a reference or as a step-by-step procedure to install the device?

Were the instructions easy to follow? _____

Were the instructions complete? _____

Were they in the proper sequence? _____

Which chapters or sections were most helpful? _____

Did you use the appendixes? Which ones? _____

Were the illustrations helpful? _____ All? _____ Some? _____ Which ones? _____

Were some illustrations unnecessary? _____ Which ones? _____

Do you think the manual needs more illustrations? _____ Please give an example. _____

Thank you.

Name _____ Date _____

Title _____ Department _____

Organization _____ Street _____

City _____ State/Country _____ Zip Code _____

DO NOT CUT – FOLD HERE AND TAPE

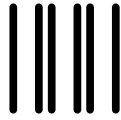

NO POSTAGE
NECESSARY
IF MAILED
IN THE
UNITED STATES

BUSINESS REPLY LABEL
FIRST CLASS PERMIT NO. 33 MAYNARD MASS.

POSTAGE WILL BE PAID BY ADDRESSEE



Information Design and Consulting
550 King Street, LKG1-3/L12
Littleton, MA 01460-1289

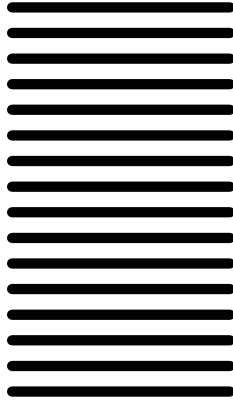

DO NOT CUT – FOLD HERE