

DIGITAL HiNote
Ultra 2000 Series

Service Quick Reference Guide

Part Number: ER-PF1WW-SR. B01

February 1998

The information in this document is subject to change without notice and should not be construed as a commitment by Digital Equipment Corporation.

Digital Equipment Corporation assumes no responsibility for any errors that might appear in this document.

The software described in this document is furnished under a license and may be used or copied only in accordance with the terms of such license. No responsibility is assumed for the use or reliability of software or equipment that is not supplied by Digital Equipment Corporation or its affiliated companies.

Restricted Rights: Use, duplication, or disclosure by the U.S. Government is subject to restrictions as set forth in subparagraph (c) (1) (ii) of the Rights in Technical Data and Computer Software clause at DFARS 252.227-7013.

*DIGITAL HiNote Ultra 2000 Series Service
Quick Reference Guide*

Copyright © Digital Equipment Corporation.
All Rights Reserved.

DEC, DIGITAL, ThinWire, and the DIGITAL logo are registered trademarks of Digital Equipment Corporation
ESS is a registered trademark of ESS Corp.
Intel and Pentium are registered trademarks of Intel Corporation
Microsoft, MS-DOS, and Windows are registered trademarks of Microsoft Corporation.

All other trademarks and registered trademarks are the property of their respective holders.

FCC Notice

This equipment has been tested and found to comply with the limits for a Class B digital device, pursuant to Part 15 of the FCC rules. These limits are designed to provide reasonable protection against harmful interference in a residential installation.

Any changes or modifications made to this equipment may void the user's authority to operate this equipment.

This equipment generates, uses, and can radiate radio frequency energy and, if not installed and used in accordance with the instructions, may cause harmful interference to radio communications. However, there is no guarantee that interference will not occur in a particular installation. If this equipment does cause harmful interference to radio or television reception, which can be determined by turning the equipment off and on, the user is encouraged to try to correct the interference by one or more of the following measures:

- Reorient or relocate the receiving antenna
- Increase the separation between the equipment and receiver
- Connect the equipment into an outlet on a circuit different from that to which the receiver is connected
- Consult the dealer or an experienced radio/TV technician for help

All external cables connecting to this basic unit need to be shielded. For cables connecting to PCMCIA cards, see the option manual or installation instructions.

Contents

Preface	v
1	
Overview	
Introduction.....	1-1
System Overview	1-1
CPU and Chip Set.....	1-2
Memory.....	1-3
BIOS.....	1-3
PCI Bus Devices	1-4
ISA Bus Devices.....	1-6
Docking Options.....	1-8
Components, Controls and Indicators	1-10
Related Information	1-22
2	
System Restoration	
Introduction.....	2-1
VTX5166M/GTX5166M System Restoration.....	2-2
Windows 95 System Restoration	2-2
Windows NT 4.0 System Restoration	2-10
GTX5233M/GTX5266M System Restoration	2-13
Windows 95 System Restoration	2-13
Windows NT System Restoration	2-25
3	
System BIOS	
Introduction.....	3-1
BIOS Setup Program.....	3-1
System Setup Utility	3-2

Contents

Updating Your Ultra 2000 Configuration	3-3
Power Options.....	3-4
Advanced Power Options.....	3-6
System Options	3-7
Device Options	3-8
Security Options	3-10
Notebook Computer Security	3-12
User Password	3-13
Supervisor Password	3-14
Dock Security	3-16
Default Options.....	3-17
Exit Options	3-17
Restoring the Flash BIOS.....	3-18
4	
Troubleshooting	
Introduction.....	4-1
Troubleshooting Tips.....	4-2
External Audio Failure	4-15
Check Points and Error Messages.....	4-15
Beep Codes.....	4-16
Phoenix BIOS Test Points.....	4-17
Warning Messages.....	4-23
5	
FRU Replacement	
Introduction.....	5-1
Required Tools	5-2
Field Replaceable Units	5-3
Removing the Battery.....	5-7
Removing the CD/FDD Module.....	5-8
Removing the Keyboard.....	5-9
Removing the HDD Assembly.....	5-11
Removing the Keyboard Deck and LCD Assembly.....	5-14
Shell Installation Instructions.....	5-20
A	
Specifications	
VTX5166M & GTX5166M Specifications	A-1
GTX5233M & GTX5266M Specifications	A-3
Environmental Specifications	A-5

Contents

B

Device Mapping

Memory Map.....	B-1
DMA Channel Assignments	B-2
Notebook Computer Interrupt Levels	B-3
I/O Address Map	B-4

Contents

Preface *P*

This Service Quick Reference Guide describes how to test, troubleshoot, remove and replace the DIGITAL HiNote Ultra 2000 series notebook computer Field Replaceable Units (FRUs).

This guide is written specifically for DIGITAL approved on-site service engineers. On-site repair of systems beyond the approved FRU list is prohibited and may void warranty.



CAUTION: Digital recommends that only A+ certified engineers attempt to repair this equipment. All troubleshooting and repair procedures are detailed to support subassembly/module level exchange. Because of the complexity of the individual boards and subassemblies, no one should attempt to make repairs at the component level or make modifications to any printed circuit board. Improper repairs can create a safety hazard. Any indications of component replacement or circuit board modifications might void any warranty or exchange allowances.

Preface

Overview *1*

Introduction

This chapter introduces the DIGITAL HiNote Ultra 2000 series notebook computers. It provides a system overview and describes the controls, indicators, and hot keys.

System Overview

The HiNote Ultra 2000 series are high-performance portable computers designed for the mobile professional.

Figure 1-1 shows a functional block diagram of the notebook computer. The following sections provide an overview of the different functions.

Overview

CPU and Chip Set

The HiNote Ultra 2000 series notebook computers use the Intel P54M CPU DAUGHTER CARD.

The PicoPower Vesuvius chip set is used to implement the core functions of the system.

- The V1 and V2 chips provide the core system functions.
- The V2 chip provides the PCI bus interface and the interface between the V1 chip and memory.
- The V3 chip provides the PCI to ISA bridge interface.

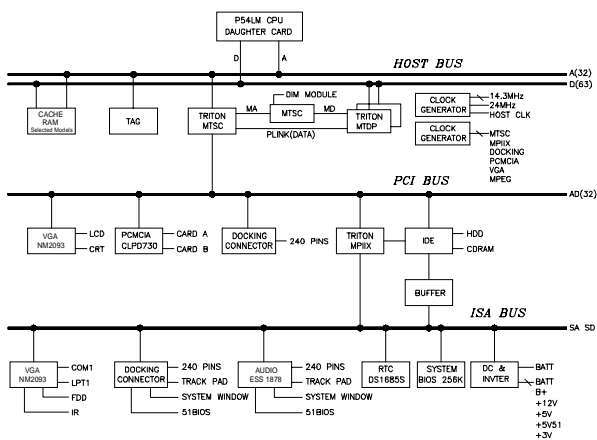

Figure 1-1. Functional Block Diagram

Overview

Memory

The system comes with 16 MB of on-board EDO DRAM for system memory and 512KB or 1MB of L2 cache memory.

System memory can be upgraded to a total of 144 MB. The upgrade is performed by installing 8 MB, 16 MB, 32 MB or 64 MB EDO SO-DIMM modules. There are two slots for additional memory. Either slot can be populated first.

BIOS

The system has an Intel 28F002BX-T 2 MB Boot block Flash ROM for system BIOS (Phoenix BIOS 4.04). The BIOS provides support for the following:

- Suspend to RAM
- Full APM 1.2 supported
- Password protection(System and Docking options)
- Auto-configured with docking options
- Windows 95 ready with PnP
- Various hot-keys for system control

Overview

PCI Bus Devices

The internal PCI bus and PCI components operate at 3.3V. The PCI bus is also available to supported docking options. These options contain their own PCI bridge.

Cardbus Controller

Cardbus support is provided by the TI1131 controller. This chip provides the following functions:

- Support for Zoomed Video.
- Support for two PC Card/Cardbus slots with hot removal/insertion.
- Burst transfers to maximize data throughput on the PCI/Cardbus bus.
- Support for serialized ISA IRQs.
- Support for 16-bit distributed DMA.
- Support for Ring Indicate.

Overview

Video Controller Chip

Video support is provided by the C&T 65554 Controller Chip. This chip provides the following functions:

- 64-bit memory interface.
- 2MB or 4MB 3.3V 60ns EDO Video DRAM.
- Support for Zoomed Video.
- DDC 2B support for external monitors.
- Advanced power management features minimize power consumption during:
 - Normal operation
 - Standby mode
 - Panel-off

PCI-IDE Controller

IDE support is provided by the CMD 643 PCI-IDE controller. This chip provides the following functions:

- PCI bus Master device.
- Supports up to mode 5 timing.
- Supports DMA capable drives.
- Supports two IDE controllers (only one used).

Overview

ISA Bus Devices

The ISA bus interface is provided by the PicoPower V3 chip.

Audio

Audio support is provided by the ES1878 chip. This chip provides the following functions:

- Monophonic full-duplex operation using two DMA channels.
- I²S interface to internal stereo D/A for external Zoomed Video port.
- Complete general interrupt mapping including the sharing of all interrupts.
- Support for 16-bit Stereo, FM Synthesizer, MPU-401, and MIDI.
- Self-timed joystick port.
- Hot docking 6-pin interface to expansion audio mixer (ES978).

BIOS

The system BIOS is implemented using the Intel 28F002BX-T 2 MB Boot block Flash ROM.

Overview

System Command Processor

The System Command Processor is implemented using the Hitachi H8 IKAP II processor. This processor provides the following functions:

- Simultaneous support of two external PS/2 ports and the internal Touch pad.
- I²C bus master for communication to:
 - Status LCD
 - EEPROM
 - Docking interface components
- Hot Key interface.
- Secure password protection.
- System power plane control and power sequencing.
- Battery management interface for charging and the Smart battery information.
- Status LCD and device monitoring interface.
- Active thermal interface for CPU thermal management.
- Internal keyboard scanning.

Super I/O

I/O support is provided by the National Semiconductor PC87338 chip. This chip supports the following functions:

- Floppy disk controller with Japanese floppy support.
- IEEE 1284 Parallel port.
- Serial infrared support – IrDa 1.1 (115Kbps and 4Mbps).
- 16550 UARTs.
- Full Plug-and-Play support.

Overview

UMI Controller

The DIGITAL HiNote Ultra 2000 notebook computer has an internal type II PCMCIA slot that is available as an UMI slot. This feature provides a flexible method for the support of an internal modem that minimizes the impact of multi-national modem approvals. This slot supports only DIGITAL approved modem cards. The UMI interface is provided by the Cirrus Logic CL-PD6722 dual slot PCMCIA controller (Only one slot is used.) This chip provides the following features and functions:

- PCMCIA 2.1 and JEIDA 4.1 compliant.
- Automatic low power mode (improved power consumption).
- Direct connection to the ISA bus and PCMCIA socket.
- Five programmable memory windows and two I/O windows.
- DMA support.

Docking Options

The DIGITAL HiNote Ultra 2000 notebook computer supports docking options. Active docking options are required to have a NILE PCI-PCI bridge.

DIGITAL HiNote Ultra Multimedia Dock

The DIGITAL HiNote Ultra Multimedia Dock has the following features:

- Three speakers: two tweeters and one sub-woofer.
- Super I/O duplication for port replication the DIGITAL HiNote Ultra Enhanced Port Replicator.
- Nile I PCI-PCI bridge.
- PicoPower V3 PCI-ISA bridge.

Overview

- Two Type II or one Type III Cardbus slot.
- Line-in and speaker out support.
- MIDI/Joystick port.
- 3D Sound (ESS398).
- CD-ROM/FDD Module Bay.
- NTSC/PAL video output (switch selectable).
 - Composite video using RCA jack
 - S-Video
- USB controller and USB port.
- Expansion audio mixer support (ES978).

DIGITAL HiNote Ultra Enhanced Port Replicator

The DIGITAL HiNote Ultra Enhanced Port Replicator has the following features:



- Battery charger
- Parallel port
- Serial port
- VGA/CRT port
- Two PS/2 connections for keyboard and mouse
- USB port (pass-through from DIGITAL HiNote Ultra Multimedia Dock)

Overview

Components, Controls and Indicators

This section shows the locations and provides a description of the different components, controls, and indicators on your DIGITAL notebook computer.

Front and Right Side Components

Key	Component	Description
❶	Power LED Battery Charging LED	The green Power LED (lower) lights when the notebook is On. The amber Battery Charging LED (upper) lights when the battery is charging.
❷	Lid Release	One of two lid releases. Push in both releases at the same time to open the LCD panel.
❸	Speaker	Right stereo speaker used to hear sound files and system sounds.
❹	CD-ROM/Diskette Drive Bay	Supports a CD-ROM drive or a Diskette Drive module.
❺	Microphone In 	Input connection for external microphone.
❻	Audio Out 	Connection for headphones or external speakers.

continued

Overview

Key	Component	Description
7	Suspend/Resume Button	Turns the notebook computer On, and Suspends or Resumes the system. Press and hold the [fn] + [Suspend/Resume] for four seconds to turn the notebook Off.
8	Internal Microphone	Used to record voice, music, and sound files.
9	Status Display	Provides system operating status.
10	Contrast Control (ASTN only)	Controls the contrast of the LCD display.
11	Reset button	Resets the notebook computer. All unsaved data will be lost. Refer to Figure 6-3 for instructions on how to lift the keyboard to gain access to the reset button.

Overview

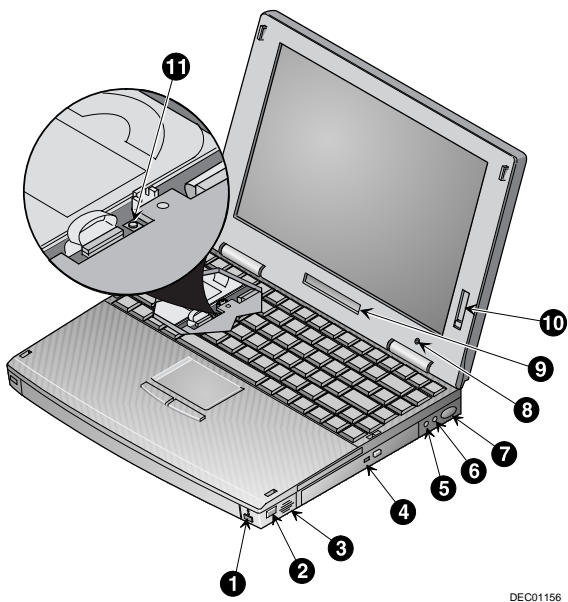

DEC01156

Figure 1-2. Front and Right Side View (12.1" Display)

Overview

Front and Left Side Components

Key	Component	Description
❶	Lid Release	One of two lid releases. Push in both releases at the same time to open the LCD panel.
❷	Speaker	Left stereo speaker used to hear sound files and system sounds.
❸	PC Card Ejectors	Ejects a PC Card. Top button releases a PC Card from the top slot; the bottom button releases a PC Card from the bottom slot.
❹	PC Card Slots	Support two Type I or II cards or one Type III card. Zoomed Video cards are supported in the lower slot only.
❺	Keyboard Releases	These latches release the keyboard to allow access to the removable hard drive and the system Reset button.
❻	Removable Hard Drive	Located under the keyboard, the hard drive is easily removable and upgradeable.
❼	Security Lock	Attach a security locking device, such as a Kensington lock, to this port.



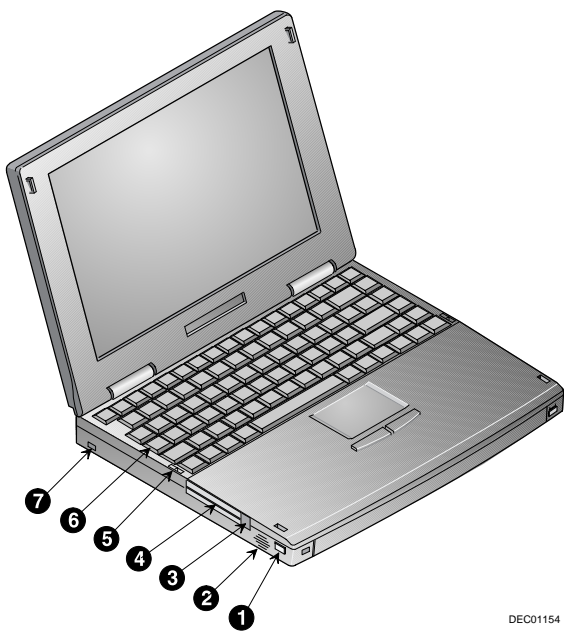

Overview



DEC01154

Figure 1-3. Front and Left Side View (12.1" TFT Display)

Back Components

Key	Component	Description
①	AC In 	The universal AC adapter connects to this port.
②	External Keyboard/ Mouse Port 	An external keyboard or PS/2 mouse connects to this port.
③	RJ11 Modem Port	An analog telephone line connects to this port (modem functionality on selected models only).
④	Serial Port 	A serial device connects to this port.
⑤	Parallel Port 	A parallel device, such as a printer, connects to this port.
⑥	Video Port 	An external monitor connects to this port.
⑦	I/O Connector Cover and Keyboard Support	Covers I/O connectors. Can be flipped down to support the keyboard at a comfortable typing angle.
⑧	Fast IR Port	Fast IR interface allows wireless data transfer between the notebook and another device with an IR interface.

Overview

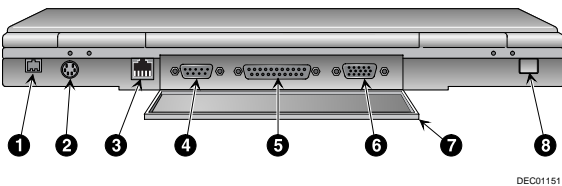
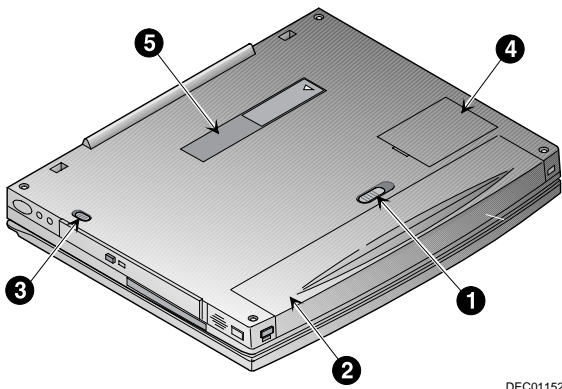

Figure 1-4. Back View

Bottom Components

Key	Component	Description
❶	Battery Release	Releases the Lilon battery from the notebook computer for removal.
❷	Lilon Battery	Provides power to your notebook computer.
❸	CD-ROM/Diskette Drive Module Release	Releases either a diskette or CD-ROM Drive module from the Diskette/CD-ROM Drive Bay.
❹	Memory Door	Provides access to notebook computer's memory.
❺	Docking Connector Door	Provides access to the docking connector when using the DIGITAL HiNote Ultra Multimedia Dock or the DIGITAL HiNote Ultra Enhanced Port Replicator.

Overview







DEC01152

Figure 1-5. Bottom View

Overview

Controlling Power

Unique to DIGITAL notebook's, the suspend/resume button not only enables you to take advantage of the built-in power saving features but also turns the notebook on and off.











Action	How to...
On 	Press the Suspend/Resume button to turn the system on.
Suspend 	When the system is on, press this button to place your system in Suspend mode.
Resume 	Press the Suspend/Resume button to resume normal operation from the Suspend mode.
Off  + 	To completely shut off your notebook, press and hold [fn + suspend/resume] button until a system beep sounds, indicating that the system has been successfully turned off.
Suspend Lid Switch	In its factory default mode, closing the LCD lid will also enter the notebook into Suspend mode. Refer to Chapter 3, in the section labeled <i>Power Menu</i> for instructions on how to configure the Lid Switch function.



CAUTION

If you turn the notebook computer off without saving and closing all open files, you may lose some or all of your work.







LCD Status Display

Indicator	Shows...
	AC Power – The computer is connected to and operating from its external AC power supply.
	Standby – The computer is in Standby Mode. Any system activity such as, pressing a key on the keyboard, touch pad, mouse, or other system activity resumes normal operation.
	Hard Drive/CD-ROM Activity – The hard drive or CD-ROM is being accessed.
	The Caps Lock function is enabled..
	NUM Lock – The NUM Lock function is enabled.
	Monitor/Scroll Lock – The external monitor port is enabled and/or the Scroll Lock function is enabled.
	– External Monitor port enabled
	– Scroll Lock function enabled
	– External monitor and Scroll Lock enabled
	Embedded Numeric Key pad – The keyboard's embedded key pad is enabled by a keyboard hot-key.

Overview











Keyboard Hot Keys

Hot keys are activated by holding down the [fn] key (located in the lower left corner of the keyboard) and pressing the desired function key.

 +	Function
	Places the computer in Standby Mode.
	Sets the computer's operating mode to maximize battery life. A single beep is emitted when the computer switches to this operating mode. If you Suspend/Resume or Reboot the system, the system returns to the settings contained in the system BIOS.
	Sets the computer's operating mode to maximize performance. Two beeps are emitted when the computer switches to this operating mode. If you Suspend/Resume or Reboot the system, the system returns to the settings contained in the system BIOS.
	Used during Power Up Self-Test (POST) to enter the System setup program.
	Enables and disables the computers external display port and the LCD display. There are three display modes: LCD Display LCD Display and External Monitor (simulscan) External Monitor only Each time you press this hot key, the computer changes to the next display setting. The display mode for the External Monitor is shown on the LCD Status display.

continued

Overview

 +	Function
	Turns the battery display information On and Off.
	Reserved for future use.
	Toggles the system sound between mute and unmute.
	Enables and disables the keyboard's embedded key pad. The state of this key is shown in the LCD status display. This hot key is used in conjunction with the [F9] hot key to control the embedded key pad.
	Toggles NUM Lock On and Off. The state of NUM Lock is shown in the LCD Status Display. This hot key is used in conjunction with the [F8] hot key to control the embedded key pad.
	Toggles Scroll Lock On and Off. The state of Scroll Lock is shown in the LCD Status Display.
	Depress repeatedly to increase the audio volume.
	Depress repeatedly to decrease the audio volume.
	Depress repeatedly to decrease the LCD screen brightness.
	Depress repeatedly to increase the LCD screen brightness.

Overview

Related Information

Documentation

DIGITAL HiNote Ultra 2000 Series User's Guide	English	ER-PF1WW-UA	
	French	ER-PF1WW-UP	
	Italian	ER-PF1WW-UI	
	German	ER-PF1WW-UG	
	Spanish	ER-PF1WW-US	
	Japanese	ER-PF1WW-UJ	
	Simple Chinese	ER-PF1WW-U2	
DIGITAL HiNote Ultra 2000 Series Quick Reference Card	English	ER-PF1WW-BA	
	French	ER-PF1WW-BP	
	Italian	ER-PF1WW-BI	
	German	ER-PF1WW-BG	
	Spanish	ER-PF1WW-BS	
	Japanese	ER-PF1WW-BJ	
Quick Setup Guide	English, French, Italian, German, Spanish	ER-PF1WW-IM	
	English, Japanese, Simple Chinese	ER-PF1WF-I8	
	English	ER-PB1WF-DM	
AC Adapter Bulletin	English	ER-PB1WF-DM	
	DIGITAL HiNote System CD	VTX5166M/ GTX511M	AG-R4RB*-BE (Win95) AG-R7KN*-BE (WinNT)
		GTX5233M/ GTX5266M	AG-RA3T*-BH (Win95) AG-RA3V*-BH (WinNT)

Overview

World Wide Web

Information such as drivers, BIOS updates, and on-line documentation is available from DIGITAL's World Wide Web Site.

The URL for the site is:

`HTTP://WWW.WINDOWS.DIGITAL.COM/`

Overview

System Restoration **2**

Introduction

This chapter provides information on how to restore the operating system and drivers on a DIGITAL HiNote Ultra 2000 series notebook computer. The restoration procedure you should use is dependent on the system model. This chapter has been divided into the following sections:

- VTX5166M/GTX5166M System Restoration
 - Windows 95 System Restoration
 - Windows NT System Restoration
- GTX5233M/GTX5266M System Restoration
 - Windows 95 System Restoration
 - Windows NT System Restoration



CAUTION: Do not compress the boot drive using compression utilities. It will cause the notebook computer's Save to File feature to not function properly.

System Restoration

VTX5166M/GTX5166M System Restoration

Windows 95 System Restoration

This section details how to format a new or existing hard drive, install Windows 95 SR2, drivers and software applications. To complete the process you must have the Windows 95 SR2.0 OS CD and the DIGITAL HiNote Ultra 2000 System CD. This restoration procedure has been divided into the following sections and must be followed in the order given.

- Setup Utility Configuration Changes
- Formatting a Hard Drive
- Windows 95 Installation
- Installing System Drivers
 - IDE CMD Driver
 - PCMCIA Drivers
 - USR Winmodem
 - Video, Audio/Joystick, and IR/USB Drivers

Setup Utility Configuration Changes

1. Insert the CD-ROM Drive module into the notebook's expansion bay and boot the system.
2. During the Memory Self-test, press the [fn] + [F3] key combination to enter the Setup Utility.

System Restoration

3. Ensure that the Serial and Infrared Ports are both set to "Auto set by PnP" and enable the CD-ROM Boot option. Refer to the DIGITAL HiNote Ultra 2000 User's Guide for detailed instructions on configuring the Setup Utility.
4. Place the DIGITAL HiNote Ultra 2000 System CD into the CD-ROM Drive.
5. Select the Save & Reboot option from the Setup Utility Exit menu. Note the drive letter assigned to the CD-ROM during bootup. The system will boot to the DIGITAL HiNote Ultra 2000 System CD.

Formatting the Hard Drive



CAUTION: This procedure will erase all data residing on the Hard Disk Drive. Before proceeding, ensure all important files are backed up.

This procedure assumes the DIGITAL HiNote Ultra 2000 Media Dock is not attached to the notebook.

1. When the system boots to the DIGITAL HiNote Ultra System CD, the system will prompt you whether or not you want to continue booting using this CD, press [Y]. Then a second screen will appear prompting you to press any key to continue, press the Space bar. An action menu will appear.
2. Select option 2 to initialize and partition a new hard drive using the FDISK utility.

When running FDISK, you will be prompted whether or not to enable large disk (FAT32) support. Choose No to enable FAT16. Also make sure you set the Active Partition flag to make it bootable.

System Restoration



NOTE: If you choose Yes to enable large disk support (FAT32) and want to install WinNT or a WIN95 non-SR2 operating system at a later time, you will have to repeat the complete Windows 95 System Restoration procedure and enable FAT16.

3. Reboot the system. When prompted press the Space bar to continue and the action menu will appear.
4. Choose option 3 to Format the C: partition of your hard drive.
5. To Format other drive partitions that may have been created in step 2, choose option 5 to exit to the DOS prompt. Enter the following command line: `FORMAT X: /U`, where X is the drive letter assigned to the drive partition to be formatted. Repeat this step for each additional partition.
6. To re-enter the bootable System CD menu, type `MENU` and press the Enter key.
7. Choose option 4, "Prepare to install Microsoft Windows from CD onto a newly formatted hard drive" to copy all necessary CD-ROM and system startup files to the C: drive.
8. Power down the system.

Windows 95 Installation

1. Place the Windows 95 OSR 2.0 CD that was packaged with the unit into the CD-ROM Drive and boot the system.
2. At the DOS prompt enter `95-INST X:`, where X is the drive letter assigned to the CD-ROM. The necessary system files will be copied from the CD to the hard drive.

System Restoration

3. Once all the Windows 95 files have been copied to the hard drive, power down the system and replace the CD-ROM Drive Module with the Diskette Drive Module. Ensure that the Diskette Drive contains no diskettes and both CardBus slots are empty.
4. Power on the system. When prompted press the [fn] + [F3] key combination to enter the Setup Utility. Disable CD-ROM Boot Option. Save changes and Exit. The notebook will reboot. Refer to the DIGITAL HiNote Ultra 2000 User's Guide for detailed instructions on configuring the Setup Utility.
5. After disabling the CD-ROM boot option and the system is booted, the Windows 95 boot screen will appear. Hit any key to continue and then follow the on-screen instructions.
6. When prompted for type of installation, choose Typical.
7. When the Analyzing Your Computer window appears, do NOT select any additional devices for detection from the list provided.
8. When prompted with the Windows Components window, select the Most Common Components option. When Windows 95 installation is complete, any additional components can be installed using the Add/Remove Programs wizard via the Control Panel.
9. When prompted to make a Windows 95 Startup diskette, it is strongly recommended to do so. You will need a blank formatted 1.44 MB diskette for this operation.
10. At the completion of this phase of the Windows 95 installation, you will be prompted to select [Finish] to restart the computer so the changes can take effect.

System Restoration

11. The Windows 95 boot screen will appear and the system will continue the installation process. Follow the on-screen instructions and reboot the system when prompted.

System Restoration

Installing System Drivers

IDE CMD Driver

1. After the system reboots and the Windows 95 desktop appears, select Start from the Windows 95 task bar.
2. Select Run and when prompted with the Run dialog box enter C:\CMD\Setup and click [OK].
3. The program will ask you if you wish to continue the installation. Select [Yes] to continue. Depending on the speed of the system, the message "Saving the Windows 95 Registry" may pause a short while before continuing.
4. After all files are copied, the program will ask you if you wish to restart the notebook. Select [Yes].
5. After the notebook reboots, Windows 95 will declare that it found a new device and install the necessary drivers. When prompted, select [Yes] to reboot.

PCMCIA Drivers

1. When the notebook reboots and no new devices are detected, double-click the System icon in Control Panel. Then select the Device Manager tab.
2. Double-click on the Cirrus Logic PCIC compatible PCMCIA controller option listed under PCMCIA socket.
3. When the Properties window appears, remove the check mark in the box next to Disable in this hardware profile. Then click [OK].
4. Windows will present a dialog box to install the 32 bit PC Card drivers. Select [No], then click on the [Next] button.

System Restoration

5. A second dialog box will appear. Select [No] again then click on the [Next] button. Then click on the [Finish] button.
6. You will be prompted whether or not to reboot the notebook. Select [No].
7. Repeat steps 2-6 for each remaining device listed under PCMCIA socket. After the last device is configured accordingly, close all open windows and choose [Yes] when prompted to restart the system.

USR Winmodem

1. When Windows 95 reboots the US Robotics Inc., Sportster Winmodem Update Device wizard appears, do the following:
 - Click on the [Next] button.
 - Click on the [Other Locations] button.
 - Type in the path C:\Windows\Options\Cabs.
 - Click on [OK].
 - Click on the [Finish] button.
2. When prompted for the US Robotics Inc., Sportster Winmodem diskette, do the following:
 - Click on [OK].
 - Type in the path C:\Windows\Options\Cabs.
 - Click on [OK].
3. When the Windows Update Device Driver wizard appears to install the Wave Device for Voice Modem, do the following:
 - Click on the [Next] button. Wait for the window containing an [Other Locations] button to appear.
 - Click on the [Other Locations] button. The Select Other Locations window will appear.

System Restoration

- Type in the path C:\Windows\Options\Cabs
- Click on [OK].

System Restoration

- The Update Device Wizard will reappear. Click [Finish].
- It is now necessary to exit and reboot the system to complete the installation of the Winmodem.

Video, Audio & Joystick, and IR/USB Drivers

The installation of the Windows 95 operating system is now complete. Replace the Diskette Drive Module with the CD-ROM Drive and insert the DIGITAL HiNote Ultra 2000 System CD. Click on Start then Run and type X:\CDInstall, where X is the drive letter assigned to the CD-ROM drive. Follow the on-screen instructions to install the video, audio and joystick, and IR/USB drivers. The drivers need to be installed in the following order:

- Video
- Audio and Joystick
- IR/USB



NOTE: Applications and interactive User documentation can also be installed from the DIGITAL HiNote Ultra 2000 System CD. Refer to the section entitled DIGITAL HiNote Ultra 2000 System CD for an overview of the provided applications. Internet Explorer is not included on the System CD. If you wish to install this application, it can be download from Microsoft's web site: www.microsoft.com

Windows NT 4.0 System Restoration

This section details how to prepare a new or existing hard drive for Windows NT 4.0 installation and how to install drivers and software applications. To complete the process you must have the DIGITAL HiNote Ultra 2000 System CD and Windows NT CD which were packaged with your notebook.

System Restoration

This procedure assumes the DIGITAL HiNote Ultra 2000 Media Dock is not attached to the notebook.

1. Ensure that the notebook is powered off and insert the CD-ROM Drive Module.
2. Power on the system.
3. Enter the System Setup Utility by pressing the [fn] + [F3] key combination during POST (Power On Self Test).
4. Enable the CD-ROM Boot option in the System menu.
5. Place the Windows NT CD into the CD-ROM Drive.
6. Then select the Save & Reboot option from the Exit menu to save changes and exit the System Setup Utility.
7. The system will boot from the Windows NT CD and Windows NT Setup Program interface will appear.
8. Install Windows NT as described in the Microsoft Windows NT Workstation user's guide that was packaged with your system.
9. When Setup is complete, remove the Windows NT CD and insert the DIGITAL HiNote Ultra 2000 System CD. Click on Start then Run and type X:\CDInstall, where X is drive letter assigned to the CD-ROM drive. Follow the on-screen instructions to install the desired applications, interactive User documentation and all system drivers.



NOTE: Internet Explorer is not included on the System CD. If you wish to install this application, it can be download from Microsoft's web site:
www.microsoft.com

System Restoration

Re-installing & Upgrading System Drivers

The DIGITAL Portables Engineering Team is continuously testing the latest drivers available on the market. Due to the fast pace of improving technology, updated versions of the drivers may have become available on the market since the product has shipped.

To install the Audio, Video, and DEC ATAPI drivers, refer to the driver installation instructions found on the DIGITAL HiNote Ultra 2000 System CD for Windows NT. The drivers must be installed in the following order:

- DEC ATAPI
- Audio
- Video

The following instructions detail how to upgrade these drivers:

- CardWizard
- Power Profiler
- Docking Services
- USR Modem

When installing a new version of a driver for Windows NT, the existing version must first be removed, then the new version can be installed. To upgrade an existing driver:



NOTE: If installing a new CardWizard driver, remove all PC Cards from the CardBus slots. In some cases, the system must be turned off before removing the cards.

1. Open the Control Panel.
 - Click the Start button located on the Windows Task bar.
 - Click Setting.

System Restoration

- Click Control Panel.
2. Click on the Add/Remove Programs wizard.
 3. From the list of programs which can automatically be removed from the system, select the driver to be removed. (i.e. CardWizard, Dock Services, etc.)
 4. Click on the Add/Remove button.
 5. Once the Uninstall is complete, reboot the system.
 6. After Windows loads, navigate to the location of the new driver and initiate the setup program by clicking on the SETUP.EXE file.

GTX5233M/GTX5266M System Restoration

Windows 95 System Restoration

This section describes how to restore your system to its original factory-shipped configuration. If a Microsoft Windows 95 CD was packaged with your system, proceed to the section entitled Restoration using the Microsoft Windows 95 CD. If a DIGITAL Recovery CD was packaged with your system, proceed to the section entitled Restoration using the DIGITAL Recovery CD.

Restoration using the Microsoft Windows 95 CD

This section details how to format a new or existing hard drive, install Windows 95 SR2, drivers and software applications. To complete the process you must have the Microsoft Windows 95 CD and the DIGITAL HiNote Ultra 2000 System CD. This restoration procedure has been divided into the following sections and must be followed in the order given.

- Setup Utility Configuration Changes

System Restoration

- Formatting a Hard Drive
- Windows 95 Installation
- Installing System Drivers
 - IDE CMD Driver
 - PCMCIA Drivers
 - USR Winmodem Driver
 - Xircom Ethernet/Modem Combo Card Driver
 - Video, Audio/Joystick, and IR/USB Drivers

Setup Utility Configuration Changes

1. Insert the CD-ROM Drive module into the notebook's expansion bay and boot the system.
2. During the Memory Self-test, press the [fn] + [F3] key combination to enter the Setup Utility.
3. Load factory default settings and enable the CD-ROM Boot option in the System menu. Please refer to Chapter 4 of your User's Guide for detailed instructions on how to enable and disable Setup Utility options.
4. Place the DIGITAL HiNote Ultra 2000 System CD into the CD-ROM Drive.
5. Select the Save & Reboot option from the Setup Utility Exit menu. Note the drive letter assigned to the CD-ROM during bootup. The system will boot to the DIGITAL HiNote Ultra 2000 System CD.

System Restoration

Formatting the Hard Drive



CAUTION: This procedure will erase all data residing on the Hard Disk Drive. Before proceeding, ensure all important files are backed up.

This procedure assumes the DIGITAL HiNote Ultra 2000 Media Dock is not attached to the notebook.

1. When the system boots to the DIGITAL HiNote Ultra System CD, the system will prompt you whether or not you want to continue booting using this CD, press [Y]. Then a second screen will appear prompting you to press any key to continue, press the Space bar. An action menu will appear.
2. Select option 2 to initialize and partition a new hard drive using the FDISK utility.

When running FDISK, you will be prompted whether or not to enable large disk (FAT32) support. Choose No to enable FAT16. Also make sure you set the Active Partition flag to make it bootable.



NOTE: If you choose Yes to enable large disk support (FAT32) and want to install WinNT or a WIN95 non-SR2 operating system at a later time, you will have to repeat the complete Windows 95 System Restoration procedure and enable FAT16.

3. Reboot the system. When prompted press the Space bar to continue and the action menu will appear.
4. Choose option 3 to Format the C: partition of your hard drive.

System Restoration

5. To Format other drive partitions that may have been created in step 2, choose option 5 to exit to the DOS prompt. Enter the following command line: `FORMAT X: /U`, where X is the drive letter assigned to the drive partition to be formatted. Repeat this step for each additional partition.
6. To re-enter the bootable System CD menu, type `MENU` and press the Enter key.
7. Choose option 4, "Prepare to install Microsoft Windows from CD onto a newly formatted hard drive" to copy all necessary CD-ROM and system startup files to the C: drive.
8. Power down the system.

Windows 95 Installation

1. Place the Windows 95 OSR 2.0 CD that was packaged with the unit into the CD-ROM Drive and boot the system.
2. At the DOS prompt enter `95-INST X:`, where X is the drive letter assigned to the CD-ROM. The necessary system files will be copied from the CD to the hard drive.
3. Once all the Windows 95 files have been copied to the hard drive, power down the system and replace the CD-ROM Drive Module with the Diskette Drive Module. Ensure that the Diskette Drive contains no diskettes and both CardBus slots are empty.
4. Power on the system. When prompted press the `[fn] + [F3]` key combination to enter the Setup Utility. Disable CD-ROM Boot Option. Save changes and Exit. The notebook will reboot. Refer to the DIGITAL HiNote Ultra 2000 User's Guide for detailed instructions on configuring the Setup Utility.

System Restoration

5. After disabling the CD-ROM boot option and the system is booted, the Windows 95 boot screen will appear. Hit any key to continue and then follow the on-screen instructions.
6. When prompted for type of installation, choose Typical.
7. When the Analyzing Your Computer window appears, do NOT select any additional devices for detection from the list provided.
8. When prompted with the Windows Components window, select the Most Common Components option. When Windows 95 installation is complete, any additional components can be installed using the Add/Remove Programs wizard via the Control Panel.
9. When prompted to make a Windows 95 Startup diskette, it is strongly recommended to do so. You will need a blank formatted 1.44 MB diskette for this operation.
10. At the completion of this phase of the Windows 95 installation, you will be prompted to select [Finish] to restart the computer so the changes can take effect.
11. The Windows 95 boot screen will appear and the system will continue the installation process. Follow the on-screen instructions and reboot the system when prompted.

Installing System Drivers

IDE CMD Driver

1. After the system reboots and the Windows 95 desktop appears, select Start from the Windows 95 task bar.
2. Select Run and when prompted with the Run dialog box enter C:\CMD\Setup and click [OK].

System Restoration

3. The program will ask you if you wish to continue the installation. Select [Yes] to continue. Depending on the speed of the system, the message "Saving the Windows 95 Registry" may pause a short while before continuing.
4. After all files are copied, the program will ask you if you wish to restart the notebook. Select [Yes].
5. After the notebook reboots, Windows 95 will declare that it found a new device and install the necessary drivers. When prompted, select [Yes] to reboot.

System Restoration

PCMCIA Drivers

1. When the notebook reboots and no new devices are detected, double-click the System icon in Control Panel. Then select the Device Manager tab.
2. Double-click on the Cirrus Logic PCIC compatible PCMCIA controller option listed under PCMCIA socket.
3. When the Properties window appears, remove the check mark in the box next to Disable in this hardware profile. Then click [OK].
4. Windows will present a dialog box to install the 32 bit PC Card drivers. Select [No], then click on the [Next] button.
5. A second dialog box will appear. Select [No] again then click on the [Next] button. Then click on the [Finish] button.
6. You will be prompted whether or not to reboot the notebook. Select [No].
7. Repeat steps 2-6 for each remaining device listed under PCMCIA socket. After the last device is configured accordingly, close all open windows and choose [Yes] when prompted to restart the system.

System Restoration

USR Winmodem Driver

If your system features an internal USR Winmodem, follow the instructions below. If your system feature an internal Xicom Ethernet/Modem Combo card, go to the next section entitled Xircom Ethernet/Modem Combo Card Driver:

1. When Windows 95 reboots the US Robotics Inc., Sportster Winmodem Update Device wizard appears, do the following:
 - Click on the [Next] button.
 - Click on the [Other Locations] button.
 - Type in the path C:\Windows\Options\Cabs.
 - Click on [OK].
 - Click on the [Finish] button.
2. When prompted for the US Robotics Inc., Sportster Winmodem diskette, do the following:
 - Click on [OK].
 - Type in the path C:\Windows\Options\Cabs.
 - Click on [OK].
3. When the Windows Update Device Driver wizard appears to install the Wave Device for Voice Modem, do the following:
 - Click on the [Next] button. Wait for the window containing an [Other Locations] button to appear.
 - Click on the [Other Locations] button. The Select Other Locations window will appear.
 - Type in the path C:\Windows\Options\Cabs
 - Click on [OK].
 - The Update Device Wizard will reappear. Click [Finish].
 - It is now necessary to exit and reboot the system to complete the installation of the Winmodem.

System Restoration

System Restoration

Xircom Ethernet/Modem Combo Card Driver

If your system features an internal Xircom Ethernet/Modem Combo Card, do the following:

1. When Windows 95 reboots the Standard PCMCIA Card Modem Update Device wizard appears. Replace the Diskette Drive Module with the CD-ROM Drive, insert the DIGITAL HiNote Ultra System CD and then click [Next].
2. Do NOT click [OK] to install the driver found in the INF folder. Click [Other Locations].
3. In the Copying files from dialog box, type X:\drivers\win95\Xircom (where X is the drive letter assigned to the CD-ROM drive) and click [OK].
4. Click [Finish].
5. The Insert Disk window will appear prompting you to insert the disk labeled "Disk1: Installation Disk for Xircom CreditCard 10/100+Modem 56". Click [OK].
6. When the Copying Files window appears stating the file CEM56.SYS could not be found, type X:\drivers\win95\Xircom (where X is the drive letter assigned to the CD-ROM drive) and click [OK].
7. Windows will build a Drivers Information Database, then detect the Modem of Xircom CreditCard 100+56. A Location Information window will appear. Enter your area code and any other pertinent information. When finished, click [OK].
8. Windows will detect the Network of Xircom CreditCard 10/100+Modem 56. Then a Network window will appear stating that you must provide computer and workgroup names that will identify your computer on the network. Click [OK].

System Restoration

9. A new Network window will appear featuring three tabs. Enter the information required and click [OK]. If you are not sure which options pertain to your network configuration, contact your network administrator for assistance.
10. When prompted to insert the disk labeled 'Windows 95 CD-ROM', click [OK].
11. A Copying Files window will appear stating the file NETAPI.SDLL on the Windows 95 CD-ROM could not be found. In the Copying files from dialog box, type C:\windows\options\cabs and click [OK].
12. When the system finishes copying all the necessary files, you will be prompted to reboot the system. After the system reboots, the network connection will be operational.

Video, Audio & Joystick, and IR/USB Drivers

The installation of the Windows 95 operating system is now complete. If needed, replace the Diskette Drive Module with the CD-ROM Drive and insert the DIGITAL HiNote Ultra 2000 System CD. Click on Start then Run and type X:\CDInstall, where X is the drive letter assigned to the CD-ROM drive. Follow the on-screen instructions to install the video, audio and joystick, and IR/USB drivers. The drivers need to be installed in the following order:

- Video
- Audio and Joystick
- IR/USB



NOTE: Internet Explorer is not included on the System CD. If you wish to install this application, it can be download from Microsoft's web site:
www.microsoft.com

System Restoration

Restoration using the DIGITAL Recovery CD

A Recovery CD has been packaged with your system which will allow you to fully restore your system to its configuration as shipped from Digital. If for any reason you need to restore your system, do the following:



NOTE: The recovery procedure will erase all information on your C: Drive. Backup all pertinent data on your D: Drive (or E: Drive if available) prior to initiating the recovery process.

1. Power off the system and insert the CD-ROM Drive module into the expansion bay. Then place the Recovery CD into the CD-ROM Drive.
2. Boot the system and when prompted press the [fn]+[F3] key combination to enter the Setup Utility.
3. Load factory default settings then disable the Power Management features in the Power menu and enable the CD-ROM Boot option in the System menu. Then Save and Reboot. The system will boot to the Recovery CD. Please refer to Chapter 4 of your User's Guide for detailed instructions on how to enable and disable Setup Utility options.
4. When the Microsoft Windows 95 Startup Menu appears, select the desired language to be used during this process.
5. You will be prompted three times whether or not to continue the recovery process. Press [ctrl]+[C] at any prompt to exit this process or press the [Space] key to continue.



NOTE: Do not press any keys beyond this point. Pressing certain keys may cause recovery failure.

System Restoration

6. When prompted, remove the Recovery CD from the CD-ROM Drive and press the [ctrl]+[alt]+[del] key combination to restart the system.
7. The system will boot to the C: Drive. Follow the on-screen instructions to install Windows as usual.

Windows NT System Restoration

This section describes how to restore your system to its original factory-shipped configuration. If a Microsoft Windows NT 4.0 CD was packaged with your system, proceed to the section entitled Restoration using the Microsoft Windows NT CD. If a DIGITAL Recovery CD was packaged with your system, proceed to the section entitled Restoration using the DIGITAL Recovery CD.

Restoration using the Microsoft Windows NT CD

This section details how to prepare a new or existing hard drive for Windows NT 4.0 installation and how to install drivers and software applications. To complete the process you must have the DIGITAL HiNote Ultra 2000 System CD and Windows NT CD which were packaged with your notebook.

This procedure assumes the DIGITAL HiNote Ultra 2000 Media Dock is not attached to the notebook.

1. Ensure that the notebook is powered off and insert the CD-ROM Drive Module.
2. Power on the system.
3. Enter the System Setup Utility by pressing the [fn] + [F3] key combination during POST (Power On Self Test).
4. Enable the CD-ROM Boot option in the System menu.
5. Place the Windows NT CD into the CD-ROM Drive.

System Restoration

6. Then select the Save & Reboot option from the Exit menu to save changes and exit the System Setup Utility.
7. The system will boot from the Windows NT CD and Windows NT Setup Program interface will appear.
8. Install Windows NT as described in the Microsoft Windows NT Workstation user's guide that was packaged with your system.
9. When Setup is complete, remove the Windows NT CD and insert the DIGITAL HiNote Ultra 2000 System CD. Click on Start then Run and type X:\CDInstall, where X is drive letter assigned to the CD-ROM drive. Follow the on-screen instructions to install all system drivers, desired applications and interactive User documentation. The drivers must be installed in the following order:
 - DEC ATAPI
 - Audio
 - Video
 - Xircom
 - CardWizard
 - Power Profiler
 - Docking Services



NOTE: Internet Explorer is not included on the System CD. If you wish to install this application, it can be download from Microsoft's web site:
www.microsoft.com

System Restoration

Restoration using the DIGITAL Recovery CD

A Recovery CD has been packaged with your system which will allow you to fully restore your system to its configuration as shipped from Digital. If for any reason you need to restore your system, do the following:



NOTE: The recovery procedure will erase all information on your C: Drive. Backup all pertinent data on your D: Drive (or E: Drive if available) prior to initiating the recovery process.

1. Power off the system and insert the CD-ROM Drive module into the expansion bay. Then place the Recovery CD into the CD-ROM Drive.
2. Boot the system and when prompted press the [fn]+[F3] key combination to enter the Setup Utility.
3. Load factory default settings then disable the Power Management features in the Power menu and enable the CD-ROM Boot option in the System menu. Then Save and Reboot. The system will boot to the Recovery CD. Please refer to Chapter 4 of your User's Guide for detailed instructions on how to enable and disable Setup Utility options.
4. When the Microsoft Windows NT Startup Menu appears, select the desired language to be used during this process.
5. You will be prompted three times whether or not to continue the recovery process. Press [ctrl]+[C] at any prompt to exit this process or press the [Space] key to continue.



NOTE: Do not press any keys beyond this point. Pressing certain keys may cause recovery failure.

System Restoration

6. When prompted, remove the Recovery CD from the CD-ROM Drive and press the [ctrl]+[alt]+[del] key combination to restart the system.
7. The system will boot to the C: Drive. Follow the on-screen instructions to install Windows as usual.

Re-installing & Upgrading System Drivers

The DIGITAL Portables Engineering Team is continuously testing the latest drivers available on the market. Due to the fast pace of improving technology, updated versions of the drivers may have become available on the market since the product has shipped.

To install the Audio, Video, and DEC ATAPI drivers, refer to the driver installation instructions found on the DIGITAL HiNote Ultra 2000 System CD for Windows NT. If you reinstall all the drivers, then drivers must be installed in the following order:

- DEC ATAPI
- Audio
- Video
- Xircom

The following instructions detail how to upgrade these drivers:

- CardWizard
- Power Profiler
- Docking Services

When installing a new version of a driver for Windows NT, the existing version must first be removed, then the new version can be installed. To upgrade an existing driver:

System Restoration



NOTE: If installing a new CardWizard driver, remove all PC Cards from the CardBus slots. In some cases, the system must be turned off before removing the cards.

1. Open the Control Panel.
 - Click the Start button located on the Windows Task bar.
 - Click Setting.
 - Click Control Panel.
2. Click on the Add/Remove Programs wizard.
3. From the list of programs which can automatically be removed from the system, select the driver to be removed. (i.e. CardWizard, Dock Services, etc.)
4. Click on the Add/Remove button.
5. Once the Uninstall is complete, reboot the system.

After Windows loads, navigate to the location of the new driver and initiate the setup program by clicking on the SETUP.EXE file.

System Restoration

System BIOS 3

Introduction

This chapter provides information related to the system BIOS and its Setup program.

BIOS Setup Program

The BIOS (Basic Input and Output System) Setup Program is a utility that enables you to change the system configuration and tailor the operation of your notebook to suit individual work needs. It is a ROM-based (Read Only Memory) utility that displays the system's configuration status and allows you to set system parameters. The parameters are stored in non-volatile battery backed-up CMOS RAM, which saves information even when power is turned off. When power is restored, the system is configured with the values found in CMOS.



NOTE: The CMOS battery receives a charge when the system is operated on AC power. If the system is off for more than one year, the CMOS battery will drain and the ROM data will be lost.

The settings made in the Setup program affect how the notebook performs. It is important to try to understand all the Setup options and to make settings appropriate for the way you use the notebook.

System BIOS

System Setup Utility

To run System Setup:

1. Turn on or reboot your notebook computer.
2. During system boot, press [fn] + [F3] when prompted. After the prompt appears you have two to three seconds to press [fn] + [F3] and enter System Setup.

Helpful Hints

When updating your setup information there are several keyboard keys assigned to help you select menus and sub-menus, options, and to change option values.

Key	Function
→	Cursor keys move the cursor to the right and left
←	
↑	Cursor keys move the cursor up and down
↓	
Tab	Moves the cursor between menu items
Esc	Closes the current menu
Enter	Accepts the current selection
Space bar	Selects the current option or enables (check mark) or disables (no check mark) the option
Alt	Moves the cursor to the menu bar at the top of the screen

System BIOS

Updating Your Ultra 2000 Configuration

There are number of hardware options that can be configured on your notebook computer.

Feature	Selections
Power	Disabled Maximum Battery Life Maximum Performance Advanced Lid Switch Suspend Beep
System	Date/Time CD-ROM Boot Floppy Boot Quick Boot NUM Lock
Device	Serial Port Infrared Port Parallel Port Parallel Port Mode Audio Joystick
Security	Set User Password Set Supervisor Password Modify Password Mode Dock Security
Defaults	Save User Default Settings Load User Default Settings Load Factory Default Settings
Exit	Save Quit About

System BIOS

Power Options

The Ultra 2000 is factory-configured with preset power management values. If you are not an advanced user, start by using the default factory-configured power management settings. If you find that the factory settings do not fit your specific needs, enter the System Setup Program and make the needed changes.

Option	Settings	Comments
Disabled		Disables power management options supported by the system. Power management options are still available.
Maximum Battery Life		Maximizes the time between battery charges.
Maximum * Performance		Maximize performance while retaining some power savings for extending battery life.
Advanced		Use to set your own power saving options. Use this option only if you understand the effects various settings have on battery life and system performance. Refer to Advanced Power Management for a description of available settings.

continued

System BIOS

Option	Settings	Comments
Lid Switch	Suspend/ Resume* Desktop Mode	Configure how the notebook responds to opening and closing the LCD display panel. If Suspend/ Resume is selected, the computer enters Suspend Mode when the lid is closed and Resumes operation when the lid is opened. With Desktop is selected, the external video port is enabled when the lid is closed.
Suspend Beep	Disabled* (No Check Mark)	Allows you to enable or disable the suspend beep option. When enabled, the notebook emits two quick beeps before entering Suspend mode.

*Factory default setting

System BIOS

Advanced Power Options

These options are accessed by selecting the Advanced field.

Field	Settings	Comments
Hard Disk Timer	Disabled Selected times	Specify how long the hard disk must be inactive before it spins down. Press "Tab" to move between AC and Batterytimer entries .
Display Timer	Disabled Selected times	Specify how long the system must be inactive before the LCD backlight is turned off. Press "Tab" to move between AC and Batterytimer entries .
Standby Timer	Disabled Selected times	Specify how long the system must be inactive before Standby mode is entered. Press "Tab" to move between AC and Batterytimer entries . Note: The selected period for inactivity is measured from the last monitored system activity: a keystroke, mouse movement, or hard disk activity resets the timer.
Suspend Timer	Disabled Selected times	Specify how long the system is in Standby before entering Suspend mode. Press "Tab" to move between AC and Batterytimer entries . To resume operation from Suspend mode press the Suspend/Resume button.

*Factory default setting

System BIOS

System Options

Option	Settings	Comments
Date/Time	Current Date/Time	Sets your notebook to a specified date and time.
CD-ROM Boot	Enabled Disabled* (No Check Mark)	Enables or disables the ability to boot from a CD-ROM installed in the notebook. When enabled, the CD-ROM is the first device in the boot sequence.
Floppy Boot	Enabled* (Check Mark) Disabled	Enables or disables the ability to boot from the Diskette Drive. When enabled, the Diskette Drive is the second device in the boot sequence if CD-ROM Boot is enabled. If CD-ROM Boot is disabled the Diskette Drive is the first device in the boot sequence.
Quick Boot	Enabled Disabled* (No Check Mark)	Enables or disables a faster boot sequence. When enabled certain diagnostic tests are skipped to speed up system boot.
NUM Lock	Enabled Disabled* (No Check Mark)	Turns the embedded numeric key pad On or Off every time the system is booted.

*Factory default setting



NOTE: If the CD-ROM (if enabled) and hard disk drive boot devices are not found at system boot, the Diskette Drive is enabled as the boot device for the current boot sequence.

System BIOS

Device Options

Option	Settings	Comments
Serial Port	Disabled	Disables the onboard Serial Port. Enables and automatically configures the port.
	Auto*	Enables and allows you to manually configure the I/O address and Interrupt Request (IRQ) line for the port.
	Manual	
InfraRed Port	Disabled*	Disables the onboard Infrared Port. Enables and automatically configures the port.
	Auto	Enables and allows you to manually configure the I/O address and Interrupt Request (IRQ) line for the port.
	Manual	
Parallel Port	Disabled	Enables or disables the onboard Parallel Port.
	Auto*	Enables and automatically configures the port. Enables and allows you to manually configure the I/O address and Interrupt Request (IRQ) line for the port.
	Manual	

continued

System BIOS

Option	Settings	Comments
Parallel Port Mode	Standard	Selects proper mode for your printer or other parallel port device. See the device User's Guide for details.
	Bi-directional (PS/2)*	
	Enhanced Parallel Port (EPP) Extended Capabilities Port (ECP)	
Audio	Disabled	Disables onboard Stereo Audio.
	Auto*	Enables and automatically configures the onboard audio.
	Manual	Enables and allows you to manually configure the I/O addresses, Interrupt Request (IRQ) line, and DMA channel for onboard audio.
Joystick	Disabled	Enables or disables the Joystick Port on Multimedia Dock.
	Auto*	Enables and automatically configures the port.
	Manual	Enables and allows you to manually configure the port.

*Factory default setting



NOTE: It is recommended that you use Auto configure settings when available. If you manually configure a device, it is recommended that you use the "System" application located in the Windows "Control Panel."

System BIOS

Security Options

Option	Settings	Comments
Set User Password	Enter a password of up to eight alphanumeric characters.	Set a User Password required during: System Boot, Resume, and Undock operations. Dock Security and Modify Password Mode options select operations that will require a password. Be sure to write the password down and store it in a safe place.
Set Supervisor Password	Enter a password of up to eight alphanumeric characters.	Set a Supervisor Password required to enter System Setup. This password can also be used in place of the User Password. Be sure to write the password down and store it in a safe place.

continued

System BIOS

Option	Settings	Comments
Modify Password Mode	Password on Boot Only	When set, you will be prompted for a password on each system boot.
	Password on Boot and Resume	When set, you will be prompted for a password each time the system boots or resumes operation from Suspend mode.
Dock Security	Enabled (Requires a User password to be set.)	Enable password protection for the undocking mechanism on docked options. When enabled and a User Password is set, the option cannot be undocked unless the system is powered on and the User or Supervisor Password is supplied.
	Disabled*	If the system is not powered on, the option cannot be undocked when Dock Security is enabled.

*Factory default setting

System BIOS

Notebook Computer Security

Notebook Computer Security is important to avoid theft or accidental loss of your computer software and hardware. The DIGITAL HiNote Ultra 2000 provides the following levels of protection:

- User Password – Used to prevent unauthorized access to files on your notebook computer and unauthorized removal of a docked option.
- Supervisor Password – Used to prevent unauthorized access to your notebook computer's System Setup.
- Dock Security – Utilizes the User or Supervisor password to allow a docked device to be undocked. Requires a User password be set.



CAUTION

It is important that you remember your User and Supervisor Password after you have set one on your notebook computer. If you forget the password and want to have it reset, you must send the notebook computer along with proof of ownership to a DIGITAL Service Center for service.

System BIOS

User Password

Your notebook has a User password that you can set to prevent unauthorized access to your computer files and unauthorized removal of a docked option.

Setting/Changing the User Password

Perform the following steps to set or change the User password:

1. Turn on your notebook computer.
2. After POST successfully completes, press [fn] + [F3] to access System Setup.
3. The System Setup main menu appears on the screen.
4. Highlight the Security Setup menu and press [Enter].
5. Highlight the Set User Password field and press [Enter].
6. Type in up to an eight character User password and press [Enter].
7. To confirm, type in your User password a second time and press [Enter].



NOTE: If a password already exists, you will be prompted to enter the *old password* before a new one can be set.

8. Select the Exit menu and choose Save to save your new settings and exit System Setup.

Depending on the settings of the Password Mode and Dock Security features, your notebook computer will prompt you for a password each time it powers on, resumes operation, or when you request to remove a docked option.

System BIOS

Deleting the User Password

To delete a previously set User password and disable the feature:

1. Open the User password dialog box.
2. With the cursor in the "Enter new password" field, press [Enter].
3. The cursor will move to the "Re-enter new password" field. Press [Enter].
4. When the Notice dialog box appears notifying you that changes have been saved, press [Enter].
5. Select the Exit menu and choose Save to save your new settings and exit System Setup.

Supervisor Password

Your notebook computer has a Supervisor password option that you can set to prevent unauthorized access to the System Setup. If you set a Supervisor password, you need to enter it each time you want to access the System Setup.



NOTE: The Supervisor password can be used in place of the User password.

System BIOS

Setting/Changing the Supervisor Password

Perform the following steps to set or change the Supervisor password:

1. Turn On your notebook computer.
2. After Power On Self-Test (POST) successfully completes, press [fn] + [F3] to access System Setup.
3. The System Setup main menu appears on the screen.
4. Highlight the Security Setup menu and press [Enter].
5. Highlight the Set Supervisor Password field and press [Enter].
6. Type in up to an eight character Supervisor password and press [Enter].

To confirm, type in your Supervisor password a second time and press [Enter].



NOTE: If a password already exists, you will be prompted to enter the *old password* before a new one can be set.

7. Select the Exit menu and choose Save to save your new settings and exit System Setup.

When you access System Setup, you are prompted for the Supervisor password.

System BIOS

Deleting the Supervisor Password

To delete a previously set Supervisor password and disable the feature:

1. Open the Supervisor Password dialog box.
2. With the cursor in the "Enter new password" field, press [Enter].
3. The cursor will move to the "Re-enter new password" field. Press [Enter].
4. When the Notice dialog box appears notifying you that changes have been saved, press [Enter].
5. Select the Exit menu and choose Save to save your new settings and exit System Setup.

Dock Security

Setting a User password and enabling Dock Security password protects the undocking of options from the system. When a request is made to undock an option such as the DIGITAL HiNote Ultra Multimedia Dock, you will be prompted for a password. Enter either the User or Supervisor password (if set) to complete the undock request and undock the option.

System BIOS

Default Options

Option	Settings	Comments
Save User Default Settings		Stores the current Setup values as the user default values in non-volatile memory.
Load User Default Settings		Loads all values stored under User Defaults as the new system values.
Load Factory Default Settings		Loads all values to their Factory Default Settings.

Exit Options

Option	Settings	Comments
Save		Saves all Setup values and exit Setup.
Quit		Ignores all changes to Setup values and exits Setup.
About		Supplies some BIOS and system version information.

System BIOS

Restoring the Flash BIOS

To restore a corrupted Flash BIOS, a Crisis Recovery diskette is required.

To restore the Flash BIOS:

1. Turn the computer Off by pressing [fn] + Standby/Resume button.
2. Make sure the Diskette Drive Module is installed in the computer.
3. Enable Crisis Recovery mode by placing a jumper across resistor R744. This resistor is located in the expansion memory compartment on the bottom of the unit. To locate the resistor:
 - a) Place the unit in front of you with the bottom up and the battery closest to you.
 - b) Remove the cover on the memory compartment.
 - c) The resistor is located in the lower left corner of the memory compartment.
4. Place the Crisis Recovery disk in the drive.
5. Turn On the system. When the BIOS is restored, turn Off the system by pressing [fn] + Suspend/Resume button.
6. Remove the jumper across resistor R744.

Troubleshooting **4**

Introduction

This chapter provides a systematic method of isolating problems with the DIGITAL HiNote Ultra 2000 series of notebook computers. It is assumed that you have a basic understanding of DOS-based computer systems as well as a knowledge of standard troubleshooting procedures. This manual is written under the assumption that the problems are indeed related to the notebook computer itself. The improper usage of the system and application software problems are excluded in this chapter.

The system BIOS power on self-tests (POST) are integral to the system and detect certain errors with the system board. They use a series of beep codes to identify certain system board problems.

The troubleshooting procedures when followed step by step, can help isolate system problems.

Troubleshooting

Troubleshooting Tips

In general, troubleshooting involves an organized system of approach to problem solving. Try to isolate the problem and identify the defective device (hardware) or improper setting (software). When you have a problem, you should do a thorough visual inspection of the notebook computer.

- If none of the indicators are lit and you cannot hear the HDD spinning, then the notebook computer is probably not receiving power.
- Make sure the power cord is plugged in, and the AC adapter is securely connected. The LEDs on the AC adapter and the system should be on when connected to a working AC source.
- If you are using a power strip or surge protector, ensure that these devices are turned on.

Often problems are caused by improperly connected cables.

- If you are using peripherals such as the mouse or keyboard, make sure they are properly connected to their respective ports. Ensure that none of the connectors' pins are bent or broken.
- Check all cables connected to the notebook computer. If any are cut, frayed, or damaged in any way, replace them right away. Never use a damaged cable. A damaged cable is not only a fire hazard, it may also cause a short circuit, resulting in irreparable damage to the notebook computer.
- Check all internal connections to ensure that they are secure. Often problems can occur because a connection is loose or backwards.

Troubleshooting

Verify that all test equipment works before using it to test a malfunctioning component.

Verify that a component is the only malfunctioning part of the computer by replacing the malfunctioning component with a properly functioning one, and then try to run the system. For example, if you have tested an FDD in a test computer and found it to be bad, you should also try a good FDD in the malfunctioning FDD's computer to be sure that another component (such as the FDD controller) is not bad as well.

As with assembly and disassembly, make sure you have adequate lighting, the right tools, and a stable clean working environment.

The examples that follow provide useful tips and information that will help isolate and solve some of the more common problems that may be encountered.

System Start Failure

When you turn on the computer, the system hangs before completing or starting the POST (power on self test). Power supply failure, post failure, and boot-up failure can result in a system start failure.

Troubleshooting

Power Supply Failure

Problem	Troubleshooting Procedure
<p>You turn on the power switch and the following conditions apply:</p> <ul style="list-style-type: none">• There is no panel display• There is no noise coming from the HDD• The power indicator light is off.	<p>If you are operating the notebook computer using the battery:</p> <ul style="list-style-type: none">• The system could be in suspend. Press the Suspend/Resume button.• The battery connection is loose. Remove and reinstall the battery.• The battery power is depleted. Plug in the AC adapter, or replace the battery.• The battery needs to be reformed. Reform the battery.• The system could be experiencing a hang. Press the reset button (Figure 1-3). <p>If you are operating the notebook computer using the AC adapter:</p> <ul style="list-style-type: none">• Check that the AC adapter is plugged into an operational power supply. <p>Check that the AC adapter is connected securely to the notebook computer's AC adapter socket.</p>

continued

Troubleshooting

Problem	Troubleshooting Procedure
<p>You turn on the power switch and the following conditions apply:</p> <ul style="list-style-type: none">• There is no panel display• There is no noise coming from the HDD	<ul style="list-style-type: none">• Check to see if the Power LED on the computer is lit and the LED on the AC adapter is lit. If not lit, then the AC adapter is bad. Replace the AC adapter, and test the notebook computer again.• Press the Suspend/Resume button
<p>The power indicator light is off.</p>	<ul style="list-style-type: none">• Press the system's "Reset Button" located on the back of the unit between the serial and parallel port connectors.
<p>If the above items are functioning, then the notebook computer's internal power circuit is probably damaged. Check the power circuit of the notebook computer.</p>	

Troubleshooting

Boot-up Failure

Problem	Troubleshooting Procedure
You turn on the notebook computer and the following conditions apply: <ul style="list-style-type: none">• The notebook computer's power is on.• There is no screen display	<ul style="list-style-type: none">• System in Suspend Mode. Press the Suspend/Resume button.• System hung possibly hung after using a screen saver. Press the Reset button located on the back on the unit (Figure 1-3). <p>Check the DRAM connections to be sure that they are secure.</p> <ul style="list-style-type: none">• Check the LCD connections.• Check the system board power circuit.

Post Failure

Problem	Troubleshooting Procedure
You turn on the computer and the following happens: <ul style="list-style-type: none">• There is power to the system.• The HDD seems to be spinning.• The screen is operational, and error codes and messages are displayed.	<ul style="list-style-type: none">• A POST failure usually indicates a keyboard, memory, or HDD failure.• Check the error code or message against the error codes and messages in this chapter.

Cardbus Failure

Problem	Troubleshooting Procedure
The Cardbus slots do not work.	<ul style="list-style-type: none"> • Reseat the Cardbus assembly cable • Replace the Cardbus assembly • Replace the Motherboard

LCD Panel Failure

Problem	Troubleshooting Procedure
<p>You turn on the computer and one of the following conditions apply:</p> <ul style="list-style-type: none"> • The system is working, but there is no LCD panel display. • The system is working, but the LCD panel display vertical or horizontal lines. • The backlight comes on, but there is no display. • There is a display, but you have garbled characters on the screen. 	<ul style="list-style-type: none"> • Make sure that the LCD cable is securely connected to the Motherboard. • Make sure that the LCD cables are securely connected to the inverter. • If the cables are securely connected and the LCD still doesn't work, replace the LCD panel and test the system again. • If the display is garbled, verify the video setup in the operating system's Control Panel Display application. If these are correct, there is probably a VGA chip failure. Replace the motherboard.

Troubleshooting

CRT Failure

Problem	Troubleshooting Procedure
<p>The notebook computer has power, the notebook computer's LCD panel is working and one of the following conditions apply:</p> <ul style="list-style-type: none">• The notebook computer's LCD panel is working.• There is no display on the CRT.• The color of the CRT is wrong.• There is a display, but the display is not stable.	<ul style="list-style-type: none">• Make sure the CRT output is enabled.• Make sure that the CRT's power is on and the power cables are securely connected.• Make sure that the CRT to notebook computer cable connection is secure. Check the CRT port on the notebook computer to make sure the connection is secure, and that there are no damaged pins or connectors.• Make sure the settings in the operating system's Control Panel Display application are supported by the monitor.• If the CRT still doesn't work, change to a different CRT and try again.• If the color is bad, adjust the Monitor's color controls (if any).

Notebook Computer Keyboard Failure

Problem	Troubleshooting Procedure
<p>The notebook computer is fully powered-on. However, when pressing any of the keys on the keyboard, one of the following events occurs:</p>	<ul style="list-style-type: none"> • If incorrect characters are displayed, check the COUNTRY.SYS settings in the operating system to see if an incorrect language is being used by the system.
<ul style="list-style-type: none"> • Pressing on the key doesn't have any effect. 	<ul style="list-style-type: none"> • Make sure that the keyboard cable is securely connected into the keyboard connector.
<ul style="list-style-type: none"> • Incorrect characters are displayed on the screen. 	<ul style="list-style-type: none"> • Check the keyboard circuit. • Replace the keyboard and check again.
<ul style="list-style-type: none"> • One stroke of a key produces too many characters on the screen. 	<ul style="list-style-type: none"> • Replace the keyboard controller BIOS chip located in the memory compartment on the bottom of the system unit.

Troubleshooting

External Keyboard or PS/2 Mouse Failure

Problem	Troubleshooting Procedure
<p>The notebook computer's power is on, and the keyboard is working. One of the following conditions occurs:</p> <ul style="list-style-type: none">Pressing keys on the external keyboard has no effect.Pressing the key on the external keyboard gives incorrect characters.The mouse cursor on the screen doesn't move in conjunction with the external mouse.	<ul style="list-style-type: none">Make sure that the external mouse or keyboard's connection to the notebook computer's PS/2 mini-DIN connector is secure.Make sure the mouse trackball and position sensors are clean and free of dust.Replace the external mouse or keyboard and try again.If the system still doesn't work, test the mini-DIN keyboard circuit.If incorrect characters are displayed, check the COUNTRY.SYS settings in DOS to see if an incorrect language is being used by the system.

Troubleshooting

HDD Failure

Problem	Troubleshooting Procedure
When you try to access the HDD, one of the following conditions occurs:	<ul style="list-style-type: none">• Check to make sure that the BIOS settings are correct. Refer to Chapter 2 for BIOS information.• Make sure that the HDD connection is secure.
<ul style="list-style-type: none">• There is a message indicating that the HDD doesn't exist.	<ul style="list-style-type: none">• Install the HDD into another HiNote VP 550, VP 575 notebook computer and test it.
<ul style="list-style-type: none">• You can't read from the HDD.	<ul style="list-style-type: none">• If the HDD works in a test notebook computer, the HDD controller on the motherboard is probably bad. Test the motherboard.
<ul style="list-style-type: none">• You can't write to the HDD.	

FDD Failure

Problem	Troubleshooting Procedure
The notebook computer's power is on. The HDD is functioning correctly. When you try to access the FDD, one of the following conditions occurs:	<ul style="list-style-type: none">• Make sure the CD-ROM/FDD module is properly seated.• Switch to a different floppy disk and try again. Make sure that the floppy isn't write protected.
<ul style="list-style-type: none">• You can't read from the FDD.	<ul style="list-style-type: none">• Clean the FDD's heads.
<ul style="list-style-type: none">• You can't write to the FDD.	<ul style="list-style-type: none">• Change the CD-ROM/FDD module and test again.
<ul style="list-style-type: none">• You can't hear the FDD motor spinning, and the LED indicator light isn't on.	<ul style="list-style-type: none">• If the FDD is OK, then there is probably an I/O chipset failure. Replace the main board.

Troubleshooting

CD-ROM Failure

Problem	Troubleshooting Procedure
<p>The notebook computer's power is on. The HDD is functioning correctly. When you try to access the CD-ROM, one of the following conditions occurs:</p> <ul style="list-style-type: none">You can't read from the CD-ROM.You can't hear the CD-ROM motor spinning, and the LED indicator light isn't on.	<ul style="list-style-type: none">Make sure the CD-ROM/FDD module is properly seated.Switch to a different CD-ROM disk and try again.Clean the CD-ROM's lens.Change the CD-ROM/FDD module and test again.If the CD-ROM is OK, than there is probably an I/O chipset failure. Replace the main board.

Battery Failure

Problem	Troubleshooting Procedure
<p>The notebook computer's AC power works. When trying to use battery power, the notebook computer doesn't operate. However, when the AC Adapter is connected, the battery charge indicator flashes.</p>	<ul style="list-style-type: none">Make sure that the battery contacts are in good condition.Make sure that the battery terminals are clean. If need be, clean the terminals with contact cleaner.Form the battery and try again.Change the battery and try again.Make sure the AC power supply adapter and adapter cord) are OK. If they are not supplying the correct voltage, it could damage the system.

Touchpad Failure

Problem	Troubleshooting Procedure
The notebook computer's Touchpad does not work.	<ul style="list-style-type: none"> <li data-bbox="370 955 706 997">• Check the BIOS settings for the Touchpad. Refer to Chapter 2. <li data-bbox="370 1018 706 1060">• Check the Toucpad settings in the operating system's Control Panel. <li data-bbox="370 1081 706 1270">• Make sure the UMI cable connection to the Daughtercard is properly seated. This connector is located under the Keyboard Deck behind the Touchpad. Note: If both the Touchpad and modem do not work, this cable is most likely not connected. <li data-bbox="370 1281 706 1323">• Make sure the Touchpad cable is properly seated.

Troubleshooting

Internal Modem (UMI) Failure

Problem	Troubleshooting Procedure
The internal modem (if installed) does not work. You cannot make a connection to a phone line.	<ul style="list-style-type: none"><li data-bbox="418 953 699 1024">• Make sure the Modem Card, UMI adapter are properly seated.<li data-bbox="418 1045 699 1117">• Make sure the modem software is properly configured.<li data-bbox="418 1138 699 1243">• Verify that the modem port is enabled. This is done using the System icon in the Control Panel of the operating system.<li data-bbox="418 1264 699 1465">• Make sure the UMI cable is properly connected to the Daughtercard. This connector is located under the Keyboard Deck behind the Touchpad. Note: If both the Touchpad and modem do not work, this cable is most likely not connected.

External Audio Failure

Problem	Troubleshooting Procedure
No sound from external speakers connected to external audio port.	<ul style="list-style-type: none"> • Make sure the connections are properly seated. • Make sure power is applied to the speakers (if necessary). • Reseat the Audio Connector cable on the Daughtercard. Note: If this cable is not connected the internal speakers will not work.

Check Points and Error Messages

At the beginning of each POST routine, the BIOS outputs the test point error code to I/O address 80h. Use this code during troubleshooting to establish at what point the system failed and what routine was being performed.

If the BIOS detects a terminal error condition, it halts POST after:

- Issuing a terminal error beep code and
- Attempting to display the error code on upper left corner of the screen and on the port 80h LED display

If the system hangs before the BIOS can process the error, the code displayed at port 80h is that of the last test performed. In this case, the screen does not display the error code.

Troubleshooting

Beep Codes

The power on self-tests will issue a sequence of short and long beeps to indicate that an error has occurred. The following is a list of the beep code sequences and the error condition.

Beep Code Sequence	Error Condition
s,s,s,s	No RAM detected
s,s,s,l	RAM test failed
s,s,l,s	BIOS is not shadowed
s,l,s,s	BIOS Checksum bad
l,s,l,s	No CR code or CR is bad
s,s,s,s,s,s,s l,l,l,l l,l,l,l	Crisis Recovery required

s = short beep

l = long beep

Troubleshooting

Phoenix BIOS Test Points

The following is a list of the checkpoint codes written at the start of each test and the beep codes issued for terminal errors:

Code	Beeps	POST Routine Description
02		Verify Real Mode
04		Get CPU type
06		Initialize system hardware
08		Initialize chipset registers with initial POST values
09		Set in POST flag
0A		Initialize CPU registers
0C		Initialize cache to initial POST values
0E		Initialize I/O
0F		Initialize the local bus IDE
10		Initialize Power Management
11		Load alternate registers with initial POST values
12		Jump to UserPatch0
14		Initialize keyboard controller
16	2-2-3	BIOS ROM checksum
18		8254 timer initialization
1A		8237 DMA controller initialization
1C		Reset Programmable Interrupt Controller
20	3-1-1	Test DRAM refresh
22	3-1-3	Test 8742 Keyboard Controller

continued

Troubleshooting

Code	Beeps	POST Routine Description
24		Set ES segment register to 4 GB
28		Autosize DRAM
2A		Clear 512K base RAM
2C	3-4-1	Test 512K base address lines
2E	3-4-3	Test 512K base memory
30		Base 64K RAM Error
32		Test CPU bus-clock frequency
34		Test CMOS RAM
35		Initialize alternate chipset registers
37		Reinitialize the chipset
38		Shadow system BIOS ROM
39		Reinitialize the cache
3A		Autosize cache
3C		Configure advanced chipset registers
3D		Load alternate registers with CMOS values
40		Set Initial CPU speed
42		Initialize interrupt vectors
44		Initialize BIOS interrupts
46	2-1-2-3	Check ROM copyright notice
47		Initialize manager for PCI Option ROMs
48		Check video configuration against CMOS
49		Initialize PCI bus and devices

continued

Troubleshooting

Code	Beeps	POST Routine Description
4A		Initialize all video adapters in system
4C		Shadow video BIOS ROM
4E		Display copyright notice
50		Display CPU type and speed
51		Initialize EISA board
52		Test keyboard
54		Set key click if enabled
56		Enable keyboard
58	2-2-3-1	Test for unexpected interrupts
5A		Display prompt "Press F2 to enter SETUP"
5C		Test RAM between 512 and 640k
60		Test extended memory
62		Test extended memory address lines
64		Jump to UserPatch1
66		Configure advanced cache registers
68		Enable external and CPU caches
6A		Display external cache size
6C		Display shadow message
6E		Display non-disposable segments
70		Display error messages
72		Check for configuration errors
74		Test real-time clock

continued

Troubleshooting

Code	Beeps	POST Routine Description
76		Check for keyboard errors
7C		Set up hardware interrupt vectors
7E		Test coprocessor if present
80		Disable onboard I/O ports
82		Detect and install external RS232 ports
84		Detect and install external parallel ports
86		Re-initialize onboard I/O ports
88		Initialize BIOS Data Area
8A		Initialize Extended BIOS Data Area
8C		Initialize floppy controller
90		Initialize hard-disk controller
91		Initialize local-bus hard-disk controller
92		Jump to UserPatch2
94		Disable A20 address line
96		Clear huge ES segment register
98		Search for option ROMs
9A		Shadow option ROMs
9C		Set up Power Management
9E		Enable hardware interrupts
A0		Set time of day
A2		Check key lock
A4		Initialize typematic rate

continued

Troubleshooting

Code	Beeps	POST Routine Description
A8		Erase F2 prompt
AA		Scan for F2 key stroke
AC		Enter SETUP
AE		Clear in-POST flag
B0		Check for errors
B2		POST done-prepare to boot operating system
B4		One beep
B6		Check password (optional)
B8		Clear global descriptor table
BC		Clear parity checkers
BE		Clear screen (optional)
BF		Check virus and backup reminders
C0		Try to boot with INT 19
DO		Interrupt handler error
D2		Unknown interrupt error
D4		Pending interrupt error
D6		Initialize option ROM error
D8		Shutdown error

continued

Troubleshooting

Code	Beeps	POST Routine Description
DA		Extended Block Move
DC		Shutdown 10 error
The following Error Codes are related to the Boot Block in the Flash ROM:		
E2		Initialize the chipset
E3		Initialize refresh counter
E4		Check for Forced Flash
E5		Check HW status of ROM
E6		BIOS ROM is OK
E7		Do a complete RAM test
E8		Do OEM initialization
E9		Initialize interrupt controller
EA		Read in the bootstrap code
EB		Initialize all vectors
EC		Boot the Flash program
ED		Initialize the boot device
EE		Boot code was read OK

If the BIOS detects error 2C, 2E, or 30 (base 64K RAM error), it displays an additional word of information reflecting the bit or address line that failed. For example, if "2C 0002" is displayed, address line 1 (represented by bit one) has failed. If "2E 1020" is displayed, then data bits 12 and 5 have failed in the upper 16 bits.

The BIOS sends the same information to the port 80h LED display. The check point code is followed by a delay, the high order byte, another delay, and then the low order byte of the error. This is repeated continuously.

Warning Messages

The following is an alphabetic list of error and status messages which the PhoenixBIOS can generate and an explanation of each message. Many of the messages below refer to the built in Setup program.

Message	Description
nnnn Cache SRAM Passed	nnnn is the amount of system cache in kilobytes successfully tested.
Diskette drive A error	Drive A: is present but fails the BIOS POST diskette tests. Check to see that the drive is defined with the proper diskette type in Setup and that the diskette drive is attached correctly.
Entering SETUP	Starting Setup program
Extended RAM Failed at offset: nnnn	Extended memory not working or not configured properly.
nnnn Extended RAM Passed	nnnn is the amount of RAM in kilobytes successfully tested.
Failing Bits: nnnn	The hex number nnnn is a map of the bits at the RAM address (in System, Extended, or Shadow memory) which failed the memory test. Each 1 (one) in the map indicates a failed bit.
Fixed Disk 0 Failure or Fixed Disk 1 Failure or Fixed Disk Controller Failure	Fixed disk is not working or not configured properly. Check to see if fixed disk is attached properly. Run Setup to ensure that the fixed-disk type is correctly identified.
Incorrect Drive A type run SETUP	Type of floppy drive A: not correctly identified in Setup.

continued

Troubleshooting

Message	Description
Invalid NVRAM media type	Problem with NVRAM access.
Keyboard controller error	The keyboard controller failed test. You may have to replace keyboard or controller.
Keyboard error	Keyboard not working.
Keyboard error nn	BIOS discovered a stuck key and displays the scan code for the stuck key.
Keyboard locked Unlock key switch	Unlock the system to proceed.
Monitor type does not match CMOS	Run SETUP Monitor type not correctly identified in Setup
Operating system not found	Operating system cannot be located on either drive A: or drive C:. Enter Setup and see if fixed disk and drive A: are properly identified.
Parity Check 1 nnnn Parity error found in the system bus	BIOS attempts to locate the address but failed and display it on the screen.
Parity Check 2 nnnn Parity error found in the I/O bus	BIOS attempts to locate the address but failed and display it on the screen.
Press <F1> to resume, <F2> to Setup	Displayed after any recoverable error message: Press <F1> to start the boot process or <F2> to enter Setup and change any settings. <F2> Press <F2> to enter SETUP Optional message displayed during POST.

continued

Troubleshooting

Message	Description
Previous boot incomplete	Default configuration used
Previous POST did not complete successfully	POST loads default values and offers to run Setup. If the failure was caused by incorrect values and they are not corrected, the next boot will likely fail.
Real time clock error	Real-time clock fails BIOS test. May require board repair.
Shadow RAM Failed at offset: nnnn	Shadow RAM failed at offset nnnn of the 64k block at which the error was detected.
nnnn Shadow RAM Passed	Where nnnn is the amount of shadow RAM in kilobytes successfully tested.
System battery is dead - Replace and run SETUP	The CMOS clock battery indicator shows the battery is dead. Replace the battery and run Setup to reconfigure the system.
System BIOS shadowed	System BIOS copied to shadow RAM.
System cache error	Cache disable RAM cache failed the BIOS test. BIOS disabled the cache.
System CMOS checksum bad - run SETUP	System CMOS has been corrupted or modified incorrectly, perhaps by an application program that changes data stored in CMOS. Run Setup and reconfigure the system.

continued

Troubleshooting

Message	Description
System RAM Failed at offset: nnnn	System RAM failed at offset nnnn of in the 64k block at which the error was detected.
nnnn System RAM Passed	nnnn is the amount of system RAM in kilobytes successfully tested.
System timer error	The timer test failed. Requires repair of system board.
UMB upper limit segment address: nnnn	Displays the address of the upper limit of Upper Memory Blocks, indicating released segments of the BIOS which may be reclaimed by a virtual memory manager.
Video BIOS shadowed	Video BIOS successfully copied to shadow RAM.

FRU Replacement 5

Introduction

This chapter provides detailed procedures for replacing the DIGITAL HiNote Ultra 2000 series notebook computer Field Replaceable Units (FRUs). Unless otherwise noted the replacement procedures for the FRUs are the reverse of the removal procedures.



SHOCK OR STATIC SENSITIVE: Static electricity collects on non-conductors such as paper, cloth, or plastic. A static discharge can be damaging even though you often cannot see or feel it. To prevent damage to circuit boards and/or components:

- Before touching any circuit board or component, touch the metal frame of your workstation to discharge any static electricity.
- Keep circuit boards and components away from non-conductors.

FRU Replacement

Required Tools

You will need the following tools to remove and replace the HiNote Ultra 2000 series FRUs:

- #0 and #1 Phillips Head Screwdrivers
- 3/16 inch and 7/32 inch Nut Drivers

FRU Replacement

Field Replaceable Units

Key No.	Option Part Number	Orderable Spare Part	Mfg Part No.	Description
1	N/A	30-49174-01	3141BZ9070A	Assy, LCD Display 12.1" Lg/XGA
	N/A	30-49175-01	3111BZ9071A	Assy, LCD Display 14.1" LG/XGA
2	FR-PCPXF-AA	30-48364-01	6911B00005A	Li-Ion Battery Pack, 8C, Sony
	FR-PCPXF-AB	30-48365-01	6911G00004B	Li-Ion Battery Pack, 12C, Sony
3	N/A	30-48321-01	3111BZ008A	Assy, Floppy Disk Drive
4	N/A	30-48322-01	4975BZ9007A	Assy, CD-ROM, 11X, Toshiba (XM-1502B)
	N/A	30-49019-01	4975BZ9006A	Assy, CD-ROM, 20X, Toshiba (XM-1602B)
	N/A	30-49445-01	TBD	Assy, CD-ROM, 24X, Toshiba (XM-1602B)
5	N/A	30-48372-01	3823B32202A	Keyboard, US/American, Ultra 2000
6	FR-PCPMF-AA	30-48536-01	TBD	Memory Module 8MB SO-DIMM 144 Pin EDO 3.3v
	FR-PCPMF-AB	30-48537-01	TBD	Memory Module 16MB SO-DIMM 144 Pin EDO 3.3v
	FR-PCPMF-AC	30-48538-01	TBD	Memory Module 32MB SO-DIMM 144 Pin EDO 3.3v
	FR-PCPMF-AD	30-48539-01	TBD	Memory Module 64MB SO-DIMM 144 Pin EDO 3.3v

continued

FRU Replacement

Key No.	Option Part Number	Orderable Spare Part	Mfg Part No.	Description
7	FR-PCPRF-AA	30-48573-01	LGHDD21	2.1 GB Removable HDD, Ultra 2000
	FR-PCPRF-AB	30-49156-01	LGHDD30	3.2 GB Removable HDD, Ultra 2000
		30-49454-01	TBD	4.0 GB Removable HDD, Ultra 2000
8	N/A	29-33869-01	PF3WIS	12.1" XGA TFT Replacement On-Site Shell
	N/A	29-33870-01	PF4WIS	14.1" XGA TFT, 166MHz Replacement On-Site Shell
	N/A	29-33961-01	PF7WKS	14.1" XGA TFT, 233MHz Replacement On-Site Shell
	N/A	29-33962-01	PF6WIS	14.1" XGA TFT, 266MHz Replacement On-Site Shell
*	N/A	30-48342-01	6871B0008A4	UMI Adapter Connector, USR
*	N/A	30-49459-01	150-0985-001	UMI Adapter Connector, Xircom
*	N/A	30-48360-01	6871B9653A1	PCMCIA Modem Card, USR, NA/Asia
*	N/A	30-48361-01	150-0984-001	PCMCIA Modem Card, Xircom, NA/Asia
*	N/A	74-52296-01	3580BM2004C	Door, UMI & PCMCIA
*	N/A	74-52295-01	3580BM3005C	Memory Door

continued

FRU Replacement

Key No.	Option Part Number	Orderable Spare Part	Mfg Part No.	Description
*	N/A	30-48352-01	5006BM3006C	Cover, Hinge, R
*	N/A	30-48353-01	5006BM3005C	Cover, Hinge, L
*	FR-PCPEF-AC	30-48885-01	LGPR-00000	Ultra Enhanced Port Replicator N
*	FR-PCPDF-BW	30-48571-02	TBD	AC Adapter, without Power Cord, Ultra 2000
*	FR-PCPJF-W1	30-48572-01	LGDS-0000X	DIGITAL HiNote Ultra Multimedia Dock
*	FR-PCPZJ-AA	30-49015-01	E621	Airline/Car Power Adapter, Digital
*	N/A	17-04105-01	N/A	Power Cord, US/American

* Items marked with an asterisk (*) are not illustrated in Figure 5-1.

FRU Replacement

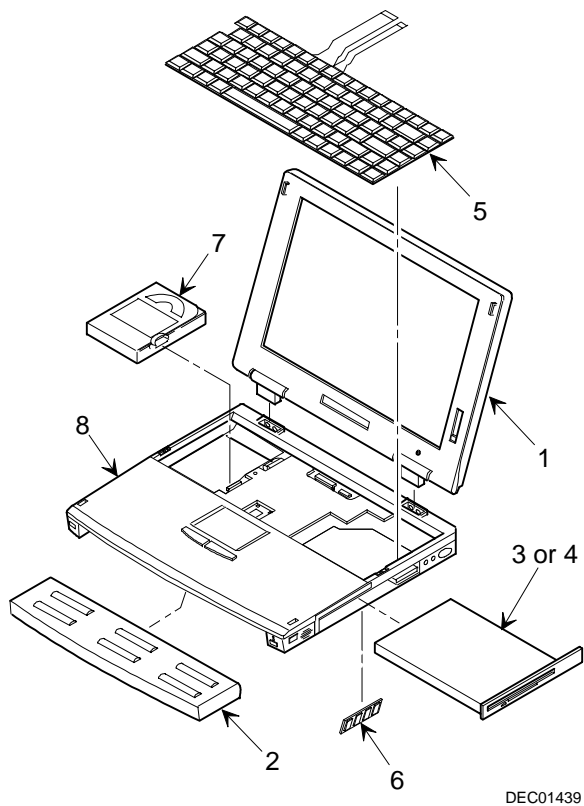

DEC01439

Figure 5-1. DIGITAL HiNote Ultra 2000 Series

Removing the Battery

The battery is located on the bottom of the system unit (Figure 5-2).

To remove the battery pack:

1. Close any open applications and shutdown the operating system.
2. Power Off the computer by pressing [fn] + the Standby/Resume button.
3. Press down on the battery in front of the latch and slide the latch in the direction shown
4. Remove the battery by lifting it up and away from the system unit (Figure 5-2).

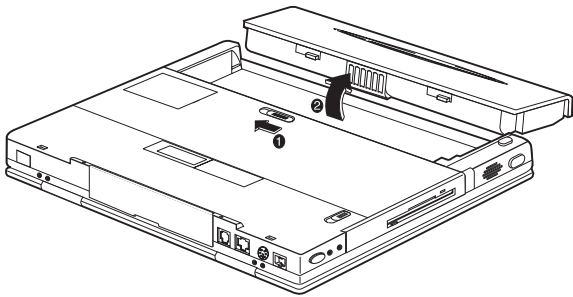

Figure 5-2. Removing the Battery

FRU Replacement

Removing the CD/FDD Module

To remove the 12x CD/FDD Combination module or supplementary battery:

1. Press in on the CD-ROM/FDD module and slide the latch in the direction shown in (Figure 5-3).
2. Slide the module out of the system unit.

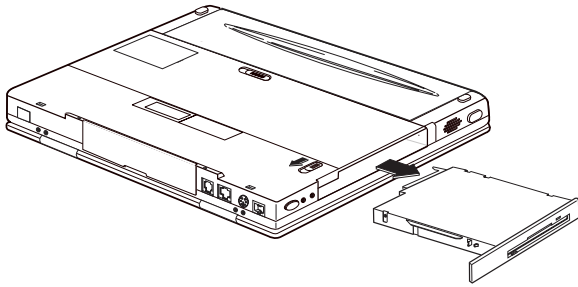

Figure 5-3. Removing the CD/FDD Module

Removing the Keyboard

To remove the keyboard:

1. Unlatch the keyboard by sliding the Keyboard latches toward the LCD display (Figure 5-4).
2. Carefully lift the keyboard up and rotate it toward the LCD display (Figure).



CAUTION

Be careful not to damage the flat cables that connect the keyboard to the notebook computer (Figure 5-5).

3. Release the keyboard cables from the connectors and slide the cables out of the connectors (Figure 5-4).

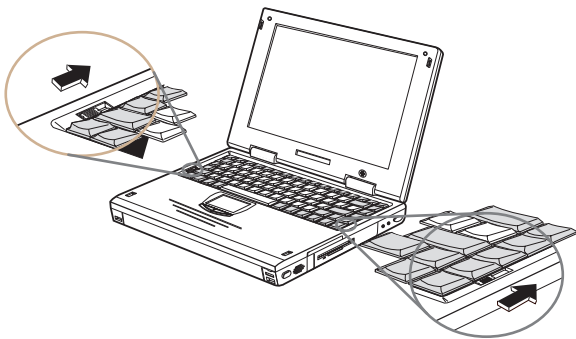

Figure 5-4. Releasing the Keyboard

FRU Replacement

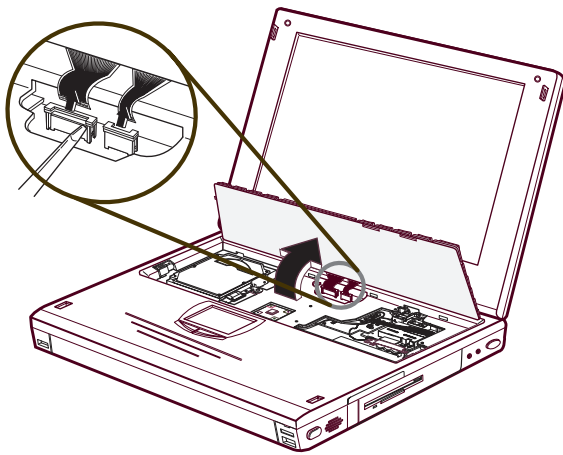

Figure 5-5. Removing the Keyboard

Removing the HDD Assembly

To remove the HDD:

1. Remove the keyboard (Figure 5-4 and 5-5).
2. Slide the latch that holds the hard drive in place to the unlocked position (Figure 5-6)..
3. Pull up on the attached ribbon loop to disconnect the drive and remove the drive from the system (Figure 5-7).



NOTE: If the HDD assembly is installed upside down, the screws on the assembly may get caught on some plastic inside the system. To remove the drive slide a piece of paper (yellow sticky) between the unit and the plastic and slide the HDD assembly out of the system.

FRU Replacement

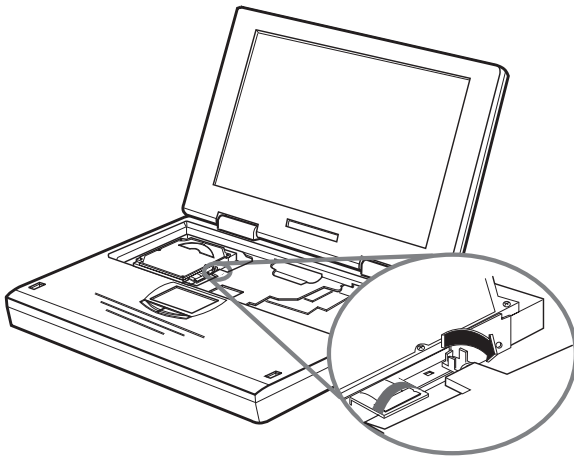

Figure 5-6. Releasing the HDD

FRU Replacement

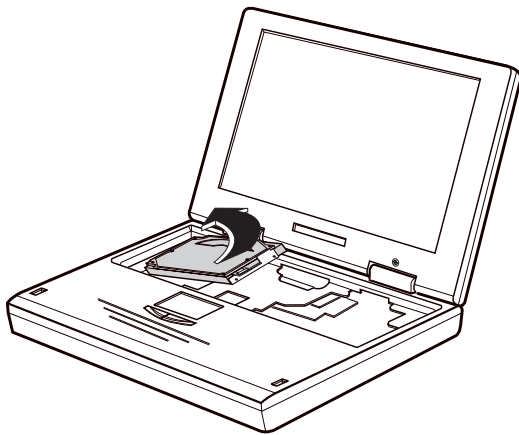

Figure 5-7. Removing the Hard Drive

Removing the Keyboard Deck and LCD Assembly

To remove the keyboard deck and LCD Assembly:

1. Remove the Battery (Figure 5-2).
2. Remove the CD-ROM/FDD Module (Figure 5-3).
3. Remove the Keyboard (Figure 5-4, Figure 5-5).
4. Remove the HDD (Figure 5-6, Figure 5-7).
5. Remove the UMI slot cover (Figure 5-8).

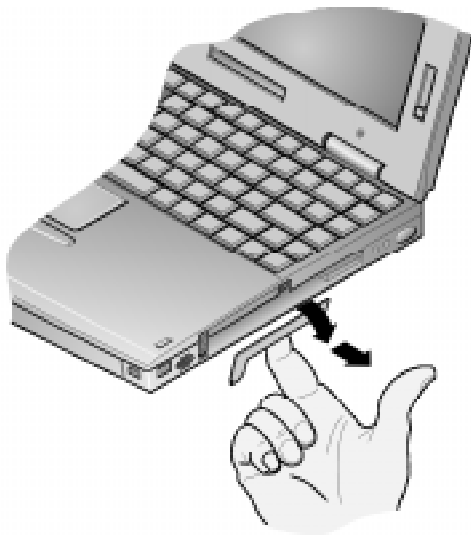

Figure 5-8. Removing the UMI Slot Cover

FRU Replacement

6. Remove the internal modem/combo PC Card. Press the eject button (Figure 5-9, step 1), the internal card will eject (Figure 5-9, step 2).



Figure 5-9. Removing the Internal Modem/Combo Card

7. Close the LCD Display and remove the two hinge covers (Figure 5-10). To remove the hinge covers:
 - a) Use a small pointed tool such as a pair of tweezers to release the inside edge of the hinge cover.
 - b) With your fingers, release the rest of the hinge cover and wiggle it to remove the hinge cover. Note: The left and right hinge covers are different.

FRU Replacement

8. Remove the four flat-head hinge screws (Figure 5-10).

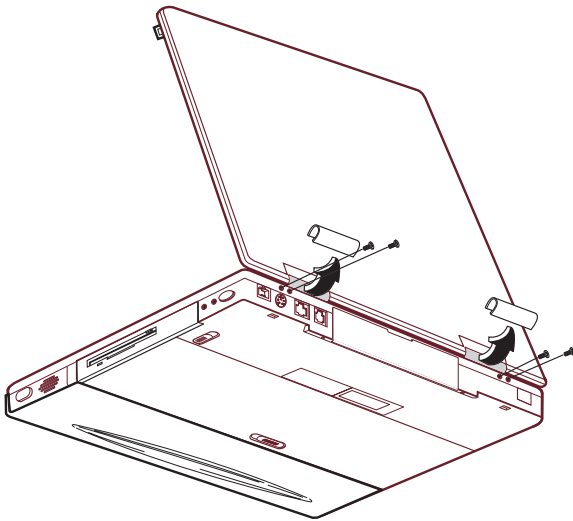

Figure 5-10. Removing Hinge Covers and Screws

9. Turn the system unit over so the bottom is up. Remove the two rubber feet and seven screws (Figure 5-11).
Note: one screw is located in the battery compartment.
10. Turn the system unit over so the top is up and open the LCD Display.
11. Remove the eight screws that hold the keyboard deck and LCD and Audio cables in place (Figure 5-11). Note: the LCD and Audio cables are secured to the top of the DC-to-DC Converter.
12. Disconnect the two LCD cables from the Motherboard and the Daughter card.

FRU Replacement

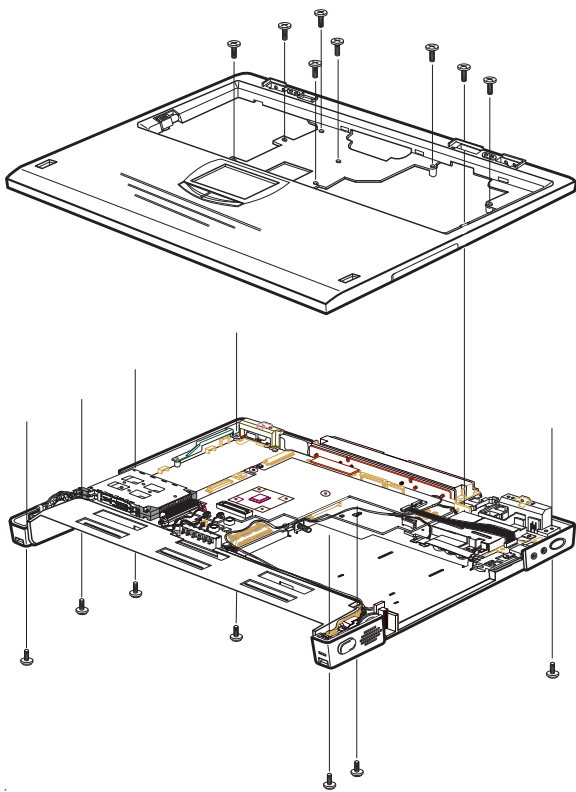

Figure 5-11. Removing Keyboard Deck Screws

FRU Replacement

12. Remove the four hinge screws at the back of the Keyboard Deck (Figure 5-12).
13. Grasp behind the Touchpad and pull up on the Keyboard Deck to release the UMI connector.



NOTE:

When reassembling the system, connect the UMI cable to Daughter card before replacing the Keyboard Deck.

Reconnect the two LCD cables.

Before replacing the Keyboard Deck screws, attach the AC adapter and verify that the system powers up.

Make a visual inspection of the connections before replacing the screws.

14. Flip the PC Card ejectors out and lift the LCD Display and Keyboard Deck up and away from the rest of the system unit.
15. To separate the Keyboard Deck and LCD Display, carefully maneuver each cable through its the opening in the Keyboard Deck.



CAUTION

Be careful not to crease the cable when you fold it over.

FRU Replacement

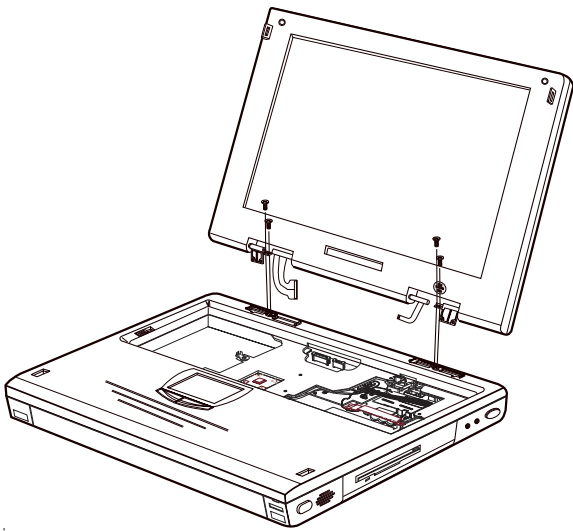

Figure 5-12. Removing LCD Assembly Hinge Screws

FRU Replacement

Shell Installation Instructions



IMPORTANT: This notice contains information that is important for configuring a replacement HiNote Ultra 2000 series "Shell" at a customer site.

The HiNote Ultra 2000 series notebook computer "shell," also known as a replacement foundation, is supplied for field use. It minimizes field disassembly of a customer system, allowing efficient onsite repair. Refer to the previous FRU replacement procedures for complete information.

FRU Replacement

Prior to Disassembly

1. A paper label is supplied on the bottom of your replacement "Shell." Edit the label by adding the appropriate information from the customer's system. This information is necessary for warranty, service and tracking purposes.

This notebook was exchanged by Digital Multivendor Customer Service Personnel as part of an hardware service call.

Original Serial No.: 2U72301204

Original Model No.: FR-PD4WI-AA

Call Log #: C709220176 Date: 9/24/97

Record the customer's,

- Original Serial number
- Original Model number
- Call log number
- Service date

Figure 5-13. Enter Customer Data on the Shell Label

2. Attach a field failure tag to the failed "Shell" identifying the failure mode and return it complete, for repair using normal procedures.

FRU Replacement

Disassembly Instructions

The following parts will be removed from the customer's system and retained for installation in the replacement "Shell" (see Figure 5-14).

1. Remove the primary battery.
2. Remove the combo FDD and CD drive assembly.
3. Slide the keyboard latches, raise the keyboard toward the LCD.
4. Remove the keyboard cables from the locking connectors.
5. Remove the keyboard.
6. Slide the HDD locking latch to the unlocked position, pull the ribbon loop to remove the HDD assembly.
7. Remove the internal modem/combo card.
8. Remove any additional PCMCIA and memory daughter cards

Customer System Re-configuration

On the replacement "Shell," in reverse order, add all the parts that were removed from the defective HiNote Ultra 2000.

FRU Replacement

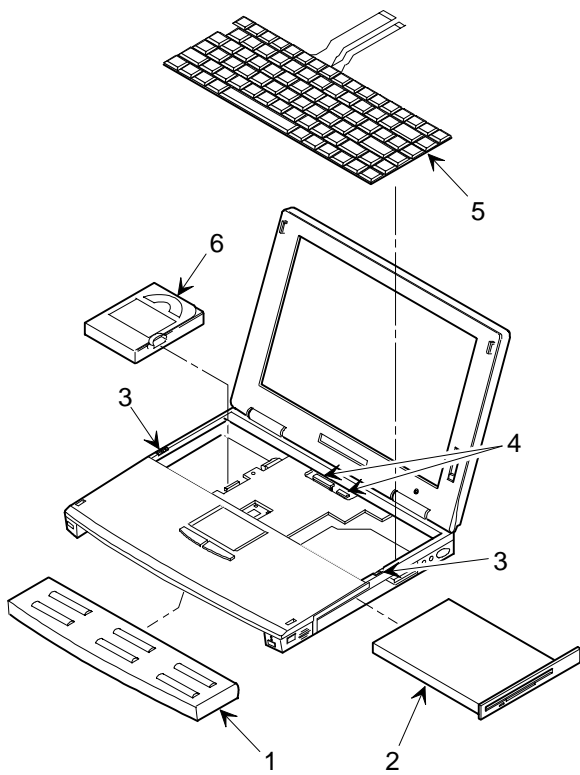

DEC01438

Figure 5-14. DIGITAL HiNote Ultra 2000

FRU Replacement

Specifications **A**

VTX5166M & GTX5166M Specifications

System Feature	Model	
	VTX5166M - 2.1GB - 12.1"	GTX5166M - 2.1GB - 14.1"
CPU Intel Pentium	166 MHz MMX	166 MHz MMX
LCD	12.1" XGA TFT	14.1" XGA TFT
HDD	2.1 GB	2.1 GB
Upgradeable HDD	Yes	Yes
L2 Cache	512KB	512KB
Base RAM	32MB – EDO 3.3v	32MB – EDO 3.3v
Maximum RAM	144MB	144MB
RAM Expansion	Single 144 pin SO- DIMM 3.3v self- refresh	Dual 144 pin SO- DIMM 3.3v self- refresh
Video RAM	2MB	2MB
Operating System	Windows 95 or Windows NT 4.0	Windows 95 or Windows NT 4.0
Warranty	3 years	3 years
Battery	Lilon – 8 cell 36Whrs	Lilon – 12 cell

Specifications

System Feature	Model	
	VTX5166M - 2.1GB - 12.1"	GTX5166M - 2.1GB - 14.1"
	54Whrs	
Audio	Yes	Yes
CardBus/Zoomed Video	Supported	Supported
Fast IR (4 Mbps)	Yes	Yes
Integrated CD-ROM	11X	20X
Integrated Modem	Optional*	USR 56Kbps
Pointing Device	Touch pad	Touch pad
DIGITAL HiNote Ultra Enhanced Port Replicator	Optional	Optional
DIGITAL HiNote Ultra Multimedia Dock	Optional	Optional

* Available separately as a customer installable option.

Physical Specifications

Feature	Model	
	VTX5166M - 2.1GB - 12.1"	GTX5166M - 2.1GB - 14.1"
Size	9.7" x 12" x 1.25"	9.7" x 12" x 1.4"
Weight (no FDD or CD-ROM)	5.2 lbs. (approximate)	6.2 lbs. (approximate)
Weight (with FDD)	5.6 lbs. (approximate)	6.6 lbs. (approximate)
Weight (with CD-ROM)	5.85 lbs. (approximate)	6.85 lbs. (approximate)

Specifications

GTX5233M & GTX5266M Specifications

System Feature	Model	
	GTX5233M - 4.0GB - 14.1"	GTX5266M - 4.0GB - 14.1"
CPU Intel Pentium	233 MHz MMX	266 MHz MMX
LCD	14.1" XGA TFT	14.1" XGA TFT
HDD	4.0 GB	4.0 GB
Upgradeable HDD	Yes	Yes
L2 Cache	512KB	1MB
Base RAM	32MB – EDO 3.3v	32MB – EDO 3.3v
Maximum RAM	144MB	144MB
RAM Expansion	Single 144 pin SO– DIMM 3.3v self- refresh	Dual 144 pin SO– DIMM 3.3v self- refresh
Video RAM	4MB	4MB
Operating System	Windows 95 or Windows NT 4.0	Windows 95 or Windows NT 4.0
Warranty	3 years	3 years
Battery	Lilon – 12 cell 54Whrs	Lilon – 12 cell 54Whrs
Audio	Yes	Yes
CardBus/Zoomed Video	Supported	Supported
Fast IR (4 Mbps)	Yes	Yes
Integrated CD-ROM	20X	24X
Integrated Modem/Ethernet	56Kbps Modem 10/100 Ethernet	56Kbps Modem 10/100 Ethernet
Pointing Device	Touch pad	Touch pad

Specifications

	Model	
System Feature	GTX5233M - 4.0GB - 14.1"	GTX5266M - 4.0GB - 14.1"
DIGITAL HiNote Ultra Enhanced Port Replicator	Optional	Optional
DIGITAL HiNote Ultra Multimedia Dock	Optional	Optional

Physical Specifications

	Model	
Feature	GTX5233M - 4.0GB - 12.1"	GTX5266M - 4.0GB - 14.1"
Size	9.7" x 12" x 1.4"	9.7" x 12" x 1.4"
Weight (no FDD or CD-ROM)	6.2 lbs. (approximate)	6.2 lbs. (approximate)
Weight (with FDD)	6.6 lbs. (approximate)	6.6 lbs. (approximate)
Weight (with CD-ROM)	6.85 lbs. (approximate)	6.85 lbs. (approximate)

Specifications

Environmental Specifications

Parameter	Value
Temperature	
Operating	0° C to 40° C (32° F to 122° F)
Nonoperating	-20° C to 60° C (-4° F to 140° F)
Humidity (noncondensing)	
Operating	20% to 80%, Max wet bulb 35° C
Nonoperating	5% to 95%, Max wet bulb 35° C
Altitude	
Operating	Sea level to 3,040m (8,000 ft)
Nonoperating	Sea level to 12,160m (40,000 ft)
Vibration	
Operating	Minimum of 35mm or 1.0 G (0 to peak), 5 - 500 Hz, per IEC-68-2-6
Nonoperating	Minimum of 50mm or 1.5 G (0 to peak), 5 - 500 Hz, per IEC-68-2-6
Shock	
Operating	10G for 11ms half sine
Nonoperating	100G for 11ms half sine
Acoustic noise (A weighted sound power level, Lwa, per ISO 7779)	High Frequency Tones < (25 + 5(f - 14)) (f = frequency in khz)
Idle mode:	3.8 Bels
HHD operating:	3.9 Bels
Keyboard operating:	5.0 Bels

Specifications

Device Mapping *B*

Memory Map

Range	Name	Function
0h to 9FFFFh	640KB System Memory	System Memory Space
A0000h to BFFFFh	128K Video Memory	Graphics Display Memory Buffer
C0000h to CAFFFh	44KB Video BIOS ROM	Shadow BIOS of VGA
CC000h to CD7FFh	6K CD Boot ROM	CD Boot
CD800h to CDFFFh	2K EPP Bios	Enhance Parallel Port
E8000h to FFFFFh	96KB PCI, PnP, and System ROM	BIOS of System
100000h to 8FFFFFFh	Additional Memory Space	Extended Memory Space, Size from 8MB up to 144MB

Device Mapping

DMA Channel Assignments

Channel	Controller	Function
0	1	Parallel Port ECP (if enabled)
1	1	Sound
2	1	Diskette controller
3	1	Serial IR (if enabled)
4	2	Cascade DMA
5	2	Not used
6	2	Not used
7	2	Not used

Notebook Computer Interrupt Levels

IRQ	Normal Assignments (FIS)
0	System Timer
1	Keyboard
2	Programmable Interrupt Controller
3	Serial Port Com2
4	Serial Port Com1
5	Audio
6	Floppy Disk Controller
7	Parallel Port LPT1
8	Real time clock
9	PCI Cardbus Controller
10	PCI Cardbus Controller
11	USB and Cardbus Controller (Multimedia dock)
12	Track Pad, PS/2 Mouse
13	Numeric data processor
14	Hard disk controller
15	Secondary Hard Disk Controller and Cardbus (Multimedia dock)

Device Mapping

I/O Address Map

Range (hexidecimal)	Function
000 - 00F	DMA controller A
020 - 021	Master interrupt controller
024	Index register - system board
026	Data register - system board
040 - 043	Interval timer
060 - 06F	Keyboard controller
070 - 07F	Real-time clock (RTC), NMI
080 - 08F	DMA page register
0A0 - 0A1	Slave interrupt controller
0C0 - 0CF	DMA controller B
0F0	Clear math coprocessor
0F1	Reset math coprocessor
0F8 - 0FF	Math coprocessor
150 - 157	ESS 1878 control interface
170 - 177	Secondary IDE controller
1F0 - 1F7	IDE controller
201	MIDI/Joystick
220-22F	On-board Audio (ESS 1878)
278 - 27F	LPT2

continued

Device Mapping

Range (hexidecimal)	Function
2E8 - 2EF	COM4
2F8 - 2FF	COM2
330-331	MPU 401 Audio
378 - 37F	LPT1
388 -38B	FM synthesizer Audio
3B0 - 3BB	Mono VGA registers
3BC - 3BE	LPT3
3C0 - 3CF	VGA registers
3D0 - 3DF	Color VGA registers
3E0 - 3E1	PCMCIA controller
3E8 - 3EF	COM 3
3F0 - 3F7	Diskette controller
3F6 - 3F7	IDE controller (alt status, device address)
3F8 - 3FF	COM1
CF8 - CFF	Cardbus PCI port interface

*Enabled and disabled using the Setup Utility or Windows 95