

Prioris™

digital™

Server Installation

WITH ServerWORKS™ QUICK LAUNCH

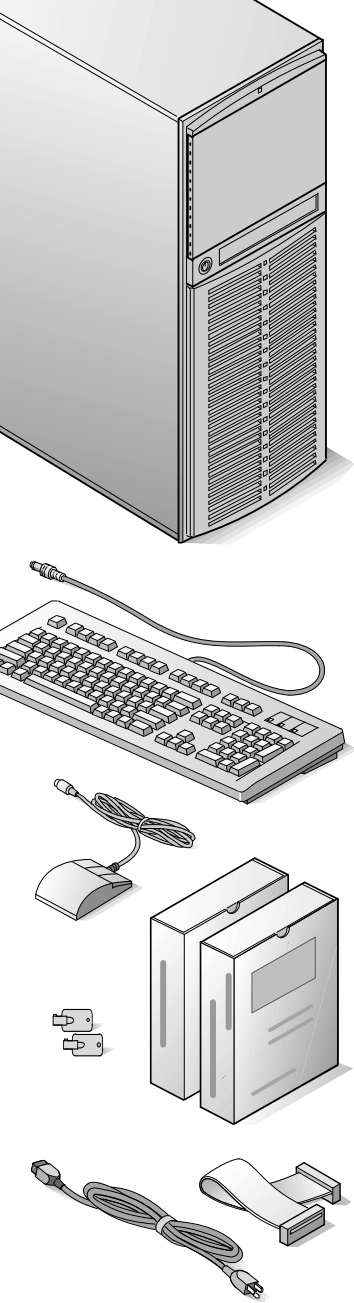

Thank You

... for purchasing a Digital Prioris server.

The Prioris family represents Digital's continued commitment to Uncompromising Quality, backed by award-winning Customer Service and Support. The following procedures will help you easily set up your server's hardware and software.

ServerWORKS Quick Launch

ServerWORKS **Quick Launch** delivers unparalleled achievement in streamlining the installation and configuration of hardware components and network operating system software on Digital's Prioris™ line of servers. Quick Launch combines an intuitive interface and versatile, time saving features to produce a consistent and accurate installation optimized for Digital's extremely powerful and highly acclaimed Prioris servers.

In addition to its automated yet extensible method of express installations for Network Operating Systems, Quick Launch provides a comprehensive archive of server documentation, troubleshooting assistance, and indispensable configuration utilities; all on one bootable CD!

Before you Begin

Select a suitable area for assembly and use. Ensure that your workspace:

- Is located next to electrical outlets and a telephone jack
- Is free from excessive heat, dust, and direct sunlight
- Allows at least 7 inches of clearance on all sides for proper air flow

See "Technical Specifications" in your User's Guide for temperature and humidity information.

If you do not wish to install the server yourself, contact Digital Customer Service. A Customer Service Technician can install the server for you.

1 *Unpack your server and check the parts*

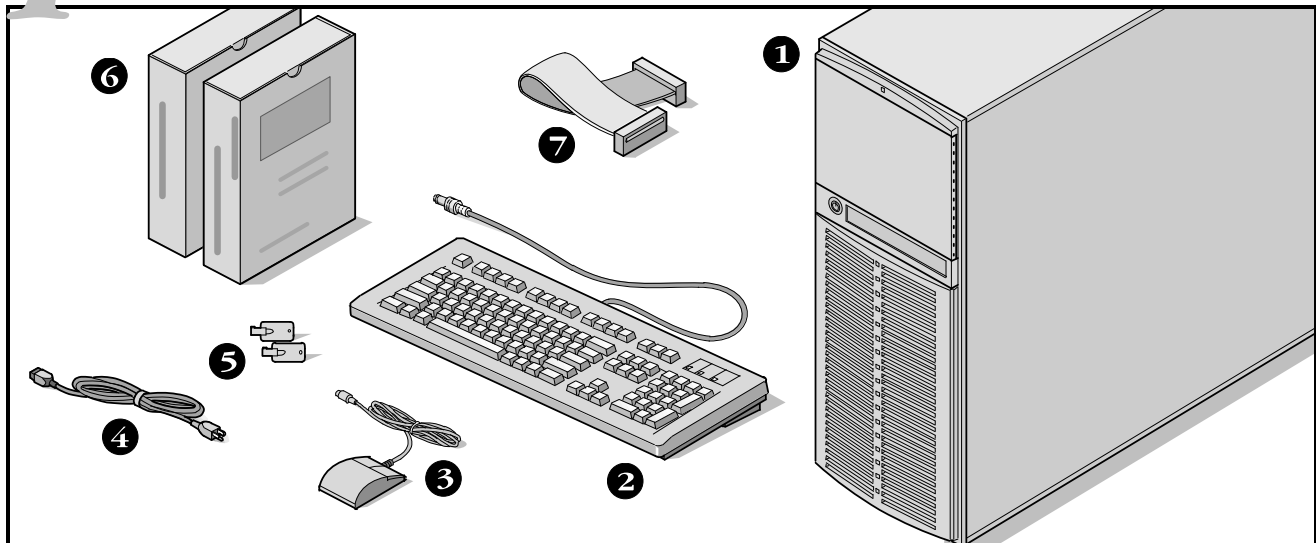

Unpack and identify your server's components.

- ① Prioris server
- ② Keyboard
- ③ Mouse
- ④ Power cord
- ⑤ Server keys
- ⑥ Server software and documentation kits
- ⑦ VGA feature connector cable

The ServerWORKS software kit includes:

- ServerWORKS Quick Launch kit: ServerWORKS Quick Launch CD-ROM disk and Reference Guide.
- ServerWORKS Manager kit: ServerWORKS Manager software and documentation.

The Prioris Server documentation kit includes:

- This Installation Guide, User's Guide, Documentation Overview, Options Manuals, Warranty and Service Information, Diagnostic User's Guide, and Registration Card.

2 *Install any internal options*

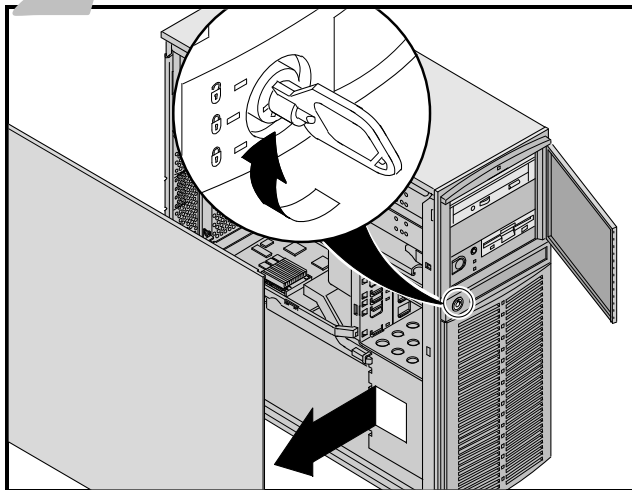

If you have options to install, install them now.

1. Unlock security door
2. Unlock side panel
3. Remove side panel
4. Install options

Refer to these chapters in the User's Guide for detailed information on:

- Expanding Your Server
- Server Utilities

Also, refer to the documentation that came with the option kit for specific installation instructions.

NOTES

ISA cards should be installed after you run the System Configuration Utility (SCU) in Step 6 or 7.

Before touching any circuit board or component, wear an anti-static wrist strap, properly grounded to the server chassis, or touch the metal frame to discharge any static electricity.

If your server was not pre-configured at the factory, you need the following minimum requirements to proceed with the server installation:

- 16 MB of RAM
- SVGA monitor
- 540 MB minimum hard disk drive
- Network card
- Two or three button mouse
- CD-ROM drive attached to the bootable SCSI controller
- Keyboard

3 *Connect the cables*

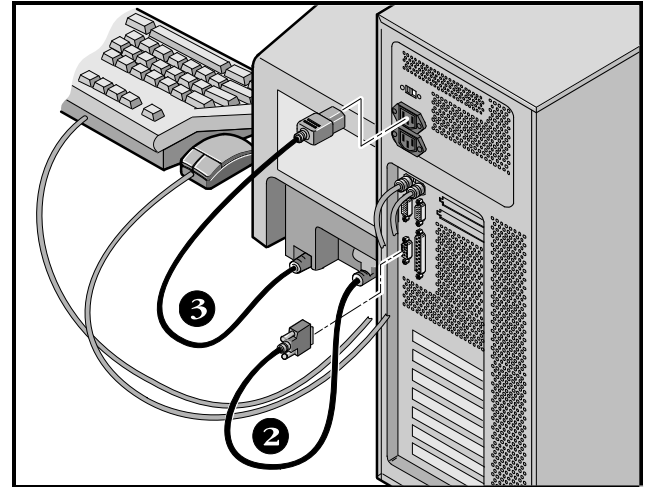
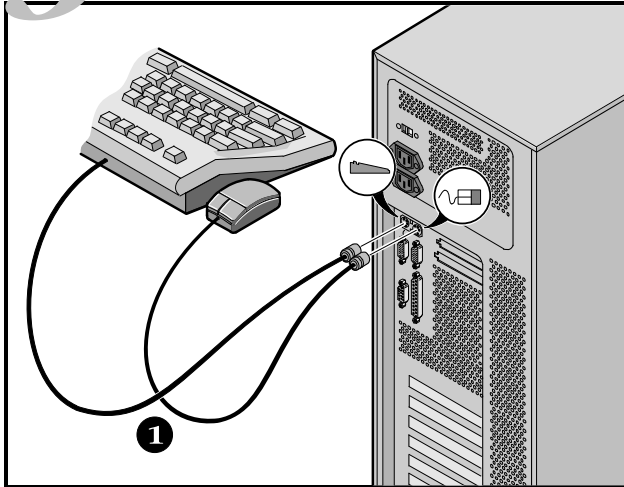

1. Connect the mouse and keyboard cables into the corresponding connectors at the back of the server.
2. Place your monitor near your server. Connect the monitor signal cable to the back of the monitor and then connect it to the matching connector at the back of your server.
3. Connect the monitor power cord to the back of the monitor and then connect it to the matching connector at the back of your server or into a wall outlet .
4. If you installed a network card, connect the network cable now. Refer to the manufacturer's documentation for more information.

NOTE

Some large screen monitors (17-inch diagonal and over) require more power than the server's auxiliary ac outlet can supply. These monitors will have power cords that must be connected directly into a wall outlet.

4 *Connect the power cord*

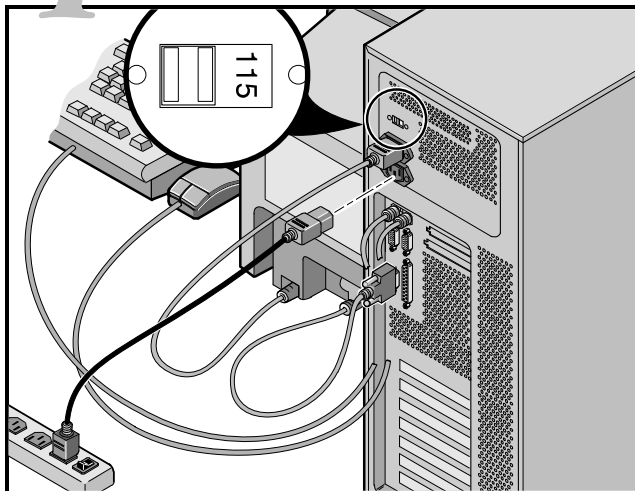

Connect the ac power cord to the server, then to your power outlet.



CAUTION

The voltage select switch must match the voltage supplied by your outlet. In North American countries, 115 V ac current is common. In other countries, 230 V ac current is common. Make sure that the voltage select switch is set to the correct voltage. If it is not set correctly, you can damage your server. The voltage select switch is located above the monitor power outlet.

Do not attempt to modify or use an external 100 V ac (Japan only) or 115 V ac power cord for 220-240 V ac input power. Modifying either power cord can cause severe equipment damage.

5

Turn on the monitor and then the server

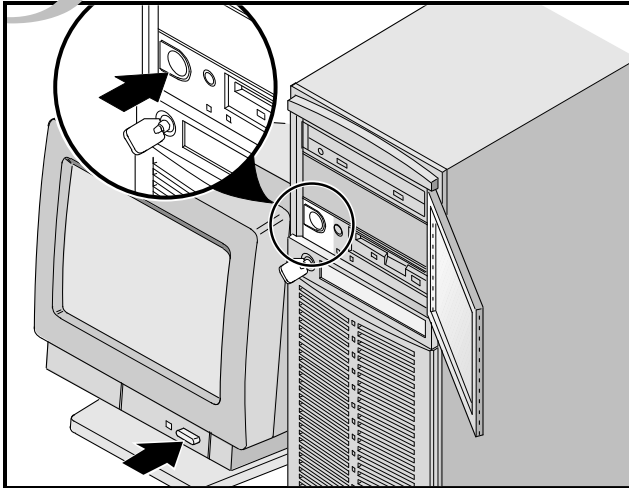

1. Turn on the monitor.
2. Turn on the server.
3. Adjust the monitor contrast and brightness to obtain a readable screen display.

NOTE

Refer to your User's Guide for BIOS and Power-on-self-test (POST) messages.

6 Run the Quick Launch CD-ROM program

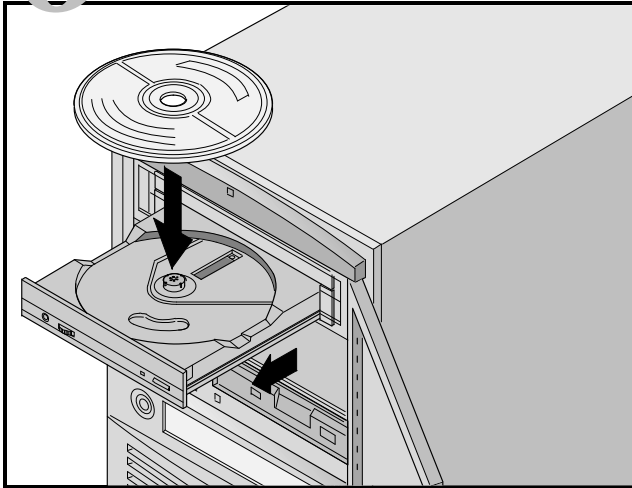

Use the Quick Launch CD-ROM disk to complete the server installation. Follow these steps to configure your server and install an operating system.

NOTE

This procedure assumes that no additional EISA, PCI, or ISA cards have been installed in your server. If you installed optional expansion card(s), you need to perform the instructions on the next page.

1. Locate the Quick Launch CD-ROM disk in your ServerWORKS software kit. Power on your server and insert the CD-ROM disk. Press Ctrl + Alt + Del to reboot your server.
2. When prompted, enter the MS-DOS partition size. Quick Launch then creates an MS-DOS partition on the hard disk drive using the FDISK utility. Afterwards, your server automatically reboots.

The Quick Launch main menu appears and all utilities and related files (SCU, diagnostics, RAID, etc.) are installed onto the MS-DOS partition.

3. Select *Install Software* from the Quick Launch main menu. Choose *Express* for unattended operating system installation of Microsoft Windows NT or Novell NetWare or choose *Conventional* for a traditional operating system installation (SCO UNIX, OS/2, Microsoft Windows NT, or Novell NetWare).

Refer to the Quick Launch Reference Guide included with the ServerWORKS software kit for detailed installation procedures.

If you installed optional expansion cards

Make sure you are familiar with using:

- The System Configuration Utility (SCU)
- The SCSI *Select* Utility

Refer to your User's Guide and SCSI manuals for any additional information.

Use the Quick Launch CD-ROM disk to complete the server installation. Follow these steps to configure your server and install an operating system.

1. Locate the Quick Launch CD-ROM disk in your ServerWORKS software kit. Power on your server and insert the CD-ROM disk. Press Ctrl + Alt + Del to reboot your server.
2. Use the SCU, when displayed, to configure the EISA option cards you installed or to enable the PCI cards. If you installed ISA cards, check the current card configuration to avoid IRQ or address conflicts before manually setting jumpers and switches.

Your server automatically reboots after you save and exit the SCU.
3. When prompted, enter the MS-DOS partition size. Quick Launch then creates an MS-DOS partition on the hard disk drive using the FDISK utility. Afterwards, your server automatically reboots.

The Quick Launch main menu appears and all utilities and related files (SCU, diagnostics, RAID, etc.) are installed onto the MS-DOS partition.

4. Select *Install Software* from the Quick Launch main menu. Choose *Express* for unattended operating system installation of Microsoft Windows NT or Novell NetWare or choose *Conventional* for a traditional operating system installation (SCO UNIX, OS/2, Microsoft Windows NT, or Novell NetWare).

Refer to the Quick Launch Reference Guide included with the ServerWORKS software kit for detailed installation procedures.

NOTE

If you installed additional SCSI cards, make sure the MS-DOS partition resides on the drive you want it to be on. If not, shut down your server, change the order of your cards and reconfigure your server.

8

Express operating system installation

Express Installation Microsoft Windows NT Server & Novell NetWare

You will be asked to provide the following information before you can *Express* install Microsoft Windows NT or Novell NetWare.

Windows NT Server

Full Name _____

Organization Name _____

Server Name _____

Product ID _____

NT Server Type _____

License _____

Time Zone _____

Work Group Name _____

Network

- Install NWLink
- Install NetBEUI
- Install TCPIP

Novell NetWare

Server Name _____

Organization Name _____

Frame Type _____

Administrator Password _____

Time Zone _____

Fill in the information as required. Have your Microsoft Windows NT or Novell Netware software kit ready. Follow the instructions on the screen to begin your operating system installation.

9 *Creating server utility and device driver diskettes*

Use the method described in Step 6 or 7 to boot the Quick Launch CD-ROM disk and configure your server. From the Quick Launch main menu, select *Install Software*. Choose the *Conventional* method to create operating system-specific device driver and server utility diskettes from image files located on the Quick Launch CD-ROM disk. You will need these diskettes to traditionally install Windows NT, Novell NetWare, SCO UNIX, OS/2, and other operating systems.

If you prefer, you can create the required diskettes from Windows 3.1 or Windows for Workgroups based workstations using these procedures:

1. Locate the Quick Launch CD-ROM disk in your ServerWORKS software kit. Insert the CD-ROM disk into the CD-ROM drive.
2. From the Windows Program Manager, select *File*, then *Run*.
3. Enter:
`qlaunch.exe`
4. Select *Install Software* from the ServerWORKS Quick Launch main menu.
5. Select *Conventional* and then your server's operating system. Select your server's model name to view the list of available disk images.

For more information, refer to the ServerWORKS Quick Launch Reference Guide and the on-line help in the ServerWORKS Quick Launch program.

The following is a list of device drivers you might need:

- SCSI—enables your server to operate using an Adaptec SCSI controller.
- Mouse—enables your server to operate using a Logitech mouse.
- Video—enables your server to operate using the onboard Cirrus video controller or other supported video cards.
- Network—choose from several device drivers for Digital supported network interface cards.

The following is a list of bootable server utilities:

- SCU—enables you to make a bootable SCU diskette for use when configuring your server and adding options.
- Diagnostics—enables you to make a bootable diskette for use when troubleshooting your server.
- RAID—enables you to make a bootable RAID Configuration Utility diskette for use when configuring an optional external RAID array.

10

Register your server and review your documentation

Register

1. Record the server's model number and serial number here.

- Server Model Description:

(located on the front of the server)

- Server Model Number and Serial Number:

(located on the back of the server)

2. Send in the registration card contained in your Prioris Server documentation kit.

Warranty

- 3-year on-site hardware warranty.
- Refer to your Warranty and Service Information for specific warranty terms and conditions.

If You Need Help

If you have questions about your sever hardware, software, or warranty, please contact Digital's Customer Service organization.

Before You Call Digital

1. Run the diagnostics shipped with your server to isolate the problem. You can run the diagnostics from the MS-DOS partition created by Quick Launch or you can create a diagnostics diskette from the Quick Launch "Install Software" Conventional button.
2. Have the server's model number and serial number available before you call.
3. Record any error messages and be prepared to describe the sequence of events that led to your problem.
4. Call 1-800-354-9000.

For Technical Information

Technical information is available 24 hours a day on the Digital bulletin board service (BBS). For access call:

US Digital BBS

- 1-508-496-8800

11 *Install the ServerWORKS software*

After your server and network operating system installation is complete, install Digital's ServerWORKS Manager to:

- Access an easy-to-use server management interface
- Monitor critical PC server statistics
- Obtain an easy-to-read topology map of the network
- Manage server fault conditions
- Support distributed SNMP network devices from anywhere on the LAN

NOTE

Refer to the ServerWORKS Manager README FIRST letter and User's Guide in the ServerWORKS software kit for installation information.

ER-792WW-1A



A01



Prioris and ServerWorks are trademarks of Digital Equipment Corporation
SCO UNIX is a trademark of The Santa Cruz Operation, Inc.
OS/2 is a trademark of International Business Machines Corporation
MS-DOS, Windows NT, Windows 3.1 & Windows for Workgroups are registered trademarks of Microsoft Corporation
NetWare is a U.S. registered trademark of Novell, Inc.
Logitech is a trademark of LOGITECH, Inc.
All other trademarks and registered trademarks are the property of their respective holders.
PRINTED IN U.S.A.

