

# HP COBOL

---

## User Manual

Order Number: AA-Q2G1H-TK

**January 2005**

This manual provides information that helps you develop HP COBOL programs for the OpenVMS Alpha, OpenVMS Industry Standard 64, OpenVMS VAX, and Tru64 UNIX platforms.

**Revision/Update Information:** This manual supersedes the *Compaq COBOL User Manual, Version 2.8* and the *VAX COBOL User Manual, Version 5.4*, as well as the online-only *Compaq COBOL User Manual, Version 2.8* and *Version 5.7*.

**Operating System and Version:** OpenVMS I64 Version 8.2  
OpenVMS Alpha Version 6.2 or higher  
OpenVMS VAX Version 6.2 or higher  
Tru64 UNIX Version 5.1 or higher

**Software Version:** HP COBOL for OpenVMS I64  
Version 2.8  
HP COBOL for OpenVMS Alpha  
Version 2.8  
HP COBOL for Tru64 UNIX  
Version 2.8  
HP COBOL for OpenVMS VAX  
Version 5.7A

**Hewlett-Packard Company**  
Palo Alto, California

---

© Copyright 2005 Hewlett-Packard Development Company, L.P.

Confidential computer software. Valid license from HP required for possession, use or copying. Consistent with FAR 12.211 and 12.212, Commercial Computer Software, Computer Software Documentation, and Technical Data for Commercial Items are licensed to the U.S. Government under vendor's standard commercial license.

The information contained herein is subject to change without notice. The only warranties for HP products and services are set forth in the express warranty statements accompanying such products and services. Nothing herein should be construed as constituting an additional warranty. HP shall not be liable for technical or editorial errors or omissions contained herein.

Motif, UNIX and X/Open are trademarks of The Open Group in the U.S. and/or other countries.

All other product names mentioned herein may be trademarks of their respective companies.

Intel and Itanium are trademarks or registered trademarks of Intel Corporation or its subsidiaries in the United States and other countries.

Printed in the US

ZK6297

This manual is available on CD-ROM.

This document was prepared using DECdocument, Version 3.3-1b.

---

# Contents

<b>Preface</b> .....	xxiii
<b>1 Developing HP COBOL Programs</b>	
1.1 Developing Programs on Tru64 UNIX .....	1-1
1.1.1 Creating an HP COBOL Program on Tru64 UNIX .....	1-1
1.1.2 Compiling an HP COBOL Program on Tru64 UNIX .....	1-4
1.1.2.1 Format of the COBOL Command on Tru64 UNIX .....	1-4
1.1.2.2 COBOL Command Flags .....	1-5
1.1.2.3 External File Handler Support .....	1-8
1.1.2.4 Specifying Multiple Files and Flags .....	1-8
1.1.2.5 Compiling Multiple Files .....	1-9
1.1.2.6 Debugging a Program .....	1-9
1.1.2.7 Output Files: Object, Executable, Listing, and Temporary Files .....	1-10
1.1.2.8 Naming Output Files .....	1-10
1.1.2.9 Temporary Files .....	1-10
1.1.2.10 Examples of the COBOL Command .....	1-11
1.1.2.11 Other Compilers .....	1-11
1.1.2.12 Interpreting Messages from the Compiler .....	1-11
1.1.3 Linking an HP COBOL Program on Tru64 UNIX .....	1-12
1.1.3.1 Specifying Object Libraries for Linking .....	1-12
1.1.3.2 Specifying Additional Object Libraries .....	1-13
1.1.3.3 Specifying Types of Object Libraries .....	1-14
1.1.3.4 Creating Shared Object Libraries .....	1-14
1.1.3.5 Shared Library Restrictions .....	1-15
1.1.3.6 Installing Shared Libraries .....	1-15
1.1.3.7 Interpreting Messages from the Linker .....	1-16
1.1.4 Running an HP COBOL Program on Tru64 UNIX .....	1-16
1.1.4.1 Accessing Command-Line Arguments .....	1-16
1.1.4.2 Accessing Environment Variables .....	1-17
1.1.4.3 Errors and Switches .....	1-18
1.1.5 Program Development Stages and Tools .....	1-18
1.2 Developing Programs on OpenVMS .....	1-20
1.2.1 Creating an HP COBOL Program on OpenVMS .....	1-20
1.2.2 Compiling an HP COBOL Program on OpenVMS .....	1-22
1.2.2.1 Format of the COBOL Command on OpenVMS .....	1-22
1.2.2.2 Compiling Multiple Files .....	1-23
1.2.2.3 Debugging a Program .....	1-23
1.2.2.4 Separately Compiled Programs (Alpha, I64) .....	1-24
1.2.2.5 COBOL Qualifiers .....	1-24
1.2.2.6 Common Command-Line Errors to Avoid .....	1-29
1.2.2.7 Compiling Programs with Conditional Compilation .....	1-29
1.2.2.8 Interpreting Messages from the Compiler .....	1-29

1.2.2.9	Using Compiler Listing Files .....	1-31
1.2.3	Linking an HP COBOL Program .....	1-32
1.2.3.1	The LINK Command .....	1-33
1.2.3.2	LINK Qualifiers .....	1-33
1.2.3.3	Specifying Modules Other than HP COBOL Modules .....	1-34
1.2.3.4	Specifying Object Module Libraries .....	1-35
1.2.3.5	Creating Shareable Images .....	1-37
1.2.3.6	Interpreting Messages from the Linker .....	1-42
1.2.4	Running an HP COBOL Program .....	1-43
1.2.4.1	Accessing Command-Line Arguments at Run Time (Alpha, I64) .....	1-43
1.2.4.2	Accessing System Logicals at Run Time (Alpha, I64) .....	1-44
1.2.4.3	Accessing Input and Output Devices at Run Time .....	1-45
1.2.4.4	Debugging Environment .....	1-46
1.2.4.5	Interpreting Run-Time Messages .....	1-46
1.3	HP COBOL and Alpha and I64 Architecture System Resources .....	1-47
1.3.1	Compilation Performance .....	1-47
1.3.2	Tuning OpenVMS Alpha and OpenVMS I64 for Large HP COBOL Compiles .....	1-49
1.3.2.1	Optimizing Virtual Memory Usage .....	1-49
1.3.2.2	Optimizing Physical Memory Usage .....	1-50
1.3.2.3	Improving Compile Performance with Separate Compilation (Alpha, I64) .....	1-51
1.3.3	Choosing a Reference Format .....	1-51
1.3.3.1	Terminal Reference Format .....	1-52
1.3.3.2	Converting Between Reference Formats .....	1-52
1.4	Program Run Messages .....	1-52
1.4.1	Data Errors .....	1-52
1.4.2	Program Logic Errors .....	1-54
1.4.3	Run-Time Input/Output Errors .....	1-55
1.4.4	I/O Errors and RMS (OpenVMS) .....	1-56
1.5	Using Program Switches .....	1-60
1.5.1	Setting and Controlling Switches Internally .....	1-60
1.5.2	Setting and Controlling Switches Externally .....	1-60
1.6	Special Information for Year 2000 Programming .....	1-63

## 2 Handling Numeric Data

2.1	How the Compiler Stores Numeric Data .....	2-1
2.2	Specifying Alignment .....	2-1
2.3	Sign Conventions .....	2-2
2.4	Invalid Values in Numeric Items .....	2-2
2.5	Evaluating Numeric Items .....	2-3
2.5.1	Numeric Relation Test .....	2-3
2.5.2	Numeric Sign Test .....	2-4
2.5.3	Numeric Class Tests .....	2-4
2.5.4	Success/Failure Tests .....	2-5
2.6	Using the MOVE Statement .....	2-6
2.6.1	Elementary Numeric Moves .....	2-6
2.6.2	Elementary Numeric-Edited Moves .....	2-7
2.6.3	Subscripted Moves .....	2-9
2.6.4	Common Move Errors .....	2-9
2.7	Using the Arithmetic Statements .....	2-9
2.7.1	Temporary Work Items .....	2-9

2.7.2	Standard and Native Arithmetic (Alpha, I64) . . . . .	2-10
2.7.2.1	Using the /MATH_INTERMEDIATE Qualifier (Alpha, I64) . . . . .	2-10
2.7.2.2	Using the /ARITHMETIC Qualifier (Alpha, I64) . . . . .	2-12
2.7.3	Specifying a Truncation Qualifier . . . . .	2-13
2.7.4	Using the ROUNDED Phrase . . . . .	2-13
2.7.4.1	ROUNDED with REMAINDER . . . . .	2-13
2.7.5	Using the SIZE ERROR Phrase . . . . .	2-14
2.7.6	Using the GIVING Phrase . . . . .	2-14
2.7.7	Multiple Operands in ADD and SUBTRACT Statements . . . . .	2-15
2.7.8	Common Errors in Arithmetic Statements . . . . .	2-15

### 3 Handling Nonnumeric Data

3.1	How the Compiler Stores Nonnumeric Data . . . . .	3-1
3.2	Data Organization . . . . .	3-2
3.2.1	Group Items . . . . .	3-2
3.2.2	Elementary Items . . . . .	3-2
3.3	Special Characters . . . . .	3-3
3.4	Testing Nonnumeric Items . . . . .	3-3
3.4.1	Relation Tests of Nonnumeric Items . . . . .	3-3
3.4.1.1	Classes of Data . . . . .	3-4
3.4.1.2	Comparison Operations . . . . .	3-5
3.4.2	Class Tests for Nonnumeric Items . . . . .	3-5
3.5	Data Movement . . . . .	3-6
3.6	Using the MOVE Statement . . . . .	3-7
3.6.1	Group Moves . . . . .	3-7
3.6.2	Elementary Moves . . . . .	3-7
3.6.2.1	Edited Moves . . . . .	3-9
3.6.2.2	Justified Moves . . . . .	3-9
3.6.3	Multiple Receiving Items . . . . .	3-10
3.6.4	Subscripted Moves . . . . .	3-10
3.6.5	Common Nonnumeric Item MOVE Statement Errors . . . . .	3-11
3.6.6	Using the MOVE CORRESPONDING Statement for Nonnumeric Items . . . . .	3-11
3.6.7	Using Reference Modification . . . . .	3-12

### 4 Handling Tables

4.1	Defining Tables . . . . .	4-1
4.1.1	Defining Fixed-Length, One-Dimensional Tables . . . . .	4-1
4.1.2	Defining Fixed-Length, Multidimensional Tables . . . . .	4-4
4.1.3	Defining Variable-Length Tables . . . . .	4-5
4.1.4	Storage Allocation for Tables . . . . .	4-6
4.1.4.1	Using the SYNCHRONIZED Clause . . . . .	4-7
4.2	Initializing Values of Table Elements . . . . .	4-10
4.3	Accessing Table Elements . . . . .	4-12
4.3.1	Subscripting . . . . .	4-12
4.3.2	Subscripting with Literals . . . . .	4-13
4.3.3	Subscripting with Data Names . . . . .	4-14
4.3.4	Subscripting with Indexes . . . . .	4-14
4.3.5	Relative Indexing . . . . .	4-15
4.3.6	Index Data Items . . . . .	4-16

4.3.7	Assigning Index Values Using the SET Statement . . . . .	4-16
4.3.7.1	Assigning an Integer Index Value with a SET Statement . . . . .	4-16
4.3.7.2	Incrementing an Index Value with the SET Statement . . . . .	4-16
4.3.8	Identifying Table Elements Using the SEARCH Statement . . . . .	4-16
4.3.8.1	Implementing a Sequential Search . . . . .	4-17
4.3.8.2	Implementing a Binary Search . . . . .	4-18

## 5 Using the STRING, UNSTRING, and INSPECT Statements

5.1	Concatenating Data Using the STRING Statement . . . . .	5-1
5.1.1	Multiple Sending Items . . . . .	5-1
5.1.2	Using the DELIMITED BY Phrase . . . . .	5-2
5.1.3	Using the POINTER Phrase . . . . .	5-4
5.1.4	Using the OVERFLOW Phrase . . . . .	5-4
5.1.5	Common STRING Statement Errors . . . . .	5-6
5.2	Separating Data Using the UNSTRING Statement . . . . .	5-6
5.2.1	Multiple Receiving Items . . . . .	5-6
5.2.2	Controlling Moved Data Using the DELIMITED BY Phrase . . . . .	5-8
5.2.2.1	Multiple Delimiters . . . . .	5-12
5.2.3	Using the COUNT Phrase . . . . .	5-12
5.2.4	Saving UNSTRING Delimiters Using the DELIMITER Phrase . . . . .	5-13
5.2.5	Controlling UNSTRING Scanning Using the POINTER Phrase . . . . .	5-14
5.2.6	Counting UNSTRING Receiving Items Using the TALLYING Phrase . . . . .	5-15
5.2.7	Exiting an UNSTRING Statement Using the OVERFLOW Phrase . . . . .	5-16
5.2.8	Common UNSTRING Statement Errors . . . . .	5-16
5.3	Examining and Replacing Characters Using the INSPECT Statement . . . . .	5-17
5.3.1	Using the TALLYING and REPLACING Options of the INSPECT Statement . . . . .	5-17
5.3.2	Restricting Data Inspection Using the BEFORE/AFTER Phrase . . . . .	5-18
5.3.3	Implicit Redefinition . . . . .	5-18
5.3.4	Examining the INSPECT Operation . . . . .	5-21
5.3.4.1	Setting the Scanner . . . . .	5-22
5.3.4.2	Active/Inactive Arguments . . . . .	5-22
5.3.4.3	Finding an Argument Match . . . . .	5-23
5.3.5	The TALLYING Phrase . . . . .	5-24
5.3.5.1	The Tally Counter . . . . .	5-24
5.3.5.2	The Tally Argument . . . . .	5-24
5.3.5.3	The Tally Argument List . . . . .	5-25
5.3.5.4	Interference in Tally Argument Lists . . . . .	5-27
5.3.6	Using the REPLACING Phrase . . . . .	5-30
5.3.6.1	The Search Argument . . . . .	5-30
5.3.6.2	The Replacement Value . . . . .	5-31
5.3.6.3	The Replacement Argument . . . . .	5-31
5.3.6.4	The Replacement Argument List . . . . .	5-31
5.3.6.5	Interference in Replacement Argument Lists . . . . .	5-32
5.3.7	Using the CONVERTING Option . . . . .	5-33
5.3.8	Common INSPECT Statement Errors . . . . .	5-33

## 6 Processing Files and Records

6.1	Defining Files and Records .....	6-1
6.1.1	File Organization .....	6-2
6.1.2	Record Format .....	6-8
6.1.3	Print-Control Records .....	6-12
6.1.4	File Design .....	6-13
6.2	Identifying Files and Records from Within Your HP COBOL Program ...	6-14
6.2.1	Defining a File Connector .....	6-14
6.2.2	Specifying File Organization and Record Access Mode .....	6-20
6.3	Creating and Processing Files .....	6-25
6.3.1	Opening and Closing Files .....	6-25
6.3.2	File Handling for Sequential and Line Sequential (Alpha, I64) Files .....	6-26
6.3.3	File Handling for Relative Files .....	6-29
6.3.4	File Handling for Indexed Files .....	6-32
6.4	Reading Files .....	6-37
6.4.1	Reading a Sequential or Line Sequential (Alpha, I64) File .....	6-37
6.4.2	Reading a Relative File .....	6-38
6.4.3	Reading an Indexed File .....	6-41
6.5	Updating Files .....	6-49
6.5.1	Updating a Sequential File or Line Sequential (Alpha, I64) File .....	6-49
6.5.2	Updating a Relative File .....	6-51
6.5.2.1	Rewriting a Relative File .....	6-51
6.5.2.2	Deleting Records from a Relative File .....	6-54
6.5.3	Updating an Indexed File .....	6-56
6.6	Backing Up Your Files .....	6-61

## 7 Handling Input/Output Exception Conditions

7.1	Planning for the AT END Condition .....	7-1
7.2	Planning for the Invalid Key Condition .....	7-2
7.3	Using File Status Values and OpenVMS RMS Completion Codes .....	7-3
7.3.1	File Status Values .....	7-3
7.3.2	RMS Completion Codes (OpenVMS) .....	7-5
7.4	Using Declarative USE Procedures .....	7-8

## 8 Sharing Files and Locking Records

8.1	Controlling Access to Files and Records .....	8-1
8.2	Choosing a File Sharing and Record Locking Standard (Alpha, I64) .....	8-3
8.3	Ensuring Successful File Sharing .....	8-4
8.3.1	Providing Disk Residency .....	8-4
8.3.2	Using File Protection .....	8-4
8.3.3	Determining the Intended Access Mode to a File .....	8-6
8.3.4	Specifying File Access Using X/Open Standard File Sharing (Alpha, I64) .....	8-6
8.3.5	Specifying File Access Using Hewlett-Packard Standard File Sharing .....	8-8
8.3.6	Error Handling for File Sharing .....	8-12
8.4	Ensuring Successful Record Locking .....	8-17
8.4.1	X/Open Standard Record Locking (Alpha, I64) .....	8-17
8.4.2	Hewlett-Packard Standard Record Locking .....	8-19
8.4.3	Error Handling for Record Locking .....	8-23

## 9 Using the SORT and MERGE Statements

9.1	Sorting Data with the SORT Statement	9-1
9.1.1	File Organization Considerations for Sorting	9-2
9.1.2	Specifying Sort Parameters with the ASCENDING and DESCENDING KEY Phrases	9-3
9.1.3	Resequencing Files with the USING and GIVING Phrases	9-3
9.1.4	Manipulating Data Before and After Sorting with the INPUT PROCEDURE and OUTPUT PROCEDURE Phrases	9-3
9.1.5	Maintaining the Input Order of Records Using the WITH DUPLICATES IN ORDER Phrase	9-6
9.1.6	Specifying Non-ASCII Collating Sequences with the COLLATING SEQUENCE IS Alphabet-Name Phrase	9-7
9.1.7	Multiple Sorting	9-7
9.1.8	Sorting Variable-Length Records	9-8
9.1.9	Preventing I/O Aborts	9-9
9.1.10	Sorting Tables (Alpha, I64)	9-9
9.1.11	Sorting at the Operating System Level	9-9
9.2	Merging Data with the MERGE Statement	9-10
9.3	Sample Programs Using the SORT and MERGE Statements	9-10

## 10 Producing Printed Reports

10.1	Designing a Report	10-1
10.2	Components of a Report	10-1
10.3	Accumulating and Reporting Totals	10-4
10.4	The Logical Page and the Physical Page	10-5
10.5	Programming a Conventional File Report	10-6
10.5.1	Defining the Logical Page in a Conventional Report	10-6
10.5.2	Controlling the Spacing in a Conventional Report	10-7
10.5.3	Advancing to the Next Logical Page in a Conventional Report	10-7
10.5.3.1	Programming for the Page-Overflow Condition in a Conventional Report	10-7
10.5.3.2	Using a Line Counter	10-8
10.5.4	Printing the Conventional Report	10-9
10.5.5	A Conventional File Report Example	10-9
10.6	Programming a Linage-File HP COBOL Report	10-12
10.6.1	Defining the Logical Page in a Linage-File Report	10-13
10.6.2	Controlling the Spacing in a Linage-File Report	10-14
10.6.3	Using the LINAGE-COUNTER	10-14
10.6.4	Advancing to the Next Logical Page in a Linage-File Report	10-14
10.6.5	Programming for the End-of-Page and Page-Overflow Condition	10-15
10.6.6	Printing a Linage-File Report	10-19
10.6.7	A Linage-File Report Example	10-20
10.7	Modes for Printing Reports	10-23
10.7.1	Spooling to a Mass Storage Device	10-23
10.8	Programming a Report Writer Report	10-24
10.8.1	Using the REPORT Clause in the File Section	10-24
10.8.2	Defining the Report Section and the Report File	10-24
10.8.3	Defining a Report Writer Logical Page with the PAGE Clause	10-25
10.8.4	Describing Report Group Description Entries	10-25
10.8.5	Vertical Spacing for the Logical Page	10-28
10.8.6	Horizontal Spacing for the Logical Page	10-29
10.8.7	Assigning a Value in a Print Line	10-30
10.8.8	Defining the Source for a Print Field	10-30



10.8.9	Specifying Multiple Reports . . . . .	10-31
10.8.10	Generating and Controlling Report Headings and Footings . . . . .	10-31
10.8.11	Defining and Incrementing Totals . . . . .	10-33
10.8.11.1	Subtotaling . . . . .	10-33
10.8.11.2	Crossfooting . . . . .	10-34
10.8.11.3	Rolling Forward . . . . .	10-34
10.8.11.4	RESET Option . . . . .	10-35
10.8.11.5	UPON Option . . . . .	10-35
10.8.12	Restricting Print Items . . . . .	10-36
10.8.13	Processing a Report Writer Report . . . . .	10-37
10.8.13.1	Initiating the Report . . . . .	10-37
10.8.13.2	Generating a Report Writer Report . . . . .	10-38
10.8.13.3	Automatic Operations of the GENERATE Statement . . . . .	10-38
10.8.13.4	Ending Report Writer Processing . . . . .	10-39
10.8.13.5	Applying the USE BEFORE REPORTING Statement . . . . .	10-40
10.8.13.6	Suppressing a Report Group . . . . .	10-41
10.8.14	Selecting a Report Writer Report Type . . . . .	10-41
10.8.14.1	Detail Reporting . . . . .	10-41
10.8.14.2	Summary Reporting . . . . .	10-42
10.9	Report Writer Examples . . . . .	10-42
10.9.1	Input Data . . . . .	10-42
10.9.2	EX1006—Detail Report Program . . . . .	10-43
10.9.3	EX1007—Detail Report Program . . . . .	10-48
10.9.4	EX1008—Detail Report Program . . . . .	10-56
10.9.5	EX1009—Detail Report Program . . . . .	10-64
10.9.6	EX1010—Summary Report Program . . . . .	10-73
10.10	Solving Report Problems . . . . .	10-82
10.10.1	Printing More Than One Logical Line on a Single Physical Line . . . . .	10-82
10.10.2	Group Indicating . . . . .	10-87
10.10.3	Fitting Reports on the Page . . . . .	10-88
10.10.4	Printing Totals Before Detail Lines . . . . .	10-88
10.10.5	Underlining Items in Your Reports . . . . .	10-89
10.10.6	Bolding Items in Your Reports . . . . .	10-89

## 11 Using ACCEPT and DISPLAY Statements for Input/Output and Video Forms

11.1	Using ACCEPT and DISPLAY for I/O . . . . .	11-1
11.2	Designing Video Forms with ACCEPT and DISPLAY Statement Extensions . . . . .	11-3
11.2.1	Clearing a Screen Area . . . . .	11-4
11.2.2	Horizontal and Vertical Positioning of the Cursor . . . . .	11-5
11.2.3	Assigning Character Attributes to Your Format Entries . . . . .	11-8
11.2.4	Using the CONVERSION Phrase to Display Numeric Data . . . . .	11-9
11.2.5	Handling Data with ACCEPT Options . . . . .	11-12
11.2.5.1	Using CONVERSION with ACCEPT Data . . . . .	11-13
11.2.5.2	Using ON EXCEPTION When Accepting Data with CONVERSION . . . . .	11-13
11.2.5.3	Protecting the Screen . . . . .	11-13
11.2.5.4	Using NO ECHO with ACCEPT Data . . . . .	11-15
11.2.5.5	Assigning Default Values to Data Fields . . . . .	11-17
11.2.6	Using Terminal Keys to Define Special Program Functions . . . . .	11-20
11.2.7	Using the EDITING Phrase . . . . .	11-28

11.3	Designing Video Forms with Screen Section ACCEPT and DISPLAY (Alpha, I64) . . . . .	11-31
11.3.1	Using Screen Section Options (Alpha, I64) . . . . .	11-32
11.3.1.1	Comparison of Screen Section Extensions (Alpha, I64) with Other Extensions of ACCEPT and DISPLAY . . . . .	11-34

## 12 Interprogram Communication

12.1	Multiple COBOL Program Run Units . . . . .	12-1
12.1.1	Examples of COBOL Run Units . . . . .	12-1
12.1.2	Calling Procedures . . . . .	12-2
12.2	COBOL Program Attributes . . . . .	12-3
12.2.1	The INITIAL Clause . . . . .	12-4
12.2.2	The EXTERNAL Clause . . . . .	12-5
12.3	Transferring Flow of Control . . . . .	12-5
12.3.1	The CALL Statement . . . . .	12-5
12.3.2	Nesting CALL Statements . . . . .	12-6
12.3.3	The EXIT PROGRAM Statement . . . . .	12-8
12.3.4	CALL Literal Versus CALL Data Name . . . . .	12-9
12.4	Accessing Another Program's Data Division . . . . .	12-10
12.4.1	The USING Phrase . . . . .	12-11
12.4.2	The Linkage Section . . . . .	12-13
12.5	Communicating with Contained COBOL Programs . . . . .	12-14
12.5.1	The COMMON Clause . . . . .	12-15
12.5.2	The GLOBAL Clause . . . . .	12-16
12.5.2.1	Sharing GLOBAL Data . . . . .	12-16
12.5.2.2	Sharing GLOBAL Files . . . . .	12-16
12.5.2.3	Sharing USE Procedures . . . . .	12-17
12.5.2.4	Sharing Other Resources . . . . .	12-19
12.6	Calling HP COBOL Programs from Other Languages (Alpha, I64) . . . . .	12-20
12.6.1	Calling COBOL Programs from C (Alpha, I64) . . . . .	12-20
12.7	Calling Non-COBOL Programs from HP COBOL . . . . .	12-26
12.7.1	Calling a Fortran Program . . . . .	12-27
12.7.2	Calling a BASIC Program . . . . .	12-28
12.7.3	Calling a C Program . . . . .	12-30
12.8	Special Considerations for Interprogram Communication . . . . .	12-31
12.8.1	CALL and CANCEL Arguments . . . . .	12-31
12.8.2	Calling OpenVMS Alpha and I64 Shareable Images (OpenVMS) . . . . .	12-32
12.8.3	Calling Tru64 UNIX Shareable Objects (Tru64 UNIX) . . . . .	12-32
12.8.4	Case Sensitivity on Tru64 UNIX . . . . .	12-32
12.8.4.1	Linker Case Sensitivity . . . . .	12-32
12.8.4.2	Calling C Programs from HP COBOL on Tru64 UNIX . . . . .	12-33
12.8.4.3	Calling COBOL Programs from C on Tru64 UNIX . . . . .	12-33
12.8.5	Additional Information . . . . .	12-34

## 13 Using HP COBOL in the Alpha, I64, or VAX Common Language Environment

13.1	Routines, Procedures, and Functions . . . . .	13-1
13.2	The OpenVMS Calling Standard (OpenVMS) . . . . .	13-2
13.2.1	Register and Stack Usage (Alpha, I64) . . . . .	13-2
13.2.2	Return of the Function Value . . . . .	13-3
13.2.3	The Argument List . . . . .	13-3
13.3	OpenVMS System Routines (OpenVMS) . . . . .	13-3

13.3.1	OpenVMS Run-Time Library Routines	13-4
13.3.2	System Services	13-4
13.4	Calling Routines	13-5
13.4.1	Determining the Type of Call (OpenVMS)	13-5
13.4.2	Defining the Argument (OpenVMS)	13-6
13.4.3	Calling the External Routine (OpenVMS)	13-7
13.4.4	Calling System Routines (OpenVMS)	13-8
13.4.4.1	System Routine Arguments (OpenVMS)	13-8
13.4.4.2	Calling a System Routine in a Function Call (OpenVMS)	13-11
13.4.4.3	Calling a System Routine in a Procedure Call (OpenVMS)	13-13
13.4.5	Checking the Condition Value (OpenVMS)	13-13
13.4.5.1	Library Return Status and Condition Value Symbols (OpenVMS)	13-15
13.4.6	Locating the Result (OpenVMS)	13-15
13.5	Establishing and Removing User Condition Handlers (OpenVMS)	13-15
13.6	Examples (OpenVMS)	13-19

## 14 Using the REFORMAT Utility

14.1	Running the REFORMAT Utility	14-1
14.2	ANSI-to-Terminal Format Conversion	14-2
14.3	Terminal-to-ANSI Format Conversion	14-3
14.4	REFORMAT Error Messages	14-4

## 15 Optimizing Your HP COBOL Program

15.1	Specifying Optimization on the Compiler Command Line (Alpha, I64)	15-1
15.2	Specifying Alignment of Data for Optimum Performance (Alpha, I64)	15-5
15.3	Using COMP Data Items for Speed	15-6
15.4	Other Ways to Improve the Performance of Operations on Numeric Data	15-7
15.4.1	Mixing Scale Factors and Data Types	15-7
15.4.2	Limiting Significant Digits	15-8
15.4.3	Reducing the Complexity of Arithmetic Expressions	15-8
15.4.4	Selection of Data Types (OpenVMS)	15-8
15.5	Choices in Procedure Division Statements	15-9
15.5.1	Using Indexing Instead of Subscripting	15-9
15.5.2	Using SEARCH ALL Instead of SEARCH	15-9
15.5.3	Selecting Hypersort or SORT-32 for Sorting Tasks	15-10
15.5.4	Minimizing USE Procedures with LINKAGE SECTION References	15-10
15.6	I/O Operations	15-10
15.6.1	Using the APPLY Clause	15-11
15.6.1.1	Using the PREALLOCATION Phrase of the APPLY Clause (OpenVMS)	15-11
15.6.1.2	Using the EXTENSION Phrase of the APPLY Clause (OpenVMS)	15-12
15.6.1.3	Using the DEFERRED-WRITE Phrase of the APPLY Clause (OpenVMS)	15-12
15.6.1.4	Using the FILL-SIZE ON Phrase of the APPLY Clause (OpenVMS)	15-12
15.6.1.5	Using the WINDOW Phrase of the APPLY Clause (OpenVMS)	15-13
15.6.2	Using Multiple Buffers	15-13
15.6.3	Sharing Record Areas	15-13

15.6.4	Using COMP Unsigned Longword Integers . . . . .	15-15
15.7	Optimizing File Design (OpenVMS) . . . . .	15-15
15.7.1	Sequential Files . . . . .	15-15
15.7.2	Relative Files . . . . .	15-16
15.7.2.1	Maximum Record Number (MRN) . . . . .	15-16
15.7.2.2	Cell Size . . . . .	15-16
15.7.2.3	Bucket Size . . . . .	15-17
15.7.2.4	File Size . . . . .	15-18
15.7.3	Indexed Files . . . . .	15-19
15.7.3.1	Optimizing Indexed File I/O . . . . .	15-20
15.7.3.2	Calculating Key Index Levels . . . . .	15-24
15.7.3.3	Caching Index Roots . . . . .	15-25
15.8	Image Activation Optimization (Tru64 UNIX) . . . . .	15-25

## 16 Managing Memory and Data Access

16.1	Managing Memory Granularity (Alpha, I64) . . . . .	16-1
16.2	Using the VOLATILE Compiler Directive (Alpha, I64) . . . . .	16-3
16.3	Aligning Data for Performance and Compatibility (Alpha, I64) . . . . .	16-3
16.3.1	Data Boundaries (Alpha, I64) . . . . .	16-4
16.3.2	Data Field Padding (Alpha, I64) . . . . .	16-4
16.3.3	Alignment Directives, Qualifiers, and Flags (Alpha, I64) . . . . .	16-4
16.3.4	Specifying Alignment at Compile Time (Alpha, I64) . . . . .	16-5
16.4	Using Alignment Directives, Qualifiers, and Flags (Alpha, I64) . . . . .	16-6
16.4.1	Order of Alignment Operations (Alpha, I64) . . . . .	16-6
16.4.2	Nesting Alignment Directives (Alpha, I64) . . . . .	16-7
16.4.2.1	SYNCHRONIZED Clause . . . . .	16-8
16.4.3	Comparing Alignment Directive Effects . . . . .	16-9

## A Compiler Implementation Specifications

### B HP COBOL on Four Platforms: Compatibility and Migration

B.1	Compatibility Matrix . . . . .	B-1
B.2	Differences in Extensions and Other Features . . . . .	B-3
B.3	Command-Line Qualifiers (Options or Flags) . . . . .	B-4
B.3.1	Qualifiers and Flags Shared by HP COBOL on Alpha, I64, and VAX . . . . .	B-4
B.3.2	Alpha- and I64-Specific COBOL Qualifiers and Flags . . . . .	B-6
B.3.3	Qualifiers Only on HP COBOL for OpenVMS VAX . . . . .	B-7
B.4	HP COBOL Behavior Differences on VAX and Alpha and I64 . . . . .	B-9
B.4.1	Program Structure Messages . . . . .	B-9
B.4.2	Program Listing Differences . . . . .	B-10
B.4.2.1	Machine Code . . . . .	B-10
B.4.2.2	Module Names . . . . .	B-10
B.4.2.3	COPY and REPLACE Statements . . . . .	B-10
B.4.2.4	Multiple COPY Statements . . . . .	B-11
B.4.2.5	COPY Insert Statement . . . . .	B-12
B.4.2.6	REPLACE and COPY REPLACING Statements . . . . .	B-13
B.4.2.7	DATE COMPILED Statement . . . . .	B-14
B.4.2.8	Compiler Listings and Separate Compilations (OpenVMS) . . . . .	B-14
B.4.3	Output Formatting . . . . .	B-15

B.4.4	HP COBOL Statement Differences on Alpha, I64, and VAX	B-15
B.4.4.1	ACCEPT and DISPLAY Statements	B-15
B.4.4.2	LINAGE Clause	B-16
B.4.4.3	MOVE Statement	B-16
B.4.4.4	SEARCH Statement	B-17
B.4.5	System Return Codes	B-17
B.4.6	Diagnostic Messages	B-19
B.4.7	Storage for Double-Precision Data Items	B-20
B.4.8	File Status Values	B-21
B.4.9	RMS Special Registers (OpenVMS)	B-21
B.4.10	Calling Shareable Images	B-22
B.4.11	Sharing Common Blocks (OpenVMS)	B-22
B.4.12	Arithmetic Operations	B-22
B.5	Differences Between Releases and Across Operating Systems	B-24
B.5.1	REWRITE	B-24
B.5.2	File Sharing and Record Locking	B-24
B.5.3	VFC File Format	B-25
B.5.4	File Attribute Checking (Tru64 UNIX)	B-25
B.5.5	Indexed Files	B-26
B.5.6	RMS Special Register References in Your Code	B-26
B.6	File Compatibility Across Languages and Platforms	B-26
B.7	LIB\$INITIALIZE Interaction Between C and COBOL	B-27
B.8	Reserved Words	B-28
B.9	Debugger Support Differences	B-28
B.10	DECset/LSE Support Differences	B-28
B.11	DBMS Support	B-28
B.11.1	Compiling on Tru64 UNIX	B-28
B.11.2	Multistream DBMS DML	B-29

## C Programming Productivity Tools

C.1	Debugging Tools for HP COBOL Programs	C-1
C.2	Ladebug Debugger (Tru64 UNIX)	C-3
C.3	OpenVMS Debugger (OpenVMS)	C-6
C.3.1	Notes on HP COBOL Support	C-6
C.3.2	Notes on Debugging Optimized Programs (Alpha, I64)	C-7
C.3.3	Sample Debugging Session (Alpha, I64)	C-7
C.3.3.1	Separately Compiled Programs	C-11
C.4	Language-Sensitive Editor and the Source Code Analyzer (OpenVMS)	C-12
C.4.1	Notes on HP COBOL Support	C-12
C.4.2	Preparing an SCA Library	C-13
C.4.3	Starting and Terminating an LSE or an SCA Session	C-13
C.4.4	Compiling from Within LSE	C-14
C.5	Using Oracle CDD/Repository (OpenVMS)	C-15
C.5.1	Creating Record and Field Definitions	C-15
C.5.2	Accessing Oracle CDD/Repository Definitions from HP COBOL Programs	C-16
C.5.3	Recording Dependencies	C-17
C.5.4	Data Types	C-19
C.5.5	For More Information	C-21

## D Porting to HP COBOL from Other Compilers (Alpha, I64)

D.1	Porting Assistance . . . . .	D-1
D.2	Flagged Foreign Extensions . . . . .	D-3
D.3	Implemented Extensions . . . . .	D-3

## Index

## Examples

1-1	Accessing Environment Variables and Command-Line Arguments . . .	1-17
1-2	Main Program and Subprograms . . . . .	1-38
1-3	Command Procedure to Compile and Link Subprograms as Shareable Images (Alpha, I64) . . . . .	1-38
1-4	Command Procedure to Compile, Link, and Install Subprograms as Shareable Images (VAX) . . . . .	1-40
1-5	Transfer Vectors (VAX) . . . . .	1-41
1-6	Accessing Logicals and Command-Line Arguments (Alpha, I64) . . . . .	1-44
1-7	Using RMS Special Registers to Detect Errors (OpenVMS) . . . . .	1-56
1-8	Using RMS-CURRENT Special Registers to Detect Errors (OpenVMS) . . . . .	1-59
2-1	Success/Failure Test . . . . .	2-5
3-1	Item Concatenation Using Two MOVE Statements . . . . .	3-6
3-2	Sample Record Description Using the MOVE CORRESPONDING Statement . . . . .	3-11
4-1	One-Dimensional Table . . . . .	4-2
4-2	Multiple Data Items in a One-Dimensional Table . . . . .	4-2
4-3	Defining a Table with an Index and an Ascending Search Key . . . . .	4-3
4-4	Defining a Two-Dimensional Table . . . . .	4-4
4-5	Defining a Three-Dimensional Table . . . . .	4-5
4-6	Defining a Variable-Length Table . . . . .	4-6
4-7	Sample Record Description Defining a Table . . . . .	4-7
4-8	Record Description Containing a COMP SYNC Item . . . . .	4-8
4-9	Adding an Item Without Changing the Table Size . . . . .	4-8
4-10	How Adding 3 Bytes Adds 4 Bytes to the Element Length . . . . .	4-9
4-11	Initializing Tables with the VALUE Clause . . . . .	4-10
4-12	Initializing a Table with the OCCURS Clause . . . . .	4-10
4-13	Initializing Mixed Usage Items . . . . .	4-11
4-14	Initializing Alphanumeric Items . . . . .	4-12
4-15	Using a Literal Subscript to Access a Table . . . . .	4-13
4-16	Subscripting a Multidimensional Table . . . . .	4-13
4-17	Subscripting with Index Name Items . . . . .	4-15
4-18	Sample Table . . . . .	4-19
4-19	A Serial Search . . . . .	4-20
4-20	Using SEARCH and Varying an Index Other than the First Index . . .	4-21
4-21	Using SEARCH and Varying an Index Data Item . . . . .	4-21
4-22	Using SEARCH and Varying an Index not Associated with the Target Table . . . . .	4-22

4-23	Doing a Serial Search Without Using the VARYING Phrase . . . . .	4-22
4-24	A Multiple-Key, Binary Search . . . . .	4-23
5-1	Using the STRING Statement and Literals . . . . .	5-2
5-2	Sample Overflow Condition . . . . .	5-5
6-1	Sample Record Description . . . . .	6-9
6-2	Determining Fixed-Length Record Size . . . . .	6-9
6-3	Determining Fixed-Length Record Size for Files with Multiple Record Descriptions . . . . .	6-10
6-4	Creating Variable-Length Records with the DEPENDING ON Phrase . . . . .	6-10
6-5	Creating Variable-Length Records with the RECORD VARYING Phrase . . . . .	6-11
6-6	Creating Variable-Length Records and Using the OCCURS Clause with the DEPENDING ON Phrase . . . . .	6-11
6-7	Defining Fixed-Length Records with Multiple Record Descriptions . . .	6-12
6-8	Defining a Disk File . . . . .	6-15
6-9	Defining a Magnetic Tape File (OpenVMS) . . . . .	6-16
6-10	Defining a Magnetic Tape File (Tru64 UNIX) . . . . .	6-16
6-11	Using Environment Variables (Tru64 UNIX) or Logical Names (OpenVMS) for File Specification . . . . .	6-19
6-12	Using Environment Variables . . . . .	6-20
6-13	Specifying Sequential File Organization and Sequential Access Mode for a Sequential File . . . . .	6-21
6-14	Specifying Relative File Organization and Random Access Mode for a Relative File . . . . .	6-22
6-15	Specifying Indexed File Organization and Dynamic Access Mode for an Indexed File . . . . .	6-22
6-16	Specifying Line Sequential File Organization with Sequential Access Mode (Alpha, I64) . . . . .	6-23
6-17	SELECT Statements for Sequential Files with Sequential Access Mode . . . . .	6-24
6-18	SELECT Statements for Relative Files with Sequential and Dynamic Access Modes . . . . .	6-24
6-19	SELECT Statements for Indexed Files with Dynamic and Default Sequential Access Modes . . . . .	6-24
6-20	SELECT Statements for Line Sequential Files with Sequential Access Modes (Alpha, I64) . . . . .	6-24
6-21	OPEN and CLOSE Statements . . . . .	6-25
6-22	Creating a Sequential File . . . . .	6-26
6-23	Creating a Line Sequential File (Alpha, I64) . . . . .	6-27
6-24	Creating a Relative File in Sequential Access Mode . . . . .	6-30
6-25	Creating a Relative File in Random Access Mode . . . . .	6-31
6-26	Creating and Populating an Indexed File . . . . .	6-33
6-27	Using Segmented Keys . . . . .	6-35
6-28	Reading a Sequential File . . . . .	6-38
6-29	Reading a Relative File Sequentially . . . . .	6-39
6-30	Reading a Relative File Randomly . . . . .	6-40
6-31	Reading a Relative File Dynamically . . . . .	6-41
6-32	Reading an Indexed File Sequentially . . . . .	6-42

6-33	Reading an Indexed File Randomly . . . . .	6-43
6-34	Reading an Indexed File Dynamically . . . . .	6-44
6-35	Reading an Indexed File Dynamically, with READ PRIOR (Alpha, I64) . . . . .	6-45
6-36	Another Example of READ PRIOR (Alpha, I64) . . . . .	6-47
6-37	Rewriting a Sequential File . . . . .	6-50
6-38	Extending a Sequential File or Line Sequential File (Alpha, I64) . . . .	6-51
6-39	Rewriting Relative Records in Sequential Access Mode . . . . .	6-52
6-40	Rewriting Relative Records in Random Access Mode . . . . .	6-53
6-41	Deleting Relative Records in Sequential Access Mode . . . . .	6-55
6-42	Deleting Relative Records in Random Access Mode . . . . .	6-56
6-43	Updating an Indexed File Sequentially . . . . .	6-57
6-44	Updating an Indexed File Randomly . . . . .	6-59
7-1	Handling the AT END Condition . . . . .	7-2
7-2	Handling the Invalid Key Condition . . . . .	7-3
7-3	Defining a File Status for a File . . . . .	7-4
7-4	Using the File Status Value in an Exception Handling Routine . . . . .	7-5
7-5	Referencing RMS-STS, RMS-STV, RMS-CURRENT-STS, and RMS-CURRENT-STV Codes (OpenVMS) . . . . .	7-6
7-6	The Declaratives Skeleton . . . . .	7-9
7-7	A Declarative USE Procedure Skeleton . . . . .	7-9
7-8	Five Types of Declarative USE Procedures . . . . .	7-10
8-1	X/Open Standard Lock Modes and Opening Files (Alpha, I64) . . . . .	8-7
8-2	Program Segment for File Status Values . . . . .	8-13
8-3	Program Segment for RMS-STS Values (OpenVMS) . . . . .	8-15
8-4	X/Open Standard Record Locking (Alpha, I64) . . . . .	8-18
8-5	Automatic Record Locking (HP Standard) . . . . .	8-19
8-6	Sample Program Using Manual Record Locking (HP Standard) . . . . .	8-21
8-7	Program Segment for Record-Locking Exceptions . . . . .	8-25
9-1	INPUT and OUTPUT PROCEDURE Phrases . . . . .	9-4
9-2	USING Phrase Replaces INPUT PROCEDURE Phrase . . . . .	9-6
9-3	Overriding the COLLATING SEQUENCE IS Phrase . . . . .	9-7
9-4	Using Two Sort Files . . . . .	9-7
9-5	The Declarative USE AFTER STANDARD ERROR PROCEDURE . . . . .	9-9
9-6	Using the MERGE Statement . . . . .	9-10
9-7	Sorting a File with the USING and GIVING Phrases . . . . .	9-11
9-8	Using the USING and OUTPUT PROCEDURE Phrases . . . . .	9-12
9-9	Using the INPUT PROCEDURE and OUTPUT PROCEDURE Phrases . . . . .	9-14
9-10	Using the COLLATING SEQUENCE IS Phrase . . . . .	9-16
9-11	Creating a New Sort Key . . . . .	9-17
9-12	Merging Files . . . . .	9-19
10-1	Components of a Report . . . . .	10-2
10-2	Checking for the Page-Overflow Condition . . . . .	10-8
10-3	Page Advancing and Line Skipping . . . . .	10-9
10-4	Checking for End-of-Page on a 28-Line Logical Page . . . . .	10-16



10-5	Programming a 20-Line Logical Page Defined by the LINAGE Clause with Automatic Page Overflow . . . . .	10-22
10-6	Sample Program EX1006 . . . . .	10-44
10-7	Sample Program EX1007 . . . . .	10-48
10-8	Sample Program EX1008 . . . . .	10-57
10-9	Sample Program EX1009 . . . . .	10-64
10-10	Sample Program EX1010 . . . . .	10-74
10-11	Printing Labels Four-Up . . . . .	10-83
10-12	Printing Labels Four-Up in Sort Order . . . . .	10-85
11-1	Erasing a Screen . . . . .	11-5
11-2	Cursor Positioning . . . . .	11-6
11-3	Using PLUS for Cursor Positioning . . . . .	11-8
11-4	Using Character Attributes . . . . .	11-9
11-5	Using the CONVERSION Phrase . . . . .	11-10
11-6	Using the ON EXCEPTION Phrase . . . . .	11-14
11-7	Using the SIZE and PROTECTED Phrases . . . . .	11-16
11-8	Using the NO ECHO Phrase . . . . .	11-17
11-9	Using the DEFAULT Phrase . . . . .	11-18
11-10	Using the CONTROL KEY IN Phrase . . . . .	11-25
11-11	EDITING Phrase Sample Code . . . . .	11-29
11-12	Designing a Video Form for a Daily Calendar (Alpha, I64) . . . . .	11-36
12-1	Run Unit with Three Separately Compiled Programs . . . . .	12-2
12-2	Run Unit with a Main Program and Two Contained Programs . . . . .	12-3
12-3	Run Unit with Three Separately Compiled Programs, One with Two Contained Programs . . . . .	12-4
12-4	Execution Sequence of Nested CALL Statements . . . . .	12-6
12-5	Sequence of Messages Displayed When Example 12-4 Is Run . . . . .	12-8
12-6	CALL Literal Versus CALL Data Name . . . . .	12-9
12-7	Using the COMMON Clause . . . . .	12-15
12-8	Calling a COBOL Program from C (Alpha, I64) . . . . .	12-21
12-9	C Include File cobfunc.h (Alpha, I64) . . . . .	12-21
12-10	COBOL Called Program "CALLEDFROMC" (Alpha, I64) . . . . .	12-22
12-11	C Program Using cobcall, cobfunc, and cobcancel (Alpha, I64) . . . . .	12-23
12-12	COBOL Called Program "PROGCOB" (Alpha, I64) . . . . .	12-24
12-13	Calling a Fortran Program from a COBOL Program . . . . .	12-27
12-14	Fortran Subroutine SQROOT . . . . .	12-28
12-15	Calling a BASIC Program from a COBOL Program . . . . .	12-29
12-16	BASIC Program "APP" and Output Data . . . . .	12-30
12-17	C Routine to Be Called from a COBOL Program . . . . .	12-30
12-18	Calling a C Program from a COBOL Program . . . . .	12-31
13-1	User-Written Condition Handler . . . . .	13-17
13-2	Random Number Generator (OpenVMS) . . . . .	13-19
13-3	Using the SYS\$SETDDIR System Service (OpenVMS) . . . . .	13-20
13-4	Using \$ASCTIM (OpenVMS) . . . . .	13-20
13-5	Sample Run of CALLTIME (OpenVMS) . . . . .	13-21
13-6	Using LIB\$K_* and LIB\$_* Symbols (OpenVMS) . . . . .	13-22
16-1	Using *DC SET ALIGNMENT Directives . . . . .	16-8

16-2	Using /ALIGNMENT with SYNCHRONIZED . . . . .	16-9
16-3	Comparing /NOALIGN, /ALIGN and /ALIGN=PADDING (Alpha, I64) . . . . .	16-11
16-4	Data Map for /NOALIGNMENT (Alpha, I64) . . . . .	16-11
16-5	Data Map for /ALIGNMENT, -align (Alpha, I64) . . . . .	16-12
16-6	Data Map for /ALIGNMENT=PADDING, -align pad (Alpha, I64) . . . . .	16-12
B-1	Signed and Unsigned Differences . . . . .	B-17
B-2	Illegal Return Value Coding . . . . .	B-18
C-1	Source Code Used in the Sample Debug Sessions . . . . .	C-2

## Figures

1-1	Commands for Developing HP COBOL Programs on Tru64 UNIX . . . . .	1-2
1-2	DCL Commands for Developing Programs . . . . .	1-21
4-1	Organization of the One-Dimensional Table in Example 4-1 . . . . .	4-2
4-2	Organization of Multiple Data Items in a One-Dimensional Table . . . . .	4-3
4-3	Organization of a Table with an Index and an Ascending Search Key . . . . .	4-4
4-4	Organization of a Two-Dimensional Table . . . . .	4-5
4-5	Organization of a Three-Dimensional Table . . . . .	4-5
4-6	Memory Map for Example 4-7 . . . . .	4-7
4-7	Memory Map for Example 4-8 . . . . .	4-8
4-8	Memory Map for Example 4-9 . . . . .	4-9
4-9	Memory Map for Example 4-10 . . . . .	4-9
4-10	Memory Map for Example 4-11 . . . . .	4-10
4-11	Memory Map for Example 4-13 . . . . .	4-11
4-12	Memory Map for Example 4-14 . . . . .	4-12
5-1	Results of the STRING Operation . . . . .	5-3
5-2	Matching Delimiter Characters to Characters in a Field . . . . .	5-19
5-3	Sample INSPECT Statement . . . . .	5-21
5-4	Typical REPLACING Phrase . . . . .	5-22
5-5	The Replacement Argument . . . . .	5-31
6-1	Sequential File Organization . . . . .	6-3
6-2	A Multiple-Volume, Sequential File . . . . .	6-4
6-3	Line Sequential File Organization (Alpha, I64) . . . . .	6-5
6-4	Relative File Organization . . . . .	6-6
6-5	Indexed File Organization . . . . .	6-7
8-1	Multiple Access to a File . . . . .	8-1
8-2	Relationship of Record Locking to File Sharing . . . . .	8-2
8-3	Why a Record-Already-Exists Error Occurs . . . . .	8-16
10-1	Sample Layout Worksheet . . . . .	10-2
10-2	Subtotals, Crossfoot Totals, and Rolled Forward Totals . . . . .	10-5
10-3	Logical Page Area for a Conventional Report . . . . .	10-6
10-4	A 20-Line Logical Page . . . . .	10-11
10-5	A Double-Spaced Master Listing . . . . .	10-12
10-6	Logical Page Areas for a Linage-File Report . . . . .	10-13
10-7	A 28-Line Logical Page . . . . .	10-16

10-8	A 20-Line Logical Page .....	10-20
10-9	Presentation Order for a Logical Page .....	10-26
10-10	Sample Report Using All Seven Report Groups .....	10-27
10-11	First GENERATE Statement .....	10-38
10-12	Subsequent GENERATE Statements .....	10-39
10-13	TERMINATE Statement .....	10-40
10-14	Sample MASTER.DAT File .....	10-43
10-15	EX1006.LIS Listing .....	10-47
10-16	EX1007.LIS Listing .....	10-55
10-17	EX1008.LIS Listing .....	10-64
10-18	EX1009.LIS Listing .....	10-72
10-19	EX1010.LIS Listing .....	10-81
10-20	Printing Labels Four-Up .....	10-83
10-21	Printing Labels Four-Up in Sort Order .....	10-85
11-1	Video Form to Gather Information for a Master File Record .....	11-4
11-2	Screen After the ERASE Statement Executes .....	11-6
11-3	Positioning the Data on Line 19, Column 5 .....	11-7
11-4	Cursor Positioning Using the PLUS Option .....	11-8
11-5	Screen Display with Character Attributes .....	11-10
11-6	Sample Run of Program CONVERT .....	11-12
11-7	Accepting Data with the ON EXCEPTION Option .....	11-14
11-8	Screen Display of NUM-DATA Using the PROTECTED Option .....	11-16
11-9	Accepting Data with the DEFAULT Phrase .....	11-19
11-10	HP COBOL Control Keys on the Standard VT100 Keypad and Keyboard .....	11-23
11-11	HP COBOL Control Keys on a Typical VT200 or Later Keypad and Keyboard .....	11-24
11-12	Screen Display of Program SPECIAL .....	11-28
11-13	Form with ACCEPT WITH EDITING Phrase .....	11-31
11-14	MENU-SCREEN Output (Alpha, I64) .....	11-40
11-15	SCHEDULE-SCREEN Output (Alpha, I64) .....	11-40
12-1	Nesting CALL Statements .....	12-6
12-2	Transfer of Control Flow from a Main Program to Multiple Subprograms .....	12-9
12-3	Accessing Another Program's Data Division .....	12-11
12-4	Defining Data Names in the Linkage Section .....	12-14
12-5	Sharing USE Procedures .....	12-17
12-6	Executing Declaratives with Contained Programs (Rule 1) .....	12-18
12-7	Executing Declaratives Within Contained Programs (Rule 2) .....	12-19
15-1	Sharing Record Areas .....	15-14
15-2	Two-Level Primary Index .....	15-19

## Tables

1-1	Other File Name Suffixes . . . . .	1-3
1-2	HP COBOL Command Flags on Tru64 UNIX . . . . .	1-5
1-3	Main Tools for Program Development and Testing . . . . .	1-19
1-4	COBOL Command Qualifiers . . . . .	1-25
1-5	Commonly Used LINK Qualifiers . . . . .	1-34
2-1	Numeric Relational Operator Descriptions . . . . .	2-3
2-2	Sign Tests . . . . .	2-4
2-3	Numeric Editing . . . . .	2-8
2-4	ROUNDING . . . . .	2-13
3-1	Relational Operator Descriptions . . . . .	3-4
3-2	Nonnumeric Elementary Moves . . . . .	3-7
3-3	Data Movement with Editing Symbols . . . . .	3-9
3-4	Data Movement with the JUSTIFIED Clause . . . . .	3-10
4-1	Subscripting Rules for a Multidimensional Table . . . . .	4-14
4-2	Subscripting with Data Names . . . . .	4-14
5-1	Results of Sample Overflow Statements . . . . .	5-5
5-2	Values Moved into the Receiving Items Based on the Sending Item Value . . . . .	5-7
5-3	Handling a Short Sending Item . . . . .	5-8
5-4	Results of Delimiting with an Asterisk . . . . .	5-9
5-5	Results of Delimiting Multiple Receiving Items . . . . .	5-10
5-6	Results of Delimiting with Two Asterisks . . . . .	5-10
5-7	Results of Delimiting with ALL Asterisks . . . . .	5-11
5-8	Results of Delimiting with ALL Double Asterisks . . . . .	5-11
5-9	Results of Multiple Delimiters . . . . .	5-12
5-10	Values Resulting from Implicit Redefinition . . . . .	5-20
5-11	Relationship Among INSPECT Argument, Delimiter, Item Value, and Argument Active Position . . . . .	5-23
5-12	LEADING Delimiter of the Inspection Operation . . . . .	5-25
5-13	Results of the Scan with Separate Tallies . . . . .	5-26
6-1	HP COBOL File Organizations—Advantages and Disadvantages . . . . .	6-2
6-2	Record Format Availability . . . . .	6-8
6-3	Valid I/O Statements for Sequential Files . . . . .	6-28
6-4	Valid I/O Statements for Line Sequential Files (Alpha, I64) . . . . .	6-28
6-5	Valid I/O Statements for Relative Files . . . . .	6-32
6-6	Valid I/O Statements for Indexed Files . . . . .	6-34
6-7	Indexed File—ISAM Mapping . . . . .	6-48
8-1	File-Sharing Options (OpenVMS) . . . . .	8-10
8-2	File-Sharing Options (Tru64 UNIX) . . . . .	8-11
8-3	File Status Values Used in a File-Sharing Environment . . . . .	8-12
8-4	RMS-STTS Values Used in a File-Sharing Environment (OpenVMS) . . . . .	8-14
8-5	Manual Record Locking Combinations . . . . .	8-21
10-1	Report Writer Report Group Types . . . . .	10-26
10-2	Results of Group Indicating . . . . .	10-87
11-1	Available Character Attributes by Terminal Type . . . . .	11-9

11-2	HP COBOL Characters Returned for Cursor Positioning, Program Function, Function, Keypad, and Keyboard Keys . . . . .	11-20
11-3	Key Functions for the EDITING Phrase . . . . .	11-28
11-4	Character Attribute Clauses for Screen Description Formats (Alpha, I64) . . . . .	11-32
11-5	Color Table . . . . .	11-34
12-1	Calls to COBOL Programs (Alpha, I64) . . . . .	12-20
12-2	C Routine Called by Statement: CALL "Job1" . . . . .	12-33
12-3	C Invocation to Call COBOL PROGRAM-ID "Job2" . . . . .	12-33
13-1	OpenVMS Alpha and I64 Register Usage . . . . .	13-2
13-2	Run-Time Library Facilities (OpenVMS) . . . . .	13-4
13-3	System Services (OpenVMS) . . . . .	13-4
13-4	COBOL Implementation of the OpenVMS Data Types (OpenVMS) . . . . .	13-8
16-1	Boundaries for Naturally Aligned Binary Data (Alpha, I64) . . . . .	16-4
16-2	Alignment and Padding Order of Precedence (Alpha, I64) . . . . .	16-7
B-1	Cross-Platform Compatibility of COBOL Features . . . . .	B-1
B-2	Qualifiers Shared by HP COBOL for OpenVMS Alpha, I64, and VAX and Equivalent Tru64 UNIX Flags and Options . . . . .	B-4
B-3	HP COBOL on Alpha and I64 Options Not Available on VAX . . . . .	B-6
B-4	HP COBOL for OpenVMS VAX Specific Qualifiers . . . . .	B-7
C-1	Oracle CDD/Repository Data Types: Level of Support in HP COBOL on OpenVMS . . . . .	C-19
D-1	Recognized Foreign Reserved Words . . . . .	D-2



---

# Preface

This manual provides information to help you develop HP COBOL programs for the OpenVMS Alpha, OpenVMS Industry Standard 64, OpenVMS VAX, and Tru64 UNIX platforms.

HP COBOL is the new name for what has formerly been known as Compaq COBOL, DEC COBOL, DIGITAL COBOL, and VAX COBOL. HP COBOL, unmodified, refers to the following products:

- HP COBOL for OpenVMS Industry Standard 64
- HP COBOL for OpenVMS Alpha
- HP COBOL for Tru64 UNIX
- HP COBOL for OpenVMS VAX

Any references to the former names in product documentation or other components should be construed as references to the HP COBOL names.

## Intended Audience

This manual is intended for experienced applications programmers who have a thorough understanding of the COBOL language. Some familiarity with your operating system is also recommended. This is not a tutorial manual.

If you are a new COBOL user, you may need to read introductory COBOL textbooks or take COBOL courses. Additional prerequisites are described at the beginning of each chapter or appendix, if appropriate.

## Document Structure

This manual is organized as follows:

- Chapter 1 describes how to create, compile, link, and run HP COBOL programs and how to develop programs at the command level.
- Chapter 2 describes how the HP COBOL compiler stores, represents, moves, and manipulates numeric data.
- Chapter 3 describes how the HP COBOL compiler stores, represents, moves, and manipulates nonnumeric data.
- Chapter 4 describes how to define, initialize, and access tables.
- Chapter 5 describes how to perform text manipulation using the STRING, UNSTRING, and INSPECT statements.
- Chapter 6 describes I/O services provided by the operating systems, including record management services.
- Chapter 7 describes how to include exception handling routines in HP COBOL programs.

- Chapter 8 describes file sharing and record locking for sequential, relative, and indexed files.
- Chapter 9 describes how to sort and merge files using the SORT and MERGE statements.
- Chapter 10 describes how to produce printed reports.
- Chapter 11 describes screen handling using the HP COBOL ACCEPT and DISPLAY statements.
- Chapter 12 describes how HP COBOL programs communicate with each other or with non-COBOL programs through the CALL statement and external data.
- Chapter 13 describes the use of HP COBOL in the OpenVMS Common Language Environment.
- Chapter 14 describes how to use the REFORMAT utility, which converts terminal format source programs to conventional ANSI format and converts conventional ANSI format source programs to terminal format.
- Chapter 15 presents guidelines for using the HP COBOL compiler optimization features.
- Chapter 16 describes how to use compile-time and run-time features to optimize the use of system resources while also maximizing run-time performance.
- Appendix A contains a list of HP COBOL specifications and limits on the Tru64 UNIX and OpenVMS systems.
- Appendix B describes compatibility and portability issues between HP COBOL for OpenVMS VAX and HP COBOL on the OpenVMS I64, Tru64 UNIX and OpenVMS Alpha systems.
- Appendix C describes optional programming productivity tools available on OpenVMS systems and Tru64 UNIX systems.
- Appendix D describes porting assistance for migrating applications between other COBOL compilers and HP COBOL.
- The Index indexes and references terms in this manual.

## Associated Documents

The following documents contain additional information directly related to various topics in this manual:

### ***HP COBOL Reference Manual***

This manual describes the concepts and rules of the HP COBOL programming language under the supported operating systems.

### **Release Notes**

Consult the HP COBOL release notes for your installed version for late corrections and new features.

On the OpenVMS operating systems, the release notes are in:

```
SYS$HELP:COBOL $nnn$ .RELEASE_NOTES (ASCII text)
SYS$HELP:COBOL $nnn$ _RELEASE_NOTES.PS
```



where *nnn* is the version and release number, for example, 028 for Version 2.8.

On the Tru64 UNIX operating system, the release notes are in:

`/usr/lib/cmplrs/cobol/relnotes`

***HP COBOL for OpenVMS Alpha and I64 Systems Installation Guide***

This manual provides information on how to install HP COBOL on the OpenVMS Alpha and OpenVMS I64 operating systems.

***Compaq COBOL for OpenVMS VAX Systems Installation Guide***

This manual provides information on how to install HP COBOL on the OpenVMS VAX operating system.

***Compaq COBOL for Tru64 UNIX Systems Installation Guide***

This manual provides information on how to install HP COBOL on the Tru64 UNIX operating system.

***HP COBOL DBMS Database Programming Manual***

This manual provides information on using HP COBOL for database programming with Oracle CODASYL DBMS on the OpenVMS Alpha, OpenVMS I64, and OpenVMS VAX operating systems.

**The OpenVMS Documentation Set**

This set contains information about using the features of the OpenVMS Alpha, OpenVMS I64, and OpenVMS VAX operating systems and their tools, including the OpenVMS Debugger.

**The DECset Documentation**

This documentation contains information about using DECset.

**The Tru64 UNIX Documentation Set**

This set contains information about using the features of the Tru64 UNIX operating system and its tools.

## Related Documents

For additional information about HP OpenVMS products and services, visit the following World Wide Web address:

<http://www.hp.com/go/openvms>

## Conventions Used in This Document

The following product names may appear in this manual:

- HP OpenVMS Industry Standard 64 for Integrity servers
- OpenVMS I64
- I64

All three names—the longer form and the two abbreviated forms—refer to the version of the OpenVMS operating system that runs on the Intel® Itanium® architecture.

The following table lists the conventions used in this manual:

Convention	Meaning
Ctrl/x	A sequence such as Ctrl/x indicates that you must hold down the key labeled Ctrl while you press another key or a pointing device button.
◆	A diamond signals the end of a section of system-specific information. The beginning of a system-specific section is identified in the text or header as Alpha (meaning both OpenVMS Alpha and Tru64 UNIX Alpha, and excluding OpenVMS VAX); I64 (meaning OpenVMS I64); as OpenVMS (meaning OpenVMS Alpha, OpenVMS I64, and OpenVMS VAX); or as Tru64 UNIX.
<u>RECORD KEY IS</u>	Underlined uppercase words are required when used in a general format. Uppercase words not underlined are optional.
sortfile	Lowercase words used in a general format are generic terms that indicate entries you must provide.
{ }	Braces used in a general format enclose lists from which you must choose only one item. For example:  $\left\{ \begin{array}{c} \underline{\text{SEQUENTIAL}} \\ \underline{\text{RANDOM}} \\ \underline{\text{DYNAMIC}} \end{array} \right\}$
[ ]	Brackets used in a general format enclose optional items from which you can choose none or one. For example:  $\left[ \begin{array}{c} \underline{\text{RECORD}} \\ \underline{\text{ALL RECORDS}} \end{array} \right]$
{     }	Choice indicators, vertical lines inside a set of braces, used in a general format enclose lists from which you must choose one or more items, using each item chosen only once. For example:  $\left\{ \left  \begin{array}{c} \underline{\text{COMMON}} \\ \underline{\text{INITIAL}} \end{array} \right  \right\}$
...	A horizontal ellipsis indicates that the item preceding the ellipsis can be repeated. For example:  { switch-name } ...
.	A vertical ellipsis indicates that not all of the statements are shown.
format of examples	Program examples are shown in terminal format, rather than in ANSI standard format.

Convention	Meaning
special-character words	The following symbols, when used in a general format, constitute required special-character words: <ul style="list-style-type: none"> <li>Plus sign (+)</li> <li>Minus sign (-)</li> <li>Single (=) and double (==) equal signs</li> <li>Less than (&lt;) or greater than (&gt;) symbols</li> <li>Less than or equal to (&lt;=) and greater than or equal to (&gt;=) symbols</li> <li>Period (.)</li> <li>Colon (:)</li> <li>Single (*) and double (**) asterisks</li> <li>Slash (/)</li> <li>Left parenthesis ( ( ) or right parenthesis ( ) )</li> </ul>
quotation mark	The term quotation mark is used to refer to the double quotation mark character (").
apostrophe	The term apostrophe is used to refer to the single quotation mark character ( ' ).
user input	In examples, user input (what you enter) is shown as monospaced text.
extensions	Hewlett-Packard extensions to the 1985 ANSI COBOL Standard are color coded in blue or gray. Note that the term <i>extension</i> in this manual means an HP extension to the ANSI COBOL Standard. (Some of the Alpha extensions are included in the X/Open CAE Standard for the COBOL language.)
<b>report file</b>	Bold type indicates a new term.
<i>italics</i>	Italic type indicates important information, complete titles of manuals, or variables. Variables include generic terms (lowercase variable elements in syntax) when referred to in text; and information that varies in system output (error <i>number</i> ) and in command lines (BASIC <i>file-name</i> ) in text.
full-file-name	This syntax term refers to the name of a file and the device and directory, or path, in which it is located. For example: <p>DISK2\$:[HOME.PUBLIC]FILENAME.TXT; (OpenVMS file specification)</p> <p>/disk2/home/public/filename.txt (Tru64 UNIX file specification)</p>
compiler option	This term refers to command-line qualifiers (OpenVMS systems) or flags (Tru64 UNIX systems). For example: <p>/LIST (OpenVMS qualifier)</p> <p>-list (Tru64 UNIX flag)</p>
COBOL	This term refers to language information common to ANSI-85 COBOL and HP COBOL.
<span style="border: 1px solid black; padding: 2px;">Enter</span>	A boxed symbol indicates that you must press a key on the terminal; for example, <span style="border: 1px solid black; padding: 2px;">Enter</span> indicates that you press the Enter key.
<span style="border: 1px solid black; padding: 2px;">Tab</span>	This symbol indicates a nonprinting tab character.
<span style="border: 1px solid black; padding: 2px;">Ctrl/x</span>	The symbol <span style="border: 1px solid black; padding: 2px;">Ctrl/x</span> indicates that you hold down the key labeled CTRL while you press another key, for example, <span style="border: 1px solid black; padding: 2px;">CtrlC</span> or <span style="border: 1px solid black; padding: 2px;">CtrlO</span> .
\$	The dollar sign (\$) represents the OpenVMS system prompt.

Convention	Meaning
%	The percent sign (%) represents the Tru64 UNIX system prompt.

## References

The following table shows certain references and their respective meanings in this manual:

Reference	Meaning
Alpha	OpenVMS Alpha or Tru64 UNIX operating system
OpenVMS	OpenVMS Alpha or OpenVMS I64 or OpenVMS VAX operating system
Tru64 UNIX	Tru64 UNIX operating system
DECset	DECset for OpenVMS

Tru64 UNIX was formerly known as Compaq Tru64 Unix, DEC OSF/1, or as DIGITAL UNIX. HP COBOL was formerly known as Compaq COBOL, DIGITAL COBOL, or DEC COBOL. HP COBOL for OpenVMS VAX was formerly known as Compaq COBOL for OpenVMS VAX, VAX COBOL, or as DIGITAL VAX COBOL.

## Acknowledgment

COBOL is an industry language and is not the property of any company or group of companies, or of any organization or group of organizations.

No warranty, expressed or implied, is made by any contributor or by the CODASYL COBOL Committee as to the accuracy and functioning of the programming system and language. Moreover, no responsibility is assumed by any contributor, or by the committee, in connection therewith.

The authors and copyright holders of the copyrighted material used herein are as follows: FLOW-MATIC (trademark of Unisys Corporation), Programming for the UNIVAC (R) I and II, Data Automation Systems, copyrighted 1958, 1959, by Unisys Corporation; IBM Commercial Translator Form No. F28-8013, copyrighted 1959 by IBM; FACT, DSI 27A5260-2760, copyrighted 1960 by Minneapolis-Honeywell.

They have specifically authorized the use of this material, in whole or in part, in the COBOL specifications. Such authorization extends to the reproduction and use of COBOL specifications in programming manuals or similar publications.

## How to Order Additional Documentation

For information about how to order additional documentation, visit the following World Wide Web address:

<http://www.hp.com/go/openvms/doc/order>

## Reader's Comments

HP welcomes your comments on this manual. Please send comments to either of the following addresses:

Internet

**[openvmsdoc@hp.com](mailto:openvmsdoc@hp.com)**

Postal Mail

Hewlett-Packard Company  
OSSG Documentation Group, ZKO3-4/U08  
110 Spit Brook Rd.  
Nashua, NH 03062-2698



---

# Developing HP COBOL Programs

HP COBOL is a family of powerful COBOL compilers produced by Hewlett-Packard Company. HP COBOL operates comfortably in the HP common language environment; on Alpha, it is based on GEM, which is the highly advanced code generator and optimizer that Hewlett-Packard uses in its Alpha family of languages, which includes COBOL, C, C++, FORTRAN, BASIC, Ada, and PASCAL. In addition to standard COBOL features, HP COBOL includes extensions that make new application development efficient and effective, with features helpful in porting legacy COBOL programs to OpenVMS Alpha, OpenVMS I64, and Tru64 UNIX systems.

Developing software applications with HP COBOL will be a familiar process. You set up your development environment, create your source, compile, link, and run. A few of the specific tasks are:

- Choosing a reference format: terminal or ANSI
- Carefully considering Alpha and Itanium® architecture system resources; for example, you might invest more system resources at compile time to get faster execution at run time
- Using various system-independent features for program development

## 1.1 Developing Programs on Tru64 UNIX

This section briefly describes the Tru64 UNIX commands (commands used at the operating system prompt) that you use to create, compile, link, and run HP COBOL programs on Tru64 UNIX systems.

### 1.1.1 Creating an HP COBOL Program on Tru64 UNIX

Use a text editor, such as `vi` or `emacs`, to create and revise your source files. For instance, to edit the file `prog1.cob` using the `vi` editor, type:

```
% vi prog1.cob
```

Figure 1–1 shows the basic steps in HP COBOL program development on Tru64 UNIX systems.

# Developing HP COBOL Programs

## 1.1 Developing Programs on Tru64 UNIX

Figure 1–1 Commands for Developing HP COBOL Programs on Tru64 UNIX

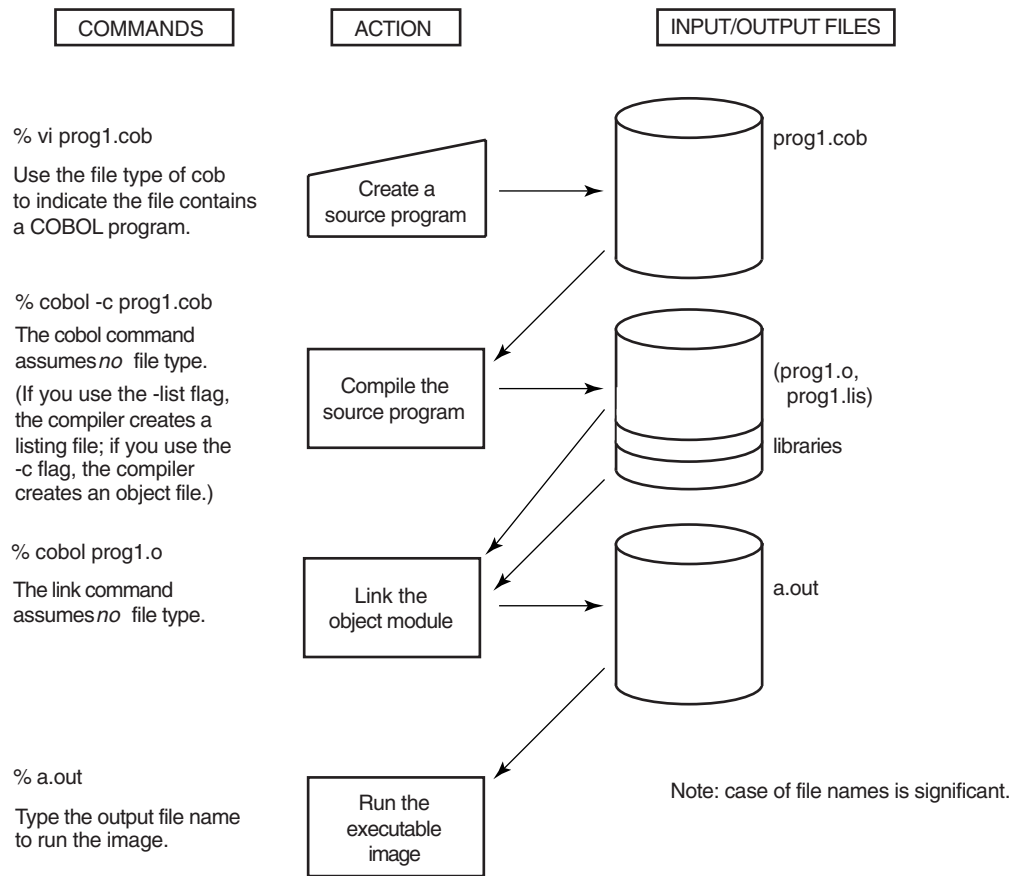

VM-0610A-AI

When naming a source file, choose one of the four file name extensions that the cobol compiler recognizes as COBOL file suffixes. These suffixes are:

- .cob
- .COB
- .cbl
- .CBL

Table 1–1 shows other file name suffixes.



# Developing HP COBOL Programs

## 1.1 Developing Programs on Tru64 UNIX

**Table 1–1 Other File Name Suffixes**

Suffix	Description
.c	Identifies C language files passed to the C compiler driver <code>cc</code> , which performs additional command line parsing before invoking the C language compiler.
.s	Identifies assembler files passed to <code>cc</code> . HP COBOL does not generate <code>.s</code> files.
.o	Identifies object files passed to <code>cc</code> , which are in turn passed to <code>ld</code> .
.a	Identifies archive object libraries passed to <code>cc</code> , which are in turn passed to <code>ld</code> . All routines in the specified object library will be searched during linking to resolve external references. This is one method of specifying special libraries for which the <code>cobol</code> command does not automatically search.
.so	Identifies shared object libraries passed to <code>cc</code> , which are in turn passed to <code>ld</code> . All routines in the specified object library will be searched during linking to resolve external references. This is one method of specifying special libraries for which the <code>cobol</code> command does not automatically search.

The following `cobol` command compiles the program named `prog1.cob` and automatically uses the linker `ld` to link the main program into an executable program file named `a.out` (the name used if you do not specify a name):

```
% cobol prog1.cob
```

The `cobol` command automatically passes a standard default list of Tru64 UNIX and HP COBOL libraries to the `ld` linker. If all external routines used by a program reside in these standard libraries, additional libraries or object files are not specified on the `cobol` command line.

If your path definition includes the directory containing `a.out`, you can run the program by simply typing its name:

```
% a.out
```

If the executable image is not in your current directory path, specify the directory path in addition to the file name.

### The COPY Statement and Libraries

As you write a program, you can use the `COPY` statement in your source program to include text from another file. With the `COPY` statement, separate programs can share common source text kept in libraries, reducing development and testing time as well as storage. The *HP COBOL Reference Manual* explains how to use the `COPY` statement.

### Special Considerations for Routines Named “main”

If you have a program or routine named “main,” declared either in an HP COBOL or other module, your application may not work correctly. The HP COBOL library contains a routine named “main,” which initializes the run-time environment for the `CALL` by data name statements, extended `ACCEPT` and `DISPLAY` statements, and some error handling. When your application also declares a “main,” your routine preempts the HP COBOL routine, and the run-time initialization is not performed.

Hewlett-Packard recommends that you not name an HP COBOL program “main.”

If you have a C routine named “main,” you can work around this problem by having the “main” routine directly call the HP COBOL initialization routine, `cob_init`. The `cob_init` routine interface (in C) is as follows:

# Developing HP COBOL Programs

## 1.1 Developing Programs on Tru64 UNIX

```
void cob_init (          /* init the RTL */
               int argc, /* argument count */
               char **argv, /* arguments */
               char **envp /* environment variable pointers */ )
```

### 1.1.2 Compiling an HP COBOL Program on Tru64 UNIX

Compilation does the following for you:

- Detects errors in your program syntax
- Displays compiler messages on your terminal screen
- Generates machine language instructions from valid source statements
- Groups the instructions into an object module for the linker `ld`

To compile your program, use the `cobol` command.

#### The COBOL Command Driver

The `cobol` command invokes a compiler driver that is the actual user interface to the HP COBOL compiler. It accepts a list of command flags and file names and causes one or more processors (compiler, assembler, or linker) to process each file.

After the HP COBOL compiler processes the appropriate files to create one or more object files, the compiler driver passes a list of files, certain flags, and other information to the `cc` compiler. After the `cc` compiler (the default C compiler on your system) processes relevant files and information, it passes certain information (such as `.o` object files) to the `ld` linker. The `cobol` command executes each processor; if any processor returns other than normal status, further processing is discontinued and the HP COBOL compiler displays a message identifying the processor (and its returned status, in hexadecimal) before terminating its own execution.

#### 1.1.2.1 Format of the COBOL Command on Tru64 UNIX

The `cobol` command has the following format:

```
cobol [-flags [options]]... filename[.suffix] [filename[.suffix]]... [-flags [options]]...
```

##### **-flags [options]**

Indicates either special actions to be performed by the compiler or linker, or special properties of input or output files. For details about command-line flags, see Section 1.1.2.2. If you specify the `-lstring` flag (which indicates libraries to be searched by the linker) or an object library file name, place it after the file names and after other flags.

##### **filename.suffix**

Specifies the source files containing the program units to be compiled, where the file name has a suffix that indicates the type of file used. The recognized COBOL *suffix* characters are `.cob`, `.COB`, `.cbl`, and `.CBL`.

Note that the compiler driver checks for a valid suffix on *filename*. If you omit *suffix*, or if it is not one of the types recognized by the `cobol` command, the file is assumed to be an object file and is passed directly to the linker.

An example `cobol` command line would be:

```
% cobol -v test.cob pas.o
```

This command specifies the following:

- The `-v` flag displays the compilation and link passes with their arguments and files, including the libraries passed to `ld`.

## Developing HP COBOL Programs

### 1.1 Developing Programs on Tru64 UNIX

- The file `test.cob` is passed to the HP COBOL compiler for compilation. The resulting object file is then linked.
- The object file `pas.o` is passed directly to the linker.

As an additional example, you might find that your compiler command lines are getting rather long, as shown in the following example:

```
% cobol -rsv foreign_extensions -flagger high_fips -warn information zeroes.cob
```

To work around this, you may truncate compiler flag options (arguments) to their shortest unambiguous form, as follows:

```
% cobol -rsv for -flagger high -warn info zeroes.cob
```

#### 1.1.2.2 COBOL Command Flags

Flags to the `cobol` command affect how the compiler processes a file. The simplest form of the `cobol` command is often sufficient.

If you compile parts of your program (compilation units) using multiple `cobol` commands, flags that affect the execution of the program should be used consistently for all compilations, especially if data will be shared or passed between procedures.

For a complete list of HP COBOL flags, see Table 1–2. For more information about the HP COBOL flags, access the reference (man) page for COBOL at the Tru64 UNIX system prompt. For example:

```
% man cobol
```

**Table 1–2 HP COBOL Command Flags on Tru64 UNIX**

Flag	Default
<code>-align [padding]</code>	off
<code>-ansi</code>	off
<code>-arch</code>	<code>-arch generic</code>
<code>-arithmetic native</code>	<code>-arithmetic native</code>
<code>-arithmetic standard</code>	<code>-arithmetic native</code>
<code>-C</code>	off
<code>-c</code>	on
<code>-call_shared</code>	on
<code>-check all</code>	off
<code>-check [no]bounds</code>	<code>-check nobounds</code>
<code>-check [no]decimal</code>	<code>-check nodecimal</code>
<code>-check [no]perform</code>	<code>-check nopperform</code>
<code>-check none</code>	on
<code>-conditionals [selector]</code>	off
<code>-convert [no]leading_blanks</code>	<code>-convert noleading_blanks</code>
<code>-copy</code>	off
<code>-copy_list</code>	off

(continued on next page)

# Developing HP COBOL Programs

## 1.1 Developing Programs on Tru64 UNIX

Table 1–2 (Cont.) HP COBOL Command Flags on Tru64 UNIX

Flag	Default
-cord	off
-cross_reference	off
-cross_reference alphabetical	off
-cross_reference declared	off
-D <i>num</i>	off
-display_formatted	off
-feedback <i>file</i>	off
-fips 74	off
-flagger [option]	off
-granularity byte, -granularity long, -granularity quad	-granularity quad
-g0	off
-g1	on
-g2 or -g	off
-g3	off
-include	off
-K	off
-L	off
-Ldir	off
-list	off
-lstring	off
-mach or -machine_code	off
-map	off
-map alphabetical	off
-map declared	off
-math_intermediate cit3, -math_intermediate cit4, -math_intermediate float	-math_intermediate float
-names as_is, -names lower, -names lowercase, -names upper, -names uppercase	-names lowercase
-nationality japan, -nationality us	-nationality us
-nolocking	off
-noobject	off
-non_shared	-call_shared
-nowarn	off
-00	off

(continued on next page)

## Developing HP COBOL Programs

### 1.1 Developing Programs on Tru64 UNIX

**Table 1–2 (Cont.) HP COBOL Command Flags on Tru64 UNIX**

Flag	Default
-01	off
-02	off
-03	off
-04 or -0	on
-o <i>output</i>	a.out
-p0	on
-p1 or -p	off
-relax_key_checking or -rkc	off
-rsv [no]200x	-rsv no200x
-rsv [no]foreign_extensions	-rsv noforeign_extensions
-rsv [no]xopen	-rsv xopen
-seq or -sequence_check	off
-shared	-call_shared
-show code	off
-show copy	off
-show xref	off
-std or -std 85	on
-std [no]mia	-std nomia
-std [no]syntax	-std nosyntax
-std [no]v3	-std nov3
-std [no]xopen	-std xopen
-T <i>num</i>	off
-taso	off
-tps	off
-trunc	off
-tune	-tune generic
-V	off
-v	off
-w	off
-warn	-warn other
-warn all	off
-warn [no]information	-warn noinformation
-warn [no]other	-warn other
-warn none	off
-xref, -xref_stdout	off

#### Technical Notes:

1. If your program compile generates Errors (E-level diagnostics on OpenVMS), the link phase of the two steps taken by the compiler driver will be aborted and the object file(s) deleted. You can override this deletion by specifying the -c flag:

# Developing HP COBOL Programs

## 1.1 Developing Programs on Tru64 UNIX

```
% cobol -c test.cob
% cobol test.o
```

The HP COBOL compiler driver (see Section 1.1.2) controls a sequence of operations (as required): compiling, assembling, linking. The `-c` flag signals the compiler driver to break the sequence.

(For additional information, see The COBOL Command Driver description (earlier in this chapter), Section 1.1.2.12, and the `-c` description under `man cobol`.)

2. The `-tps` flag causes the HP COBOL compiler to use an external file handler (produced by a third party), providing increased flexibility in cross platform, transaction processing application development. See Section 1.1.2.3 for more information.
3. Specifying the `-xref_stdout` option directs the compiler to output the data file to standard output.
4. Any copy file that contains a `PROGRAM-ID` or `END PROGRAM` statement for a program must contain that entire program.

### 1.1.2.3 External File Handler Support

The `-tps` flag allows HP COBOL applications to make use of ACMSxp, the Application Control and Management System/Cross-Platform Edition.

`-tps` specifies that files are part of a transaction processing system, and enables Encina Structured File System (SFS) record storage for applicable files. It is intended to be used in conjunction with the Transarc Encina external file handler and ACMSxp, allowing access to data in a wide variety of databases, without the need to write code in the language of the databases. This approach provides access to transaction processing technology, and incorporates industry standards for data communications and distributed computing. ACMSxp conforms to the the Multivendor Integration Architecture (MIA).

COBOL is one of the languages approved by MIA for transaction processing (TP) client programs, customer-written presentation procedures, and processing procedures. For database access, Structured Query Language (SQL) is the MIA-required access language. The SQL is embedded in COBOL and C.

Refer to the ACMSxp documentation for full details. Additional information can also be found in published Distributed Computing Environment (DCE) documentation.

### 1.1.2.4 Specifying Multiple Files and Flags

The `cobol` command can specify multiple file names and multiple flags. Multiple file names are delimited by spaces. If appropriate, each file name can have a different suffix. The file name suffix could result in the following actions:

- Calling another language compiler, such as the C compiler
- Passing object files directly to the linker, which the linker combines with other object files
- Passing an object library to the linker, which the linker uses to search for unresolved global references

When a file is not in your current working directory, specify the directory path before the file name.

## Developing HP COBOL Programs

### 1.1 Developing Programs on Tru64 UNIX

#### 1.1.2.5 Compiling Multiple Files

An entire set of source files can be compiled and linked together using a single cobol command:

```
% cobol -o calc mainprog.cob array_calc.cob calc_aver.cob
```

This cobol command:

- Uses the `-o` flag to specify the name of the executable program as `calc`
- Compiles the file `array_calc.cob`
- Compiles the file `calc_aver.cob`
- Compiles the file `mainprog.cob`, which contains the main program
- Uses `ld` to link both the main program and object files into an executable program file named `calc`

The files can also be compiled separately, as follows:

```
% cobol -c array_calc.cob
% cobol -c calc_aver.cob
% cobol -o calc_mainprog.cob array_calc.o calc_aver.o
```

In this case, the `-c` option prevents linking and retains the `.o` files. The first command creates the file `array_calc.o`. The second command creates the file `calc_aver.o`. The last command compiles the main program and links the object files into the executable program named `calc`.

If your path definition includes the directory containing `calc`, you can run the program by simply typing its name:

```
% calc
```

You can compile multiple source files by concatenating them:

```
% cat prog1.cob prog2.cob prog3.cob > com1.cob
% cat prog1.cob prog2.cob > com2.cob
% cobol -c com1.cob com2.cob
```

The resulting file names are `com1.o` and `com2.o`. The OpenVMS Alpha and I64 equivalent to this is:

```
$ COBOL prog1+prog2+prog3,progb1+progb2
```

#### 1.1.2.6 Debugging a Program

To debug a program using the Ladebug Debugger, compile the source files with the `-g` flag to request additional symbol table information for source line debugging in the object and executable program files. The following cobol command also uses the `-o` flag to name the executable program file `calc_debug`:

```
% cobol -g -o calc_debug mainprog.cob array_calc.cob calc_aver.cob
```

To debug an executable program named `calc_debug`, type the following command:

```
% ladebug calc_debug
```

For more information on running the program within the debugger, refer to the *Ladebug Debugger Manual*.

Pay attention to compiler messages. Informational and warning messages (as well as error-level messages) do not prevent the production of an object file, which you can link and execute. However, the messages sometimes point out otherwise undetected logic errors, and the structure of the program might not be what you intended.

# Developing HP COBOL Programs

## 1.1 Developing Programs on Tru64 UNIX

### 1.1.2.7 Output Files: Object, Executable, Listing, and Temporary Files

The output produced by the `cobol` command includes:

- An object file, if you specify the `-c` flag on the command line
- An executable file, if you omit the `-c` flag
- A listing file, if you specify the `-v` flag

If the environment variable `TMPDIR` is set, the value is used as the directory for temporary files.

You control the production of these files by specifying the appropriate flags on the `cobol` command line. Unless you specify the `-c` flag, the compiler generates a single temporary object file, whether you specify one source file or multiple source files separated by blanks. The `ld` linker is then invoked to link the object file into one executable image file.

The object file is in Tru64 UNIX extended coff format. The object file provides the following information:

- The name of the entry point. It takes this name from the program name in the first `PROGRAM-ID` paragraph in the source program.
- A list of variables that are declared in the module. The linker uses this information when it binds two or more modules together and must resolve references to the same names in the modules.
- A symbol table and a source line correlation table (if you request them with the `-g` flag, for debugging). A symbol table is a list of the names of all external and internal variables within a module, with definitions of their locations. The source line correlation table associates lines in your source file with lines in your program. These tables are of use in debugging.

If severe errors are encountered during compilation or if you specify certain flags such as `-c`, linking does not occur.

### 1.1.2.8 Naming Output Files

To specify a file name (other than `a.out`) for the executable image file, use the `-o output` flag, where *output* specifies the file name. You can also use the `mv` command to rename the file. The following command requests a file name of `prog1.out` for the source file `test1.cob`:

```
% cobol -o prog1.out test1.cob
```

Besides specifying the name of the executable image file, you can use the `-o output` flag to rename the object file if you specified the `-c` flag. If you specify the `-c` flag and omit the `-o output` flag, the name of the first specified file is used with a `.o` suffix substituted for the source file suffix.

### 1.1.2.9 Temporary Files

Temporary files created by the compiler or a preprocessor reside in the `/tmp` directory and are deleted (unless the `-K` flag is specified). You can set the environment variable `TMPDIR` to specify a directory to contain temporary files if `/tmp` is not acceptable.

To view the file name and directory where each temporary file is created, use the `-v` flag. To create object files in your current working directory, use the `-c` flag. Any object files (`.o` files) that you specify on the `cobol` command line are retained.



### 1.1.2.10 Examples of the COBOL Command

The following examples show the use of the `cobol` command. Each command is followed by a description of the output files that it produces.

1. `% cobol -V aaa.cob bbb.cob ccc.cob`

The HP COBOL source files `aaa.cob`, `bbb.cob`, and `ccc.cob` are compiled into temporary object files. The temporary object files are passed to the `ld` linker. The `ld` linker produces the executable file `a.out`. The `-V` flag causes the compiler to create the listing files `aaa.lis`, `bbb.lis`, and `ccc.lis`.

2. `% cobol -V *.cob`

HP COBOL source files with file names that end with `.cob` are compiled into temporary object files, which are then passed to the `ld` linker. The `ld` linker produces the `a.out` file.

When the compilation completes, the `cobol` driver returns one of the following status values:

- 0—SUCCESS
- 1—FAILURE
- 2—SUBPROCESS\_FAILURE (`cobol` or `cc`)
- 3—SIGNAL

### 1.1.2.11 Other Compilers

You can compile and link multilanguage programs using a single `cobol` command.

The `cobol` command recognizes C or Assembler program files by their file suffix characters and passes them to the `cc` compiler for compilation. Before compilation, `cc` applies the `cpp` preprocessor to files that it recognizes, such as any file with a `.c` suffix.

Certain flags passed to `cc` are passed to the `ld` linker.

### 1.1.2.12 Interpreting Messages from the Compiler

The HP COBOL compiler identifies syntax errors and violations of language rules in the program. If the compiler finds any errors, it writes messages to the `stderr` output file and any listing file. If you enter the `cobol` command interactively, the messages are displayed on your terminal.

Compiler messages have the following format:

```
cobol: severity: filename, line n, message-text
[text-in-error]
-----^
```

The pointer (`--^`) indicates the exact place on the source line where the error was found. For example, the following error message shows the format and message text in a listing file when an `END DO` statement was omitted:

```
cobol: Severe: disp.cob, line 7: Missing period is assumed
      05 VAR-1 PIC X.
-----^
```

The severity level is one of the following:

Severe	The compiler does not produce an object module. You must correct the error before you can compile the program to produce an object module.
--------	--

# Developing HP COBOL Programs

## 1.1 Developing Programs on Tru64 UNIX

Error	The compiler makes an assumption about what you intended and continues. However, the compiler's assumption may not relate to your intention. Correct the error.
Warning	The compiler attempts to correct the error in the statement, but you should verify that the compiler's action is acceptable. Otherwise, your program may produce unexpected results.
Informational	This message usually appears with other messages to inform you of specific actions taken by the compiler. No action is necessary on your part.

Any messages issued during the compilation are inserted in the listing file. A listing file is useful for debugging the source code. Use the `-V` or `-list` flag to produce a listing; you may also use `-cross_reference`, `-copy_list`, `-flagger`, `-machine_code`, `-map`, and/or `-warn`, all of which affect the contents of the listing file.

Diagnostic messages provide information for you to determine the cause of an error and correct it. If the compiler creates a listing file, it writes the messages to the listing file.

### 1.1.3 Linking an HP COBOL Program on Tru64 UNIX

Once your program has compiled successfully, the system passes the resulting object file (which has the suffix `.o` by default) to the linker to create an executable image file. By default, the executable image file has the name `a.out`. (To change this default, specify `-o filename` on the `cobol` command line.) This file can be run on the Tru64 UNIX system.

The `ld` linker provides the following primary functions:

- Generates appropriate information in the executable image for virtual memory allocation
- Resolves symbolic references among object files being linked, including whether to search in archive or shared object libraries
- Assigns values to relocatable global symbols
- Performs relocation

The linker produces an executable program image with a default name of `a.out`.

When you enter a `cobol` command, the `ld` linker is invoked automatically unless a compilation error occurs or you specify the `-c` flag on the command line.

#### 1.1.3.1 Specifying Object Libraries for Linking

You can specify object libraries on the COBOL command line by using certain flags or by providing the file name of the library. These object libraries are also searched by `ld` for unresolved external references.

When `cobol` specifies certain libraries to `ld`, it provides a standard list of COBOL library file names to `ld`. The `ld` linker tries to locate each of these library file names in a standard list of library directories. That is, `ld` attempts to locate each object library file name first in one directory, then in the second, and then in the third directory on its search list of directories.

To display a list of the compilers invoked, files processed, and libraries accessed during linking, specify the `-v` flag.

## Developing HP COBOL Programs

### 1.1 Developing Programs on Tru64 UNIX

In addition to an object file created by the compiler, any linker flags and object files specified on the `cobol` command are also passed to the `ld` linker. The linker loads object files according to the order in which they are specified on the command line. Because of this, you must specify object libraries *after* all source and object files on the `cobol` command line.

To help identify undefined references to routines or other symbols in an object module, consider using the `nm` command. For instance, in the following example the `nm` command filtered by the `grep` command lists all undefined (U) symbols:

```
% cobol -c ex.cob
% nm -o ex.o | grep U
```

If the symbol is undefined, U appears in the column before the symbol name. Any symbols with a U in their names can also be displayed by this use of `grep`.

#### 1.1.3.2 Specifying Additional Object Libraries

You can control the libraries as follows:

- To specify additional object library file names for `ld` to locate, use the `-lstring` flag to define an additional object library for `ld` to search. Thus, each occurrence of the `-lstring` flag specifies an additional file name that is added to the list of object libraries for `ld` to locate. The standard COBOL library file names searched (shown in the form of the appropriate `-lstring` flag) are:

```
-lcob
-lcurses
-lFutil
-lots2
-lots
-lisam
-lsort
-lexc
-lm
```

For instance, the file name of `-lcob` is `libcob`.

The following example specifies the additional library `libX`:

```
% cobol simtest.cob -lX
```

- In addition to the standard directories in which `ld` tries to locate the library file names, you can use the `-Ldir` flag to specify another directory. The `-lstring` flag and `-Ldir` flag respectively adds an object library file name (`-lstring`) or directory path (`-Ldir`) that `ld` uses to locate all specified library files. The standard `ld` directories are searched before directories specified by the `-Ldir` flag.

The following example specifies the additional object library path `/usr/lib/mytest`:

```
% cobol simtest.cob -L/usr/lib/mytest
```

- You can indicate that `ld` should not search its list of standard directories at all by specifying the `-L` flag. When you do so, you must specify all libraries on the `cobol` command line in some form, including the directory for `cobol` standard libraries. To specify all libraries, you might use the `-L` flag in combination with the `-Ldir` flag on the same `cobol` command line.

## Developing HP COBOL Programs

### 1.1 Developing Programs on Tru64 UNIX

- You can specify the pathname and file name of an object library as you would specify any file. Specifying each object library that resides in special directories in this manner is an alternative to specifying the library using the `-lstring` or `-Ldir` flag. This method can reduce the amount of searching the linker must do to locate all the needed object files.

In certain cases, you may need to specify the pathname and file name instead of using the `-lstring` or `-Ldir` flags for the linker to resolve global symbols with shared libraries.

When processing a C source file (`.c` suffix) using the `cobol` command, you may need to specify the appropriate C libraries using the `-lstring` flag.

#### 1.1.3.3 Specifying Types of Object Libraries

Certain `cobol` flags influence whether `ld` searches for an archive (`.a`) or shared object (`.so`) library on the standard list of COBOL libraries and any additional libraries specified using the `-lstring` or `-Ldir` flags. These flags are the following:

- The `-call_shared` flag, the default, indicates that `.so` files are searched before `.a` files. As `ld` attempts to resolve external symbols, it looks at the shared library first before the corresponding archive library. References to symbols found in a `.so` library are dynamically loaded into memory at run time. References to symbols found in `.a` libraries are loaded into the executable image file at link time. For instance, `/usr/shlib/libc.so` is searched before `/usr/lib/libc.a`.
- The `-non_shared` flag indicates that *only* `.a` files are searched, so the object module created contains static references to external routines and are loaded into the executable image at link time, not at run time. Corresponding `.so` files are not searched.

The following example requests that the standard `cobol .a` files be searched instead of the corresponding `.so` files:

```
% cobol -non_shared mainprog.cob rest.o
```

External references found in an archive library result in that routine being included in the resulting executable program file at link time.

External references found in a shared object library result in a special link to that library being included in the resulting executable program file, instead of the actual routine itself. When you run the program, this link gets resolved by either using the shared library in memory (if it already exists) or loading it into memory from disk.

#### 1.1.3.4 Creating Shared Object Libraries

To create a shared library, first create the `.o` file, such as `octagon.o` in the following example:

```
% cobol -03 -c octagon.cob
```

The file `octagon.o` is then used as input to the `ld` command to create the shared library, named `octagon.so`:

```
% ld -shared -no_archive octagon.o \  
-lcob -lcurses -lFutil -lots2 -lots -lisam -lsort -lexc -lmld -lm
```

A description of each `ld` flag follows:

- The `-shared` flag is required to create a shared library.

## Developing HP COBOL Programs

### 1.1 Developing Programs on Tru64 UNIX

- The `-no_archive` flag indicates that `ld` should not search archive libraries to resolve external names (only shared libraries).
- The name of the object module is `octagon.o`. You can specify multiple `.o` files.
- The `-lcob` and subsequent flags are the standard list of libraries that the COBOL command would have otherwise passed to `ld`. When you create a shared library, all symbols must be resolved. For more information about the standard list of libraries used by HP COBOL, see Section 1.1.3.2.

#### 1.1.3.5 Shared Library Restrictions

When creating a shared library using `ld`, be aware of the following restrictions:

- Programs that are installed `setuid` or `setgid` will not use any libraries that have been installed using the `inlib` shell command, but only systemwide shared libraries (for security reasons).
- For other restrictions imposed by the operating system, refer to your operating system documentation. If you create a shared library that contains routines written in C, refer to your operating system documentation for any restrictions associated with the `cc` command.

#### 1.1.3.6 Installing Shared Libraries

Once the shared library is created, it must be installed before you run a program that refers to it. The following describes how you can install a shared library for private or systemwide use:

- To install a private shared library, such as for testing, set the environment variable `LD_LIBRARY_PATH`, as described in `ld(1)`.
- To install a systemwide shared library, place the shared library file in one of the standard directory paths used by `ld` (see `ld(1)`).

For complete information on installing shared libraries, refer to your operating system documentation.

#### Specifying Shared Object Libraries

When you link your program with a shared library, all symbols must be referenced before `ld` searches the shared library, so you should always specify libraries at the end of the `cobol` command line after all file names. Unless you specify the `-non_shared` flag, shared libraries will be searched before the corresponding archive libraries.

For instance, the following command generates an error if the file `rest.o` references routines in the library `libX`:

```
% cobol -call_shared test.cob -lX rest.o
```

The correct order follows:

```
% cobol -call_shared test.cob rest.o -lX
```

Link errors can occur with symbols that are defined twice, as when both an archive and shared object are specified on the same command line. In general, specify any archive libraries after the last file name, followed by any shared libraries at the end of the command line.

Before you reference a shared library at run time, it must be installed.

## Developing HP COBOL Programs

### 1.1 Developing Programs on Tru64 UNIX

#### 1.1.3.7 Interpreting Messages from the Linker

If the linker detects any errors while linking object modules, it displays messages about their cause and severity. If any errors occur, the linker does not produce an image file.

Linker messages are descriptive, and you do not normally need additional information to determine the specific error. The general format for `ld` messages follows:

```
ld:  
message-text
```

The *message-text* may be on multiple lines and is sometimes accompanied by a cobol error.

Some common errors that occur during linking resemble the following:

- An object module has compilation errors. This error occurs when you attempt to link a module that had warnings or errors during compilation. Although you can usually link compiled modules for which the compiler generated messages, you should verify that the modules will actually produce the output you expect.
- The modules being linked define more than one transfer address. The linker generates a warning if more than one main program has been defined. This can occur, for example, when an extra `END` statement exists in the program. The image file created by the linker in this case can be run; the entry point to which control is transferred is the first one that the linker found.
- A reference to a symbol name remains unresolved. This error occurs when you omit required module or library names from the `cobol` or `ld` command and the linker cannot locate the definition for a specified global symbol reference.

If an error occurs when you link modules, you may be able to correct it by retyping the command string and specifying the correct routines or libraries (`-lstring` flag, `-Ldir` flag), or specify the object library or object modules on the command line.

#### 1.1.4 Running an HP COBOL Program on Tru64 UNIX

The simplest form of the run command to execute a program is to type its file name at the operating system prompt, as follows:

```
% myprog.out
```

In addition to normal IO accesses, your HP COBOL programs can read command-line arguments and access (read and write) environment variables.

##### 1.1.4.1 Accessing Command-Line Arguments

Command-line arguments allow you to provide information to a program at run time. Your program provides the logic to parse the command line, identify command-line options, and act upon them. For example, you might develop a program that will extract a given amount of data from a specified file, where both the number of records to read and the file name are highly dynamic, changing for each activation of your program. In this case your program would contain code that reads a command-line argument for the number of records to read, and a second argument for the file specification. Your program execution command could look like the following:

## Developing HP COBOL Programs

### 1.1 Developing Programs on Tru64 UNIX

```
% myprog 1028 powers.dat
```

In the preceding example the program myprog would read 1028 records from the file powers.dat.

Multiple command-line arguments are delimited by spaces, as shown in the preceding example. If an argument itself contains spaces, enclose that argument in quotation marks (" ") as follows:

```
% myprog2 "all of this is argument 1" argument2
```

You provide definitions for the command-line arguments with the SPECIAL-NAMES paragraph in your program's Environment Division, and you include ACCEPT and DISPLAY statements in the Procedure Division to parse the command line and access the arguments. Detailed information about command-line argument capability is in the ACCEPT and DISPLAY sections in the *HP COBOL Reference Manual*.

#### 1.1.4.2 Accessing Environment Variables

You can read and write environment variables at run time through your HP COBOL program.

Example 1-1 allows you to specify a file specification by putting the directory in the value of the environment variable COBOLPATH, and the file name in a command-line argument:

#### Example 1-1 Accessing Environment Variables and Command-Line Arguments

```
identification division.
PROGRAM-ID. MYPROG.
ENVIRONMENT DIVISION.
CONFIGURATION SECTION.
SPECIAL-NAMES.
    SYSERR             IS STANDARD-ERROR
    ENVIRONMENT-NAME  IS NAME-OF-ENVIRONMENT-VARIABLE
    ENVIRONMENT-VALUE IS ENVIRONMENT-VARIABLE
    ARGUMENT-NUMBER  IS POS-OF-COMMAND-LINE-ARGUMENT
    ARGUMENT-VALUE   IS COMMAND-LINE-ARGUMENT.

DATA DIVISION.
WORKING-STORAGE SECTION.
01 howmany-records PIC 9(5).
01 env-dir PIC x(50).
01 file-name PIC x(50).
01 file-spec PIC x(100).
PROCEDURE DIVISION.
BEGIN.
    ACCEPT howmany-records FROM COMMAND-LINE-ARGUMENT
    ON EXCEPTION
        DISPLAY "No arguments specified"
        UPON STANDARD-ERROR
        END-DISPLAY
    STOP RUN
END-ACCEPT.
```

(continued on next page)

# Developing HP COBOL Programs

## 1.1 Developing Programs on Tru64 UNIX

### Example 1–1 (Cont.) Accessing Environment Variables and Command-Line Arguments

```
DISPLAY "COBOLPATH" UPON NAME-OF-ENVIRONMENT-VARIABLE.  
ACCEPT env-dir FROM ENVIRONMENT-VARIABLE  
ON EXCEPTION  
    DISPLAY "Environment variable COBOLPATH is not set"  
    UPON STANDARD-ERROR  
END-DISPLAY  
NOT ON EXCEPTION  
    ACCEPT file-name FROM COMMAND-LINE-ARGUMENT  
    ON EXCEPTION  
        DISPLAY  
        "Attempt to read beyond end of command line"  
        UPON STANDARD-ERROR  
    END-DISPLAY  
    NOT ON EXCEPTION  
        STRING env-dir "/" file-name delimited by " " into file-spec  
        DISPLAY "Would have read " howmany-records " records from " file-spec  
    END-ACCEPT  
END-ACCEPT.
```

This example requires that the following command has been executed to set an environment variable:

```
% setenv COBOLPATH /usr/files
```

When you execute the following command lines:

```
% cobol -o myprog myprog.cob  
% myprog 1028 powers.dat
```

The following will result:

- howmany-records will contain “1028”
- env-dir will contain “/usr/files”
- file-name will contain “powers.dat”
- file-spec will contain “/usr/files/powers.dat”

For additional information, refer to the ACCEPT and DISPLAY statements in the *HP COBOL Reference Manual*.

#### 1.1.4.3 Errors and Switches

See Section 1.4 for a discussion of errors that can cause incorrect or undesirable results when you run a program.

See Section 1.5 for a discussion of controlling program execution with switches.

#### 1.1.5 Program Development Stages and Tools

This manual primarily addresses the program development activities associated with development and testing phases. For information about topics usually considered during application design, specification, and maintenance, refer to your operating system documentation, appropriate reference pages, or appropriate commercially published documentation.



## Developing HP COBOL Programs

### 1.1 Developing Programs on Tru64 UNIX

Table 1–3 lists and describes some of the software tools you can use when developing and testing a program.

**Table 1–3 Main Tools for Program Development and Testing**

Task or Activity	Tool and Description
Manage source files	Use RCS or sccs to manage source files. For more information, refer to the Tru64 UNIX documentation on programming support tools or the appropriate reference page.
Create and modify source files	Use a text editor, such as vi, emacs, or another editor. For more information, refer to your operating system documentation.
Analyze source code	Use searching commands such as grep and diff. For more information, refer to the Tru64 UNIX documentation on programming support tools or the appropriate reference page.
Build program (compile and link)	You can use the cobol command to create small programs, perhaps using shell scripts, or use the make command to build your application in an automated fashion using a <b>makefile</b> . For more information on make, refer to the make(1) reference page and the Tru64 UNIX documentation on programming support tools.
Debug and test program	Use the Ladebug Debugger to debug your program or run it for general testing. For more information on Ladebug Debugger, refer to the <i>Ladebug Debugger Manual</i> .
Install program	Use setld and related commands such as tar. For more information, refer to the Tru64 UNIX documentation on programming support tools.

In addition, you might use the following shell commands at various times during program development:

- To view information about an object file or an object library, use the following commands:
  - The file command shows the type of a file (such as which programming language, whether it is an object library, ASCII file, and so forth).
  - The nm command (perhaps with the -a or -o flag) shows symbol table information, including the identification field of each object file.
  - The odump command shows the contents of a file and other information.
  - The size command shows the size of the code and data sections.For more information on these commands, refer to the appropriate reference page or the Tru64 UNIX documentation on programming support tools.
- Use the ar command to create an archive object library (-r flag), maintain the modules in the library, list the modules in the library (-t), and perform other functions. Use -ts to add a table of contents to the object library for linking purposes. For more information, refer to ar(1) or the Tru64 UNIX programmer's documentation.
- To create shared libraries on Tru64 UNIX systems, use ld, not the ar command. For more information, see Section 1.1.3.4 and refer to the Tru64 UNIX programmer's documentation.

## Developing HP COBOL Programs

### 1.1 Developing Programs on Tru64 UNIX

- The `strip` command removes symbolic and other debugging information to minimize image size. For additional information, refer to the `strip(1)` reference page.

---

#### Note

---

The `CALL dataname`, `CANCEL`, and the Hewlett-Packard extensions to the `ACCEPT` and `DISPLAY` statements will not work correctly if you use the `strip` command on your image.

---

In most instances, use the `cobol` command to invoke both the HP COBOL compiler and the `ld` linker. To link one or more object files created by the HP COBOL compiler, you should use the `cobol` command instead of the `ld` command, because the `cobol` command automatically references the appropriate HP COBOL Run-Time Libraries when it invokes `ld`. If the executable image is not in your current working directory, specify the directory path in addition to the file name.

Compilation does the following for you:

- Detects errors in your program syntax
- Displays compiler messages on your terminal screen
- Generates machine language instructions from valid source statements
- Groups the instructions into an object module for the linker
- Launches the linker with the compiled file or files
- Creates an executable image

You use the `cobol` command to compile and link your program. The `cobol` command invokes the HP COBOL compiler driver that is the actual user interface to the HP COBOL compiler. The compiler driver can accept command options and multiple file names, and normally causes the compiler and linker to process each file. A variety of qualifiers to the `compile` command are available to specify optional processing and to specify the names of output files.

After the HP COBOL compiler processes the source files to create one or more object files, the compiler driver passes a list of object files and other information to the linker. ♦

## 1.2 Developing Programs on OpenVMS

You use DCL commands (commands used at the OpenVMS system prompt) to create, compile, link, and run HP COBOL programs on OpenVMS systems.

### 1.2.1 Creating an HP COBOL Program on OpenVMS

To create and modify an HP COBOL program, you must invoke a text editor. The default editor for OpenVMS is the Text Processing Utility (TPU). Other editors, such as EDT or the Language-Sensitive Editor (LSE), may be available on your system. Check with your system administrator and refer to the *OpenVMS EDT Reference Manual* (this manual has been archived but is available on the OpenVMS Documentation CD-ROM) for more information about EDT or the *Guide to Language-Sensitive Editor* for additional information about LSE.

## Developing HP COBOL Programs 1.2 Developing Programs on OpenVMS

**Figure 1–2 DCL Commands for Developing Programs**

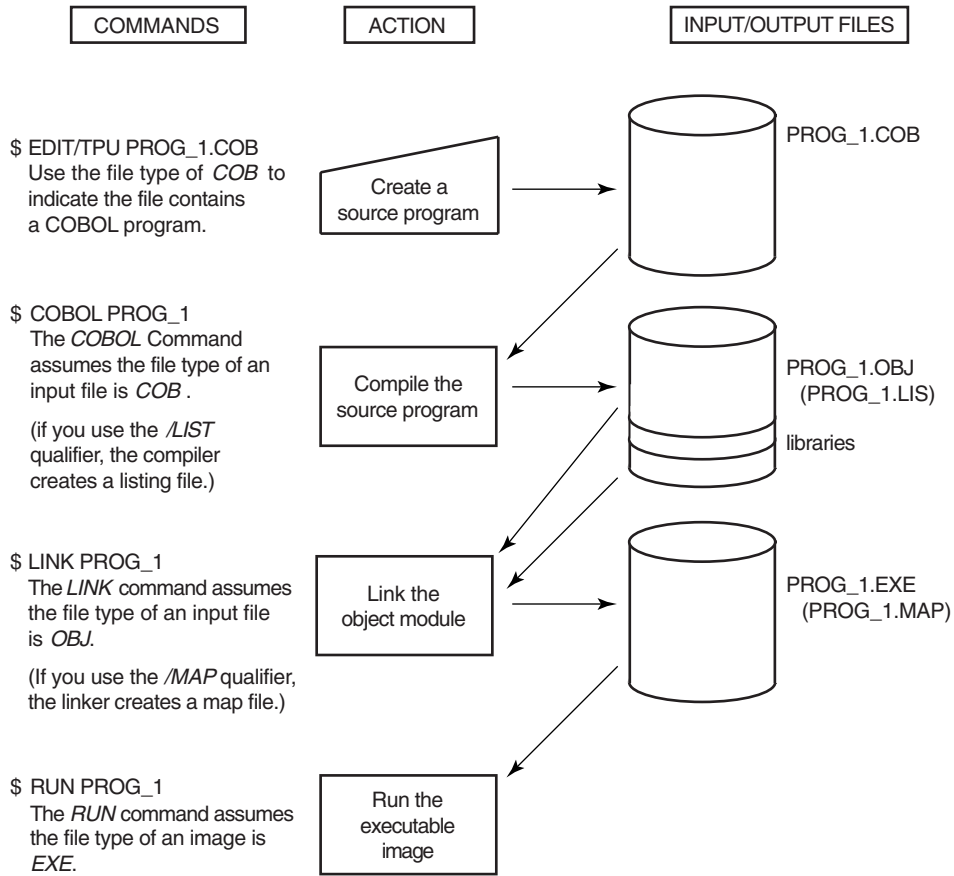

VM-0611A-AI

Figure 1–2 shows the basic steps in HP COBOL program development.

Use the text editor of your preference to create and revise your source files. For example, the following command line invokes the TPU editor and creates the source file `PROG_1.COB`:

```
$ EDIT PROG_1.COB
```

The file type `.COB` is used to indicate that you are creating an HP COBOL program. `COB` is the default file type for all HP COBOL programs.

### The COPY Statement, Dictionaries, and Libraries

Including the `COPY` statement in your program allows separate programs to share common source text, reducing development and testing time as well as storage requirements. You can use the `COPY` statement to access modules in libraries. The `COPY` statement causes the compiler to read the file or module specified during the compilation of a program. When the compiler reaches the end of the included text, it resumes reading from the previous input file.

By using the `/INCLUDE` qualifier on the COBOL command line, you can set up a search list for files specified by the `COPY` statement. For more information, refer to the *HP COBOL Reference Manual*.

## Developing HP COBOL Programs

### 1.2 Developing Programs on OpenVMS

You can use the COPY FROM DICTIONARY statement in your program to access a data dictionary and copy Oracle CDD/Repository record descriptions into your program as COBOL record descriptions. Before you can copy record descriptions from Oracle CDD/Repository, you must create the record descriptions using the Common Data Dictionary Language (CDDL) or Common Dictionary Operator (CDO).

For more information about using Oracle CDD/Repository and creating and maintaining text libraries, refer to the *HP COBOL Reference Manual* and *Using Oracle CDD/Repository on OpenVMS Systems*.

#### 1.2.2 Compiling an HP COBOL Program on OpenVMS

To compile your program, use the COBOL command. The HP COBOL compiler performs these primary functions:

- Detects errors in your program.
- Displays each compiler message on your terminal screen.
- Generates machine language instructions from valid source statements.
- Groups these language instructions into an object module for the linker.
- Creates an analysis file if you request it with the /ANALYSIS\_DATA qualifier. SCA uses this file to display information about program symbols and source files.

The compiler outputs an object module that provides the following information:

- The name of the entry point. It takes this name from the program name in the first PROGRAM-ID paragraph in the program.
- A list of variables that are declared in the module. The linker uses this information when it binds two or more modules together and must resolve references to the same names in the modules.
- Traceback information. This information is used by the system default condition handler when an error occurs that is not handled by the program. The traceback information permits the default handler to display a list of the active blocks in the order of activation; this is an aid in program debugging.
- A symbol table and a source line correlation table, only if you request them with the /DEBUG qualifier. A symbol table is a list of the names of all external and internal variables within a module, with definitions of their locations. The source line correlation table associates lines in your source file with lines in your program. These tables are of primary help when you use the OpenVMS Debugger.

To invoke the HP COBOL compiler, use the COBOL command (explained in Section 1.2.2.1). You can specify qualifiers with the COBOL command. The following sections discuss the COBOL command and its qualifiers.

##### 1.2.2.1 Format of the COBOL Command on OpenVMS

The COBOL command has the following format:

```
COBOL [/qualifier] ... {file-spec [/qualifier] ...} ...
```

**/qualifier**

Specifies an action to be performed by the compiler on all files or specific files listed. When a qualifier appears directly after the COBOL command, it affects all the files listed. By contrast, when a qualifier appears after a file specification, it affects only the file that immediately precedes it. However, when files are concatenated, these rules do not apply.

**file-spec**

Specifies an input source file that contains the program or module to be compiled. You are not required to specify a file type; the HP COBOL compiler assumes the default file type COB. If you do not provide a file specification with the COBOL command, the system prompts you for one.

**1.2.2.2 Compiling Multiple Files**

You can include more than one file specification on the same command line by separating the file specifications with either a comma (,) or a plus sign (+). If you separate the file specifications with commas, you can control which source files are affected by each qualifier. In the following example, the HP COBOL compiler creates an object file for each source file but creates only a listing file for the source files entitled PROG\_1 and PROG\_3:

```
$ COBOL/LIST PROG_1, PROG_2/NOLIST, PROG_3
```

If you separate file specifications with plus signs, the HP COBOL compiler concatenates each of the specified source files and creates one object file and one listing file. In the following example, only one object file, PROG\_1.OBJ, and one listing file, PROG\_1.LIS, are created. Both of these files are named after the first source file in the list, but contain all three modules.

```
$ COBOL PROG_1 + PROG_2/LIST + PROG_3
```

Any qualifiers specified for a single file within a list of files separated with plus signs affect all files in the list.

**1.2.2.3 Debugging a Program**

To effectively debug an HP COBOL program, you must first make symbol and traceback information available by adding the DEBUG option to the compile command line. You specify the /DEBUG option as follows:

```
$ COBOL/DEBUG myprog  
$ LINK/DEBUG myprog  
$ RUN/DEBUG myprog
```

This enables you to examine and modify variables, monitor flow of control, and perform various other debugging techniques. See Section C.3 or type HELP COBOL/DEBUG or HELP DEBUG for additional information.

On Alpha and I64, when you compile a program with /DEBUG, you should also specify /NOOPTIMIZE to expedite your debugging session. (The default is /OPTIMIZE.) Optimization often changes the order of execution of the object code generated for statements in a program, and it might keep values in registers and deallocate user variables. These effects can be confusing when you use the debugger. (A diagnostic message warns you if you compile an HP COBOL program with /DEBUG without specifying anything about optimization on the command line.)

## Developing HP COBOL Programs

### 1.2 Developing Programs on OpenVMS

Pay attention to compiler messages. Informational and warning messages (as well as error-level messages) do not prevent the production of an object file, which you can link and execute. However, the messages sometimes point out otherwise undetected logic errors, and the structure of the program might not be what you intended.

#### 1.2.2.4 Separately Compiled Programs (Alpha, I64)

If a compilation unit consists of multiple separately compiled programs (SCPs), by default the HP COBOL compiler produces a single object file that consists of a single module with multiple embedded procedures. This object file can be inserted into an object library. If your build procedure requires that the linker extract any part of the module, the linker must extract the entire object.

If you use `/SEPARATE_COMPILATION` on the compile command line, HP COBOL will compile multiple SCPs into a single object file that consists of a concatenation of modules, each containing a single procedure. This object may then be inserted into an object library from which the linker can extract just the procedures that are specifically needed. ♦

#### 1.2.2.5 COBOL Qualifiers

COBOL options (also known as qualifiers or flags) control the way in which the compiler processes a file. You can process your file with the COBOL command alone or you can select options that offer you alternatives for developing, debugging, and documenting programs.

If you compile parts of your program (compilation units) using multiple COBOL commands, options that affect the execution of the program should be used consistently for all compilations, especially if data will be shared or passed between procedures.

Table 1–4 lists the COBOL command options and their defaults. For more information about COBOL options, invoke online help for COBOL at the system prompt.

---

#### Note

---

Brackets ([]) indicate that the enclosed item is optional. If you specify more than one option for a single qualifier, you must separate each option with a comma and enclose the list of options in parentheses.

---

**Table 1–4 COBOL Command Qualifiers**

Qualifier	Default	Alpha, 164 Only	VAX Only
/ALIGNMENT[=[NO]PADDING] or /NOALIGNMENT	/NOALIGNMENT	X	
/ANALYSIS_DATA[=file-spec] or /NOANALYSIS_DATA	/NOANALYSIS_DATA		
/ANSI_FORMAT or /NOANSI_FORMAT	/NOANSI_FORMAT		
/ARCHITECTURE= { GENERIC HOST EV4 EV5 EV56 EV6 EV67, EV68 PCA56 }	/ARCHITECTURE=GENERIC	X	
/ARITHMETIC= { STANDARD NATIVE }	/ARITHMETIC=NATIVE	X	
/AUDIT or /NOAUDIT	/NOAUDIT		X
/CHECK= [ [NO]PERFORM [NO]BOUNDS [NO]DECIMAL (Alpha only) [NO]DUPLICATES ALL <sup>1</sup> NONE ] ] or /NOCHECK	/NOCHECK or /CHECK=NONE		
/CONDITIONALS=(character,...) or /NOCONDITIONALS	/NOCONDITIONALS		
/CONVERT=[NO]LEADING_BLANKS or /NOCONVERT	/NOCONVERT	X	
/COPY_LIST or /NOCOPY_LIST	/NOCOPY_LIST		
/CROSS_REFERENCE= [ ALPHABETICAL <sup>1</sup> DECLARED ] or /NOCROSS_REFERENCE	/NOCROSS_REFERENCE		

<sup>1</sup>This is the default keyword when using the named option with no keywords.

(continued on next page)

# Developing HP COBOL Programs

## 1.2 Developing Programs on OpenVMS

**Table 1–4 (Cont.) COBOL Command Qualifiers**

Qualifier	Default	Alpha, I64 Only	VAX Only
/DEBUG= [ [NO]SYMBOLS [NO]TRACEBACK ALL NONE ] ,... or /NODEBUG	/DEBUG=TRACEBACK /DEBUG=ALL <sup>1</sup> /DEBUG=(TRACEBACK,SYMBOLS) <sup>1</sup>		
/DEPENDENCY_DATA or /NODEPENDENCY_DATA	/NODEPENDENCY_DATA		
/DESIGN or /NODESIGN	/NODESIGN		X
/DIAGNOSTICS[=file-spec] or /NODIAGNOSTICS	/NODIAGNOSTICS		
/DISPLAY_FORMATTED or /NODISPLAY_FORMATTED	/NODISPLAY_FORMATTED	X	
/FIPS=74 or /NOFIPS	/NOFIPS		
/FLAGGER= [ HIGH_FIPS <sup>1</sup> INTERMEDIATE_FIPS MINIMUM_FIPS OBSOLETE OPTIONAL_FIPS REPORT_WRITER SEGMENTATION SEGMENTATION_1 ] ,... or /NOFLAGGER	/NOFLAGGER		
/FLOAT= [ D_FLOAT G_FLOAT IEEE_FLOAT ]	/FLOAT=D_FLOAT	X	
/GRANULARITY= [ BYTE LONGWORD QUADWORD ]	/GRANULARITY=QUADWORD	X	
/INCLUDE=file-spec or /NOINCLUDE	/NOINCLUDE	X	
/INSTRUCTION_SET or /NOINSTRUCTION_SET	/INSTRUCTION_SET=DECIMAL_ STRING		X

<sup>1</sup>This is the default keyword when using the named option with no keywords.

(continued on next page)



## Developing HP COBOL Programs 1.2 Developing Programs on OpenVMS

**Table 1–4 (Cont.) COBOL Command Qualifiers**

Qualifier	Default	Alpha, I64 Only	VAX Only
/KEEP or /NOKEEP	/NOKEEP		
/LIST[=filename.ext] or /NOLIST	/NOLIST /LIST (batch)		
/MACHINE_CODE or /NOMACHINE_CODE	/NOMACHINE_CODE		
/MAP= [ ALPHABETICAL <sup>1</sup> DECLARED ] ,... or /NOMAP	/NOMAP		
/MATH_INTERMEDIATE= { CIT3 CIT4 FLOAT }	/MATH_INTERMEDIATE=FLOAT	X	
/NAMES= { AS_IS LOWER LOWERCASE UPPER UPPERCASE }	/NAMES=LOWERCASE	X	
/NATIONALITY= [ JAPAN US ]	/NATIONALITY=US	X	
/OBJECT[=filename.ext] or /NOOBJECT	/OBJECT		

<sup>1</sup>This is the default keyword when using the named option with no keywords.

(continued on next page)

# Developing HP COBOL Programs

## 1.2 Developing Programs on OpenVMS

**Table 1–4 (Cont.) COBOL Command Qualifiers**

Qualifier	Default	Alpha, 164 Only	VAX Only
/OPTIMIZE= { LEVEL= { 0 <sup>2</sup> 1 2 3 4 <sup>1</sup> } TUNE= { GENERIC <sup>1</sup> HOST EV4 EV5 EV56 EV6 EV67, EV68 PCA56 } } ]	/OPTIMIZE= (LEVEL=4,TUNE=GENERIC)	X	
or /NOOPTIMIZE			
/RESERVED_WORDS= [ [NO]200X [NO]XOPEN [NO]FOREIGN_EXTENSIONS ] , ...	/RESERVED_WORDS=(XOPEN, NO200X, NOFOREIGN_EXTENSIONS)	X	
/SEPARATE_COMPILATION or /NOSEPARATE_COMPILATION	/NOSEPARATE_COMPILATION	X	
/SEQUENCE_CHECK or /NOSEQUENCE_CHECK	/NOSEQUENCE_CHECK		
/SOURCE[=filename.ext]	Source is filename.COB	X	
/STANDARD= [ 85 [NO]MIA [NO]SYNTAX [NO]V3 [NO]XOPEN (Alpha) ] , ...	/STANDARD=85 <sup>1</sup>		
or /NOSTANDARD			
/TIE or /NOTIE	/NOTIE	X	
/TRUNCATE or /NOTRUNCATE	/NOTRUNCATE		
/VFC or /NOVFC	/VFC	X	

<sup>1</sup>This is the default keyword when using the named option with no keywords.

<sup>2</sup>/OPTIMIZE=0 is functionally equivalent to /NOOPTIMIZE.

(continued on next page)

**Table 1–4 (Cont.) COBOL Command Qualifiers**

Qualifier	Default	Alpha, I64 Only	VAX Only
/WARNINGS= [ [NO]INFORMATION [NO]OTHER ALL <sup>1</sup> NONE ] ... or /NOWARNINGS	/WARNINGS=OTHER		

<sup>1</sup>This is the default keyword when using the named option with no keywords.

### 1.2.2.6 Common Command-Line Errors to Avoid

The following are some common errors to avoid when entering COBOL command lines:

- Omitting /ANSI\_FORMAT for programs that are in ANSI format (AREA A, AREA B, and so forth)
- Including contradictory options
- Omitting a necessary qualifier, such as /LIST if you specify /MAP
- Omitting version numbers from file specifications when you want to compile a program that is not the latest version of a source file
- Forgetting to use a file suffix in the file specification, or not specifying /SOURCE when your source file suffix is not .COB or .CBL

### 1.2.2.7 Compiling Programs with Conditional Compilation

To debug source code that contains conditional compilation lines, you can use either the /CONDITIONALS qualifier or the WITH DEBUGGING MODE clause. The /CONDITIONALS qualifier is listed in Table 1–4. For more information about the /CONDITIONALS qualifier, invoke the online help facility for HP COBOL at the system prompt. For more information about the WITH DEBUGGING MODE clause, refer to the *HP COBOL Reference Manual*.

Using the WITH DEBUGGING MODE clause as part of the SOURCE-COMPUTER paragraph causes the compiler to process all conditional compilation lines in your program as COBOL text. If you do not specify the WITH DEBUGGING MODE clause, and if the /CONDITIONALS qualifier is not in effect, all conditional compilation lines in your program are treated as comments.

The WITH DEBUGGING MODE clause applies to: (1) the program that specifies it, and (2) any contained program within a program that specifies the clause.

### 1.2.2.8 Interpreting Messages from the Compiler

If there are errors in your source file when you compile your program, the HP COBOL compiler flags these errors and displays helpful messages. You can reference the message, locate the error, and, if necessary, correct the error in your program.

On Alpha and I64, the general format of compiler messages shown on your screen is as follows:

# Developing HP COBOL Programs

## 1.2 Developing Programs on OpenVMS

.....^  
%COBOL-s-ident, message-text

At line number *n* in *name* ♦

On VAX, the general format of compiler messages is as follows:

%COBOL-s-ERROR *nnn*, (*m*) message-text

♦

### %COBOL

The facility or program name of the HP COBOL compiler. This prefix indicates that the HP COBOL compiler issued the message.

### s

The severity of the error, represented in the following way:

- F Fatal error. The compiler does not produce an object module. You must correct the error before you can compile the program to produce an object module.
- E Error. The compiler makes an assumption about what you intended and continues. However, the compiler's assumption may not relate to your intention. Correct the error.
- W Warning. The compiler attempts to correct the error in the statement, but you should verify that the compiler's action is acceptable. Otherwise, your program may produce unexpected results.
- I Informational. This message usually appears with other messages to inform you of specific actions taken by the compiler. No action is necessary on your part. Note that these messages are suppressed by default. You must invoke /WARN=ALL or /WARN=INFO to enable them.

### ident (Alpha, I64)

The message identification. This is a descriptive abbreviation of the message text.

♦

### nnn (VAX)

The message identification number.

### m (VAX)

The message pointer number. ♦

### message-text

The compiler's message. In many cases, it consists of no more than one line of output. A message generally provides you with enough information to determine the cause of the error so that you can correct it.

### At line number *n* in *name* (Alpha, I64)

The integer *n* is the number of the line where the diagnostic occurs. The number is relative to the beginning of the file or text library module specified by *name*.

On Alpha and I64, a sample compiler message with two diagnostics looks like this in the listing file:

```
12          PROCEDURE DIVISION.  
13          P-NAME  
14          MOVE ABC TO XYZ.  
.....^  
%COBOL-E-NODOT, Missing period is assumed
```

## Developing HP COBOL Programs

### 1.2 Developing Programs on OpenVMS

```
14             MOVE ABC TO XYZ.  
.....^  
%COBOL-F-UNDEFSYM, Undefined name
```

In the sample, the first diagnostic pointer (^) points to the MOVE statement in source line number 14, which is the closest approximation to where the error (P-NAME is not followed by a period) occurred. The second diagnostic pointer points to XYZ, an undefined name in source line number 14. Each diagnostic pointer is followed by a message line that identifies, in this order:

- The HP COBOL compiler generated the message
- The severity code of the message
- The message identification (a mnemonic of the message text)
- The text of the message

Although most compiler messages are self-explanatory, some require additional explanation. The online help facility for HP COBOL contains a list and descriptions of these HP COBOL compiler messages. Use the HELP COBOL Compiler Messages command to access this list. ♦

On OpenVMS VAX, diagnostic messages look like this example:

```
12             PROCEDURE DIVISION.  
13             P-NAME  
14             MOVE ABC TO XYZ.  
                1             2  
%COBOL-E-ERROR 65, (1) Missing period is assumed  
%COBOL-F-ERROR 349, (2) Undefined name
```

Here, error pointer (1) points to the approximate place where the error occurred (P-NAME has no period). Error pointer (2) points to an undefined name in source line number 14. The two error pointers are followed by two error message lines that each identify, in this order:

- That the COBOL compiler generated the error message
- The severity code: Fatal (F), Error (E), Warning (W), or Informational (I)
- The error message number
- The error pointers
- The error message ♦

To examine messages that occurred during compilation, you can search for each occurrence of %COBOL in the compiler listing file. Section 1.2.2.9 describes listing files.

#### 1.2.2.9 Using Compiler Listing Files

A **compiler listing file** provides information that can help you debug or document your HP COBOL program. It consists of the following sections:

- Program listing  
The program listing section contains the source code plus line numbers generated by the compiler. Any diagnostics will appear in this section.
- Storage map  
The storage map section is optional (produced by the /MAP qualifier); it contains summary information on program sections, variables, and arrays.
- Compilation summary

## Developing HP COBOL Programs

### 1.2 Developing Programs on OpenVMS

The compilation summary section lists the qualifiers used with the COBOL command and the compilation statistics.

- Machine code

The machine code section is optional; it displays compiler-generated object code.

To generate a listing file, specify the /LIST qualifier when you compile your HP COBOL program interactively as in the following example for PROG\_1.COB:

```
$ COBOL/LIST PROG_1.COB
```

If you compile your program as a batch job, the compiler creates a listing file by default. You can specify the /NOLIST qualifier to suppress creation of the listing file, if that suits your purposes. (In either case, however, the listing file is not automatically printed.) By default, the name of the listing file is the name of your source file followed by the file type .LIS. You can include a file specification with the /LIST qualifier to override this default.

When used with the /LIST qualifier, the following COBOL command qualifiers supply additional information in the compiler listing file:

- /COPY\_LIST—Includes source statements specified by the COPY command.
- /CROSS\_REFERENCE—Creates a cross-reference listing of user-defined names and references.
- /MACHINE\_CODE—Includes a list of compiler-generated machine code.
- /MAP—Produces maps, data names, procedure names, file names, and external references.

For a description of each qualifier's function, invoke the online help facility for COBOL at the system prompt as follows:

```
$ HELP COBOL
```

#### Compiler Listing File for a Contained Program

A contained COBOL program listing file includes two additional program elements that provide nesting level information about the main program and the contained program. For additional information about contained programs, see Chapter 12, Interprogram Communication.

### 1.2.3 Linking an HP COBOL Program

After you compile an HP COBOL source program or module, use the LINK command to combine your object modules into one executable image that the OpenVMS system can execute. A source program or module cannot run until it is linked.

When you execute the LINK command, the OpenVMS Linker performs the following functions:

- Resolves local and global symbolic references in the object code
- Assigns values to the global symbolic references
- Signals an error message for any unresolved symbolic reference
- Allocates virtual memory space for the executable image

The LINK command produces an executable image by default. However, you can specify qualifiers and qualifier options with the LINK command to obtain shareable images and system images.

See Table 1–5 for a list of commonly used LINK command qualifiers. For a complete list and for more information about the LINK qualifiers, invoke the online help facility for the LINK command at the system prompt.

For a complete discussion of linker capabilities and for detailed descriptions of LINK qualifiers and qualifier options, refer to the *OpenVMS Linker Utility Manual*.

### 1.2.3.1 The LINK Command

The format of the LINK command is as follows:

```
LINK[/qualifier] ... {file-spec[/qualifier] ...} ...
```

#### **/qualifier...**

Specifies output file options when it is positioned after the LINK command. Specifies input file options when it is positioned after *file-spec*.

#### **file-spec...**

Specifies the input files to be linked.

If you specify more than one input file, you must separate the input file specifications with a plus sign (+) or a comma (,).

By default, the linker creates an output file with the name of the first input file specified and the file type EXE. If you link multiple files, specify the file containing the main program first. Then the name of your output file will have the same name as your main program module.

The following command line links the object files MAINPROG.OBJ, SUBPROG1.OBJ, and SUBPROG2.OBJ to produce one executable image called MAINPROG.EXE:

```
$ LINK MAINPROG, SUBPROG1, SUBPROG2
```

### 1.2.3.2 LINK Qualifiers

LINK qualifiers allow you to control various aspects of the link operation such as modifying linker input and output and invoking the debugging and traceback facilities.

Table 1–5 summarizes some of the more commonly used LINK qualifiers. Refer to the *OpenVMS Linker Utility Manual* for a complete list and explanations of the LINK qualifiers or invoke the online help facility for the LINK command at the OpenVMS prompt.

---

**Note**

---

Brackets ([]) indicate that the enclosed item is optional. If you specify more than one option for a single qualifier, you must separate each option with a comma and enclose the list of options in parentheses.

---

# Developing HP COBOL Programs

## 1.2 Developing Programs on OpenVMS

**Table 1–5 Commonly Used LINK Qualifiers**

Function	Qualifier	Default
Indicate that an input file is a library file.	/LIBRARY	Not applicable.
Indicate that an input file is a linker options file.	/OPTIONS	Not applicable.
Request output file, define a file specification, and specify whether the image is shareable.	/EXECUTABLE[=file-spec] /SHAREABLE[=file-spec]	/EXECUTABLE= name.EXE  where <i>name</i> is the name of the first input file. /NOSHAREABLE
Request and specify the contents of an image map (memory allocation) listing.	/BRIEF /[NO]CROSS_REFERENCE /FULL /MAP[=file-spec] or /NOMAP	/NOCROSS_REFERENCE /NOMAP (interactive) /MAP=name.MAP (batch)  where <i>name</i> is the name of the first input file.
Specify the amount of debugging information.	/DEBUG[=file-spec] or /NODEBUG /[NO]TRACEBACK	/NODEBUG /TRACEBACK

### 1.2.3.3 Specifying Modules Other than HP COBOL Modules

When you link HP COBOL modules with other modules, your application will not work correctly if a non HP COBOL module contains a LIB\$INITIALIZE routine that:

1. Is invoked before the HP COBOL LIB\$INITIALIZE routine (COB\_NAME\_START) and
2. Calls an HP COBOL program that contains CALL by data name, extended ACCEPT, or extended DISPLAY statements.

HP COBOL uses the LIB\$INITIALIZE routine, COB\_NAME\_START, to initialize the run-time environment for the CALL by data name and extended ACCEPT and DISPLAY statements. Therefore, the COB\_NAME\_START routine must be invoked before any CALL, ACCEPT, or DISPLAY statements are performed.

The order in which LIB\$INITIALIZE routines are invoked is determined during the link and is shown in the image map. To ensure that the HP COBOL LIB\$INITIALIZE routine is invoked first, change your link command to the following:

```
$ LINK/EXE=name SYSSHARE:STARLET/INCL=COB_NAME_START,your_modules...
```

See Appendix B for information on a problem with LIB\$INITIALIZE when you call a C program.



### 1.2.3.4 Specifying Object Module Libraries

Linking against object modules allows your program to access data and routines outside of your compilation units. You can create your own object module libraries or they can be supplied by the system.

#### User-Created Object Module Libraries

You can make program modules accessible to other programmers by storing them in **object module libraries**. To link modules contained in an object module library, use the `/INCLUDE` qualifier with the `LINK` command<sup>2</sup> and specify the modules you want to link. The following example links the subprogram modules `EGGPLANT`, `TOMATO`, `BROCCOLI`, and `ONION` (contained in the `VEGETABLES` library) with the main program module `GARDEN`:

```
$ LINK GARDEN, VEGETABLES/INCLUDE=(EGGPLANT,TOMATO,BROCCOLI,ONION)
```

An object module library also contains a **symbol table** with the names of the global symbols in the library, and the names of the modules in which the symbols are defined. You specify the name of the object module library containing these symbol definitions with the `/LIBRARY` qualifier. When you use the `/LIBRARY` qualifier during a linking operation, the linker searches the specified library for all unresolved references found in the included modules during compilation.

The following example uses the library `RACQUETS` to resolve undefined symbols in the `BADMINTON`, `TENNIS`, and `RACQUETBALL` libraries:

```
$ LINK BADMINTON, TENNIS, RACQUETBALL, RACQUETS/LIBRARY
```

For more information about the `/INCLUDE` and `/LIBRARY` qualifiers, invoke the online help facility for the `LINK` command at the `DCL` prompt or refer to the *OpenVMS Linker Utility Manual*.

You can define one or more of your private object module libraries as default user libraries. The following section describes how to accomplish this using the `DEFINE` command.

#### Defining Default User Object Module Libraries

You can define one or more of your private object module libraries as your **default user libraries** using the `DCL` `DEFINE` command, as in the following example:

```
$ DEFINE LNK$LIBRARY DEFLIB
```

The linker searches default user libraries for unresolved references after it searches modules and libraries specified in the `LINK` command.

In this example, `LNK$LIBRARY` is a logical name and `DEFLIB` is the name of an object module library (having the file type `OLB`) that you want the linker to search automatically in all subsequent link operations.

You can establish any object module library as a default user library by creating a logical name for the library. The logical names you must use are `LNK$LIBRARY` (as in the preceding example), `LNK$LIBRARY_1`, `LNK$LIBRARY_2`, and so on, to `LNK$LIBRARY_999`. When more than one of these logical names exists when a `LINK` command executes, the linker searches them in numeric order beginning with `LNK$LIBRARY`.

---

<sup>2</sup> The `/INCLUDE` qualifier on the `LINK` command is not to be confused with the `/INCLUDE` qualifier on the `COBOL` compile command, which specifies a search list for `COPY` files.

## Developing HP COBOL Programs

### 1.2 Developing Programs on OpenVMS

When one or more logical names exist for default user libraries, the linker uses the following search order to resolve references:

- The process, group, and system logical name tables (in that order) are searched for the name LNK\$LIBRARY. If the logical name exists in any of these tables and if it contains the desired reference, the search is ended.
- The process, group, and system logical name tables (in that order) are searched for the name LNK\$LIBRARY\_1. If the logical name exists in any of these tables, and if it contains the desired reference, the search is ended.

This search sequence occurs for each reference that remains unresolved.

#### System-Supplied Object Module Libraries

All HP COBOL programs reference **system-supplied object module libraries** when they are linked. These libraries contain routines that provide I/O and other system functions. Additionally, you can use your own libraries to provide application-specific object modules.

To use the contents of an object module library, you must do the following:

- Refer to a symbol in the object module by name in your program in a CALL statement or VALUE EXTERNAL reference.
- Make sure that the linker can locate the library that contains the object module by ensuring that required software is correctly installed.
- Make sure that your default directory (or LINK/EXE directory) is valid and that you have write privileges to it.

To specify that a linker input file is a library file, use the /LIBRARY qualifier. This qualifier causes the linker to search for a file with the name you specify and the default file type .OLB. If you specify a file that the linker cannot locate, a fatal error occurs and linking terminates.

The sections that follow describe the order in which the linker searches libraries that you specify explicitly, default user libraries, and system libraries.

For more information about object module libraries, refer to the *OpenVMS Linker Utility Manual*.

#### Defining the Search Order for Libraries

When you specify libraries as input for the linker, you can specify as many as you want; there is no practical limit. More than one library can contain a definition for the same module name. The linker uses the following conventions to search libraries specified in the command string:

- A library is searched only for definitions that are unresolved in the previously specified input files.
- If you specified more than one object module library, the libraries are searched in the order in which they are specified.

For example:

```
$ LINK METRIC,DEFLIB/LIBRARY,APPLIC
```

The library DEFLIB will be searched only for unresolved references in the object module METRIC. It is not searched to resolve references in the object module APPLIC. However, this command can also be entered as follows:

```
$ LINK METRIC,APPLIC,DEFLIB/LIBRARY
```

In this case, DEFLIB.OLB is searched for all references that are not resolved between METRIC and APPLIC. After the linker has searched all libraries specified in the command, it searches default user libraries, if any, and then the default system libraries.

### 1.2.3.5 Creating Shareable Images

You can create HP COBOL subprograms as shareable images by using the LINK qualifier /SHARE. A **shareable image** is a single copy of a subprogram that can be shared by many users or applications. Using shareable images provides the following benefits:

- Saves system resources, since one physical copy of a set of procedures can be shared by more than one application or user
- Facilitates the linking of very large applications by allowing you to break down the whole application into manageable segments
- Allows you to modify one or more sections of a large application without having to relink the entire program

The following steps describe one way to create an HP COBOL subprogram as a shareable image:

1. Create the main program used to call the subprogram.
2. Create the subprogram.
3. Link the subprogram as a shareable image by using the /SHARE qualifier and including the options file containing the symbol vector in the LINK command as an input file. (See the sections Using Symbol Vectors with Shareable Images (Alpha, I64) and Using Transfer Vectors (VAX) for information about vectors.)
4. Define a logical name to point to your shareable image.
5. Install the shareable image subprogram, using the OpenVMS Install utility (INSTALL).
6. Link the main program with the shareable image.

Once you have completed these steps, you can run the main program to access the subprogram installed as a shareable image.

Refer to the *OpenVMS Linker Utility Manual* and the *Guide to Creating OpenVMS Modular Procedures* for more information about shareable images.

The following sample programs and command procedures provide an example of how to create and link a subprogram as a shareable image, as described in the preceding steps.

---

**Note**

---

Do not use the /SHARE qualifier when you link a main program. Creating a main program as a shareable image is unsupported.

---

Example 1–2 shows the main program CALLER.COB and the two subprograms (SUBSHR1.COB and SUBSHR2.COB). Only the subprograms are shareable images.

# Developing HP COBOL Programs

## 1.2 Developing Programs on OpenVMS

### Example 1–2 Main Program and Subprograms

```
* CALLER.COB
IDENTIFICATION DIVISION.
PROGRAM-ID. CALLER.
*****
* This program calls a subprogram installed as a shareable image.*
*****
PROCEDURE DIVISION.
0.
    CALL "SUBSHR1"
        ON EXCEPTION
            DISPLAY "First CALL failed. Program aborted."
    END-CALL.
    STOP RUN.
END PROGRAM CALLER.

* SUBSHR1.COB
IDENTIFICATION DIVISION.
PROGRAM-ID. SUBSHR1.
*****
* This subprogram is linked as a shareable image. When it is called,*
* it calls another subprogram installed as a shareable image.      *
*****
PROCEDURE DIVISION.
0.
    DISPLAY "Call to SUBSHR1 successful. Calling SUBSHR2.".
    CALL "SUBSHR2"
        ON EXCEPTION
            DISPLAY "Second call failed. Control returned to CALLER."
    END-CALL.
END PROGRAM SUBSHR1.

* SUBSHR2.COB
IDENTIFICATION DIVISION.
PROGRAM-ID. SUBSHR2.
*****
* This subprogram is linked as a shareable image and is called by *
* another shareable image.                                         *
*****
PROCEDURE DIVISION.
0.
    DISPLAY "Call to SUBSHR2 successful!".
END PROGRAM SUBSHR2.
```

Example 1–3 shows a command procedure that compiles and links the sample program and subprograms in Example 1–2 on an OpenVMS Alpha system. (Example 1–4 shows an equivalent command procedure for OpenVMS VAX.)

### Example 1–3 Command Procedure to Compile and Link Subprograms as Shareable Images (Alpha, I64)

```
#! Create the main program and subprograms.
#! In this example CALLER.COB is the main program.
#! SUBSHR1.COB and SUBSHR2.COB are the subprograms to be installed
#! as shareable images.
#!
```

(continued on next page)

## Developing HP COBOL Programs 1.2 Developing Programs on OpenVMS

### Example 1–3 (Cont.) Command Procedure to Compile and Link Subprograms as Shareable Images (Alpha, I64)

```
#! Compile the main program and subprograms.
$!
$ COBOL CALLER.COB
$ COBOL SUBSHR1.COB
$ COBOL SUBSHR2.COB
$!
#! Create an options file containing all the universal symbols
#! (entry points and other data symbols) for the subprograms.
$!
$ COPY SYS$INPUT OPTIONS1.OPT
$ DECK
  SYMBOL_VECTOR=(SUBSHR1=PROCEDURE,SUBSHR2=PROCEDURE)
$ EOD
$!
#! Link the subprograms using the /SHARE qualifier to the
#! shareable library and the options file. For more information
#! on options files, refer to the OpenVMS Linker Utility Manual.
$!
$ LINK/SHARE=MYSHRLIB SUBSHR1,SUBSHR2,OPTIONS1/OPT
$!
#! Assign a logical name for the shareable images.
$!
$ ASSIGN DEVICE:[DIRECTORY]MYSHRLIB.EXE MYSHRLIB
$!
#! Create a second options file to map the main program to the
#! shareable image library.
$!
$ COPY SYS$INPUT OPTIONS2.OPT
$ DECK
  MYSHRLIB/SHAREABLE
$ EOD
$!
#! Link the main program with the shareable image subprograms
#! through the options file.
$!
$ LINK CALLER,OPTIONS2/OPT
$!
#! Now you can run the main program.
```

### Using Symbol Vectors with Shareable Images (Alpha, I64)

To make symbols in the shareable image available for other modules to link against, you must declare the symbols as universal. You declare universal symbols by creating a **symbol vector**. You create a symbol vector by specifying the `SYMBOL_VECTOR=option` clause in a linker options file. List all of the symbols you want to be universal in the order in which you want them to appear in the symbol vector.

If you use symbol vectors, you can modify the contents of shareable images and avoid relinking user programs bound to the shareable image when you modify the image. Once you have created the symbol vector, you can install the subprograms using the OpenVMS Install utility (`INSTALL`) and link the main program to the shareable library. Symbol vectors, if used according to the coding conventions, can also provide upward compatibility.

For more information about symbol vectors, refer to the *OpenVMS Linker Utility Manual*. ♦

## Developing HP COBOL Programs

### 1.2 Developing Programs on OpenVMS

#### Linking a Subprogram as a Shareable Image (VAX)

Example 1–4 shows a command procedure that compiles, links, and installs the sample programs in Example 1–2 on OpenVMS VAX systems.

#### Example 1–4 Command Procedure to Compile, Link, and Install Subprograms as Shareable Images (VAX)

```
#!/ Create the main program and subprograms to be installed as shareable
#!/ images. In this example CALLER.COB is the main program. SUBSHR1.COB
#!/ and SUBSHR2.COB are the subprograms to be installed as
#!/ shareable images.
#!/
#!/ Compile the main program and subprograms.
#!/
$ COBOL CALLER.COB
$ COBOL SUBSHR1.COB
$ COBOL SUBSHR2.COB
#!/
#!/ Create an options file to map the entry points of the subprograms.
#!/
$ COPY SYS$INPUT OPTIONS1.OPT
$ DECK
  UNIVERSAL=SUBSHR1,SUBSHR2
$ EOD
#!/
#!/ Link the subprograms using the /SHARE qualifier to the shareable library
#!/ and the options file. For more information on options files, refer to
#!/ the documentation on the OpenVMS Linker.
#!/
$ LINK/SHARE=MYSHRLIB SUBSHR1,SUBSHR2,OPTIONS1/OPT
#!/
#!/ Copy the shareable images to SYS$LIBRARY. To perform this
#!/ you must have [SYSLIB] access privileges. Alternatively,
#!/ you can perform the same function by doing a local assignment.
#!/
#!/ COPY MYSHRLIB.EXE SYS$LIBRARY:*
#!/ or
$ ASSIGN DEVICE:[DIRECTORY]MYSHRLIB.EXE MYSHRLIB
#!/
#!/ Install the shareable images in a shareable library.
#!/ This will allow multiple users to use a single copy of the
#!/ shareable image.
#!/
#!/ If you do not install the shareable library,
#!/ multiple users will each link to their own run-time copy of
#!/ the image.
#!/
#!/ Note that to install an image in a shareable library, you must have
#!/ PRMGBL, SYSGBL, or CMKRNL privileges.
#!/
#!/ Prior to installing the shareable image, check to see if there is
#!/ enough global symbol space.
#!/ MCR INSTALL
#!/ /GLOBAL
#!/ ^Z
#!/
```

(continued on next page)

## Developing HP COBOL Programs 1.2 Developing Programs on OpenVMS

### Example 1–4 (Cont.) Command Procedure to Compile, Link, and Install Subprograms as Shareable Images (VAX)

```
#! Also check to see if there are available global sectors and pages.
#! MCR SYSGEN
#! /GBLSE
#! /GBLPA
#! ^Z
#!
#! The /WRITE qualifier is required if you want to install writable PSECTS.
$ MCR INSTALL
  device:[directory]MYSHRLIB/SHARE/WRITE
#!
#! Create a second options file to map the main program to the shareable
#! image library.
$ COPY SYS$INPUT OPTIONS2.OPT
$ DECK
  MYSHRLIB/SHAREABLE
$ EOD
#!
#! Link the main program with the shareable image subprograms through the
#! options file.
$ LINK CALLER,OPTIONS2/OPT
#!
#! Now you can run the main program.
```

### Using Transfer Vectors (VAX)

Using transfer vectors can be helpful when creating shareable images for the following reasons:

- They make it easy for you to modify the contents of shareable images.
- They allow you to avoid relinking user programs bound to the shareable image if you modify the image.

The command procedure in Example 1–5 shows how to create a transfer vector table and how to link the main program and subprograms (shown in Example 1–2) with the transfer vector table.

### Example 1–5 Transfer Vectors (VAX)

```
#!
#! Create a transfer vector table (TRAVEC.MAR).
$ MACRO /OBJ=TRAVEC SYS$INPUT
  .PSECT TRANSFER_VECTOR
;
;
; The transfer vector table is used to map entry points at
; run time to a shareable library. If you make changes to the
; shareable library, you only have to relink the library.
; You do not have to relink all the programs linked to the
; library.
```

(continued on next page)

## Developing HP COBOL Programs

### 1.2 Developing Programs on OpenVMS

#### Example 1–5 (Cont.) Transfer Vectors (VAX)

```
;
; This example transfer vector table maps the entry points
; of the shareable subprograms: SUBSHR1, SUBSHR2.
;
  .TRANSFER  SUBSHR1
  .MASK      SUBSHR1
  BRW       SUBSHR1+2
  RET
  .QUAD
  .TRANSFER  SUBSHR2
  .MASK      SUBSHR2
  BRW       SUBSHR2+2
  RET
  .QUAD
;
; Note that there must be an entry point for each shareable image.
; Any future additions should be made at the end of the vector.
; The order of the entries must remain intact once established.
; Do not delete any entries (even if the shareable image is deleted).
$
$ LINK/SHARE=MYSHRLIB SUBSHR1,SUBSHR2,TRAVEC
```

Once you have created the transfer vector table, you can install the subprograms and link the main program to the shareable library as shown in Example 1–4.

For more information on transfer vectors, refer to the documentation on the OpenVMS Linker. ♦

#### 1.2.3.6 Interpreting Messages from the Linker

If the linker detects any errors while linking object modules, it displays system messages indicating their cause and severity. If any error or fatal error conditions occur, the linker does not produce an image file. Refer to the *OpenVMS Linker Utility Manual* for complete information about the format of linker options.

Linker messages are self-explanatory; you do not usually need additional information to determine the specific error.

#### Common Linking Errors to Avoid

The following are some common errors to avoid when linking COBOL programs:

- Trying to link a module that produced warning or error messages during compilation. Although you can usually link compiled modules for which the compiler generated system messages, you should verify that the modules actually produce the expected output during program execution.
- Forgetting to specify a file type for an input file that has a file type other than the default on the command line. The linker searches for a file that has a file type `.OBJ` by default. When the linker cannot locate an object file and you have not identified your input file with the appropriate file type, the linker signals an error message and does not produce an image file.
- Trying to link a nonexistent module. The linker signals an error message if you misspell a module name on the command line or if the compilation contains fatal messages.
- Omitting required module or library names from the command line. The linker cannot locate the definition for a specified global symbol reference.



## Developing HP COBOL Programs

### 1.2 Developing Programs on OpenVMS

Consider, for example, the following LINK command for a main program module, OCEAN.OBJ, that calls the subprograms REEF, SHELLS, and SEAWEED:

```
$ LINK OCEAN,REEF,SHELLS
```

If the routine SEAWEED.OBJ does not exist in the directory from which the command is issued, an error occurs and the linker issues the following diagnostic messages:

```
%LINK-W-NUDFSYMS, 1 undefined symbol
%LINK-I-UDFSYMS,          SEAWEED
%LINK-W-USEUNDEF, undefined symbol SEAWEED referenced
      in psect $CODE offset %X0000000C
      in module OCEAN file DEVICE$:[COBOL.EXAMPLES]PROG.OBJ;1
%LINK-W-USEUNDEF, undefined symbol SEAWEED referenced
      in psect $CODE offset %X00000021
      in module OCEAN file DEVICE$:[COBOL.EXAMPLES]PROG.OBJ;1
```

If an error occurs when you link modules, you can often correct it by reentering the command string and specifying the correct modules or libraries. For a complete list of linker options, refer to the *OpenVMS Linker Utility Manual*. For further information on a particular linker message, refer to the online OpenVMS Help Message utility.

#### 1.2.4 Running an HP COBOL Program

After you compile and link your program, use the RUN command to execute it. In its simplest form the RUN command has the following format:

```
$ RUN myprog
```

In the preceding example MYPROG.EXE is the file specification of the image you want to run. If you omit the file type from the file specification, the system automatically provides a default value. The default file type is .EXE. If you omit a path specification, the system will expect MYPROG.EXE to be in the current directory.

When you run your application it makes calls to the HP COBOL Run-Time Library (RTL) installed on your system. If your application is run on a system other than the one where the application was compiled, there are two requirements that must be met:

- The HP COBOL Run-Time Library must be installed.
- The RTL version must match (or be higher than) the version of the RTL on the system where the application was compiled. Otherwise, the system displays a diagnostic message each time you run the application.

##### 1.2.4.1 Accessing Command-Line Arguments at Run Time (Alpha, I64)

Your HP COBOL programs can read command-line arguments and access (read and write) system logicals. Command-line arguments enable you to provide information to a program at run time. Your program provides the logic to parse the command line, identify command-line options, and act upon them. For example, you might develop a program named MYPROG that will extract a given amount of data from a specified file, where both the number of records to read and the file name are highly dynamic, changing for each activation of your program. In this case your program would contain code that reads a command-line argument for the number of records to read and a second argument for the file specification.

## Developing HP COBOL Programs

### 1.2 Developing Programs on OpenVMS

To run the program with command-line arguments, you must define it as a foreign command, as follows:

```
$ MYPROG ::= "$device:[dir]MYPROG.EXE"
```

When you use this command, you will replace *device* and *dir* with the valid device:[dir] names where MYPROG.EXE is located. Your program execution command could then look like the following:

```
$ MYPROG 1028 POWERS.DAT
```

In this hypothetical case, the program MYPROG would read 1,028 records from the file POWERS.DAT.

Multiple command-line arguments are delimited by spaces, as shown in the preceding example. If an argument itself contains spaces, enclose that argument in quotation marks (" ") as follows:

```
$ myprog2 "all of this is argument 1" argument2
```

In this example the returned value of argument1 will be the entire string "all of this is argument1", and argument2 will be simply "argument2".

You provide definitions for the command-line arguments with the SPECIAL-NAMES paragraph in your program's Environment Division, and include ACCEPT and DISPLAY statements in the Procedure Division to parse the command line and access the arguments. Detailed information about command-line argument capability is in the ACCEPT and DISPLAY sections in the *HP COBOL Reference Manual*.

#### 1.2.4.2 Accessing System Logicals at Run Time (Alpha, I64)

You can read and write system logicals at run time through your HP COBOL program.

Example 1–6 allows the user to specify a file specification by putting the directory in the value of the logical COBOLPATH and the file name in a command-line argument.

#### Example 1–6 Accessing Logicals and Command-Line Arguments (Alpha, I64)

```
IDENTIFICATION DIVISION.  
PROGRAM-ID. EXAMPLE.  
ENVIRONMENT DIVISION.  
CONFIGURATION SECTION.  
SPECIAL-NAMES.  
    SYSERR          IS STANDARD-ERROR  
    ENVIRONMENT-NAME IS NAME-OF-LOGICAL  
    ENVIRONMENT-VALUE IS LOGICAL-VALUE  
    ARGUMENT-NUMBER IS POS-OF-COMMAND-LINE-ARGUMENT  
    ARGUMENT-VALUE  IS COMMAND-LINE-ARGUMENT.  
DATA DIVISION.  
WORKING-STORAGE SECTION.  
01 howmany-records PIC 9(5).  
01 env-dir PIC x(50).  
01 file-name PIC x(50).  
01 file-spec PIC x(100).
```

(continued on next page)

**Example 1–6 (Cont.) Accessing Logicals and Command-Line Arguments**  
**(Alpha, I64)**

```
PROCEDURE DIVISION.  
BEGIN.  
    ACCEPT howmany-records FROM COMMAND-LINE-ARGUMENT  
    ON EXCEPTION  
        DISPLAY "No arguments specified"  
        UPON STANDARD-ERROR  
    STOP RUN  
END-ACCEPT.  
  
DISPLAY "COBOLPATH" UPON NAME-OF-LOGICAL.  
ACCEPT env-dir FROM LOGICAL-VALUE  
ON EXCEPTION  
    DISPLAY "Logical COBOLPATH is not set"  
    UPON STANDARD-ERROR  
END-DISPLAY  
    NOT ON EXCEPTION  
ACCEPT file-name FROM COMMAND-LINE-ARGUMENT  
ON EXCEPTION  
    DISPLAY  
    "Attempt to read beyond end of command line"  
    UPON STANDARD-ERROR  
END-DISPLAY  
NOT ON EXCEPTION  
    STRING env-dir file-name delimited by " " into file-spec  
    DISPLAY "Would have read " howmany-records " records from " file-spec  
END-ACCEPT  
END-ACCEPT.
```

Example 1–6 assumes that the logical COBOLPATH is set as follows:

```
$ define COBOLPATH MYDEV:[MYDIR]
```

When you execute the following command line:

```
$ MYPROG 1028 powers.dat
```

The following will result:

- howmany-records will contain 1028.
- file-path will contain MYDEV:[MYDIR]
- file-name will contain powers.dat
- file-spec will contain MYDEF:[MYDIR]powers.dat

For additional information, refer to the ACCEPT and DISPLAY statements in the *HP COBOL Reference Manual*. ♦

#### **1.2.4.3 Accessing Input and Output Devices at Run Time**

ACCEPT and DISPLAY statements may interact with the input and output devices by referring to them through the environment variables COBOL\_INPUT and COBOL\_OUTPUT, respectively. See Chapter 11 for more information.

## Developing HP COBOL Programs

### 1.2 Developing Programs on OpenVMS

#### 1.2.4.4 Debugging Environment

Perhaps the most common qualifier added to the RUN command line is DEBUG. The form of the RUN command with DEBUG is as follows:

```
RUN [/[NO]DEBUG] file-spec
```

In the preceding syntax format, *file-spec* is the name of the executable image to be run. A typical example would be:

```
$ RUN /DEBUG MYPROG
```

In this example, MYPROG is the name of the executable image to be run. You would specify the /DEBUG qualifier to invoke the OpenVMS Debugger if the image was not linked with it. You cannot use /DEBUG on images linked with the /NOTRACEBACK qualifier. If the image (in this case, MYPROG) was linked with the /DEBUG qualifier and you do not want the debugger to prompt you, use the /NODEBUG qualifier. The default action depends on whether or not the file was linked with the /DEBUG qualifier.

---

#### Note

---

Using the /DEBUG qualifier with the RUN command does not produce symbol table information if you did not specify the /DEBUG qualifier when you compiled and linked your program.

---

The following example executes the image MYPROG.EXE without invoking the debugger:

```
$ RUN MYPROG/NODEBUG
```

See Appendix C for more information about debugging programs.

#### 1.2.4.5 Interpreting Run-Time Messages

During execution, an image can generate a fatal error called an **exception condition**. When an exception condition occurs, the system displays a message. Run-time messages can also be issued by the OpenVMS system or by other utilities such as SORT. Other kinds of errors that can occur at run time include program run errors and run-time input/output errors.

Run-time messages have the following format:

```
%COB-s-ident, message-text
```

##### **%COB**

The program name of the HP COBOL Run-Time Library. This prefix indicates a run-time message.

##### **s**

The severity of the error. As with messages from the compiler and the linker, the severity indicator can be F (Fatal), E (Error), W (Warning), or I (Informational).

##### **ident**

The message identification. This is a descriptive abbreviation of the message text.

##### **message-text**

The run-time message. This portion may contain more than one line of output. A message generally provides you with enough information to determine the cause of the error so that you can correct it.

## Developing HP COBOL Programs

### 1.2 Developing Programs on OpenVMS

The following example shows a run-time message issued for an illegal divide:

```
%COB-E-DIVBY-ZER, divide by zero; execution continues
```

Both the compiler and the OpenVMS Run-Time Library include facilities for detecting and reporting errors. You can use the OpenVMS Debugger and the traceback facility to help you locate errors that occur during program execution. For a description of HP COBOL run-time messages, use the HELP COBOL Run-Time Messages command.

#### Run-Time Messages

Faulty program logic can cause abnormal termination. If errors occur at run time, the Run-Time Library (RTL) displays a message with the same general format as system error messages. In addition, the system traceback facility displays a list of the routines that were active when the error occurred.

When an error occurs, TRACEBACK produces a symbolic dump of the active call frames. A **call frame** represents one execution of a routine. For each call frame, TRACEBACK displays the following information:

1. The module name (program-id)
2. The routine name (program-id)
3. The source listing line number where the error or CALL occurred
4. Program-counter (PC) information

You can also use the OpenVMS Debugger to examine the machine code instruction. To do this, compile and link the program using the /DEBUG qualifier. When you run the program, you automatically enter the debugger. Once in the debugger, you could use the EXAMINE/INSTRUCTION command to examine the contents of the failed instruction. You could also use the debugger in screen mode, which would indicate where the error occurred.

For more information about the OpenVMS Debugger, refer to Appendix C and the *OpenVMS Debugger Manual*.

## 1.3 HP COBOL and Alpha and I64 Architecture System Resources

For many user applications, the HP COBOL compiler requires significantly more system resources than HP COBOL for OpenVMS VAX. In fact, unless you have adjusted your system resource parameters accordingly, the attempt to compile may fail because of insufficient virtual memory. Also, for very large programs (greater than 10,000 lines), you might experience extremely long compile times. Knowing why HP COBOL requires more memory can help you take actions to avoid resource problems.

### 1.3.1 Compilation Performance

The Alpha and I64 architectures are RISC (reduced instruction set computer) architectures. Many other processor architectures, including the VAX, are CISC (complex instruction set computer) architectures. The main distinguishing characteristic of a RISC machine is that it has few instructions and each instruction does a small amount of work. A CISC machine generally has many instructions, most of which perform many complicated operations in one step.

## Developing HP COBOL Programs

### 1.3 HP COBOL and Alpha and I64 Architecture System Resources

By reducing the amount of work that is done in each instruction (and by reducing the *number* of instructions), the complexity of the hardware is reduced. These hardware changes, plus others, result in an increase in the number of instructions per second that can be completed. The result is much faster overall system performance.

A tradeoff of RISC systems is that compilers for these architectures generally must do a great deal more work than a corresponding compiler for a CISC architecture. For example, the compiler must compute the best way to use all of the functional units of the processor, and it must determine how to make the best use of registers and on-chip data cache because reads and writes to main memory are generally slow compared to the speed of the processor.

The code generation portion of the HP COBOL for OpenVMS VAX compiler was developed for the CISC architecture of the VAX. The compiler examines one COBOL statement at a time, determines the VAX instructions to be constructed to execute that statement, and then moves on to the next one. Subsequently it uses "Peephole" optimization to enhance the performance of the generated machine code.

On the other hand, the HP COBOL compiler was developed for the Alpha and I64 architectures. It is a globally optimizing compiler based on the most recent compiler technology. It does many optimizations including Peephole, loop unrolling, and instruction pipelining. Also, the compiler uses mathematical graph theory to construct an internal representation of the entire COBOL program, and it repeatedly traverses this structure at compile time, to produce the most efficient machine code for the program. This results in very high performance code, to the benefit of your users at run time. Although the HP COBOL compiler on OpenVMS Alpha and I64 requires more resources than some other compilers to do this additional work at compile time, this cost is offset by better performance during the many run times that follow.

To reduce the impact on system resources at compile time, do the following:

- Use `/NOOPTIMIZE` or `-00` on the compile command line when initially developing and testing programs. The optimizer is one of the heaviest users of system resources in the COBOL compiler and is turned on by default. Also, the higher the optimization level, the more memory required by the compiler.
- Check system tuning. Because the HP COBOL compiler often needs a great deal of virtual memory, you may need to increase virtual memory for developers who use the compiler. This results in decreased paging and improvements in compile time.
- Check program sizes. Larger amounts of system resources are used during compilation for large monolithic source files. It is possible that your application is already composed of several separately compiled program units (different PROGRAM IDs not nested), but all in the same `.COB`. On Alpha and I64 systems with HP COBOL, compilation performance improves if you split the program units into separate (smaller) `.COB` files (possibly one for each separately compiled program unit).

---

#### Note

---

Large arrays (tables) can have a significant impact on compile time and resource requirements. In addition to the size of the program source, you should also examine the amount of space allocated in your Data Division, particularly for arrays. The number of array elements as well as the

## 1.3 HP COBOL and Alpha and I64 Architecture System Resources

size of the array elements is significant. This impact can be minimized in two ways: by system tuning (as suggested in this section), which will optimize system resources for the compile, and by using INITIALIZE instead of VALUE in your data definitions, which will improve compilation performance.

---

### 1.3.2 Tuning OpenVMS Alpha and OpenVMS I64 for Large HP COBOL Compiles

The recommendations that follow were determined by compiling one set of very large HP COBOL modules on OpenVMS Alpha and I64. While your results may vary, the principles are generally applicable. For more detailed information on OpenVMS Alpha tuning, refer to the *OpenVMS System Manager's Manual*, particularly the sections on *Managing System Parameters* and *Managing System Page, Swap, and Dump Files*.

Note that many tuning exercises are more beneficial if you work with a relatively quiet system, submit batch jobs, and retain the log files for later analysis.

#### 1.3.2.1 Optimizing Virtual Memory Usage

If your system does not have enough virtual memory allocated, the compile may fail, with the “%LIB-E-INSVIRMEM, insufficient virtual memory” error reported.

OpenVMS has two parameters that control the amount of virtual memory available to a process. One is the system generation parameter VIRTUALPAGECNT, which sets an upper bound on the number of pagelets of virtual memory for any process in the system. The other control is the AUTHORIZE parameter PGFLQUOTA, which determines the number of pagelets a process can reserve in the system's page file(s).

After an “insufficient virtual memory” error, you can issue the DCL command \$SHOW PROCESS/ACCOUNTING to see the “Peak virtual size” used by the process (or look at the “Peak page file size” at the end of a batch job log file). If the peak size is at the system generation parameter VIRTUALPAGECNT, you will need to raise this value. If the peak size is below VIRTUALPAGECNT, and at or above PGFLQUOTA, run AUTHORIZE to increase PGFLQUOTA for the COBOL users. (Peak size can exceed PGFLQUOTA because some virtual memory, such as read-only image code, is not allocated page file space.)

It is difficult to predict precisely how much virtual memory will be required for a compilation, but a starting point for system tuning may be computed by multiplying 250 times the size of the largest program in disk blocks (including all COPY files referenced). Alternatively, multiply 25 times the number of lines in the program (including all COPY files).

The resulting figure can then be used as a starting point for the system generation parameter VIRTUALPAGECNT. Put that figure in the parameter file SYS\$SYSTEM:MODPARAMS.DAT. For example, if you estimate 370,000 pages, add the following line in MODPARAMS, run AUTOGEN and reboot:

```
MIN_VIRTUALPAGECNT = 400000
```

If the compilation now completes successfully, use the command \$SHOW PROCESS/ACCOUNTING to determine the Peak Virtual Size; if the actual peak is significantly less than the value computed above, you can reduce VIRTUALPAGECNT.

## Developing HP COBOL Programs

### 1.3 HP COBOL and Alpha and I64 Architecture System Resources

When modifying VIRTUALPAGECNT and PGFLQUOTA, you may also need to increase the size of the page file.

#### 1.3.2.2 Optimizing Physical Memory Usage

In any evaluation of your system's physical memory, two of the questions to consider are:

Is there enough memory on the system?

Is enough available to the process running the compilation?

More specifically:

- If the physical memory on the system is too small, the command \$LOGOUT/FULL (which is automatically issued at the end of a batch job) will show a high number of faults (>100,000 for a single compilation) and an elapsed time value that greatly exceeds the Charged CPU time value, as the system waits for disk I/Os to resolve page faults. In this situation, tuning attempts may be of limited benefit.
- If the physical memory on the system is adequate, but the physical memory allotted to the process running the compilation is too small, you may still observe a large number of faults, but elapsed time may remain closer to CPU time. This is because OpenVMS Alpha and OpenVMS I64 resolve page faults from the page caches (free list, modified list) whenever possible, avoiding the relatively slow disk I/Os. In this situation, basic tuning may also be beneficial.

The amount of physical memory required will vary, but it should be a large percentage of the process peak virtual size—as close to 100% as practical. The reason is that the compiler makes multiple passes over the internal representation of the program. A page that falls out of the working set in one pass is probably going to be needed again on the very next pass.

The physical memory present on the system can be determined by the DCL command \$SHOW MEMORY/PHYSICAL. The physical memory used by the compilation is reported as “Peak working set size” by the command SHOW PROCESS/ACCOUNTING or at the end of a batch log file.

More physical memory can be made available to a process by minimizing the number of competing processes on the system (for example, by compiling one module at a time or by scheduling large compiles for off-peak time periods; late at night is a good time in some situations).

More physical memory can also be made available to a process (if it is present on the machine) by adjusting the system generation parameter WSMAX and the corresponding WSEXTENT (in AUTHORIZE). Approach such adjustments with great caution, as the system may hang if memory is oversubscribed and you create a situation where OpenVMS Alpha and OpenVMS I64 effectively have no options to reclaim memory. The following guidelines can help:

- Set the COBOL user WSEXTENT (in AUTHORIZE or INITIALIZE/QUEUE) to match WSMAX.
- Keep WSQUOTA (in AUTHORIZE or INITIALIZE/QUEUE) low. Make sure that no process or batch queue has a WSQUOTA of more than approximately 20% of physical memory. The difference between WSEXTENT and WSQUOTA allows the operating system to manage memory to meet varying demands.
- Use AUTOGEN. AUTOGEN will attempt to make a consistent set of changes that do not interfere with each other.



### 1.3 HP COBOL and Alpha and I64 Architecture System Resources

By default, AUTOGEN will set the maximum working set (system generation parameter WSMAX) to 25% of physical memory. This value is reasonable for a workstation or multi-user system with many active processes.

WSMAX can be increased to a somewhat larger value by editing MODPARAMS.DAT. For a system with 64 MB<sup>1</sup> of physical memory, set WSMAX to no more than approximately 40% of physical memory, or 52000 pagelets (1 MB = 2048 pagelets). With 128 MB or more of physical memory, a setting of 50% of physical memory can be attempted.

The effects of physical memory on compilation time were studied for a set of seven large modules. These modules ranged in size from approximately 1600 to 3300 disk blocks. Your results may differ, but to give a rough appreciation for the effect of physical memory on compilation time, note that:

- When the amount of physical memory available to the processes matched the amount of virtual memory, the elapsed times were close to the CPU times.
- As the physical memory was reduced, CPU times rose only slightly—approximately 10%.
- As the physical memory was reduced, elapsed times were elongated, at the rate of approximately 1 hour for each 100 MB of difference between Peak Virtual Size and the actual memory available. For example, when compiling a program that used a Peak Virtual Size of 947760 pagelets, or 463 MB, on a system where approximately 180 MB of physical memory was available to user processes, the compile required approximately 3 hours more than on a 512 MB system.

Your results may differ from those shown in this section and will be strongly affected by the speed of the devices that are used for paging.

Note that the requirements for virtual memory and physical memory can also be reduced by breaking large modules into smaller modules.

#### 1.3.2.3 Improving Compile Performance with Separate Compilation (Alpha, I64)

The /SEPARATE\_COMPILATION qualifier can improve compile-time performance for large source files that are made up of multiple separately compiled programs (SCPs). For programs compiled without this qualifier, the compiler engine parses the entire compilation unit and uses system resources (sized for the total job) for the duration of this compilation. When you use the /SEPARATE\_COMPILATION qualifier, the compilation is replaced by a smaller series of operations, and memory structures that are needed for individual procedures are reclaimed and recycled. See Section 1.2.2.4 for additional information. ♦

#### 1.3.3 Choosing a Reference Format

You need to choose a reference format before you set out to write an HP COBOL program, and you must be aware of the format at compile time. The HP COBOL compiler accepts source code written in either terminal or ANSI reference format. You cannot mix reference formats in the same source file.

On OpenVMS, when copying text from Oracle CDD/Repository, the HP COBOL compiler translates the record descriptions into the reference format of the source program. ♦

---

<sup>1</sup> MB= megabytes

## Developing HP COBOL Programs

### 1.3 HP COBOL and Alpha and I64 Architecture System Resources

#### 1.3.3.1 Terminal Reference Format

Hewlett-Packard recommends using terminal format, an HP optional format, when you create source files from interactive terminals. The compiler accepts terminal format as the default reference format.

**Terminal format** eliminates the line number and identification fields of ANSI format and allows horizontal tab characters and short lines. Terminal format saves disk space and decreases compile time. It is easier to edit source code written in terminal format.

The following table shows the structure and content of a terminal reference source line: To select ANSI format, specify the `-ansi` flag (on Tru64 UNIX systems) or the `/ANSI_FORMAT` qualifier (on OpenVMS systems) at compile time. You can choose this format if your COBOL program is written for a compiler that uses ANSI format.

For ANSI format, the compiler expects 80-character program lines. The following table shows the structure and content of an ANSI reference source line:

Character Positions	Contents
1 to 6	Optional sequence numbers
7	Indicators
8 to 11	Area A
12 to 72	Area B
73 to 80	Optional Area

For more information about the two reference formats, refer to the *HP COBOL Reference Manual*.

#### 1.3.3.2 Converting Between Reference Formats

The REFORMAT utility allows you to convert a terminal format program to ANSI format and vice versa. You can also use REFORMAT to match the formats of HP COBOL source files and library files when their formats are not the same. See Chapter 14 for a description of the REFORMAT utility.

## 1.4 Program Run Messages

Incorrect or undesirable program results are usually caused by data errors or program logic errors. You can resolve most of these errors by desk-checking your program and by using a debugger.

### 1.4.1 Data Errors

Faulty or incorrectly defined data often produce incorrect results. Data errors can sometimes be attributed to one or more of the following actions:

- **Incorrect picture size.** As shown in the following sample of a partial program, if the picture size of a receiving data item is too small, your data may be truncated:

## Developing HP COBOL Programs 1.4 Program Run Messages

```
77  COUNTER  PIC S9.  
    .  
    .  
PROCEDURE DIVISION.  
    .  
    .  
    LOOP.  
        ADD 1 TO COUNTER  
        IF COUNTER < 10 GO TO LOOP.
```

The IF clause will produce an infinite loop because of the one-digit size limit of COUNTER, which is PIC S9. If COUNTER were PIC S99, or if the clause used 9 instead of 10, the condition could be false, causing a proper exit from the loop.

- Incorrect record field position. The record field positions that you specify in your program may not agree with a file's record field positions. For example, a file could have this record description:

```
01  PAY-RECORD.  
    03  P-NUMBER          PIC X(5).  
    03  P-WEEKLY-AMT     PIC S9(5)V99  COMP-3.  
    03  P-MONTHLY-AMT    PIC S9(5)V99  COMP-3.  
    03  P-YEARLY-AMT     PIC S9(5)V99  COMP-3.  
    .  
    .
```

Incorrectly positioning these fields can produce faulty data.

In the following example, a program references the file incorrectly. The field described as P-YEARLY-AMT actually contains P-MONTHLY-AMT data, and vice versa.

```
01  PAY-RECORD.  
    03  P-NUMBER          PIC X(5).  
    03  P-WEEKLY-AMT     PIC S9(5)V99  COMP-3.  
    03  P-YEARLY-AMT     PIC S9(5)V99  COMP-3.  
    03  P-MONTHLY-AMT    PIC S9(5)V99  COMP-3.  
    .  
    .  
PROCEDURE DIVISION.  
ADD-TOTALS.  
    ADD P-MONTHLY-AMT TO TOTAL-MONTHLY-AMT.  
    .  
    .
```

You can minimize record field position errors by writing your file and record descriptions in a library file and then using the COPY statement in your programs. On OpenVMS systems, you can also use the COPY FROM DICTIONARY statement.

Choosing your test data carefully can minimize faulty data problems. For instance, rather than using actual or ideal data, use test files that include data extremes.

Determining when a program produces incorrect results can often help your debugging effort. You can do this by maintaining audit counts (such as total master in = nnn, total transactions in = nnn, total deletions = nnn, total master out = nnn) and displaying the audit counts when the program ends. Using

## Developing HP COBOL Programs

### 1.4 Program Run Messages

conditional compilation lines (see Section 1.2.2.7) in your program can also help you to debug it.

#### 1.4.2 Program Logic Errors

When checking your program for logic errors, first examine your program for some of the more obvious bugs, such as the following:

- Hidden periods. Periods inadvertently placed in a statement usually produce unexpected results. For example:

```
050-DO-WEEKLY-TOTALS.  
  IF W-CODE = "W"  
    PERFORM 100-WEEKLY-SUMMARY  
    ADD WEEKLY-AMT TO WEEKLY-TOTALS.  
    GO TO 000-READ-A-MASTER.  
  WRITE NEW-MASTER-REC.
```

The period at the end of `ADD WEEKLY-AMT TO WEEKLY-TOTALS` terminates the scope of the `IF` statement and changes the logic of the program. Including the extra period before the `GO TO` statement transforms `GO TO 000-READ-A-MASTER` from a conditional statement to an unconditional statement. Because the `GO TO` statement is not within the scope of the `IF` statement, it will always be executed. In addition, the `WRITE` statement following the `GO TO` will never be executed.

- Tests for equality, which can cause an infinite loop if the procedure is to be executed until the test condition is met, for example:

```
* This is a test for equality  
PERFORM ABC-ROUTINE UNTIL A-COUNTER = 10.
```

If, during execution, the program increments `A-COUNTER` by a value other than 1 (2 or 1.5, for example), `A-COUNTER` may never equal 10, causing a loop in `ABC-ROUTINE`. You can prevent this type of error by changing the statement to something like this:

```
* This is a test for inequality  
PERFORM ABC-ROUTINE UNTIL A-COUNTER > 9
```

- Testing two floating point numbers (for example, `COMP-1` and `COMP-2` fields) for equality. The calculations of your program might never produce *exact* numerical equality between two floating point values.
- Two negative test conditions combined with an `OR`. The object of the following statement is to execute `GO TO 200-PRINT-REPORT` when `TEST-FIELD` contains other than an `A` or `B`. However, the `GO TO` always executes because no matter what `TEST-FIELD` contains, one of the conditions is always true.

```
IF TEST-FIELD NOT = "A" OR NOT = "B"  
  GO TO 200-PRINT-REPORT.
```

```
.  
. .  
.
```

The following statement does not contain the logic error:

```
IF TEST-FIELD NOT = "A" AND NOT = "B"  
  GO TO 200-PRINT-REPORT.
```

```
.  
. .  
.
```

### 1.4.3 Run-Time Input/Output Errors

An **input/output error** is a condition that causes an I/O statement to fail. These I/O errors are detected at run time by the I/O system. Each time an I/O operation occurs, the I/O system generates a two-character file status value. One way to determine the nature of an I/O error is to check a file's I/O status by using file status data items. (Refer to the *HP COBOL Reference Manual* for a list of file status values.) See Chapter 7, Handling Input/Output Exception Conditions for additional information about I/O exception condition handling.

Checking a file's I/O status within a Declarative USE procedure or in an INVALID KEY imperative condition can help you determine the nature of an I/O error. For example:

```
FD INDEXED-MASTER
   ACCESS MODE IS DYNAMIC
   FILE STATUS IS MASTER-STATUS
   RECORD KEY IN IND-KEY.
.
.
.
WORKING-STORAGE SECTION.
01 MASTER-STATUS      PIC XX  VALUE SPACES.
.
.
.
PROCEDURE DIVISION.
.
.
.
050-READ-MASTER.
   READ INDEXED-MASTER
   INVALID KEY PERFORM 100-CHECK-STATUS
   GO TO 200-INVALID-READ.
.
.
.
100-CHECK-STATUS.
   IF MASTER-STATUS = "23"
     DISPLAY "RECORD NOT IN FILE".
   IF MASTER-STATUS = "24"
     DISPLAY "BOUNDARY VIOLATION OR RELATIVE RECORD
     NUMBER TOO LARGE".
.
.
.
```

If your program contains a Declarative USE procedure for a file and an I/O operation for that file fails, the I/O system performs the USE procedure, but does not display an error message.

A Declarative USE procedure can sometimes avoid program termination. For example, File Status 91 indicates that the file is locked by another program; rather than terminate your program, you can perform other procedures and then try reopening the file. If program continuation is not desirable, the Declarative USE procedure can perform housekeeping functions, such as saving data or displaying program-generated diagnostic messages.

If you specify an INVALID KEY phrase for a file and the I/O operation causes an INVALID KEY condition, the I/O system performs the associated imperative statement and no other file processing for the current statement. The Declarative USE procedure (if any) is not performed. The INVALID KEY phrase processes I/O errors due to invalid key conditions only.

## Developing HP COBOL Programs

### 1.4 Program Run Messages

If you do not specify an INVALID KEY phrase but declare a Declarative USE procedure for the file, the I/O system performs the Declarative USE procedure and returns control to the program.

If a severe error occurs and you do not have a Declarative Use procedure, your program will terminate abruptly with a run-time diagnostic. For example, given a program that looks for AFILE.DAT and that file is missing:

```
cobrtl: severe: file AFILE.DAT not found
```

In this case, program run ends because you have not handled the error with a Declarative Use procedure.

#### 1.4.4 I/O Errors and RMS (OpenVMS)

I/O errors are detected by the I/O system, which (for OpenVMS systems) consists of Record Management Services (RMS) and the Run-Time Library (RTL). You can use the RMS special registers, which contain the primary and secondary RMS completion codes of an I/O operation, to detect errors. The RMS special registers are as follows:

```
RMS-STS  
RMS-STV  
RMS-FILENAME  
RMS-CURRENT-STS  
RMS-CURRENT-STV  
RMS-CURRENT-FILENAME
```

Refer to the *HP COBOL Reference Manual* and the *OpenVMS Record Management Services Reference Manual* for more information about RMS special registers.

Examples 1–7 and 1–8 show how to use RMS special registers to detect errors.

#### Example 1–7 Using RMS Special Registers to Detect Errors (OpenVMS)

```
IDENTIFICATION DIVISION.  
PROGRAM-ID. RMSSPECREGS.  
*  
* This program demonstrates the use of RMS special registers to  
* implement a different recovery for each of several errors with RMS files.  
*  
ENVIRONMENT DIVISION.  
INPUT-OUTPUT SECTION.  
FILE-CONTROL.  
    SELECT OPTIONAL EMP-FILE ASSIGN "SYS$DISK:ART.DAT".  
    SELECT REPORT-FILE      ASSIGN "SYS$OUTPUT".
```

(continued on next page)

## Developing HP COBOL Programs 1.4 Program Run Messages

### Example 1-7 (Cont.) Using RMS Special Registers to Detect Errors (OpenVMS)

```
DATA DIVISION.
FILE SECTION.
FD EMP-FILE VALUE OF ID IS VAL-OF-ID.
01 EMP-RECORD.
   02 EMP-ID      PIC 9(7).
   02 EMP-NAME    PIC X(15).
   02 EMP-ADDRESS PIC X(30).
FD REPORT-FILE   REPORT IS RPT.
WORKING-STORAGE SECTION.
01 VAL-OF-ID     PIC X(20).
01 RMS$ EOF      PIC S9(9) COMP VALUE EXTERNAL RMS$ EOF.
01 SS$ BADFILENAME PIC S9(9) COMP VALUE EXTERNAL SS$ BADFILENAME.
01 RMS$ FNF      PIC S9(9) COMP VALUE EXTERNAL RMS$ FNF.
01 RMS$ DNF      PIC S9(9) COMP VALUE EXTERNAL RMS$ DNF.
01 RMS$ DEV      PIC S9(9) COMP VALUE EXTERNAL RMS$ DEV.
01 D-DATE        PIC 9(6).
01 EOF-SW        PIC X.
   88 E-O-F VALUE "E".
   88 NOT-E-O-F VALUE "N".
01 VAL-OP-SW     PIC X.
   88 VALID-OP VALUE "V".
   88 OP-FAILED VALUE "F".
01 OP            PIC X.
   88 OP-OPEN  VALUE "O".
   88 OP-CLOSE VALUE "C".
   88 OP-READ  VALUE "R".
REPORT SECTION.
RD RPT PAGE 26 LINES HEADING 1 FIRST DETAIL 5.
01 TYPE IS PAGE HEADING.
   02 LINE IS PLUS 1.
   03 COLUMN 1 PIC X(16) VALUE "Emplyee File on".
   03 COLUMN 18 PIC 99/99/99 SOURCE D-DATE.
   02 LINE IS PLUS 2.
   03 COLUMN 2 PIC X(5) VALUE "Empid".
   03 COLUMN 22 PIC X(4) VALUE "Name".
   03 COLUMN 43 PIC X(7) VALUE "Address".
   03 COLUMN 60 PIC X(4) VALUE "Page".
   03 COLUMN 70 PIC ZZ9 SOURCE PAGE-COUNTER.
01 REPORT-LINE TYPE IS DETAIL.
   02 LINE IS PLUS 1.
   03 COLUMN IS 1 PIC 9(7) SOURCE EMP-ID.
   03 COLUMN IS 20 PIC X(15) SOURCE IS EMP-NAME.
   03 COLUMN IS 42 PIC X(30) SOURCE IS EMP-ADDRESS.
PROCEDURE DIVISION.
DECLARATIVES.
USE-SECT SECTION.
   USE AFTER STANDARD ERROR PROCEDURE ON EMP-FILE.
CHECK-RMS-SPECIAL-REGISTERS.
   SET OP-FAILED TO TRUE.
   EVALUATE RMS-ST$ OF EMP-FILE TRUE
   WHEN (RMS$ EOF) OP-READ
     SET VALID-OP TO TRUE
     SET E-O-F TO TRUE
   WHEN (SS$ BADFILENAME) OP-OPEN
   WHEN (RMS$ FNF) OP-OPEN
   WHEN (RMS$ DNF) OP-OPEN
   WHEN (RMS$ DEV) OP-OPEN
     DISPLAY "File cannot be found or file spec is invalid"
     DISPLAY RMS-FILENAME OF EMP-FILE
     DISPLAY "Enter corrected file (control-Z to STOP RUN): "
     WITH NO ADVANCING
```

(continued on next page)

# Developing HP COBOL Programs

## 1.4 Program Run Messages

### Example 1-7 (Cont.) Using RMS Special Registers to Detect Errors (OpenVMS)

```
ACCEPT VAL-OF-ID
AT END STOP RUN
END-ACCEPT
WHEN ANY OP-CLOSE
CONTINUE
WHEN ANY RMS-STS OF EMP-FILE IS SUCCESS
SET VALID-OP TO TRUE
WHEN OTHER
IF RMS-STV OF EMP-FILE NOT = ZERO
THEN
CALL "LIB$STOP" USING
BY VALUE RMS-STS OF EMP-FILE
END-IF
END-EVALUATE.
END DECLARATIVES.
MAIN-PROG SECTION.
000-DRIVER.
PERFORM 100-INITIALIZE.
PERFORM WITH TEST AFTER UNTIL E-O-F
GENERATE REPORT-LINE
READ EMP-FILE
END-PERFORM.
PERFORM 200-CLEANUP.
STOP RUN.
100-INITIALIZE.
ACCEPT D-DATE FROM DATE.
DISPLAY "Enter file spec of employee file: " WITH NO ADVANCING.
ACCEPT VAL-OF-ID.
PERFORM WITH TEST AFTER UNTIL VALID-OP
SET VALID-OP TO TRUE
SET OP-OPEN TO TRUE
OPEN INPUT EMP-FILE
IF OP-FAILED
THEN
SET OP-CLOSE TO TRUE
CLOSE EMP-FILE
END-IF
END-PERFORM.
OPEN OUTPUT REPORT-FILE.
INITIATE RPT.
SET NOT-E-O-F TO TRUE.
SET OP-READ TO TRUE.
READ EMP-FILE.
200-CLEANUP.
TERMINATE RPT.
SET OP-CLOSE TO TRUE.
CLOSE EMP-FILE REPORT-FILE.
END PROGRAM RMSSPECREGS.
```



## Developing HP COBOL Programs 1.4 Program Run Messages

### Example 1-8 Using RMS-CURRENT Special Registers to Detect Errors (OpenVMS)

```
IDENTIFICATION DIVISION.
PROGRAM ID. RMS-CURRENT-SPEC-REGISTERS.
*
* This program demonstrates the use of RMS-CURRENT special registers
* to implement a single recovery for RMS file errors with multiple files.
*
ENVIRONMENT DIVISION.
INPUT-OUTPUT SECTION.
FILE-CONTROL.
SELECT FILE-1
    ASSIGN TO "SYS$DISK:ART_1.DAT".
SELECT FILE-2
    ASSIGN TO "SYS$DISK:ART_2.DAT".
SELECT FILE-3
    ASSIGN TO "SYS$DISK:ART_3.DAT".
DATA DIVISION.
FILE SECTION.
FD      FILE-1.
01      FILE-1-REC.
         02      F1-REC-FIELD      PIC 9(9).
FD      FILE-2.
01      FILE-2-REC.
         02      F2-REC-FIELD      PIC 9(9).
FD      FILE-3.
01      FILE-3-REC.
         02      F3-REC-FIELD      PIC 9(9).
PROCEDURE DIVISION.
DECLARATIVES.
USE-SECT SECTION.
    USE AFTER STANDARD EXCEPTION PROCEDURE ON INPUT.
CHECK-RMS-CURRENT-REGISTERS.
    DISPLAY "***** ERROR *****".
    DISPLAY "Error on file: " RMS-CURRENT-FILENAME.
    DISPLAY "Status Values:".
    DISPLAY "      RMS-STs = " RMS-CURRENT-STs WITH CONVERSION.
    DISPLAY "      RMS-STV = " RMS-CURRENT-STV WITH CONVERSION.
    DISPLAY "*****".
END DECLARATIVES.
MAIN-PROG SECTION.
MAIN-PARA.
    OPEN INPUT FILE-1.
    OPEN INPUT FILE-2.
    OPEN INPUT FILE-3.
    .
    .
    .
    CLOSE FILE-1.
    CLOSE FILE-2.
    CLOSE FILE-3.
    STOP RUN.
END-PROGRAM RMS-CURRENT-SPEC-REGISTERS.      ◆
```

## Developing HP COBOL Programs

### 1.5 Using Program Switches

## 1.5 Using Program Switches

You can control program execution by defining **switches** in your HP COBOL program and setting them internally (from within the image) or externally (from outside the image). Switches exist as the environment variable COBOL\_SWITCHES (on the Tru64 UNIX operating system) or the logical name COB\$SWITCHES (on the OpenVMS operating system).

On OpenVMS systems, switches can be defined for the image, process, group, or system. ♦

On Tru64 UNIX systems, switches can be defined for the image or process. ♦

### 1.5.1 Setting and Controlling Switches Internally

To set switches from within the image, define them in the SPECIAL-NAMES paragraph of the ENVIRONMENT DIVISION and use the SET statement in the PROCEDURE DIVISION to specify switches ON or OFF, as in the following example:

```
ENVIRONMENT DIVISION.  
CONFIGURATION SECTION.  
SPECIAL-NAMES.  
    SWITCH 10 IS MY-SWITCH  
        ON IS SWITCH-ON  
        OFF IS SWITCH-OFF.  
    .  
    .  
    .  
PROCEDURE DIVISION.  
000-SET-SWITCH.  
    SET MY-SWITCH TO ON.  
    IF SWITCH-ON  
        THEN  
        DISPLAY "Switch 10 is on".  
    .  
    .  
    .
```

On OpenVMS systems, SET in COBOL will attempt to write a user mode logical name (COB\$SWITCHES) to the first entry in the LNM\$FILE\_DEV chain. It will therefore fail if that logical name table denies WRITE access.

To change the status of internal switches during execution, turn them on or off from within your program. However, be aware that this information is not saved between runs of the program.

Refer to the *HP COBOL Reference Manual* for more information about setting internal switches.

### 1.5.2 Setting and Controlling Switches Externally

Switches that are set externally are handled differently on Tru64 UNIX and OpenVMS, as described in this section.

#### Switches on Tru64 UNIX

On Tru64 UNIX systems, to *set* switches from outside the image, use the SETENV command to change the status of program switches, as follows:

```
% setenv COBOL_SWITCHES "switch-list"
```

## Developing HP COBOL Programs 1.5 Using Program Switches

To *remove* switch settings:

```
% unsetenv COBOL_SWITCHES
```

To *check* switch settings, enter this command:

```
% printenv COBOL_SWITCHES          Shows switch settings.
```

The switch-list can contain up to 16 switches separated by commas. To set a switch on, specify it in the switch-list. A switch is off (the default) if you do not specify it in the switch-list.

For example:

```
% setenv COBOL_SWITCHES "1,5,13"   Sets switches 1, 5, and 13 ON.
```

```
% setenv COBOL_SWITCHES "9,11,16"  Sets switches 9, 11, and 16 ON.
```

```
% setenv COBOL_SWITCHES " "        Sets all switches OFF.
```

Following is a simple program that displays a message depending on the state of the environment variable COBOL\_SWITCHES (on Tru64 UNIX systems):

```
IDENTIFICATION DIVISION.  
PROGRAM-ID. TSW.  
  
ENVIRONMENT DIVISION.  
CONFIGURATION SECTION.  
SPECIAL-NAMES.  
    SWITCH 12 IS SW12 ON IS SW12-ON OFF IS SW12-OFF.  
  
PROCEDURE DIVISION.  
01-S.  
    DISPLAY "***TEST SWITCHES***".  
    IF SW12-ON  
        DISPLAY "SWITCH 12 IS ON".  
    IF SW12-OFF  
        DISPLAY "SWITCH 12 IS OFF".  
  
    DISPLAY "***END***".  
    STOP RUN.  
END PROGRAM TSW.
```

To test this program on a Tru64 UNIX system, compile and link it and then type the following:

```
% setenv COBOL_SWITCHES 12  
% tsw
```

The output is as follows:

```
**TEST SWITCHES**  
SWITCH 12 IS ON  
**END**          ◆
```

### Switches on OpenVMS

On OpenVMS systems, to set switches from outside the image or for a process, use the DCL DEFINE or ASSIGN command to change the status of program switches as follows:

```
$ DEFINE COB$SWITCHES "switch-list"
```

The switch-list can contain up to 16 switches separated by commas. To set a switch ON, specify it in the switch-list. A switch is OFF (the default) if you do not specify it in the switch-list.

## Developing HP COBOL Programs

### 1.5 Using Program Switches

For example:

```
$ DEFINE COB$SWITCHES "1,5,13"   Sets switches 1, 5, and 13 ON.
$ DEFINE COB$SWITCHES "9,11,16"  Sets switches 9, 11, and 16 ON.
$ DEFINE COB$SWITCHES " "        Sets all switches OFF.
```

The order of evaluation for logical name assignments is image, process, group, system. System and group assignments (including HP COBOL program switch settings) continue until they are changed or deassigned. Process assignments continue until they are changed, deassigned, or until the process ends. Image assignments end when they are changed or when the image ends.

You should know the system and group assignments for COB\$SWITCHES unless you have defined them for your process or image. To check switch settings, enter this command:

```
$ SHOW LOGICAL COB$SWITCHES
```

Use the DCL DEASSIGN command to remove the switch-setting logical name from your process and reactivate the group or system logical name (if any):

```
$ DEASSIGN COB$SWITCHES
```

To change the status of external switches during execution, follow these steps:

1. Interrupt the image with a STOP (literal-string) COBOL statement. (Refer to the *HP COBOL Reference Manual* for more information.)
2. Use the DCL DEFINE command to change switch settings.
3. Continue execution with the DCL CONTINUE command. Be sure not to force the interrupted image to exit by entering a command that executes another image.

For information about these DCL commands, refer to the *OpenVMS DCL Dictionary*.

Following is a simple program that displays a message depending on the state of the logical name COB\$SWITCHES (on OpenVMS systems):

```
IDENTIFICATION DIVISION.
PROGRAM-ID. TSW.

ENVIRONMENT DIVISION.
CONFIGURATION SECTION.
SPECIAL-NAMES.
    SWITCH 12 IS SW12 ON IS SW12-ON OFF IS SW12-OFF.

PROCEDURE DIVISION.
01-S.
    DISPLAY "***TEST SWITCHES***".
    IF SW12-ON
        DISPLAY "SWITCH 12 IS ON".
    IF SW12-OFF
        DISPLAY "SWITCH 12 IS OFF".

    DISPLAY "***END***".
    STOP RUN.
END PROGRAM TSW.
```

On OpenVMS, to test the previous program, compile and link it and then type the following:

```
$ DEFINE COB$SWITCHES 12
$ RUN TSW
```

The output is as follows:

```
**TEST SWITCHES**  
SWITCH 12 IS ON  
**END**      ◆
```

## 1.6 Special Information for Year 2000 Programming

Even subsequent to the turn of the millennium, there still exist potential disruptions in previously problem-free software where there are instances of a two-digit year field that should be a four-digit field. Programmers need to correct all such fields, as Hewlett-Packard cannot prevent problems that originate in application code.

Two-digit year formats used in controlling fields, or as keys in indexed files, can cause program logic to become ambiguous. It is a fundamental rule to use four-digit years instead of two-digit years in areas where sequential operations are driven from these values or for comparison of these values.

HP COBOL provides programmer access to four-digit and two-digit year formats:

4-digit	FUNCTION CURRENT-DATE
4-digit	FUNCTION DATE-OF-INTEGGER
4-digit	FUNCTION DATE-TO-YYYYMMDD
4-digit	FUNCTION DAY-OF-INTEGGER
4-digit	FUNCTION DAY-TO-YYYYDDD
4-digit	FUNCTION INTEGER-OF-DATE
4-digit	FUNCTION INTEGER-OF-DAY
4-digit	FUNCTION TEST-DATE-YYYYMMDD
4-digit	FUNCTION TEST-DAY-YYYYDDD
4-digit	FUNCTION WHEN-COMPILED
4-digit	FUNCTION YEAR-TO-YYYY
2-digit	ACCEPT FROM DATE
2-digit	ACCEPT FROM DAY
4-digit	ACCEPT FROM DATE YYYYMMDD
4-digit	ACCEPT FROM DAY YYYYDDD

HP COBOL offers date functions that can be used in program logic that makes decisions about year order. The full four-digit year handled by the six functions listed should be used in internal program logic decisions that are based on years. External displays of year information can continue to use two-digit formats when that is appropriate.

You should check program logic in code that uses ACCEPT, to verify that millennium transition dates are properly handled.

The use of two-digit years in applications does not automatically create a problem, but a problem *could* exist. Programmers need to inspect each of their applications for two-digit year dependencies and change any such instances to check the full four-digit year value.



---

## Handling Numeric Data

**Numeric data** in HP COBOL is evaluated with respect to the algebraic value of the operands.

This chapter describes the following topics concerning numeric data handling:

- How the compiler stores numeric data (Section 2.1)
- Specifying alignment (Section 2.2)
- Sign conventions (Section 2.3)
- Invalid values in numeric items (Section 2.4)
- Evaluating numeric items (Section 2.5)
- Using the MOVE statement (Section 2.6)
- Using the arithmetic statements (Section 2.7)

### 2.1 How the Compiler Stores Numeric Data

Understanding how data is stored will help you in the following situations:

- When you define data items to participate in group moves or to be the subject of a REDEFINES clause
- When you move a complex record consisting of several levels of subordination, to be sure that the receiving item is large enough to prevent data truncation
- When you need to use data storage concepts to minimize storage space, particularly when the data file is large

The storage considerations applicable to tables are described in Chapter 4.

For each numeric data item, HP COBOL stores the numeric value, and a sign (if an S appears in the PICTURE clause).

The USAGE clause of a numeric data item specifies the data's internal format in storage. When you do not specify a USAGE clause, the default usage is DISPLAY. For further information about internal representations, refer to the USAGE clause tables in the *HP COBOL Reference Manual*.

### 2.2 Specifying Alignment

In HP COBOL, all records, and elementary items with level 01 or 77, begin at an address that is a multiple of 8 bytes (a quadword boundary). By default, the HP COBOL compiler will locate a subordinate data item at the next unassigned byte location. However, the SYNCHRONIZED clause, the -align flag (on Tru64 UNIX), the /ALIGNMENT qualifier (on OpenVMS Alpha and I64), and alignment directives can be used to modify this behavior, causing some numeric data items to be aligned on a 2-, 4-, or 8-byte boundary. You can thus tune data alignment for optimum performance, compatibility with HP COBOL for

## Handling Numeric Data

### 2.2 Specifying Alignment

OpenVMS VAX, or flexibility. (See Chapter 16, Managing Memory and Data Access and Chapter 15, Optimizing Your HP COBOL Program in this manual, and refer to the SYNCHRONIZED clause in the *HP COBOL Reference Manual* for a complete discussion of alignment.)

### 2.3 Sign Conventions

HP COBOL numeric items can be signed or unsigned. Note the following sign conventions:

- If you store a signed result in an unsigned item, only the absolute value is stored. Thus, unsigned items only contain the value zero or a positive value.
- The way HP COBOL stores signed results in signed data items depends on the usage and the presence or absence of the SIGN clause.
- When an unsigned result is stored in a signed data item, the sign of the stored result is positive.

Do not use unsigned numeric items in arithmetic operations. They usually cause programming errors and are handled less efficiently than signed numeric items. The following example shows how unsigned numeric items can cause errors:

```
DATA DIVISION
.
.
.
01 A PIC 9(5) COMP VALUE 2.
01 B PIC 9(5) COMP VALUE 5.
```

Then:

```
SUBTRACT B FROM A.      (A = 3)
SUBTRACT 1 FROM A.     (A = 2)
```

However:

```
COMPUTE A = (A - B) - 1   (A = 4)
```

The absence of signs for the numeric items A and B results in two different answers after parallel arithmetic operations have been done. This occurs because internal temporaries (required by the COMPUTE statement) are signed. Thus, the result of (A-B) within the COMPUTE statement is -3; -3 minus 1 is -4 and the value of A then becomes 4.

### 2.4 Invalid Values in Numeric Items

All HP COBOL arithmetic operations store valid values in their result items. However, it is possible, through group moves or REDEFINES, to store data in numeric items that do not conform to the data definitions of those items.

The results of arithmetic operations that use invalid data in numeric items are undefined. You can use the -check decimal flag (on the Tru64 UNIX operating system) or the /CHECK=DECIMAL qualifier (on the OpenVMS Alpha or I64 operating systems) to validate numeric digits when using display numeric items in a numeric context; note that this flag or qualifier causes a program to terminate abnormally if there is invalid data. In the case of data with blanks (typically, records in a file), you can use the -convert leading\_blanks flag (on Tru64 UNIX) or the /CONVERT qualifier (on OpenVMS Alpha or I64) to change all blanks to zeroes before performing the arithmetic operation. If you specify both the -check decimal and the -convert leading\_blanks flags (on



Tru64 UNIX), or both the /CHECK=DECIMAL and the /CONVERT qualifiers on OpenVMS Alpha or I64, the conversion of blanks will be done prior to the validation of the resulting numeric digits. Note that the use of either or both of these qualifiers increases the execution time of the program. Refer to HP COBOL online help (at the OpenVMS system prompt), or man cobol (on Tru64 UNIX) for more information.

## 2.5 Evaluating Numeric Items

HP COBOL provides several kinds of conditional expressions used for evaluating numeric items. These conditional expressions include the following:

- The numeric relation condition that compares the item's contents to another numeric value
- The sign condition that examines the item's sign to see if it is positive or negative
- The class condition that inspects the item's digit positions for valid numeric characters
- The success/failure condition that checks the return status codes of COBOL and non-COBOL procedures for success or failure conditions

The following sections explain these conditional expressions in detail.

### 2.5.1 Numeric Relation Test

A numeric relation test compares two numeric quantities and determines if the specified relation between them is true. For example, the following statement compares item FIELD1 to item FIELD2 and determines if the numeric value of FIELD1 is greater than the numeric value of FIELD2:

```
IF FIELD1 > FIELD2 ...
```

If the relation condition is true, the program control takes the true path of the statement.

Table 2–1 describes the relational operators.

**Table 2–1 Numeric Relational Operator Descriptions**

Operator	Description
IS [NOT] GREATER THAN IS [NOT] >	The first operand is greater than (or not greater than) the second operand.
IS [NOT] LESS THAN IS [NOT] <	The first operand is less than (or not less than) the second operand.
IS [NOT] EQUAL TO IS [NOT] =	The first operand is equal to (or not equal to) the second operand.
IS GREATER THAN OR EQUAL TO IS >=	The first operand is greater than or equal to the second operand.
IS LESS THAN OR EQUAL TO IS <=	The first operand is less than or equal to the second operand.

Comparison of two numeric operands is valid regardless of their USAGE clauses.

## Handling Numeric Data

### 2.5 Evaluating Numeric Items

The length of the literal or arithmetic expression operands (in terms of the number of digits represented) is not significant. Zero is a unique value, regardless of the sign.

Unsigned numeric operands are assumed to be positive for comparison. The results of relation tests involving invalid (nonnumeric) data in a numeric item are undefined.

#### 2.5.2 Numeric Sign Test

The sign test compares a numeric quantity to zero and determines if it is greater than (positive), less than (negative), or equal to zero. Both the relation test and the sign test can perform this function. For example, consider the following relation test:

```
IF FIELD1 > 0 ...
```

Now consider the following sign test:

```
IF FIELD1 POSITIVE ...
```

Both of these tests accomplish the same thing and always arrive at the same result. The sign test, however, shortens the statement and makes it more obvious that the sign is being tested.

Table 2–2 shows the sign tests and their equivalent relation tests.

**Table 2–2 Sign Tests**

<b>Sign Test</b>	<b>Equivalent Relation Test</b>
IF FIELD1 POSITIVE ...	IF FIELD1 > 0 ...
IF FIELD1 NOT POSITIVE ...	IF FIELD1 NOT > 0 ...
IF FIELD1 NEGATIVE ...	IF FIELD1 < 0 ...
IF FIELD1 NOT NEGATIVE ...	IF FIELD1 NOT < 0 ...
IF FIELD1 ZERO ...	IF FIELD1 = 0 ...
IF FIELD1 NOT ZERO ...	IF FIELD1 NOT = 0 ...

Sign tests do not execute faster or slower than relation tests because the compiler substitutes the equivalent relation test for every correctly written sign test.

#### 2.5.3 Numeric Class Tests

The class test inspects an item to determine if it contains numeric or alphabetic data. For example, the following statement determines if FIELD1 contains numeric data:

```
IF FIELD1 IS NUMERIC ...
```

If the item is numeric, the test condition is true, and program control takes the true path of the statement.

Both relation and sign tests determine only if an item's contents are within a certain range. Therefore, certain items in newly prepared data can pass both the relation and sign tests and still contain data preparation errors.

The NUMERIC class test checks alphanumeric or numeric DISPLAY or COMP-3 usage items for valid numeric digits. If the item being tested contains a sign (whether carried as an overpunched character or as a separate character), the test checks it for a valid sign value. If the character position carrying the sign

contains an invalid sign value, the NUMERIC class test rejects the item, and program control takes the false path of the IF statement.

The ALPHABETIC class test check is not valid for an operand described as numeric.

#### 2.5.4 Success/Failure Tests

The success/failure condition tests the return status codes of COBOL and non-COBOL procedures for success or failure conditions. You test *status-code-id* as follows:

$$\text{status-code-id IS } \left\{ \begin{array}{c} \underline{\text{SUCCESS}} \\ \underline{\text{FAILURE}} \end{array} \right\}$$

You can use the SET statement to initialize or alter the status of *status-code-id* (which must be a word or longword COMP integer represented by PIC 9(1 to 9) COMP or PIC S9(1 to 9) COMP), as follows:

$$\underline{\text{SET}} \text{ status-code-id } \underline{\text{TO}} \left\{ \begin{array}{c} \underline{\text{SUCCESS}} \\ \underline{\text{FAILURE}} \end{array} \right\}$$

The SET statement is typically in the called program, but the calling program may also SET the status of *status-code-id*. The SUCCESS class condition is true if *status-code-id* has been set to SUCCESS, otherwise it is false. The FAILURE class condition is true if *status-code-id* has been set to FAILURE, otherwise it is false. The results are unspecified if status-code is not set.

Example 2-1 shows the significant COBOL code relevant to a success/failure test.

#### Example 2-1 Success/Failure Test

```
.....
PROGRAM-ID.  MAIN-PROG.
.....
01  RETURN-STATUS      PIC S9(9) COMP.
.....
    CALL "PROG-1" GIVING RETURN-STATUS.
    IF RETURN-STATUS IS FAILURE PERFORM FAILURE-ROUTINE.
.....
PROGRAM-ID.  PROG-1.
.....
WORKING-STORAGE SECTION.
01  RETURN-STATUS      PIC S9(9) COMP.
PROCEDURE DIVISION GIVING RETURN-STATUS.
.....
    IF NUM-1 = NUM-2
        SET RETURN-STATUS TO SUCCESS
    ELSE
        SET RETURN-STATUS TO FAILURE.
.....
    EXIT PROGRAM.
END PROGRAM PROG-1.
END PROGRAM MAIN-PROG.
```

## Handling Numeric Data

### 2.6 Using the MOVE Statement

## 2.6 Using the MOVE Statement

The MOVE statement moves the contents of one item into another item. The following sample MOVE statement moves the contents of item FIELD1 into item FIELD2:

```
MOVE FIELD1 TO FIELD2.
```

This section considers MOVE statements as applied to numeric and numeric edited data items.

### 2.6.1 Elementary Numeric Moves

If both items of a MOVE statement are elementary items and the receiving item is numeric, it is an elementary numeric move. The sending item can be numeric, alphanumeric, or numeric-edited. The elementary numeric move converts the data format of the sending item to the data format of the receiving item.

An alphanumeric sending item can be either of the following:

- An elementary alphanumeric data item
- Any alphanumeric literal other than the figurative constants SPACE, QUOTE, LOW-VALUE, or HIGH-VALUE

The elementary numeric move accepts the figurative constant ZERO and considers it to be equivalent to the numeric literal 0. It treats alphanumeric sending items as unsigned integers of DISPLAY usage.

When the sending item is numeric-edited, de-editing is applied to establish the unedited numeric value, which may be signed; then the unedited numeric value is moved to the receiving field.

If necessary, the numeric move operation converts the sending item to the data format of the receiving item and aligns the sending item's decimal point on that of the receiving item. Then it moves the sending item's digits to the corresponding receiving item's digits.

If the sending item has more digit positions than the receiving item, the decimal point alignment operation truncates the value of the sending item, with resulting loss of digits.

The end truncated (high-order or low-order) depends upon the number of sending item digit positions that find matches on each side of the receiving item's decimal point. If the receiving item has fewer digit positions on both sides of the decimal point, the operation truncates both ends of the sending item. Thus, if an item described as PIC 999V999 is moved to an item described as PIC 99V99, it loses one digit from the left end and one from the right end.

In the execution part of the following examples, the caret (^) indicates the assumed stored decimal point position:

```
01 AMOUNT1 PIC 99V99 VALUE ZEROS.
```

```
  .  
  .  
  .
```

```
  MOVE 123.321 TO AMOUNT1.
```

```
Before execution: 00^00
```

```
After execution:  23^32
```

## Handling Numeric Data 2.6 Using the MOVE Statement

If the sending item has fewer digit positions than the receiving item, the move operation supplies zeros for all unfilled digit positions.

```
01 TOTAL-AMT PIC 999V99 VALUE ZEROS.
```

```
  .  
  .  
  .
```

```
    MOVE 1 TO TOTAL-AMT.
```

```
Before execution:  000^00
```

```
After execution:   001^00
```

The following statements produce the same results:

```
MOVE 001.00 TO TOTAL-AMT.
```

```
MOVE "1" TO TOTAL-AMT.
```

Consider the following two MOVE statements and their truncating and zero-filling effects:

Statement	TOTAL-AMT After Execution
MOVE 00100 TO TOTAL-AMT	100^00
MOVE "00100" TO TOTAL-AMT	100^00

Literals with leading or trailing zeros have no advantage in space or execution speed in HP COBOL, and the zeros are often lost by decimal point alignment.

The MOVE statement's receiving item dictates how the sign will be moved. When the receiving item is a signed numeric item, the sign from the sending item is placed in it. If the sending item is unsigned, and the receiving item is signed, a positive sign is placed in the receiving item. If the sending item is signed and the receiving item is unsigned, the absolute value of the sending item is moved to the receiving item.

### 2.6.2 Elementary Numeric-Edited Moves

An elementary numeric move to a numeric-edited receiving item is considered an elementary numeric-edited move. The sending item of an elementary numeric-edited move can be numeric, numeric-edited, or alphanumeric. When the sending item is numeric-edited, de-editing is applied to establish the item's unedited numeric value, which may be signed; then the unedited numeric value is moved to the receiving field. Alphanumeric sending items in numeric-edited moves are considered unsigned DISPLAY usage integers.

A numeric-edited item PICTURE can contain 9, V, and P, but to qualify as numeric-edited, it must also contain one or more of the following editing symbols:

```
Z  
B  
Asterisk (*)  
Period (. )  
Plus sign (+)  
Minus sign (-)  
CR  
DB  
Currency symbol  
Slash (/)  
Comma (, )  
Zero (0)
```

## Handling Numeric Data

### 2.6 Using the MOVE Statement

For a complete description of these symbols, refer to the *HP COBOL Reference Manual*.

The numeric-edited move operation first converts the sending item to DISPLAY usage and aligns both items on their decimal point locations. The sending item is truncated or zero-filled until it has the same number of digit positions on both sides of the decimal point as the receiving item. The operation then moves the sending item to the receiving item, following the HP COBOL editing rules.

The rules allow the numeric-edited move operation to perform any of the following editing functions:

- Replace leading zeros with either spaces or asterisks.
- Float a currency sign and a plus or minus sign through suppressed zeros, inserting the sign at either end of the item.
- Insert zeros, spaces, slashes, and/or the symbols CR or DB.
- Insert commas and a decimal point (or decimal points and a comma if DECIMAL-POINT IS COMMA).

Table 2–3 illustrates several of these functions, which are invoked by the statement:

```
MOVE FLD-B TO TOTAL-AMT.
```

Assume that FLD-B is described as S9999V99. Note that the caret ( ^ ) indicates an assumed decimal point in Table 2–3. In all but two of the examples, the sign of FLD-B is leading separate. Trailing overpunch signs (the sign of the number encoded into the rightmost digit) are used in the other two FLD-B data examples.

**Table 2–3 Numeric Editing**

FLD-B	TOTAL-AMT	
	PICTURE String	Contents After MOVE
+0023^00	ZZZZ.99	23.00
-0023^00	ZZZZ.99	23.00
0085^9P	++++.99	-85.97
+1234^00	Z,ZZZ.99	1,234.00
+0012^34	,\$,\$,\$.99	\$12.34
+0000^34	,\$,\$9.99	\$0.34
+1234^00	\$\$,\$,\$.99	\$1,234.00
+0012^34	\$\$9,999.99	\$0,012.34
+0012^34	\$\$\$\$,\$,\$.99	\$12.34
+0000^00	\$\$\$\$,\$,\$.	
0012^3M	++++.99	-12.34
+0012^34	\$***,***.99	\$*****12.34
+1234^56	Z,ZZZ.99+	1,234.56+

(continued on next page)

**Table 2–3 (Cont.) Numeric Editing**

FLD-B	TOTAL-AMT	
	PICTURE String	Contents After MOVE
-6543^21	\$\$\$\$,\$\$.99DB	\$6,543.21DB <sup>1</sup>

<sup>1</sup>The output includes DB if a negative value is moved.

The currency symbol (\$) or other currency sign) and the editing sign control symbols (+ and –) are the only floating symbols. To float a symbol, enter a string of two or more occurrences of that symbol, one for each character position over which you want the symbol to float.

### 2.6.3 Subscripted Moves

Any item (other than a data item that is not subordinate to an OCCURS clause) of a MOVE statement can be subscripted, and the referenced item can be used to subscript another name in the same statement.

For additional information, see Section 3.6.4, Subscripted Moves in Chapter 3, Handling Nonnumeric Data.

### 2.6.4 Common Move Errors

Programmers most commonly make the following errors when writing MOVE statements:

- Placing an incorrect number of replacement characters in a numeric edited item
- Moving nonnumeric data into numeric items with group moves
- Trying to float the currency sign (\$) or plus (+) insertion characters past the decimal point to force zero values to appear as .00 instead of spaces (use \$\$\$.99 or .99)
- Forgetting that the currency sign (\$), plus sign (+), minus sign (–), CR, or DB insertion characters require one or two additional positions on the leftmost end that cannot be replaced by a digit (unlike the asterisk (\* ) insertion character, which can be completely replaced)

## 2.7 Using the Arithmetic Statements

The HP COBOL arithmetic statements allow programs to perform arithmetic operations on numeric data. Large values present various problems, and COBOL command qualifiers can help resolve or mitigate them. The following sections discuss these topics.

### 2.7.1 Temporary Work Items

HP COBOL allows numeric items and literals with up to 31 decimal digits on Alpha and I64, and up to 18 decimal digits on VAX. (See Section 2.7.2 for more specific information.) It is quite easy to construct arithmetic expressions that produce too many digits.

## Handling Numeric Data

### 2.7 Using the Arithmetic Statements

Most forms of the arithmetic statements perform their operations in temporary work locations, then move the results to the receiving items, aligning the decimal points and truncating or zero-filling the resultant values. The actual size of a temporary work item (also called an intermediate result item) varies for each statement; it is determined at compile time, based on the sizes of the operands used by the statement and the arithmetic operation being performed. Should the temporary work item exceed the maximum size, truncation occurs.

On Alpha and I64 systems, the maximum temporary work item size is 31 digits for standard arithmetic and for native CIT4 arithmetic, and is 38 digits for some operations using native float or native CIT3. ♦

On VAX systems, the situation is different. The temporary work item has two forms, a scaled integer form and a software floating-point form. The scaled integer form has a maximum size of 31 numeric digits for a program compiled with the `/INSTRUCTION_SET = DECIMAL_STRING` or `GENERIC` qualifier, and a maximum of 38 digits for `/INSTRUCTION_SET = NODECIMAL_STRING`. When the compiler determines that the size of the intermediate result exceeds the maximum scaled integer size, it uses a software floating-point intermediate item and keeps the most significant 18 digits (for all settings of the `/INSTRUCTION_SET` qualifier). ♦

Programs should not arbitrarily specify sizes significantly larger than the values actually anticipated for the lifetime of the application. Although the generous limits in HP COBOL are useful for many applications, specifying many more digits than needed is likely to add extra processing cycles and complexity that is wasteful.

#### 2.7.2 Standard and Native Arithmetic (Alpha, I64)

HP COBOL supports two modes of arithmetic, standard and native. Standard arithmetic is preferable for greater precision with large values and for compatibility with other standard implementations of COBOL. These considerations are sometimes overridden by the need for compatibility with earlier versions of HP COBOL or for compatibility with HP COBOL for OpenVMS VAX, in which case native arithmetic is the appropriate mode.

Native arithmetic has three submodes: `FLOAT`, `CIT3`, and `CIT4`. (`CIT` stands for COBOL Intermediate Temporary).

You can specify the arithmetic mode and submode with the two COBOL command-line qualifiers `/ARITHMETIC` (or `-arithmetic`) and `/MATH_INTERMEDIATE` (or `-math_intermediate`). The use of these qualifiers is described in this section.

##### 2.7.2.1 Using the `/MATH_INTERMEDIATE` Qualifier (Alpha, I64)

You can specify the intermediate data type to be used when the result of an arithmetic operation cannot be represented exactly. This data type affects the truncation of the intermediate result and the consequent precision. It also affects compatibility of arithmetic results with previous versions of COBOL and other implementations of COBOL.

The three options of the `/MATH_INTERMEDIATE` (or `-math_intermediate`) qualifier are `FLOAT` (the default), `CIT3`, and `CIT4`, as follows:



## Handling Numeric Data

### 2.7 Using the Arithmetic Statements

- FLOAT** Selects double-precision binary floating-point for the intermediate data type. Intermediate values are truncated to the most significant 53 bits, with an 11-bit exponent, resulting in approximately 15 decimal digits of precision. **FLOAT** is the default, and it provides for compatibility with earlier versions of HP COBOL, but not with HP COBOL for OpenVMS VAX. **FLOAT** has been used since Version 1.0 of HP COBOL on Alpha.
- CIT3** Selects Cobol Intermediate Temporary (design 3) for the intermediate data type. Intermediate values are truncated to the most significant 18 decimal digits, with a 2-digit exponent. **CIT3** provides for increased compatibility with HP COBOL for OpenVMS VAX; even with **CIT3**, however, there are still some differences, which are described in Section B.4.12.
- CIT4** Selects Cobol Intermediate Temporary (design 4) for the intermediate data type. Intermediate values are truncated to the most significant 32 decimal digits, with a 2-digit exponent. **CIT4** has the greatest compatibility with the draft ANSI Standard. **CIT4** is the option of choice for greatest precision and for conformance to future standards and compatibility with other implementations of COBOL. **CIT4** is strongly recommended for programs that use numeric items with more than 18 digits or that have complicated expressions.
- In addition to the precision difference, **CIT4** arithmetic has the same differences and restrictions as shown in Section B.4.12 for **CIT3** arithmetic.

The default is `/MATH_INTERMEDIATE=FLOAT` (or `-math_intermediate float`). If you specify `/ARITHMETIC=STANDARD` (discussed in Section 2.7.2.2), this will force `/MATH_INTERMEDIATE=CIT4`.

#### Example of Different Arithmetic Results (Alpha, I64)

The following example illustrates the different results that you can get with **FLOAT**, **CIT3**, and **CIT4**:

```
IDENTIFICATION DIVISION.
PROGRAM-ID. MUL31.
DATA DIVISION.
WORKING-STORAGE SECTION.
01 XD PIC S9(31) VALUE 3.
01 YD PIC S9(31) VALUE 258718314234781388692555698765.
01 ZD PIC S9(31).
PROCEDURE DIVISION.
0.
    MULTIPLY XD BY YD GIVING ZD
        ON SIZE ERROR DISPLAY "Size error raised"
        NOT ON SIZE ERROR DISPLAY ZD WITH CONVERSION.
```

The compiler relies on the number of digits implied by the pictures of decimal and integer operands. Here it assumes that **XD** has 31 digits and **YD** has 31 digits. The product could require 62 digits, which is larger than the largest fixed-point arithmetic type available to the compiler. Depending on the intermediate data type chosen, this program gets several different results.

MATH	ZD	Intermediate maintains the most significant
-----	-----	-----
<b>FLOAT</b>	776154942704344283789821739008	53 bits
<b>CIT3</b>	776154942704344164000000000000	18 digits
<b>CIT4</b>	776154942704344166077667096295	32 digits

## Handling Numeric Data

### 2.7 Using the Arithmetic Statements

#### Other Consequences of Intermediate Range Differences (Alpha, I64)

Because each intermediate data type has a different maximum magnitude, an arithmetic statement can raise the size error condition with one arithmetic mode but not with another.

For example, the value +0.999 999 999 999 999 999E+99 (spaces added for readability) is representable in any of the intermediate data types. By contrast, the larger value +0.999 999 999 999 999 999 9E+99 cannot be represented in a CIT3 intermediate data item. Such an operation would cause an overflow, raising the size error condition. This value is representable, however, in a FLOAT or CIT4 intermediate data item; the size error condition would not be raised.

The value 1.0E+99 cannot be represented in either CIT3 or CIT4 form, but is representable in FLOAT form.

Similarly, because each intermediate data type has a different minimum magnitude, an arithmetic statement can raise the size error condition for underflow with one arithmetic mode but not another. (Underflow does not raise the size error condition when FLOAT arithmetic is used.)

A literal also can be valid with one arithmetic mode but not with another, resulting in different HIGHTRUNC and LOWTRUNC informational diagnostics. When a literal cannot be represented in an intermediate data item, the value used is undefined.

Arithmetic expressions in nonarithmetic statements are also affected. Nonarithmetic statements, such as the IF statement, allow arithmetic expressions to be used, but do not provide a mechanism like the ON SIZE ERROR phrase to detect errors in evaluation. If such an error occurs, the behavior of the statement is unpredictable; in the case of an IF statement, result of the comparison is undefined.

Similar considerations apply in other contexts, such as the use of arithmetic expressions as subscript expressions or reference-modification components.

#### 2.7.2.2 Using the /ARITHMETIC Qualifier (Alpha, I64)

You can specify /ARITHMETIC=NATIVE or STANDARD (-arithmetic native or standard) on the COBOL command line to control whether native arithmetic or standard arithmetic is used to evaluate arithmetic operations and statements. These options have the following effects:

NATIVE	Arithmetic operations will produce results that are reasonably compatible with releases for HP COBOL for OpenVMS Alpha prior to Version 2.7 and also with HP COBOL for OpenVMS VAX.
STANDARD	Most common arithmetic operations will produce results that are predictable, reasonable, and portable. In this context, portable means that the results will be identical from implementation to implementation. /ARITHMETIC=STANDARD forces /MATH_INTERMEDIATE=CIT4 (described in Section 2.7.2.1).

The default is /ARITHMETIC=NATIVE (-arithmetic native).

#### Using the OPTIONS Paragraph (Alpha, I64)

An alternative way to specify native or standard arithmetic is to use the OPTIONS paragraph in the Identification Division of your HP COBOL program. There you can specify ARITHMETIC IS NATIVE or STANDARD. Refer to the *HP COBOL Reference Manual* for the syntax and details. ♦

### 2.7.3 Specifying a Truncation Qualifier

The `-trunc` flag (on Tru64 UNIX) or the `/[NO]TRUNCATE` qualifier (on OpenVMS) specifies how the HP COBOL compiler stores values in COMPUTATIONAL receiving items.

By default (assuming that the `-trunc` flag is turned off, or `/NOTRUNCATE` is set), HP COBOL truncates values according to the Alpha or I64 hardware storage unit (word, longword, or quadword) allocated to the receiving item.

If you specify `-trunc` or `/TRUNCATE`, the compiler truncates values according to the number of decimal digits specified by the PICTURE clause.

### 2.7.4 Using the ROUNDED Phrase

Rounding is an important option that you can use with arithmetic operations.

You can use the ROUNDED phrase with any HP COBOL arithmetic statement. Rounding takes place only when the ROUNDED phrase requests it, and then only if the intermediate result has low-order digits that cannot be stored in the result.

HP COBOL rounds off by adding a 5 to the leftmost truncated digit of the absolute value of the intermediate result before it stores that result.

Table 2–4 shows several ROUNDING examples.

**Table 2–4 ROUNDING**

PICTURE clause	Initial Value	
03 ITEMA PIC S9(5)V9999.	12345.2222	
03 ITEMB PIC S9(5)V99.	54321.11	
03 ITEMC PIC S9999.	1234	
03 ITEM D PIC S9999P.	0	
03 ITEME PIC S99V99 VALUE 9.	9.00	
03 ITEMF PIC S99V99 VALUE 24.	24.00	

Arithmetic Statement	Intermediate Result	ROUNDED Result Value
ADD ITEMA TO ITEMB ROUNDED.	066666.3322	66666.33
MULTIPLY ITEM C BY 2 GIVING ITEM D ROUNDED.	02468	02470 <sup>1</sup>
DIVIDE ITEME INTO ITEM F ROUNDED.	02.666	02.67
DIVIDE ITEME INTO ITEM F GIVING ITEM C ROUNDED.	02.666	0003

<sup>1</sup>The trailing 0 is implied by the P in the PICTURE clause.

#### 2.7.4.1 ROUNDED with REMAINDER

The remainder computation uses an intermediate field that is truncated, rather than rounded, when you use the DIVIDE statement with both the ROUNDED and REMAINDER options.

## Handling Numeric Data

### 2.7 Using the Arithmetic Statements

#### 2.7.5 Using the SIZE ERROR Phrase

The SIZE ERROR phrase detects the loss of high-order nonzero digits in the results of HP COBOL arithmetic operations. It does this by checking the absolute value of an arithmetic result against the PICTURE character-string of each resultant identifier. For example, if the absolute value of the result is 100.05, and the PICTURE character-string of the resultant identifier is 99V99, the SIZE ERROR phrase detects that the high-order digit, 1, will be lost, and the size error condition will be raised.

You can use the phrase in any HP COBOL arithmetic statement.

When the execution of a statement with no ON SIZE ERROR phrase results in a size error, and native arithmetic is used, the values of all resultant identifiers are undefined. When standard arithmetic is used, or when the same statement includes an ON SIZE ERROR phrase, receiving items for which the size error exists are left unaltered; the result is stored in those receiving items for which no size error exists. The ON SIZE ERROR imperative phrase is then executed.

If the statement contains both ROUNDED and SIZE ERROR phrases, the result is rounded before a size error check is made.

The SIZE ERROR phrase cannot be used with numeric MOVE statements. Thus, if a program moves a numeric quantity to a smaller numeric item, it can lose high-order digits. For example, consider the following move of an item to a smaller item:

```
01 AMOUNT-A PIC S9(8)V99.  
01 AMOUNT-B PIC S9(4)V99.  
.  
.  
.  
MOVE AMOUNT-A TO AMOUNT-B.
```

This MOVE operation always loses four of AMOUNT-A's high-order digits. The statement can be tailored in one of three ways, as shown in the following example, to determine whether these digits are zero or nonzero:

1. IF AMOUNT-A NOT > 9999.99  
MOVE AMOUNT-A TO AMOUNT-B  
ELSE ...
2. ADD ZERO AMOUNT-A GIVING AMOUNT-B  
ON SIZE ERROR ...
3. COMPUTE AMOUNT-B = AMOUNT-A  
ON SIZE ERROR ...

All three alternatives allow the MOVE operation to occur only if AMOUNT-A loses no significant digits. If the value in AMOUNT-A is too large, all three avoid altering AMOUNT-B and take the alternate execution path.

You can also use a NOT ON SIZE ERROR phrase to branch to, or perform, sections of code only when no size error occurs.

#### 2.7.6 Using the GIVING Phrase

The GIVING phrase moves the intermediate result of an arithmetic operation to a receiving item. The phrase acts exactly like a MOVE statement in which the intermediate result serves as the sending item, and the data item following the word GIVING serves as the receiving item. When a statement contains a GIVING phrase, you can have a numeric-edited receiving item.

The receiving item can also have the ROUNDED phrase. If the receiving item is also numeric-edited, rounding takes place before the editing.

The GIVING phrase can be used with the ADD, SUBTRACT, MULTIPLY, and DIVIDE statements. For example:

ADD A,B GIVING C.

### 2.7.7 Multiple Operands in ADD and SUBTRACT Statements

Both the ADD and SUBTRACT statements can contain a series of operands preceding the word TO, FROM, or GIVING.

If there are multiple operands in either of these statements, the operands are added together. The intermediate result of that operation becomes a single operand to be added to or subtracted from the receiving item. In the following examples, TEMP is an intermediate result item:

1. Statement:                    ADD A,B,C,D, TO E,F,G,H.  
   Equivalent coding:        ADD A, B, GIVING TEMP.  
                              ADD TEMP, C, GIVING TEMP.  
                              ADD TEMP, D, GIVING TEMP.  
                              ADD TEMP, E, GIVING E.  
                              ADD TEMP, F, GIVING F.  
                              ADD TEMP, G, GIVING G.  
                              ADD TEMP, H, GIVING H.
2. Statement:                    SUBTRACT A, B, C, FROM D.  
   Equivalent coding:        ADD A, B, GIVING TEMP.  
                              ADD TEMP, C, GIVING TEMP.  
                              SUBTRACT TEMP FROM D, GIVING D.
3. Statement:                    ADD A,B,C,D, GIVING E.  
   Equivalent coding:        ADD A,B, GIVING TEMP.  
                              ADD TEMP, C, GIVING TEMP.  
                              ADD TEMP, D, GIVING E.

As in all HP COBOL statements, the commas in these statements are optional.

### 2.7.8 Common Errors in Arithmetic Statements

Programmers most commonly make the following errors when using arithmetic statements:

- Using an alphanumeric item in an arithmetic statement. The MOVE statement allows data movement between alphanumeric items and certain numeric items, but arithmetic statements require that all items be numeric.
- Writing the ADD or SUBTRACT statements without the GIVING phrase, and attempting to put the result into a numeric-edited item.
- Subtracting a 1 from a numeric counter that was described as an unsigned quantity and then testing for a value less than zero.
- Forgetting that the MULTIPLY statement, without the GIVING phrase, stores the result back into the second operand (multiplier).
- Performing a series of calculations that generates an intermediate result larger than 18 digits when the final result will have 18 or fewer digits. You can prevent this problem by interspersing divisions with multiplications or by dropping nonsignificant digits after multiplying large numbers or numbers with many decimal places. Also, avoid use of the COMPUTE statement to keep from performing such calculations implicitly.

## Handling Numeric Data

### 2.7 Using the Arithmetic Statements

- Forgetting that when an arithmetic statement has multiple receiving items you must specify the `ROUNDED` phrase for each receiving item you want rounded.
- Forgetting that the `ON SIZE ERROR` phrase applies to all receiving items in an arithmetic statement containing multiple receiving items. Only those receiving items for which a size error condition is raised are left unaltered. The `ON SIZE ERROR` imperative statement is executed after all the receiving items are processed.
- Controlling a loop by adding to a numeric counter that was described as `PIC 9`, and then testing for a value of 10 or greater to exit the loop.
- Forgetting that `ROUNDING` is done before the `ON SIZE ERROR` test.

---

## Handling Nonnumeric Data

**Nonnumeric data** in HP COBOL is evaluated with respect to a specified collating sequence of the operands.

The following information is in this chapter:

- How the compiler stores nonnumeric data (Section 3.1)
- Data organization (Section 3.2)
- Special characters (Section 3.3)
- Testing nonnumeric items (Section 3.4)
- Data movement (Section 3.5)
- Using the MOVE statement (Section 3.6)

### 3.1 How the Compiler Stores Nonnumeric Data

COBOL programs hold their data in items whose sizes are described in their source programs. The size of these items is thus fixed during compilation for the lifespan of the resulting object program.

Items in a COBOL program belong to any of the following three data classes:

- Numeric—Can contain only numeric values.
- Alphabetic—Can contain only A to Z (uppercase or lowercase) and space characters.
- Alphanumeric—Can contain the following types of values:
  - All alphabetic
  - All numeric
  - A mixture of alphabetic and numeric
  - Any character from the ASCII character set

The data description of an item specifies which class that item belongs to.

Classes are further subdivided into categories. Alphanumeric items can be numeric edited, alphanumeric edited, or alphanumeric. Every elementary item, except for an index data item, belongs to one of the classes and its categories. The class of a group item is treated as alphanumeric regardless of the classes of subordinate elementary items.

If the data description of an alphanumeric item specifies that certain editing operations be performed on any value that is moved into it, that item is called an alphanumeric edited item.

As you read this chapter, keep in mind the distinction between the class or category of a data item and the actual value that the item contains.

## Handling Nonnumeric Data

### 3.1 How the Compiler Stores Nonnumeric Data

Sometimes the text refers to alphabetic, alphanumeric, and alphanumeric edited data items as nonnumeric data items to distinguish them from items that are specifically numeric.

Regardless of the class of an item, it is usually possible at run time to store an invalid value in the item. Thus, nonnumeric ASCII characters can be placed in an item described as numeric, and an alphabetic item can be loaded with nonalphabetic characters. Invalid values can cause errors in output or run-time errors.

### 3.2 Data Organization

An HP COBOL record consists of a set of data description entries that describe record characteristics; it must have an 01 or 77 level number. A data description entry can be either a group item or an elementary item.

All of the records used by HP COBOL programs (except for certain registers and switches) must be described in the source program's Data Division. The compiler allocates memory space for these items (except for Linkage Section items) and fixes their size at compilation time.

The following sections explain how the compiler sets up storage for group and elementary data items.

#### 3.2.1 Group Items

A group item is a data item that is followed by one or more elementary items or other group items, all of which have higher-valued level numbers than the group to which they are subordinate.

The size of a group item is the sum of the sizes of its subordinate elementary items. The compiler considers all group items to be alphanumeric DISPLAY items regardless of the class and usage of their subordinate elementary items.

#### 3.2.2 Elementary Items

An elementary item is a data item that has no subordinate data item.

The size of an elementary item is determined by the number of symbols that represent character positions contained in the PICTURE character-string. For example, consider this record description:

```
01 TRANREC.  
   03 FIELD-1 PIC X(7).  
   03 FIELD-2 PIC S9(5)V99.
```

Both elementary items require seven bytes of memory; however, item FIELD-1 contains seven alphanumeric characters while item FIELD-2 contains seven decimal digits, an operational sign, and an implied decimal point. Operations on such items are independent of the mapping of the item into memory words (32-bit words that hold four 8-bit bytes). An item can begin in the leftmost or rightmost byte of a word with no effect on the function of any operation that refers to that item. (However, the position of items in memory can have an effect on run-time performance.)

In effect, the compiler sees memory as a continuous array of bytes, not words. This becomes particularly important when you are defining a table using the OCCURS clause (see Chapter 4).



In HP COBOL, all records, and elementary items with level 01 or 77, begin at an address that is a multiple of 8 bytes (a quadword boundary). By default, the HP COBOL compiler will locate a subordinate data item at the next unassigned byte location.

Refer to Chapter 16, Chapter 15, and the SYNCHRONIZED clause in the *HP COBOL Reference Manual* for a complete discussion of alignment.

### 3.3 Special Characters

HP COBOL allows you to handle any of the 128 characters of the ASCII character set as alphanumeric data, even though many of the characters are control characters, which usually direct input/output devices. Generally, alphanumeric data manipulations attach no meaning to the 8th bit of an 8-bit byte. Thus, you can move and compare these control characters in the same manner as alphabetic and numeric characters.

---

**Note**

---

Some control characters have 0 in the high-order bit and are part of the ASCII character set, while others have 1 in the high order bit and are not part of the ASCII character set.

---

Although the object program can manipulate all ASCII characters, certain control characters cannot appear in nonnumeric literals because the compiler uses them to delimit the source text.

You can place special characters into items of the object program by defining symbolic characters in the SPECIAL-NAMES paragraph or by using the EXTERNAL clause. Refer to the *HP COBOL Reference Manual* for information on these two topics.

The ASCII character set listed in the *HP COBOL Reference Manual* indicates the decimal value for any ASCII character.

### 3.4 Testing Nonnumeric Items

The following sections describe the relation and class tests as they apply to nonnumeric items.

#### 3.4.1 Relation Tests of Nonnumeric Items

An IF statement with a relation condition can compare the value in a nonnumeric data item with another value and use the result to alter the flow of control in the program.

An IF statement with a relation condition compares two operands. Either of these operands can be an identifier or a literal, but they cannot both be literals. If the stated relation exists between the two operands, the relation condition is true.

When coding a relational operator, leave a space before and after each reserved word. When the reserved word NOT is present, the compiler considers it and the next key word or relational character to be a single relational operator defining the comparison. Table 3–1 shows the meanings of the relational operators.

## Handling Nonnumeric Data

### 3.4 Testing Nonnumeric Items

**Table 3–1 Relational Operator Descriptions**

Operator	Description
IS [NOT] GREATER THAN IS [NOT] >	The first operand is greater than (or not greater than) the second operand.
IS [NOT] LESS THAN IS [NOT] <	The first operand is less than (or not less than) the second operand.
IS [NOT] EQUAL TO IS [NOT] =	The first operand is equal to (or not equal to) the second operand.
IS GREATER THAN OR EQUAL TO IS >=	The first operand is greater than or equal to the second operand.
IS LESS THAN OR EQUAL TO IS <=	The first operand is less than or equal to the second operand.

#### 3.4.1.1 Classes of Data

HP COBOL allows comparison of both numeric class operands and nonnumeric class operands; however, it handles each class of data differently. For example, it allows a comparison of two numeric operands regardless of the formats specified in their respective USAGE clauses, but it requires that all other comparisons (including comparisons of any group items) be between operands with the same usage. It compares numeric class operands with respect to their algebraic values and nonnumeric (or numeric and nonnumeric) class operands with respect to a specified collating sequence. (See Section 2.5.1 for numeric comparisons.)

If only one of the operands is numeric, it must be an integer data item or an integer literal, and it must be DISPLAY usage. In these cases, the manner in which the compiler handles numeric operands depends on the nonnumeric operand, as follows:

- If the nonnumeric operand is an elementary item or a literal, the compiler treats the numeric operand as if it had been moved into an alphanumeric data item the same size as the numeric operand and then compared. This causes any operational sign, whether carried as a separate character or as an overpunched character, to be stripped from the numeric item so that it appears to be an unsigned quantity.

In addition, if the PICTURE character-string of the numeric item contains trailing P characters, indicating that there are assumed integer positions that are not actually present, they are filled with zero digits. Thus, an item with a PICTURE character-string of S9999PPP is moved to a temporary location where it is described as 9999999. If its value is 432J (–4321), the value in the temporary location will be 4321000. The numeric digits take part in the comparison.

- If the nonnumeric operand is a group item, the compiler treats the numeric operand as if it had been moved into a group item the same size as the numeric operand and then compared. This is equivalent to a group move.

The compiler ignores the description of the numeric item (except for length) and, therefore, includes in its length any operational sign, whether carried as a separate character or as an overpunched character. Overpunched characters are never ASCII numeric digits. They are characters ranging from A to R, left brace ({}), or right brace ({}). Thus, the sign and the digits, stored as ASCII bytes, take part in the comparison, and zeros are not supplied for P characters in the PICTURE character-string.

The compiler does not accept a comparison between a noninteger numeric operand and a nonnumeric operand. If you try to compare these two items, you receive a diagnostic message at compile time.

#### 3.4.1.2 Comparison Operations

If the two operands are acceptable, the compiler compares them character by character. The compiler starts at the first byte and compares the corresponding bytes until it either encounters a pair of unequal bytes or reaches the last byte of the longer operand.

If the compiler encounters a pair of unequal characters, it considers their relative position in the collating sequence. The operand with the character that is positioned higher in the collating sequence is the greater operand.

If the operands have different lengths, the comparison proceeds as though the shorter operand were extended on the right by sufficient ASCII spaces (decimal 32) to make both operands the same length.

If all character pairs are equal, the operands are equal.

#### 3.4.2 Class Tests for Nonnumeric Items

An IF statement with a class condition tests the value in a nonnumeric data item (USAGE DISPLAY only) to determine whether it contains numeric, alphabetic, or user-defined data and uses the result to alter the flow of control in the program. For example:

```
IF ITEM-1 IS NUMERIC...  
IF ITEM-2 IS ALPHABETIC...  
IF ITEM-3 IS NOT NUMERIC...
```

If the data item consists entirely of the ASCII characters 0 to 9, with or without the operational sign, the class condition is NUMERIC. If the item consists entirely of the ASCII characters A to Z (upper- or lowercase) and spaces, the class condition is ALPHABETIC.

The ALPHABETIC-LOWER test is true if the operand contains any combination of the lowercase alphabetic characters a to z, and the space. Otherwise the test is false.

The ALPHABETIC-UPPER test is true if the operand contains any combination of the uppercase alphabetical characters A to Z, and the space. Otherwise, the test is false.

You can also perform a class test on a data item that you define with the CLASS clause of the SPECIAL-NAMES paragraph.

A class test is true if the operand consists entirely of the characters listed in the definition of the CLASS-NAME in the SPECIAL-NAMES paragraph. Otherwise, the test is false.

When the reserved word NOT is present, the compiler considers it and the next key word as one class condition defining the class test to be executed. For example, NOT NUMERIC determines if an operand contains at least one nonnumeric character.

If the item being tested is described as a numeric data item, it can only be tested as NUMERIC or NOT NUMERIC. The NUMERIC test cannot examine either of the following:

- An item described as alphabetic

## Handling Nonnumeric Data

### 3.4 Testing Nonnumeric Items

- A group item containing elementary items whose data descriptions indicate the presence of operational signs

For further information on using class conditions with numeric items, refer to the *HP COBOL Reference Manual*.

### 3.5 Data Movement

Three HP COBOL statements (MOVE, STRING, and UNSTRING) perform most of the data movement operations required by business-oriented programs. The MOVE statement simply moves data from one item to another. The STRING statement concatenates a series of sending items into a single receiving item. The UNSTRING statement disperses a single sending item into multiple receiving items. Section 3.6 describes the MOVE statement. Chapter 5 describes STRING and UNSTRING.

The MOVE statement handles most data movement operations on character strings. However, it is limited in its ability to handle multiple items. For example, it cannot, by itself, concatenate a series of sending items into a single receiving item or disperse a single sending item into several receiving items.

Two MOVE statements will, however, bring the contents of two items together into a third (receiving) item if the receiving item has been subdivided with subordinate elementary items that match the two sending items in size. If other items are to be concatenated into the third item, and they differ in size from the first two items, then the receiving item requires additional subdivisions (through redefinition).

Example 3–1 demonstrates item concatenation using two MOVE statements.

#### Example 3–1 Item Concatenation Using Two MOVE Statements

```
01 SEND-1          PIC X(5) VALUE "FIRST".
01 SEND-2          PIC X(6) VALUE "SECOND".
01 RECEIVE-GROUP.
   05 REC-1        PIC X(5).
   05 REC-2        PIC X(6).
PROCEDURE DIVISION.
A00-BEGIN.
   MOVE SEND-1 TO REC-1.
   MOVE SEND-2 TO REC-2.
   DISPLAY RECEIVE-GROUP.
   STOP RUN.
```

The result of the concatenation follows:

```
FIRSTSECOND
```

Two MOVE statements can also disperse the contents of one sending item to several receiving items. The first MOVE statement moves the leftmost end of the sending item to a receiving item; then the second MOVE statement moves the rightmost end of the sending item to another receiving item. (The second receiving item must first be described with the JUSTIFIED clause.) Characters from the middle of the sending item cannot easily be moved to any receiving item without extensive redefinitions of the sending item or a reference modification loop (as with concatenation).

The `STRING` and `UNSTRING` statements handle concatenation and dispersion more easily than compound moves. Reference modification handles substring operations more easily than compound moves, `STRING`, or `UNSTRING`.

### 3.6 Using the `MOVE` Statement

The `MOVE` statement moves the contents of one item into another. For example:

```
MOVE FIELD1 TO FIELD2
MOVE CORRESPONDING FIELD1 TO FIELD2
```

`FIELD1` is the sending item name, and `FIELD2` is the receiving item name.

The first statement causes the compiler to move the contents of `FIELD1` into `FIELD2`. The two items need not be the same size, class, or usage; they can be either group or elementary items. If the two items are not the same length, the compiler aligns them on one end or the other. It also truncates or space-fills the other end. The movement of group items and nonnumeric elementary items is discussed in Section 3.6.1 and Section 3.6.2, respectively.

The `MOVE` statement alters the contents of every character position in the receiving item.

#### 3.6.1 Group Moves

If either the sending or receiving item is a group item, the compiler considers the move to be a group move. It treats both the sending and receiving items as if they were alphanumeric items.

If the sending item is a group item, and the receiving item is an elementary item, the compiler ignores the receiving item description except for the size description, in bytes, and any `JUSTIFIED` clause. It conducts no conversion or editing on the sending item's data.

#### 3.6.2 Elementary Moves

If both items of a `MOVE` statement are elementary items, their `PICTURE` character-strings control their data movement. If the receiving item was described as numeric or numeric edited, the rules for numeric moves control the data movement (see Section 2.6). Nonnumeric receiving items are alphanumeric, alphanumeric edited, or alphabetic.

Table 3–2 shows the valid and invalid nonnumeric elementary moves.

**Table 3–2 Nonnumeric Elementary Moves**

Sending Item Category	Receiving Item Category	
	Alphabetic	Alphanumeric Alphanumeric Edited
ALPHABETIC	Valid	Valid
ALPHANUMERIC	Valid	Valid

(continued on next page)

## Handling Nonnumeric Data

### 3.6 Using the MOVE Statement

**Table 3–2 (Cont.) Nonnumeric Elementary Moves**

Sending Item Category	Receiving Item Category	
	Alphabetic	Alphanumeric Alphanumeric Edited
ALPHANUMERIC EDITED	Valid	Valid
NUMERIC INTEGER (DISPLAY ONLY)	Invalid	Valid
NUMERIC EDITED	Invalid	Valid

In all valid moves, the compiler treats the sending item as though it had been described as PIC X(n). A JUSTIFIED clause in the sending item's description has no effect on the move. If the sending item's PICTURE character-string contains editing characters, the compiler uses them only to determine the item's size.

In valid nonnumeric elementary moves, the receiving item controls the movement of data. All of the following characteristics of the receiving item affect the move:

- Its size
- Editing characters in its description
- The JUSTIFIED RIGHT clause in its description

The JUSTIFIED clause and editing characters are mutually exclusive.

When an item that contains no editing characters or JUSTIFIED clause in its description is used as the receiving item of a nonnumeric elementary MOVE statement, the compiler moves the characters starting at the leftmost position in the item and proceeding, character by character, to the rightmost position. If the sending item is shorter than the receiving item, the compiler fills the remaining character positions with spaces. If the sending item is longer than the receiving item, truncation occurs on the right.

Numeric items used in nonnumeric elementary moves must be integers in DISPLAY format.

If the description of the numeric data item indicates the presence of an operational sign (either as a character or an overpunched character), or if there are P characters in its character-string, the compiler first moves the item to a temporary location. It removes the sign and fills out any P character positions with zero digits. It then uses the temporary value as the sending item as if it had been described as PIC X(n). The temporary value can be shorter than the original value if a separate sign was removed, or longer than the original value if P character positions were filled with zeros.

If the sending item is an unsigned numeric class item with no P characters in its character-string, the MOVE is accomplished directly from the sending item, and a temporary item is not required.

If the numeric sending item is shorter than the receiving item, the compiler fills the receiving item with spaces.

**3.6.2.1 Edited Moves**

This section explains the following insertion editing characters:

- B                    Blank insertion position
- 0                    Zero insertion position
- /                    Slash insertion position

When an item with an insertion editing character in its PICTURE character-string is the receiving item of a nonnumeric elementary MOVE statement, each receiving character position corresponding to an editing character receives the insertion byte value. Table 3–3 illustrates the use of such symbols with the following statement, where FIELD1 is described as PIC X(7):

```
MOVE FIELD1 TO FIELD2
```

**Table 3–3 Data Movement with Editing Symbols**

FIELD1	FIELD2	
	Character-String	Contents After MOVE
070476	XX/99/XX	07/04/76
04JUL76	99BAAAB99	04sJULs76
2351212	XXXBXXXX/XX/	235s1212/ss/
123456	0XB0XB0XB0X	01s02s03s04

Legend: s = space

Data movement always begins at the left end of the sending item and moves only to the byte positions described as A, 9, or X in the receiving item PICTURE character-string. When the sending item is exhausted, the compiler supplies space characters to fill any remaining character positions (not insertion positions) in the receiving item. If the receiving item is exhausted before the last character is moved from the sending item, the compiler ignores the remaining sending item characters.

Any necessary conversion of data from one form of internal representation to another takes place during valid elementary moves, along with any editing specified for, or de-editing implied by, the receiving data item.

**3.6.2.2 Justified Moves**

A JUSTIFIED RIGHT clause in the receiving item’s data description causes the compiler to reverse its usual data movement conventions. It starts with the rightmost characters of both items and proceeds from right to left. If the sending item is shorter than the receiving item, the compiler fills the remaining leftmost character positions with spaces. If the sending item is longer than the receiving item, truncation occurs on the left. Table 3–4 illustrates various PICTURE character-string situations for the following statement:

```
MOVE FIELD1 TO FIELD2
```

## Handling Nonnumeric Data

### 3.6 Using the MOVE Statement

**Table 3–4 Data Movement with the JUSTIFIED Clause**

FIELD1		FIELD2	
PICTURE Character-String	Contents	PICTURE Character-String (and JUST-Clause)	Contents After MOVE
		XX	AB
		XXXXXX	ABCss
XXX	ABC	XX JUST	BC
		XXXXXX JUST	ssABC

Legend: s = space

#### 3.6.3 Multiple Receiving Items

If you write a MOVE statement containing more than one receiving item, the compiler moves the same sending item value to each of the receiving items. It has essentially the same effect as a series of separate MOVE statements, all with the same sending item.

The receiving items need have no relationship to each other. The compiler checks the validity of each one independently and performs an independent move operation on each one.

Multiple receiving items on MOVE statements provide a convenient way to set many items equal to the same value, such as during initialization code at the beginning of a section of processing. For example:

```
MOVE SPACES TO LIST-LINE, EXCEPTION-LINE, NAME-FLD.
MOVE ZEROS TO EOL-FLAG, EXCEPT-FLAG, NAME-FLAG.
MOVE 1 TO COUNT-1, CHAR-PTR, CURSOR.
```

#### 3.6.4 Subscripted Moves

Any item (other than a data item that is not subordinate to an OCCURS clause) of a MOVE statement can be subscripted, and the referenced item can be used to subscript another name in the same statement.

For example, when more than one receiving item is named in the same MOVE statement, the order in which the compiler evaluates the subscripts affects the results of the move. Consider the following examples:

```
MOVE FIELD1(FIELD2) TO FIELD2 FIELD3.
```

In this example, the compiler evaluates FIELD1(FIELD2) only once, before it moves any data to the receiving items. It is as if the single MOVE statement were replaced with the following three statements:

```
MOVE FIELD1(FIELD2) TO TEMP.
MOVE TEMP TO FIELD2.
MOVE TEMP TO FIELD3.
```



## Handling Nonnumeric Data

### 3.6 Using the MOVE Statement

In the following example, the compiler evaluates FIELD3(FIELD2) immediately before moving the data into it, but after moving the data from FIELD1 to FIELD2:

```
MOVE FIELD1 TO FIELD2 FIELD3(FIELD2).
```

Thus, it uses the newly stored value of FIELD2 as the subscript value. It is as if the single MOVE statement were replaced with the following two statements:

```
MOVE FIELD1 TO FIELD2.
```

```
MOVE FIELD1 TO FIELD3(FIELD2).
```

#### 3.6.5 Common Nonnumeric Item MOVE Statement Errors

The compiler considers any MOVE statement that contains a group item (whether sending or receiving) to be a group move. If an elementary item contains editing characters or a numeric integer, these attributes of the receiving item have no effect on the action of a group move.

#### 3.6.6 Using the MOVE CORRESPONDING Statement for Nonnumeric Items

The MOVE CORRESPONDING statement allows you to move multiple items from one group item to another group item, using a single MOVE statement. Refer to the *HP COBOL Reference Manual* for rules concerning the CORRESPONDING phrase. When you use the CORRESPONDING phrase, the compiler performs an independent move operation on each pair of corresponding items from the operands and checks the validity of each. Example 3-2 shows the use of the MOVE CORRESPONDING statement.

#### Example 3-2 Sample Record Description Using the MOVE CORRESPONDING Statement

```
01 A-GROUP.                                01 B-GROUP.
  02 FIELD1.                                02 FIELD1.
    03 A PIC X.                              03 A PIC X.
    03 B PIC 9.                              03 C PIC XX.
    03 C PIC XX.                             03 E PIC XXX.
    03 D PIC 99.
    03 E PIC XXX.

MOVE CORRESPONDING
  A-GROUP TO B-GROUP.
```

Equivalent MOVE statements:

```
MOVE A OF A-GROUP TO A OF B-GROUP.
```

```
MOVE C OF A-GROUP TO C OF B-GROUP.
```

```
MOVE E OF A-GROUP TO E OF B-GROUP.
```

## Handling Nonnumeric Data

### 3.6 Using the MOVE Statement

#### 3.6.7 Using Reference Modification

You can use reference modification to define a subset of a data item by specifying its leftmost character position and length. Reference modification is valid anywhere an alphanumeric identifier is allowed unless specific rules for a general format prohibit it. The following is an example of reference modification:

```
WORKING-STORAGE SECTION.  
01 ITEMA PIC X(10) VALUE IS "XYZABCDEFGH".  
   .  
   .  
   .  
   MOVE ITEMA(4:3) TO...
```

IDENTIFIER	VALUE
ITEMA (4:3)	ABC

For more information on reference modification rules, refer to the *HP COBOL Reference Manual*.

A **table** is one or more repetitions of one element, composed of one or more data items, stored in contiguous memory locations.

In this chapter you will find:

- Defining tables (Section 4.1)
- Initializing values of table elements (Section 4.2)
- Accessing table elements (Section 4.3)

## 4.1 Defining Tables

You define a table by using an OCCURS clause following a data description entry. The literal integer value you specify in the OCCURS clause determines the number of repetitions, or occurrences, of the data description entry, thus creating a table. HP COBOL allows you to define from 1- to 48-dimension tables.

After you have defined a table, you can load it with data. One way to load a table is to use the INITIALIZE statement or the VALUE clause to assign values to the table when you define it (see Figure 4–10).

To access data stored in tables, use subscripted or indexed procedural instructions. In either case, you can directly access a known table element occurrence or search for an occurrence based on some known condition.

You can define either fixed-length tables or variable-length tables, and they may be single or multidimensional. The following sections describe how to use the OCCURS clause and its options. For more information on tables and subscripting, refer to the *HP COBOL Reference Manual*.

### 4.1.1 Defining Fixed-Length, One-Dimensional Tables

To define fixed-length tables, use Format 1 of the OCCURS clause (refer to the *HP COBOL Reference Manual*). This format is useful when you are storing large amounts of stable or frequently used reference data. Options allow you to define single or multiple keys, or indexes, or both.

A definition of a one-dimensional table is shown in Example 4–1. The integer 2 in the OCCURS 2 TIMES clause determines the number of element repetitions. For the table to have any real meaning, this integer must be equal to or greater than 2.

## Handling Tables

### 4.1 Defining Tables

#### Example 4–1 One-Dimensional Table

```
01 TABLE-A.  
05 ITEM-B PIC X OCCURS 2 TIMES.
```

The organization of TABLE-A is shown in Figure 4–1.

**Figure 4–1 Organization of the One-Dimensional Table in Example 4–1**

Longword number	1			
Byte number	1	2	3	4
Level 01	A			
Level 05	B	B		

Legend: A = TABLE-A  
B = ITEM-B

ZK-6039-GE

Example 4–1 specifies only a single data item. However, you can specify as many data items as you need in the table. Multiple data items are shown in Example 4–2.

#### Example 4–2 Multiple Data Items in a One-Dimensional Table

```
01 TABLE-A.  
05 GROUP-B OCCURS 2 TIMES.  
10 ITEMC PIC X.  
10 ITEM D PIC X.
```

The organization of this table is shown in Figure 4–2.

**Figure 4–2 Organization of Multiple Data Items in a One-Dimensional Table**

Longword number	1			
Byte number	1	2	3	4
Level 01	A			
Level 05	B		B	
Level 10	C	D	C	D

Legend: A = TABLE-A                      C = ITEM C  
           B = GROUP-B                      D = ITEM D

ZK-6040-GE

Example 4–1 and Example 4–2 both do not use the **KEY IS** or **INDEXED BY** optional phrases. The **INDEXED BY** phrase implicitly defines an index name. This phrase must be used if any Procedure Division statements contain indexed references to the data name that contains the **OCCURS** clause. The **KEY IS** phrase means that repeated data is arranged in ascending or descending order according to the values in the data items that contain the **OCCURS** clause. (The **KEY IS** phrase does not cause the data in the table to be placed in ascending or descending order; rather, it allows you to state how you have arranged the data.) For further information about these **OCCURS** clause options, refer to the *HP COBOL Reference Manual*.

If you use either the **SEARCH** or the **SEARCH ALL** statement, you must specify at least one index. The **SEARCH ALL** statement also requires that you specify at least one key. Specify the search key using the **ASCENDING/DESCENDING KEY IS** phrase. (See Section 4.3.8 for information about the **SEARCH** statement and Section 4.3.4 for information about indexing.) When you use the **INDEXED BY** phrase, the index is internally defined and cannot be defined elsewhere. Example 4–3 defines a table with an ascending search key and an index.

**Example 4–3 Defining a Table with an Index and an Ascending Search Key**

```
01 TABLE-A.
   05 ELEMENTB OCCURS 5 TIMES
       ASCENDING KEY IS ITEM C
       INDEXED BY INDX1.
   10 ITEM C PIC X.
   10 ITEM D PIC X.
```

## Handling Tables

### 4.1 Defining Tables

The organization of this table is shown in Figure 4-3.

**Figure 4-3 Organization of a Table with an Index and an Ascending Search Key**

Longword number	1				2				3	
Byte number	0	0	0	0	0	0	0	0	0	1
	1	2	3	4	5	6	7	8	9	0
Level 01	TABLE-A									
Level 05	B	B	B	B	B	B	B	B	B	B
Level 10	C	D	C	D	C	D	C	D	C	D

Legend: B = ELEMENTB  
 C = ITEM C  
 D = ITEM D

ZK-6041-GE

#### 4.1.2 Defining Fixed-Length, Multidimensional Tables

HP COBOL allows 48 levels of OCCURS nesting. If you want to define a two-dimensional table, you define another one-dimensional table within each element of the one-dimensional table. To define a three-dimensional table, you define another one-dimensional table within each element of the two-dimensional table, and so on.

A two-dimensional table is shown in Example 4-4.

##### Example 4-4 Defining a Two-Dimensional Table

```
01 2D-TABLE-X.
   05 LAYER-Y OCCURS 2 TIMES.
      10 LAYER-Z OCCURS 2 TIMES.
         15 CELLA PIC X.
         15 CELLB PIC X.
```

The organization of this two-dimensional table is shown in Figure 4-4.

Example 4-5 shows a three-dimensional table.

The organization of this three-dimensional table is shown in Figure 4-5.

Figure 4-4 Organization of a Two-Dimensional Table

Longword number	1				2			
Byte number	1	2	3	4	5	6	7	8
Level 01	2D-TABLE-X							
Level 05	LY				LY			
Level 10	LZ	LZ	LZ	LZ	LZ	LZ	LZ	LZ
Level 15	A	B	A	B	A	B	A	B

Legend: LY = LAYER-Y                    A = CELLA  
           LZ = LAYER-Z                    B = CELLB

ZK-6042-GE

Example 4-5 Defining a Three-Dimensional Table

```
01 TABLE-A.
   05 LAYER-B OCCURS 2 TIMES.
      10 ITEMC PIC X.
      10 ITEMD PIC X OCCURS 3 TIMES.
      10 ITEME OCCURS 2 TIMES.
         15 CELLF PIC X.
         15 CELLG PIC X OCCURS 3 TIMES.
```

Figure 4-5 Organization of a Three-Dimensional Table

Longword number	1				2				3			4				5			6									
Byte number	0	0	0	0	0	0	0	0	0	1	1	1	1	1	1	1	1	1	1	2	2	2	2	2	2	2	2	
	1	2	3	4	5	6	7	8	9	0	1	2	3	4	5	6	7	8	9	0	1	2	3	4				
Level 01	A																											
Level 05	B												B															
Level 10	C	D	D	D	E				E				C	D	D	D	E				E							
Level 15					F	G	G	G	F	G	G	G					F	G	G	G	F	G	G	G				

Legend: A = TABLE-A                    E = ITEME  
           B = LAYER-B                    F = CELLF  
           C = ITEMC                        G = CELLG  
           D = ITEMD

ZK-6043-GE

### 4.1.3 Defining Variable-Length Tables

To define a variable-length table, use Format 2 of the OCCURS clause (refer to the *HP COBOL Reference Manual*). Options allow you to define single or multiple keys, or indexes, or both.

Example 4-6 illustrates how to define a variable-length table.

## Handling Tables

### 4.1 Defining Tables

It uses from two to four occurrences depending on the integer value assigned to NUM-ELEM. You specify the table's minimum and maximum size with the OCCURS (minimum size) TO (maximum size) clause. The minimum size value must be equal to or greater than zero and the maximum size value must be greater than the minimum size value. The DEPENDING ON clause is also required when you use the TO clause.

The data-name of an elementary, unsigned integer data item is specified in the DEPENDING ON clause. Its value specifies the current number of occurrences. The data-name in the DEPENDING ON clause must be within the minimum to maximum range.

Unlike fixed-length tables, you can dynamically alter the number of element occurrences in variable-length tables.

By generating the variable-length table in Example 4–6, you are, in effect, saying: “Build a table that can contain at least two occurrences, but no more than four occurrences, and set its present number of occurrences equal to the value specified by NUM-ELEM.”

#### Example 4–6 Defining a Variable-Length Table

```
01 NUM-ELEM PIC 9.  
    .  
    .  
01 VAR-LEN-TABLE.  
    05 TAB-ELEM OCCURS 2 TO 4 TIMES DEPENDING ON NUM-ELEM.  
       10 A PIC X.  
       10 B PIC X.
```

#### 4.1.4 Storage Allocation for Tables

The compiler maps the table elements into memory, following mapping rules that depend on the use of COMP, COMP-1, COMP-2, POINTER, and INDEX data items in the table element, the presence or absence of the SYNCHRONIZED (SYNC) clause with those data items, and the -align flag (on the Tru64 UNIX operating system) or the /ALIGNMENT qualifier (on the OpenVMS Alpha and I64 operating systems).

The HP COBOL compiler allocates storage for data items within records according to the rules of the Major-Minor Equivalence technique. This technique ensures that identically defined group items have the same structure, even when their subordinate items are aligned. Therefore, group moves always produce predictable results. For more information, refer to the description of record allocation in the *HP COBOL Reference Manual*.

---

#### Note

---

To determine exactly how much space your tables use, specify the -map flag (on Tru64 UNIX), or the /MAP qualifier (on OpenVMS). This gives you an offset map of both the Data Division and the Procedure Division.

---



Example 4–7 shows how to describe a sample record in a table.

**Example 4–7 Sample Record Description Defining a Table**

```
01 TABLE-A.
   03 GROUP-G PIC X(5) OCCURS 5 TIMES.
```

Figure 4–6 shows how the table defined in Example 4–7 is mapped into memory.

**Figure 4–6 Memory Map for Example 4–7**

Longword number	1				2				3				4				5				6				7			
Byte number	0	0	0	0	0	0	0	0	0	1	1	1	1	1	1	1	1	1	1	2	2	2	2	2	2	2	2	2
Level 01	TABLE-A																											
Level 03	GROUP-G				GROUP-G				GROUP-G				GROUP-G				GROUP-G											

ZK-6050-GE

Alphanumeric data items require 1 byte of storage per character. Therefore, each occurrence of GROUP-G occupies 5 bytes. The first byte of the first element is automatically aligned at the left record boundary and the first 5 bytes occupy all of word 1 and part of 2. A memory longword is composed of 4 bytes. Succeeding occurrences of GROUP-G are assigned to the next 5 adjacent bytes so that TABLE-A is composed of five 5-byte elements for a total of 25 bytes. Each table element, after the first, is allowed to start in any byte of a word with no regard for word boundaries.

**4.1.4.1 Using the SYNCHRONIZED Clause**

By default, the HP COBOL compiler tries to allocate a data item at the next unassigned byte location. However, you can align some data items on a 2-, 4-, or 8-byte boundary by using the SYNCHRONIZED clause. The compiler may then have to skip one or more bytes before assigning a location to the next data item. The skipped bytes, called fill bytes, are gaps between one data item and the next.

The SYNCHRONIZED clause explicitly aligns COMP, COMP-1, COMP-2, POINTER, and INDEX data items on their natural boundaries: one-word COMP items on 2-byte boundaries, longword items on 4-byte boundaries, and quadword items on 8-byte boundaries. Thus the use of SYNC can have a significant effect on the amount of memory required to store tables containing COMP and COMP SYNC data items.

**Note**

The examples in this section assume compilation without the -align flag (on Tru64 UNIX systems) or the /ALIGNMENT qualifier (on Alpha and I64 systems).

# Handling Tables

## 4.1 Defining Tables

### Example 4–8 Record Description Containing a COMP SYNC Item

```

01 A-TABLE.
   03 GROUP-G OCCURS 4 TIMES.
     05 ITEM1 PIC X.
     05 ITEM2 PIC S9(5) COMP SYNC.

```

Figure 4–7 Memory Map for Example 4–8

Longword number	1			2				3			4				5				6				7				8					
Byte number	0	0	0	0	0	0	0	0	1	1	1	1	1	1	1	1	2	2	2	2	2	2	2	2	2	2	2	3	3	3		
	1	2	3	4	5	6	7	8	9	0	1	2	3	4	5	6	7	8	9	0	1	2	3	4	5	6	7	8	9	0	1	2
Level 01	A-TABLE																															
Level 03	GROUP-G								GROUP-G								GROUP-G								GROUP-G							
Level 05	1	f	f	f	2	2	2	2	1	f	f	f	2	2	2	2	1	f	f	f	2	2	2	2	1	f	f	f	2	2	2	2

Legend: 1 = ITEM1  
 2 = ITEM2  
 f = fill byte

ZK-6044-GE

Example 4–8 describes a table containing a COMP SYNC data item. Figure 4–7 illustrates how it is mapped into memory.

Because a 5-digit COMP SYNC item requires one longword (or 4 bytes) of storage, ITEM2 must start on a longword boundary. This requires the addition of 3 fill bytes after ITEM1, and each GROUP-G occupies 8 bytes. In Example 4–8, A-TABLE requires 32 bytes to store four elements of 8 bytes each.

If, in the previous example, you define ITEM2 as a COMP data item of the same size without the SYNC clause, the storage required will be considerably less. Although ITEM2 will still require one longword of storage, it will be aligned on a byte boundary. No fill bytes will be needed between ITEM1 and ITEM2, and A-TABLE will require a total of 20 bytes.

If you now add a 3-byte alphanumeric item (ITEM3) to Example 4–8 and locate it between ITEM1 and ITEM2 (see Example 4–9), the new item occupies the space formerly occupied by the 3 fill bytes. This adds 3 data bytes without changing the table size, as Figure 4–8 illustrates.

### Example 4–9 Adding an Item Without Changing the Table Size

```

01 A-TABLE.
   03 GROUP-G OCCURS 4 TIMES.
     05 ITEM1 PIC X.
     05 ITEM3 PIC XXX.
     05 ITEM2 PIC 9(5) COMP SYNC.

```

Figure 4–8 Memory Map for Example 4–9

Longword number	1				2				3				4				5				6				7				8			
Byte number	0	0	0	0	0	0	0	0	0	1	1	1	1	1	1	1	1	1	1	2	2	2	2	2	2	2	2	2	2	3	3	3
Level 01	A-TABLE																															
Level 03	GROUP-G								GROUP-G								GROUP-G								GROUP-G							
Level 05	1	3	3	3	2	2	2	2	1	3	3	3	2	2	2	2	1	3	3	3	2	2	2	2	1	3	3	3	2	2	2	2

Legend: 1 = ITEM1  
2 = ITEM2  
3 = ITEM3

ZK-6045-GE

Example 4–10 How Adding 3 Bytes Adds 4 Bytes to the Element Length

```
01 A-TABLE.
03 GROUP-G OCCURS 4 TIMES.
05 ITEM1 PIC X.
05 ITEM2 PIC 9(5) COMP SYNC.
05 ITEM3 PIC XXX.
```

Figure 4–9 Memory Map for Example 4–10

Longword number	1				2				3				4				5				6				...								
Byte number	0	0	0	0	0	0	0	0	0	1	1	1	1	1	1	1	1	1	1	2	2	2	2	2	2	3	3	3	...				
Level 01	A-TABLE																																...
Level 03	GROUP-G								GROUP-G								...																
Level 05	1	f	f	f	2	2	2	2	3	3	3	f	1	f	f	f	2	2	2	2	3	3	3	f	...								

Legend: 1 = ITEM1  
2 = ITEM2  
3 = ITEM3  
f = fill byte

ZK-6046-GE

If, however, you place ITEM3 after ITEM2, the additional 3 bytes add their own length plus another fill byte. The additional fill byte is added after the third ITEM3 character to ensure that all occurrences of the table element are mapped in an identical manner. Now, each element requires 12 bytes, and the complete table occupies 48 bytes. This is illustrated by Example 4–10 and Figure 4–9.

Note that GROUP-G begins on a 4-byte boundary because of the way HP COBOL allocates memory.

## Handling Tables

### 4.2 Initializing Values of Table Elements

#### 4.2 Initializing Values of Table Elements

You can initialize a table that contains only DISPLAY items to any desired value in either of the following ways:

- You can specify a VALUE clause in the record level preceding the record description of the item containing the OCCURS clause.
- You can specify a VALUE clause in a record subordinate to the OCCURS clause.

Example 4–11 and Figure 4–10 provide an example and memory map of a table initialized using the VALUE clause.

#### Example 4–11 Initializing Tables with the VALUE Clause

```
01 A-TABLE VALUE IS "JANFEBMARAPRPMAYJUNJULAUAGSEPOCTNOVDEC".
03 MONTH-GROUP PIC XXX USAGE DISPLAY
   OCCURS 12 TIMES.
```

Figure 4–10 Memory Map for Example 4–11

Longword number	1			2			3				7			8			9								
Byte number	0	0	0	0	0	0	0	0	1	1	1	...	2	2	2	2	2	3	3	3	3	3	3	3	
	1	2	3	4	5	6	7	8	9	0	1	2	...	5	6	7	8	9	0	1	2	3	4	5	6
Level 01	A-TABLE																								
Level 03	M			M			M			M			...	M			M			M			M		
Byte contents	J	A	N	F	E	B	M	A	R	A	P	R	...	S	E	P	O	C	T	N	O	V	D	E	C

Legend: M = Month-Group

ZK-6047-GE

If each entry in the table has the same value, you can initialize the table as shown in Example 4–12.

#### Example 4–12 Initializing a Table with the OCCURS Clause

```
01 A-TABLE.
03 TABLE-LEG OCCURS 5 TIMES.
05 FIRST-LEG PIC X VALUE "A".
05 SECOND-LEG PIC S9(9) COMP VALUE 5.
```

In this example, there are five occurrences of each table element. Each element is initialized to the same value as follows:

- FIRST-LEG occurs five times; each occurrence is initialized to A.

## Handling Tables

### 4.2 Initializing Values of Table Elements

- SECOND-LEG occurs five times; each occurrence is initialized to 5.

Often a table is too long to initialize using a single literal, or it contains numeric, alphanumeric, COMP, COMP-1, COMP-2, or COMP SYNC items that cannot be initialized. In these situations, you can initialize individual items by redefining the group level that precedes the level containing the OCCURS clause. Consider the sample table descriptions illustrated in Example 4–13 and Example 4–14. Each fill byte between ITEM1 and ITEM2 in Example 4–13 is initialized to X. Figure 4–11 shows how this is mapped into memory.

#### Example 4–13 Initializing Mixed Usage Items

```

01 A-RECORD-ALT.
   05 FILLER PIC XX VALUE "AX".
   05 FILLER PIC S99 COMP VALUE 1.
   05 FILLER PIC XX VALUE "BX".
   05 FILLER PIC S99 COMP VALUE 2.
   .
   .
01 A-RECORD REDEFINES A-RECORD-ALT.
   03 A-GROUP OCCURS 26 TIMES.
     05 ITEM1 PIC X.
     05 ITEM2 PIC S99 COMP SYNC.

```

**Figure 4–11 Memory Map for Example 4–13**

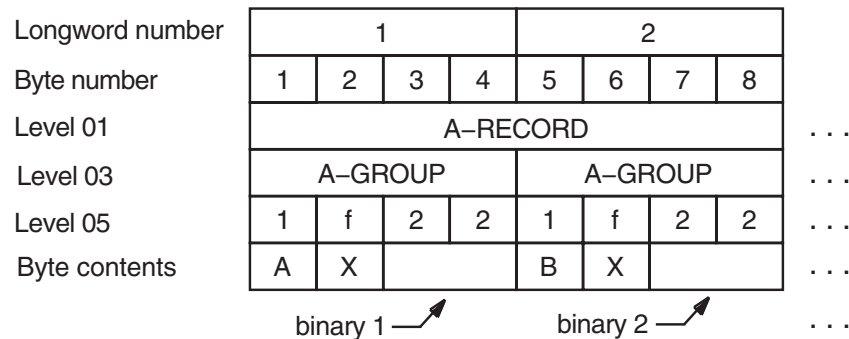

Legend: 1 = ITEM1  
 2 = ITEM2  
 f = fill byte

ZK-6048-GE

As shown in Example 4–14 and in Figure 4–12, each FILLER item initializes three 10-byte table elements.

# Handling Tables

## 4.2 Initializing Values of Table Elements

### Example 4–14 Initializing Alphanumeric Items

```

01 A-RECORD-ALT.
   03 FILLER PIC X(30) VALUE IS
      "AAAAAAAAAABBBBBBBBBBCCCCCCCCC".
   03 FILLER PIC X(30) VALUE IS
      "DDDDDDDDDEEEEEEEEEEEEEEEEEEE".
   .
   .
01 A-RECORD REDEFINES A-RECORD-ALT.
   03 ITEM1 PIC X(10) OCCURS 26 TIMES.

```

Figure 4–12 Memory Map for Example 4–14

Longword number	1		2		3		4		5		6		...														
Byte number	0	0	0	0	0	0	0	0	0	1	1	1	1	1	1	1	2	2	2	2	...						
	1	2	3	4	5	6	7	8	9	0	1	2	3	4	5	6	7	8	9	0	1	2	3	4	...		
Level 01	A-RECORD																								...		
Level 03	ITEM 1										ITEM 1										ITEM 1				...		
Byte contents at initialization time	A	A	A	A	A	A	A	A	A	A	B	B	B	B	B	B	B	B	B	B	B	B	C	C	C	C	...

ZK-6049-GE

When redefining or initializing table elements, allow space for any fill bytes that may be added due to synchronization. You do not have to initialize fill bytes, but you can do so. If you initialize fill bytes to an uncommon value, you can use them as a debugging aid in situations where a Procedure Division statement refers to the record level preceding the OCCURS clause, or to another record redefining that level.

You can also initialize tables at run time. To initialize tables at run time, use the INITIALIZE statement. This statement allows you to initialize all occurrences of a table element to the same value. For more information about the INITIALIZE statement, refer to the *HP COBOL Reference Manual*.

Sometimes the length and format of table items are such that they are best initialized using Procedure Division statements such as a MOVE statement to send a value to the table.

## 4.3 Accessing Table Elements

Once tables have been created using the OCCURS clause, the program must have a method of accessing the individual elements of those tables. Subscripting and indexing are the two methods HP COBOL provides for accessing individual table elements. To refer to a particular element within a table, follow the name of that element with a subscript or index enclosed in parentheses. The following sections describe how to identify and access table elements using subscripts and indexes.

### 4.3.1 Subscripting

A subscript can be an integer literal, an arithmetic expression, a data name, or a subscripted data name that has an integer value. The integer value represents the desired element of the table. An integer value of 3, for example, refers to the third element of a table.

### 4.3.2 Subscripting with Literals

A literal subscript is an integer value, enclosed in parentheses, that represents the desired table element. In Example 4–15, the literal subscript (2) in the MOVE instruction moves the contents of the second element of A-TABLE to I-RECORD.

#### Example 4–15 Using a Literal Subscript to Access a Table

**Table Description:**

```
01 A-TABLE.  
   03 A-GROUP PIC X(5)  
      OCCURS 10 TIMES.
```

**Instruction:**

```
MOVE A-GROUP(2) TO I-RECORD.
```

If the table is multidimensional, follow the data name of the desired data item with a list of subscripts, one for each OCCURS clause to which the item is subordinate. The first subscript in the list applies to the first OCCURS clause to which that item is subordinate. This is the most inclusive level, and is represented by A-GROUP in Example 4–16. The second subscript applies to the next most inclusive level and is represented by ITEM3 in the example. Finally, the third subscript applies to the least inclusive level, represented by ITEM5. (Note that HP COBOL can have 48 subscripts that follow the pattern in Example 4–15.)

In Example 4–16, the subscripts (2,11,3) in the MOVE statements move the third occurrence of ITEM5 in the eleventh repetition of ITEM3 in the second repetition of A-GROUP to I-FIELD5. ITEM5(1,1,1) refers to the first occurrence of ITEM5 in the table, and ITEM5(5,20,4) refers to the last occurrence of ITEM5.

#### Example 4–16 Subscripting a Multidimensional Table

**Table Description:**

```
01 A-TABLE.  
   03 A-GROUP OCCURS 5 TIMES.  
     05 ITEM1          PIC X.  
     05 ITEM2          PIC 99 COMP OCCURS 20 TIMES.  
     05 ITEM3 OCCURS 20 TIMES.  
       07 ITEM4          PIC X.  
       07 ITEM5          PIC XX OCCURS 4 TIMES.  
01 I-FIELD5          PIC XX.
```

**Procedural Instruction:**

```
MOVE ITEM5(2, 11, 3) TO I-FIELD5.
```

## Handling Tables

### 4.3 Accessing Table Elements

---

#### Note

---

Because ITEM5 is not subordinate to ITEM2, an occurrence number for ITEM2 is not permitted in the subscript list (when referencing ITEM3, ITEM4, or ITEM5). The ninth occurrence of ITEM2 in the fifth occurrence of A-GROUP will be selected by ITEM2(5,9).

---

Table 4–1 shows the subscripting rules that apply to Example 4–16.

**Table 4–1 Subscripting Rules for a Multidimensional Table**

Name of Item	Number of Subscripts Required to Refer to the Name Item	Size of Item in Bytes (Each Occurrence)
A-TABLE	NONE	1105
A-GROUP	ONE	221
ITEM1	ONE	1
ITEM2	TWO	2
ITEM3	TWO	9
ITEM4	TWO	1
ITEM5	THREE	2

#### 4.3.3 Subscripting with Data Names

You can also use data names to specify subscripts. To use a data name as a subscript, define it with COMP, COMP-1, COMP-2, COMP-3, or DISPLAY usage and with a numeric integer value. If the data name is signed, the sign must be positive at the time the data name is used as a subscript.

A data name that is a subscript can also be subscripted; for example, A(B(C)). Note that for efficiency your subscripts should be S9(5) to S9(9) COMP.

The sample subscripts and data names used in Table 4–2 refer to the table defined in Example 4–16.

**Table 4–2 Subscripting with Data Names**

Data Descriptions of Subscript Data Names	Procedural Instructions
01 SUB1 PIC 99 USAGE DISPLAY.	MOVE 2 TO SUB1.
01 SUB2 PIC S9(9) USAGE COMP.	MOVE 11 TO SUB2.
01 SUB3 PIC S99.	MOVE 3 TO SUB3.
	MOVE ITEM5(SUB1,SUB2,SUB3) TO I-FIELD5.

#### 4.3.4 Subscripting with Indexes

The same rules apply for specifying indexes as for subscripts, except that the index must be named in the INDEXED BY phrase of the OCCURS clause.



You cannot access index items as normal data items; that is, you cannot use them, redefine them, or write them to a file. However, the SET statement can change their values, and relation tests can examine their values. The index integer you specify in the SET statement must be in the range of one to the integer value in the OCCURS clause. The sample MOVE statement shown in Example 4–17 moves the contents of the third element of A-GROUP to I-FIELD.

**Example 4–17 Subscripting with Index Name Items**

**Table Description:**

```
01 A-TABLE.  
  03 A-GROUP OCCURS 5 TIMES  
    INDEXED BY IND-NAME.  
    05 ITEMC  PIC X  VALUE "C".  
    05 ITEMD  PIC X  VALUE "D".  
01 I-FIELD  PIC X(5).
```

**Procedural Instructions:**

```
SET IND-NAME TO 3.  
MOVE A-GROUP(IND-NAME) TO I-FIELD.
```

---

**Note**

---

HP COBOL initializes the value of all indexes to 1. Initializing indexes is an extension to the ANSI COBOL standard. Users who write COBOL programs that must adhere to standard COBOL should not rely on this feature.

---

### 4.3.5 Relative Indexing

To perform relative indexing when referring to a table element, you follow the index name with a plus or minus sign and an integer literal. Although it is easy to use, relative indexing generates additional overhead each time a table element is referenced in this way. The run-time overhead for relative indexing of variable-length tables is significantly greater than that required for fixed-length tables. If any of the range checks reveals an out-of-range index value, program execution terminates, and an error message is issued. You can use the -check flag (on Tru64 UNIX systems) or the /CHECK qualifier (on OpenVMS systems) to check the range when you compile the program.

On Tru64 UNIX, see Chapter 1 or the cobol man page for more information about the -check flag. ♦

On OpenVMS, invoke the online help facility for HP COBOL at the OpenVMS system prompt for more information about the /CHECK qualifier. ♦

The following sample MOVE statement moves the fourth repetition of A-GROUP to I-FIELD:

```
SET IND-NAME TO 1.  
MOVE A-GROUP(IND-NAME + 3) TO I-FIELD.
```

## Handling Tables

### 4.3 Accessing Table Elements

#### 4.3.6 Index Data Items

Often a program requires that the value of an index be stored outside of that item. HP COBOL provides the index data item to fulfill this requirement.

Index data items are stored as longword COMP items and must be declared with a USAGE IS INDEX phrase in the item description. Index data items can be explicitly modified only with the SET statement.

#### 4.3.7 Assigning Index Values Using the SET Statement

You can use the SET statement to assign values to indexes associated with tables to reference particular table elements. The following sections discuss the two relevant SET statement formats. (All six SET statement formats are shown in the *HP COBOL Reference Manual*.)

##### 4.3.7.1 Assigning an Integer Index Value with a SET Statement

When you use the SET statement, the index is set to the value you specify. The most straightforward use of the SET statement is to set an index name to an integer literal value. This example assigns a value of 5 to IND-5:

```
SET IND-5 TO 5.
```

You can also set an index name to an integer data item. For example:

```
SET INDEX-A TO COUNT-1.
```

More than one index can be set with a single SET statement. For example:

```
SET TAB1-IND TAB2-IND TO 15.
```

Table indexes specified in INDEXED BY phrases can be displayed by using the WITH CONVERSION option with the DISPLAY statement. Also, you can display, move, and manipulate the value of the table index with an index data item. You do this by setting an index data item to the present value of an index. You can, for example, set an index data item and then display its value as shown in the following example:

```
SET INDEX-ITEM TO TAB-IND.  
:  
:  
:  
DISPLAY INDEX-ITEM WITH CONVERSION.
```

##### 4.3.7.2 Incrementing an Index Value with the SET Statement

You can use the SET statement with the UP BY/DOWN BY clause to arithmetically alter the value of a index. A numeric literal is added to (UP BY) or subtracted from (DOWN BY) a table index. For example:

```
SET TABLE-INDEX UP BY 12.
```

```
SET TABLE-INDEX DOWN BY 5.
```

#### 4.3.8 Identifying Table Elements Using the SEARCH Statement

The SEARCH statement is used to search a table for an element that satisfies a known condition. The statement provides for sequential and binary searches, which are described in the following sections.

#### 4.3.8.1 Implementing a Sequential Search

The SEARCH statement allows you to perform a sequential search of a table. The OCCURS clause of the table description entry must contain the INDEXED BY phrase. If more than one index is specified in the INDEXED BY phrase, the first index is the controlling index for the table search unless you specify otherwise in the SEARCH statement.

The search begins at the current index setting and progresses through the table, checking each element against the conditional expression. The index is incremented by 1 as each element is checked. If the conditional expression is true, the associated imperative statement executes; otherwise, program control passes to the next procedural sentence. This terminates the search, and the index points to the current table element that satisfied the conditional expression.

If no table element is found that satisfies the conditional expression, program control passes to the AT END exit path; otherwise, program control passes to the next procedural sentence.

You can use the optional VARYING phrase of the SEARCH statement by specifying any of the following:

- VARYING index name associated with table search
- VARYING index data item or integer data item
- VARYING index name not associated with table search

Regardless of which method you use, the index specified in the INDEXED BY phrase of the table being searched is incremented. This controlling index, when compared against the allowable number of occurrences in the table, dictates the permissible search range. When the search terminates, either successfully or unsuccessfully, the index remains at its current setting. At this point, you can reference the data in the table element pointed to by the index, unless the AT END condition is true. If the AT END condition is true, and if the -check flag (on Tru64 UNIX systems) or the /CHECK qualifier (on OpenVMS systems) has been specified, the compiler issues a run-time error message indicating that the subscript is out of range.

When you vary an index associated with the table being searched, the index name can be any index you specify in the INDEXED BY phrase. It becomes the controlling index for the search and is the only index incremented. Example 4-18 and Example 4-20 show how to vary an index other than the first index.

When you vary an index data item or an integer data item, either the index data item or the integer data item is incremented. The first index name you specify in the INDEXED BY phrase of the table being searched becomes the controlling index and is also incremented. The index data item or the integer data item you vary does not function as an index; it merely allows you to maintain an additional pointer to elements within a table. Example 4-18 and Example 4-21 show how to vary an index data item or an integer data item.

When you vary an index associated with a table other than the one you are searching, the controlling index is the first index you specify in the INDEXED BY phrase of the table you are searching. Each time the controlling index is incremented, the index you specify in the VARYING phrase is incremented. In this manner, you can search two tables in synchronization. Example 4-18 and Example 4-22 show how to vary an index associated with a table other than the one you are searching.

## Handling Tables

### 4.3 Accessing Table Elements

When you omit the VARYING phrase, the first index you specify in the INDEXED BY phrase becomes the controlling index. Only this index is incremented during a serial search. Example 4–18 and Example 4–23 show how to perform a serial search without using the VARYING phrase.

#### 4.3.8.2 Implementing a Binary Search

You can use the SEARCH statement to perform a nonsequential (binary) table search.

To perform a binary search, you must specify an index name in the INDEXED BY phrase and a search key in the KEY IS phrase of the OCCURS clause of the table being searched.

A binary search depends on the ASCENDING/DESCENDING KEY attributes. If you specify an ASCENDING KEY, the data in the table must either be stored in ascending order or sorted in ascending order prior to the search. For a DESCENDING KEY, data must be stored or sorted in descending order prior to the search.

On Alpha and I64 systems, you can sort an entire table in preparation for a binary search. Use the SORT statement (Format 2, an HP extension), described in the *HP COBOL Reference Manual*. ♦

During a binary search, the first (or only) index you specify in the INDEXED BY phrase of the OCCURS clause of the table being searched is the controlling index. You do not have to initialize an index in a binary search because index manipulation is automatic.

In addition to being generally faster than a sequential search, a binary search allows multiple equality checks.

The following search sequence lists the capabilities of a binary search. At program execution time, the system:

1. Examines the range of permissible index values, selects the median value, and assigns this value to the index.
2. Checks for equality in WHEN and AND clauses.
3. Terminates the search if all equality statements are true. If you use the imperative statement after the final equality clause, that statement executes; otherwise, program control passes to the next procedural sentence, the search exits, and the index retains its current value.
4. Takes the following actions if the equality test of a table element is false:
  - a. Executes the imperative statement associated with the AT END statement (if present) when all table elements have been tested. If there is no AT END statement, program control passes to the next procedural statement.
  - b. Determines which half of the table is to be eliminated from further consideration. This is based on whether the key being tested was specified as ASCENDING or DESCENDING and whether the test failed because of a greater-than or less-than comparison. For example, if the key values are stored in ascending order, and the median table element being tested is greater than the value of the argument, then all key elements following the one being tested must also be greater. Therefore, the upper half of the table is removed from further consideration and the search continues at the median point of the lower half.
  - c. Begins processing all over again at Step 1.

## Handling Tables

### 4.3 Accessing Table Elements

A useful variation of the binary search is that of specifying multiple search keys. Multiple search keys allow you to select a specified table element from among several elements that have duplicate low-order keys. An example is a telephone listing where several people have the same last and first names, but different middle initials. All specified keys must be either ascending or descending. Example 4–24 shows how to use multiple search keys.

The table in Example 4–18 is followed by several examples (Examples 4–19, 4–20, 4–21, 4–22, and 4–23) of how to search it.

#### Example 4–18 Sample Table

```
DATA DIVISION.
WORKING-STORAGE SECTION.
01 TEMP-IND                                     USAGE IS INDEX.
01 FED-TAX-TABLES.
    02 ALLOWANCE-DATA.
        03 FILLER                               PIC X(70) VALUE
            "0101440
-           "0202880
-           "0304320
-           "0405760
-           "0507200
-           "0608640
-           "0710080
-           "0811520
-           "0912960
-           "1014400".
    02 ALLOWANCE-TABLE REDEFINES ALLOWANCE-DATA.
        03 FED-ALLOWANCES OCCURS 10 TIMES
            ASCENDING KEY IS ALLOWANCE-NUMBER
            INDEXED BY IND-1.
            04 ALLOWANCE-NUMBER                 PIC XX.
            04 ALLOWANCE                         PIC 99999.

    02 SINGLES-DEDUCTION-DATA.
        03 FILLER                               PIC X(112) VALUE
            "0250006700000016
-           "0670011500067220
-           "1150018300163223
-           "1830024000319621
-           "2400027900439326
-           "2790034600540730
-           "3460099999741736".
    02 SINGLE-DEDUCTION-TABLE REDEFINES SINGLES-DEDUCTION-DATA.
        03 SINGLES-TABLE OCCURS 7 TIMES
            ASCENDING KEY IS S-MIN-RANGE S-MAX-RANGE
            INDEXED BY IND-2, TEMP-INDEX.
            04 S-MIN-RANGE                       PIC 99999.
            04 S-MAX-RANGE                       PIC 99999.
            04 S-TAX                             PIC 9999.
            04 S-PERCENT                         PIC V99.
```

(continued on next page)

## Handling Tables

### 4.3 Accessing Table Elements

#### Example 4–18 (Cont.) Sample Table

```
02 MARRIED-DEDUCTION-DATA.
03 FILLER                                PIC X(119) VALUE
   "04800096000000017
-   "09600173000081620
-   "17300264000235617
-   "26400346000390325
-   "34600433000595328
-   "43300500000838932
-   "50000999991053336".
02 MARRIED-DEDUCTION-TABLE REDEFINES MARRIED-DEDUCTION-DATA.
03 MARRIED-TABLE OCCURS 7 TIMES
   ASCENDING KEY IS M-MIN-RANGE M-MAX-RANGE
   INDEXED BY IND-0, IND-3.
04 M-MIN-RANGE                            PIC 99999.
04 M-MAX-RANGE                            PIC 99999.
04 M-TAX                                  PIC 99999.
04 M-PERCENT                              PIC V99.
```

Example 4–19 shows how to perform a serial search.

#### Example 4–19 A Serial Search

```
01 TAXABLE-INCOME PIC 9(6) VALUE 50000.
01 FED-TAX-DEDUCTION PIC 9(6).
PROCEDURE DIVISION.
BEGIN.
   PERFORM SINGLE.
   DISPLAY FED-TAX-DEDUCTION.
   STOP RUN.
SINGLE.
   IF TAXABLE-INCOME < 02500
      GO TO END-FED-COMP.
   SET IND-2 TO 1.
   SEARCH SINGLES-TABLE AT END
      GO TO TABLE-2-ERROR
      WHEN TAXABLE-INCOME = S-MIN-RANGE(IND-2)
         MOVE S-TAX(IND-2) TO FED-TAX-DEDUCTION
      WHEN TAXABLE-INCOME < S-MAX-RANGE(IND-2)
         COMPUTE FED-TAX-DEDUCTION =
            S-TAX(IND-2) + (TAXABLE-INCOME - S-TAX(IND-2)) *
            S-PERCENT(IND-2).
   .
   .
   .
```

Example 4–20 shows how to use SEARCH while varying an index other than the first index.

Example 4–21 shows how to use SEARCH while varying an index data item.

## Handling Tables

### 4.3 Accessing Table Elements

#### Example 4–20 Using SEARCH and Varying an Index Other than the First Index

```
01 TAXABLE-INCOME PIC 9(6) VALUE 50000.
01 FED-TAX-DEDUCTION PIC 9(6).
PROCEDURE DIVISION.
BEGIN.
    PERFORM MARRIED.
    DISPLAY FED-TAX-DEDUCTION.
    STOP RUN.
MARRIED.
    IF TAXABLE-INCOME < 04800
        MOVE ZEROS TO FED-TAX-DEDUCTION
        GO TO END-FED-COMP.
    SET IND-3 TO 1.
    SEARCH MARRIED-TABLE VARYING IND-3 AT END
        GO TO TABLE-3-ERROR
    WHEN TAXABLE-INCOME = M-MIN-RANGE(IND-3)
        MOVE M-TAX(IND-3) TO FED-TAX-DEDUCTION
    WHEN TAXABLE-INCOME < M-MAX-RANGE(IND-3)
        COMPUTE FED-TAX-DEDUCTION =
            M-TAX(IND-3) + (TAXABLE-INCOME - M-TAX(IND-3)) *
            M-PERCENT(IND-3).
    .
    .
    .
```

#### Example 4–21 Using SEARCH and Varying an Index Data Item

```
01 TAXABLE-INCOME PIC 9(6) VALUE 50000.
01 FED-TAX-DEDUCTION PIC 9(6).
PROCEDURE DIVISION.
BEGIN.
    PERFORM SINGLE.
    DISPLAY FED-TAX-DEDUCTION.
    STOP RUN.
SINGLE.
    IF TAXABLE-INCOME < 02500
        GO TO END-FED-COMP.
    SET IND-2 TO 1.
    SEARCH SINGLES-TABLE VARYING TEMP-IND AT END
        GO TO TABLE-2-ERROR
    WHEN TAXABLE-INCOME = S-MIN-RANGE(IND-2)
        MOVE S-TAX(IND-2) TO FED-TAX-DEDUCTION
    WHEN TAXABLE-INCOME < S-MAX-RANGE(IND-2)
        MOVE S-TAX(IND-2) TO FED-TAX-DEDUCTION
        SUBTRACT S-MIN-RANGE(IND-2) FROM TAXABLE-INCOME
        MULTIPLY TAXABLE-INCOME BY S-PERCENT(IND-2) ROUNDED
        ADD TAXABLE-INCOME TO FED-TAX-DEDUCTION.
    .
    .
    .
```

Example 4–22 shows how to use SEARCH while varying an index not associated with the target table.

## Handling Tables

### 4.3 Accessing Table Elements

#### Example 4–22 Using SEARCH and Varying an Index not Associated with the Target Table

```
01 TAXABLE-INCOME PIC 9(6) VALUE 50000.
01 FED-TAX-DEDUCTION PIC 9(6).
PROCEDURE DIVISION.
BEGIN.
    PERFORM SINGLE.
    DISPLAY FED-TAX-DEDUCTION.
    STOP RUN.
SINGLE.
    IF TAXABLE-INCOME < 02500
        GO TO END-FED-COMP.
    SET IND-2 TO 1.
    SEARCH SINGLES-TABLE VARYING IND-0 AT END
        GO TO TABLE-2-ERROR
        WHEN TAXABLE-INCOME = S-MIN-RANGE(IND-2)
            MOVE S-TAX(IND-2) TO FED-TAX-DEDUCTION
        WHEN TAXABLE-INCOME < S-MAX-RANGE(IND-2)
            MOVE S-TAX(IND-2) TO FED-TAX-DEDUCTION
            SUBTRACT S-MIN-RANGE(IND-2) FROM TAXABLE-INCOME
            MULTIPLY TAXABLE-INCOME BY S-PERCENT(IND-2) ROUNDED
            ADD TAXABLE-INCOME TO FED-TAX-DEDUCTION.
    .
    .
    .
```

Example 4–23 shows how to perform a serial search without using the VARYING phrase.

#### Example 4–23 Doing a Serial Search Without Using the VARYING Phrase

```
01 NR-DEPENDENTS PIC 9(2) VALUE 3.
01 GROSS-WAGE PIC 9(6) VALUE 50000.
01 TAXABLE-INCOME PIC 9(6) VALUE 50000.
01 FED-TAX-DEDUCTION PIC9(6).
01 MARITAL-STATUS PIC X VALUE "M".
PROCEDURE DIVISION.
BEGIN.
    PERFORM FED-DEDUCT-COMPUTATION.
    DISPLAY TAXABLE-INCOME.
    STOP RUN.
FED-DEDUCT-COMPUTATION.
    SET IND-1 TO 1.
    SEARCH FED-ALLOWANCES AT END
        GO TO TABLE-1-ERROR
        WHEN ALLOWANCE-NUMBER(IND-1) = NR-DEPENDENTS
            SUBTRACT ALLOWANCE(IND-1) FROM GROSS-WAGE
            GIVING TAXABLE-INCOME ROUNDED.
    IF MARITAL-STATUS = "M"
        GO TO MARRIED.
MARRIED.
    .
    .
    .
```



## Handling Tables

### 4.3 Accessing Table Elements

Example 4–24 shows how to perform a multiple-key, binary search.

#### Example 4–24 A Multiple-Key, Binary Search

```
IDENTIFICATION DIVISION.
PROGRAM-ID. MULTI-KEY-SEARCH.
DATA DIVISION.
WORKING-STORAGE SECTION.
01 DIRECTORY-TABLE.
   05 NAMES-NUMBERS.
      10 FILLER                                PIC X(30)
         VALUE "SMILEY    HAPPY    T.213-4332".
      10 FILLER                                PIC X(30)
         VALUE "SMITH     ALAN     C.881-4987".
      10 FILLER                                PIC X(30)
         VALUE "SMITH     CHARLES  J.345-2398".
      10 FILLER                                PIC X(30)
         VALUE "SMITH     FREDERICK 745-0223".
      10 FILLER                                PIC X(30)
         VALUE "SMITH     HARRY     C.573-3306".
      10 FILLER                                PIC X(30)
         VALUE "SMITH     HARRY     J.295-3485".
      10 FILLER                                PIC X(30)
         VALUE "SMITH     LARRY     X.976-5504".
      10 FILLER                                PIC X(30)
         VALUE "SMITHWOOD ALBERT    J.349-9927".
   05 PHONE-DIRECTORY-TABLE REDEFINES NAMES-NUMBERS OCCURS 8 TIMES
      ASCENDING KEY IS LAST-NAME
                      FIRST-NAME
                      MID-INIT
                      INDEXED BY DIR-INDX.
      15 LAST-NAME    PIC X(10).
      15 FIRST-NAME   PIC X(10).
      15 MID-INIT     PIC XX.
      15 PHONE-NUM    PIC X(8).
PROCEDURE DIVISION.
MULTI-KEY-BINARY-SEARCH.
   SEARCH ALL PHONE-DIRECTORY-TABLE
      WHEN LAST-NAME(DIR-INDX) = "SMITH"
      AND FIRST-NAME(DIR-INDX) = "HARRY"
      AND MID-INIT(DIR-INDX) = "J."
      NEXT SENTENCE.
DISPLAY-RESULTS.
   DISPLAY LAST-NAME(DIR-INDX) ", "
          FIRST-NAME(DIR-INDX)
          MID-INIT(DIR-INDX) " "
          PHONE-NUM(DIR-INDX).
```



---

## Using the **STRING**, **UNSTRING**, and **INSPECT** Statements

The **STRING**, **UNSTRING**, and **INSPECT** statements give your HP COBOL programs the following capabilities:

- Concatenating data using the **STRING** statement (Section 5.1)
- Separating data using the **UNSTRING** statement (Section 5.2)
- Examining and replacing characters using the **INSPECT** statement (Section 5.3)

### 5.1 Concatenating Data Using the **STRING** Statement

The **STRING** statement concatenates the contents of one or more sending items into a single receiving item.

The statement has many forms; the simplest is equivalent in function to a nonnumeric **MOVE** statement. Consider the following example:

```
STRING FIELD1 DELIMITED BY SIZE INTO FIELD2.
```

If the two items are the same size, or if the sending item (**FIELD1**) is larger, the statement is equivalent to the following statement:

```
MOVE FIELD1 TO FIELD2.
```

If the sending item of the string is shorter than the receiving item, the compiler does not replace unused positions in the receiving item with spaces. Thus, the **STRING** statement can leave some portion of the receiving item unchanged.

The receiving item of the string must be an elementary alphanumeric item with no **JUSTIFIED** clause or editing characters in its description. Thus, the data movement of the **STRING** statement always fills the receiving item with the sending item from left to right and with no editing insertions.

#### 5.1.1 Multiple Sending Items

The **STRING** statement can concatenate a series of sending items into one receiving item. Consider the following example:

```
STRING FIELD1A FIELD1B FIELD1C DELIMITED BY SIZE  
      INTO FIELD2.
```

In this sample **STRING** statement, **FIELD1A**, **FIELD1B**, and **FIELD1C** are all sending items. The compiler moves them to the receiving item (**FIELD2**) in the order in which they appear in the statement, from left to right, resulting in the concatenation of their values.

## Using the STRING, UNSTRING, and INSPECT Statements

### 5.1 Concatenating Data Using the STRING Statement

If FIELD2 is not large enough to hold all three items, the operation stops when it is full. If the operation stops while moving one of the sending items, the compiler ignores the remaining characters of that item and any other sending items not yet processed. For example, if FIELD2 is filled while it is receiving FIELD1B, the compiler ignores the rest of FIELD1B and all of FIELD1C.

If the sending items do not fill the receiving item, the operation stops when the last character of the last sending item (FIELD1C) is moved. It does not alter the contents nor space-fill the remaining character positions of the receiving item.

The sending items can be nonnumeric literals and figurative constants (except for ALL literal). Example 5–1 sets up an address label by stringing the data items CITY, STATE, and ZIP into ADDRESS-LINE. The figurative constant SPACE and the literal period (.) are used to separate the information.

#### Example 5–1 Using the STRING Statement and Literals

```
01 ADDRESS-GROUP.  
   03 CITY          PIC X(20).  
   03 STATE         PIC XX.  
   03 ZIP           PIC X(5).  
01 ADDRESS-LINE    PIC X(31).  
.  
.  
.  
PROCEDURE DIVISION.  
BEGIN.  
   STRING CITY SPACE STATE "." SPACE ZIP  
       DELIMITED BY SIZE INTO ADDRESS-LINE.  
.  
.  
.
```

#### 5.1.2 Using the DELIMITED BY Phrase

Although the sending items of the STRING statement are fixed in size at compile time, they are frequently filled with spaces. For example, if a 20-character city item contains the text MAYNARD followed by 13 spaces, the STRING statement using the DELIMITED BY SIZE phrase would move the text (MAYNARD) and the unwanted 13 spaces (assuming the receiving item is at least 20 characters long). The DELIMITED BY phrase, written with a data name or literal, eliminates this problem.

The delimiter can be a literal, a data item, a figurative constant, or the word SIZE. It cannot, however, be ALL literal, because ALL literal has an indefinite length. When the phrase contains the word SIZE, the compiler moves each sending item in total, until it either exhausts the characters in the sending item or fills the receiving item.

If you use the code in Example 5–1, and CITY is a 20-character item, the result of the STRING operation might look like Figure 5–1.

## Using the STRING, UNSTRING, and INSPECT Statements

### 5.1 Concatenating Data Using the STRING Statement

Figure 5–1 Results of the STRING Operation

```
AYER          MA. 01432
└──────────┬──┘
            |
            v
          16 spaces
                ZK-6051-GE
```

A more attractive and readable report can be produced by having the STRING operation produce this line:

```
AYER, MA. 01432
```

To accomplish this, use the figurative constant SPACE as a delimiter on the sending item:

```
MOVE 1 TO P.
STRING CITY DELIMITED BY SPACE
        INTO ADDRESS-LINE WITH POINTER P.
STRING ", " STATE ". " ZIP
        DELIMITED BY SIZE
        INTO ADDRESS-LINE WITH POINTER P.
```

This example makes use of the POINTER phrase (see Section 5.1.3). The first STRING statement moves data characters until it encounters a space character—a match of the delimiter SPACE. The second STRING statement supplies the literal, the 2-character STATE item, another literal, and the 5-character ZIP item.

The delimiter can be varied for each item within a single STRING statement by repeating the DELIMITED BY phrase after each of the sending item names to which it applies. Thus, the shorter STRING statement in the following example has the same effect as the two STRING statements in the preceding example. (Placing the operands on separate source lines has no effect on the operation of the statement, but it improves program readability and simplifies debugging.)

```
STRING CITY DELIMITED BY SPACE
        ", " STATE ". "
        ZIP DELIMITED BY SIZE
        INTO ADDRESS-LINE.
```

The sample STRING statement cannot handle 2-word city names, such as San Francisco, because the compiler considers the space between the two words as a match for the delimiter SPACE. A longer delimiter, such as two or three spaces (nonnumeric literal), can solve this problem. Only when a sequence of characters matches the delimiter does the movement stop for that data item. With a 2-character delimiter, the same statement can be rewritten in a simpler form:

```
STRING CITY " , " STATE ". " ZIP
        DELIMITED BY "  " INTO ADDRESS-LINE.
```

Because only the CITY item contains two consecutive spaces, the delimiter's search of the other items will always be unsuccessful, and the effect is the same as moving the full item (delimiting by SIZE).

Data movement under control of a data name or literal generally executes more slowly than data movement delimited by SIZE.

## Using the STRING, UNSTRING, and INSPECT Statements

### 5.1 Concatenating Data Using the STRING Statement

Remember, the remainder of the receiving item is not space-filled, as with a MOVE statement. If ADDRESS-LINE is to be printed on a mailing label, for example, the STRING statement should be preceded by the statement:

```
MOVE SPACES TO ADDRESS-LINE.
```

This statement guarantees a space-fill to the right of the concatenated result. Alternatively, the last item concatenated by the STRING statement can be an item previously set to SPACES. This sending item must either be moved under control of a delimiter other than SPACE or use the value of POINTER and reference modification.

#### 5.1.3 Using the POINTER Phrase

Although the STRING statement normally starts scanning at the leftmost position of the receiving item, the POINTER phrase makes it possible to start scanning at another point within the item. The scanning, however, continues left to right. Consider the following example:

```
MOVE 5 TO P.  
STRING FIELD1A FIELD1B DELIMITED BY SIZE  
      INTO FIELD2 WITH POINTER P.
```

The value of P determines the starting character position in the receiving item. In this example, the 5 in P causes the program to move the first character of FIELD1A into character position 5 of FIELD2 (the leftmost character position of the receiving item is character position 1), and leave positions 1 to 4 unchanged.

When the STRING operation is complete, P points to one character position beyond the last character replaced in the receiving item. If FIELD1A and FIELD1B are both four characters long, P contains a value of 13 (5+4+4) when the operation is complete (assuming that FIELD2 is at least 13 characters long).

#### 5.1.4 Using the OVERFLOW Phrase

When the SIZE option of the DELIMITED BY phrase controls the STRING operation, and the pointer value is either known or the POINTER phrase is not used, you can add the PICTURE sizes of sending items together at program development time to see if the receiving item is large enough to hold the sending items. However, if the DELIMITED BY phrase contains a literal or an identifier, or if the pointer value is not predictable, it can be difficult to tell whether or not the size of the receiving item will be large enough at run time. If the size of the receiving item is not large enough, an overflow can occur.

An overflow occurs when the receiving item is full and the program is either about to move a character from a sending item or is considering a new sending item. Overflow can also occur if, during the initialization of the statement, the pointer contains a value that is either less than 1 or greater than the length of the receiving item. In this case, the program moves no data to the receiving item and terminates the operation immediately.

The ON OVERFLOW phrase at the end of the STRING statement tests for an overflow condition:

```
STRING FIELD1A FIELD1B DELIMITED BY "C"  
      INTO FIELD2 WITH POINTER PNTR  
      ON OVERFLOW GO TO 200-STRING-OVERFLOW.
```

## Using the STRING, UNSTRING, and INSPECT Statements

### 5.1 Concatenating Data Using the STRING Statement

The ON OVERFLOW phrase cannot distinguish the overflow caused by a bad initial value in the pointer from the overflow caused by a receiving item that is too short. Only a separate test preceding the STRING statement can distinguish between the two.

Additionally, even if an overflow condition does not exist, you can use the NOT ON OVERFLOW phrase to branch to or execute other sections of code.

Example 5–2 illustrates the overflow condition.

#### Example 5–2 Sample Overflow Condition

```
DATA DIVISION.  
    .  
    .  
    .  
01 FIELD1 PIC XXX VALUE "ABC".  
01 FIELD2 PIC XXXX.  
PROCEDURE DIVISION.  
    .  
    .  
1.  STRING FIELD1 QUOTE DELIMITED BY SIZE INTO FIELD2  
    ON OVERFLOW DISPLAY "overflow at 1".  
2.  STRING FIELD1 FIELD1 DELIMITED BY SIZE INTO FIELD2  
    ON OVERFLOW DISPLAY "overflow at 2".  
3.  STRING FIELD1 FIELD1 DELIMITED BY "C" INTO FIELD2  
    ON OVERFLOW DISPLAY "overflow at 3".  
4.  STRING FIELD1 FIELD1 FIELD1 FIELD1  
    DELIMITED BY "B" INTO FIELD2 ON OVERFLOW DISPLAY "overflow at 4".  
5.  STRING FIELD1 FIELD1 "D" DELIMITED BY "C"  
    INTO FIELD2 ON OVERFLOW DISPLAY "overflow at 5".  
6.  MOVE 2 TO P.  
  
    MOVE ALL QUOTES TO FIELD2.  
  
    STRING FIELD1 "AC" DELIMITED BY "C"  
    INTO FIELD2 WITH POINTER P ON OVERFLOW DISPLAY "overflow at 6".
```

The STRING statement numbers in Example 5–2 point to the line number results shown in Table 5–1.

**Table 5–1 Results of Sample Overflow Statements**

Value of FIELD2 After the STRING Operation	Overflow?
1. ABC"	No
2. ABCA	Yes
3. ABAB	No
4. AAAA	No
5. ABAB	Yes
6. "ABA	No

## Using the **STRING**, **UNSTRING**, and **INSPECT** Statements

### 5.1 Concatenating Data Using the **STRING** Statement

#### 5.1.5 Common **STRING** Statement Errors

The following are common errors made when writing **STRING** statements:

- Using the word **TO** instead of **INTO**
- Failing to include the **DELIMITED BY SIZE** phrase
- Failing to initialize the pointer
- Initializing the pointer to 0 instead of 1
- Permitting the pointer to get out of range (negative or larger than the size of the receiving field)
- Failing to provide for space-filling of the receiving item when it is desirable
- Using the pointer as a subscript without fully understanding subscript evaluation

### 5.2 Separating Data Using the **UNSTRING** Statement

The **UNSTRING** statement disperses the contents of a single sending item into one or more receiving items.

The statement has many forms; the simplest is equivalent in function to a nonnumeric **MOVE** statement. Consider the following example:

```
UNSTRING FIELD1 INTO FIELD2.
```

Regardless of the relative sizes of the two items, the sample statement is equivalent to the following **MOVE** statement:

```
MOVE FIELD1 TO FIELD2.
```

The sending item (**FIELD1**) can be either (1) a group item, or (2) an alphanumeric or alphanumeric edited elementary item. The receiving item (**FIELD2**) can be alphabetic, alphanumeric, or numeric, but it cannot specify any type of editing.

If the receiving item is numeric, it must be **DISPLAY** usage. The **PICTURE** character-string of a numeric receiving item can contain any of the legal numeric description characters except **P** and the editing characters. The **UNSTRING** statement moves the sending item to the numeric receiving item as if the sending item had been described as an unsigned integer. It automatically truncates or zero-fills as required.

If the receiving item is not numeric, the statement follows the rules for elementary nonnumeric **MOVE** statements. It left-justifies the data in the receiving item, truncating or space-filling as required. If the data description of the receiving item contains a **JUSTIFIED** clause, the compiler right-justifies the data, truncating or space-filling to the left as required.

#### 5.2.1 Multiple Receiving Items

The **UNSTRING** statement can disperse one sending item into several receiving items. Consider the following example of the **UNSTRING** statement written with multiple receiving items:

```
UNSTRING FIELD1 INTO FIELD2A FIELD2B FIELD2C.
```



## Using the STRING, UNSTRING, and INSPECT Statements

### 5.2 Separating Data Using the UNSTRING Statement

The compiler-generated code performs the UNSTRING operation by scanning across FIELD1, the sending item, from left to right. When the number of characters scanned equals the number of characters in the receiving item, the scanned characters are moved into that item and the next group of characters is scanned for the next receiving item.

If each of the receiving items in the preceding example (FIELD2A, FIELD2B, and FIELD2C) is 5 characters long, and FIELD1 is 15 characters long, FIELD1 is scanned until the number of characters scanned equals the size of FIELD2A (5). Those first five characters are moved to FIELD2A, and scanning is resumed at the sixth character position in FIELD1. Next, FIELD1 is scanned from character position 6, until the number of scanned characters equals the size of FIELD2B (five). The sixth through the tenth characters are then moved to FIELD2B, and the scanner is set to the next (eleventh) character position in FIELD1. For the last move in this example, characters 11 to 15 of FIELD1 are moved into FIELD2C.

Each data movement acts as an individual MOVE statement, the sending item of which is an alphanumeric item equal in size to the receiving item. If the receiving item is numeric, the move operation converts the data to numeric form. For example, consider what would happen if the items under discussion had the data descriptions and were manipulating the values shown in Table 5–2.

**Table 5–2 Values Moved into the Receiving Items Based on the Sending Item Value**

FIELD1 PIC X(15) VALUE IS:	FIELD2A PIC X(5)	FIELD2B PIC S9(5) LEADING SEPARATE	FIELD2C PIC S999V99
ABCDE1234512345	ABCDE	+12345	3450{
XXXXX0000100123	XXXXX	+00001	1230{

FIELD2A is an alphanumeric item. Therefore, the statement simply conducts an elementary nonnumeric move with the first five characters.

FIELD2B, however, has a leading separate sign that is not included in its size. Thus, the compiler moves only five numeric characters and generates a positive sign (+) in the separate sign position.

FIELD2C has an implied decimal point with two character positions to the right of it, plus an overpunched sign on the low-order digit. The sending item should supply five numeric digits. However, because the sending item is alphanumeric, the compiler treats it as an unsigned integer; it truncates the two high-order digits and supplies two zero digits for the decimal positions. Furthermore, it supplies a positive overpunch sign, making the low-order digit a +0 (ASCII { ). There is no way to have the UNSTRING statement recognize a sign character or a decimal point in the sending item in a single statement.

If the sending item is shorter than the sum of the sizes of the receiving items, the compiler ignores the remaining receiving items. If the compiler reaches the end of the sending item before it reaches the end of one of the receiving items, it moves the scanned characters into that receiving item. It either left-justifies and fills the remaining character positions with spaces for alphanumeric data, or else it decimal point-aligns and zero-fills the remaining character positions for numeric data.

## Using the STRING, UNSTRING, and INSPECT Statements

### 5.2 Separating Data Using the UNSTRING Statement

Consider the following statement with reference to the corresponding PICTURE character-strings and values in Table 5–3:

```
UNSTRING FIELD1 INTO FIELD2A FIELD2B.
```

FIELD2A is a 3-character alphanumeric item. It receives the first three characters of FIELD1 (ABC) in every operation. FIELD2B, however, runs out of characters every time before filling, as Table 5–3 illustrates.

**Table 5–3 Handling a Short Sending Item**

FIELD1 PIC X(6) VALUE IS:	FIELD2B PICTURE IS:	FIELD2B Value After UNSTRING Operation
ABCDEF	XXXXX	DEF
	S99999	0024F
ABC246	S9V999	600{
	S9999 LEADING SEPARATE	+0246

#### 5.2.2 Controlling Moved Data Using the DELIMITED BY Phrase

The size of the data to be moved can be controlled by a delimiter, rather than by the size of the receiving item. The DELIMITED BY phrase supplies the delimiter characters.

UNSTRING delimiters can be literals, figurative constants (including ALL literal), or identifiers (identifiers can even be subscripted data names). This section describes the use of these three types of delimiters. Subsequent sections cover multiple delimiters, the COUNT phrase, and the DELIMITER phrase.

Consider the following sample UNSTRING statement with the figurative constant SPACE as a delimiter:

```
UNSTRING FIELD1 DELIMITED BY SPACE
      INTO FIELD2.
```

In this example, the compiler scans the sending item (FIELD1), searching for a space character. If it encounters a space, it moves all of the scanned (non-space) characters that precede that space to the receiving item (FIELD2). If it finds no space character, it moves the entire sending item. When the compiler has determined the size of the sending item, it moves the contents of that item following the rules for the MOVE statement, truncating or zero-filling as required.

Table 5–4 shows the results of the following UNSTRING operation that uses a literal asterisk delimiter:

```
UNSTRING FIELD1 DELIMITED BY "*"
      INTO FIELD2.
```

## Using the STRING, UNSTRING, and INSPECT Statements

### 5.2 Separating Data Using the UNSTRING Statement

**Table 5–4 Results of Delimiting with an Asterisk**

FIELD1 PIC X(6) VALUE IS:	FIELD2 PICTURE IS:	FIELD2 Value After UNSTRING
	XXX	ABC
ABCDEF	X(7)	ABCDEF
	XXX JUSTIFIED	DEF
*****	XXX	###
*ABCDE	XXX	###
A*****	XXX JUSTIFIED	##A
246***	S9999	024F
12345*	S9999 TRAILING SEPARATE	2345+
2468**	S999V9 LEADING SEPARATE	+4680
*246**	9999	0000

Legend: # = space

If the delimiter matches the first character in the sending item, the compiler considers the size of the sending item to be zero. The operation still takes place, however, and fills the receiving item with spaces (if it is nonnumeric) or zeros (if it is numeric).

A delimiter can also be applied to an UNSTRING statement that has multiple receiving items:

```
UNSTRING FIELD1 DELIMITED BY SPACE
      INTO FIELD2A FIELD2B.
```

The compiler generates code that scans FIELD1 searching for a character that matches the delimiter. If it finds a match, it moves the scanned characters to FIELD2A and sets the scanner to the next character position to the right of the character that matched. The compiler then resumes scanning FIELD1 for a character that matches the delimiter. If it finds a match, it moves all of the characters between the character that first matched the delimiter and the character that matched on the second scan, and sets the scanner to the next character position to the right of the character that matched.

The DELIMITED BY phrase handles additional items in the same manner as it handled FIELD2B.

Table 5–5 illustrates the results of the following delimited UNSTRING operation into multiple receiving items:

```
UNSTRING FIELD1 DELIMITED BY "*"
      INTO FIELD2A FIELD2B.
```

## Using the STRING, UNSTRING, and INSPECT Statements

### 5.2 Separating Data Using the UNSTRING Statement

**Table 5–5 Results of Delimiting Multiple Receiving Items**

FIELD1 PIC X(8) VALUE IS:	Values After UNSTRING Operation	
	FIELD2A PIC X(3)	FIELD2B PIC X(3)
ABC*DEF*	ABC	DEF
ABCDE*FG	ABC	FG#
A*B****	A##	B##
*AB*CD**	###	AB#
**ABCDEF	###	###
A*BCDEFG	A##	BCD
ABC**DEF	ABC	###
A*****B	A##	###

Legend: # = space

The previous examples illustrate the limitations of a single-character delimiter. To overcome these limitations, a delimiter of more than one character or a delimiter preceded by the word ALL may be used.

Table 5–6 shows the results of the following UNSTRING operation using a 2-character delimiter:

```
UNSTRING FIELD1 DELIMITED BY "***"
      INTO FIELD2A FIELD2B.
```

**Table 5–6 Results of Delimiting with Two Asterisks**

FIELD1 PIC X(8) VALUE IS:	Values After UNSTRING Operation	
	FIELD2A PIC XXX	FIELD2B PIC XXX JUSTIFIED
ABC**DEF	ABC	DEF
A*B*C*D*	A*B	###
AB***C*D	AB#	C*D
AB**C*D*	AB#	*D*
AB**CD**	AB#	#CD
AB***CD*	AB#	CD*
AB*****CD	AB#	###

Legend: # = space

Unlike the STRING statement, the UNSTRING statement accepts the ALL literal as a delimiter. When the word ALL precedes the delimiter, the action of the UNSTRING statement remains essentially the same as with one delimiter until the scanning operation finds a match. At this point, the compiler scans farther, looking for additional consecutive strings of characters that also match

## Using the STRING, UNSTRING, and INSPECT Statements

### 5.2 Separating Data Using the UNSTRING Statement

the delimiter item. It considers the ALL delimiter to be one, two, three, or more adjacent repetitions of the delimiter item. Table 5–7 shows the results of the following UNSTRING operation using an ALL delimiter:

```
UNSTRING FIELD1 DELIMITED BY ALL "*"
      INTO FIELD2A FIELD2B.
```

**Table 5–7 Results of Delimiting with ALL Asterisks**

FIELD1 PIC X(8) VALUE IS:	Values After UNSTRING Operation	
	FIELD2A PIC XXX	FIELD2B PIC XXX JUSTIFIED
ABC*DEF*	ABC	DEF
ABC**DEF	ABC	DEF
A*****F	A##	##F
A*F*****	A##	##F
A*CDEFG	A##	EFG

Legend: # = space

Table 5–8 shows the results of the following UNSTRING operation that combines ALL with a 2-character delimiter:

```
UNSTRING FIELD1 DELIMITED BY ALL "***"
      INTO FIELD2A FIELD2B.
```

**Table 5–8 Results of Delimiting with ALL Double Asterisks**

FIELD1 PIC X(8) VALUE IS:	Values After UNSTRING Operation	
	PIC XX	PIC XXX JUSTIFIED
ABC**DEF	ABC	DEF
AB**DE**	AB#	#DE
A***D***	A##	*D
A*****	A##	##*

Legend: # = space

In addition to unchangeable delimiters, such as literals and figurative constants, delimiters can be designated by identifiers. Identifiers permit variable delimiting. Consider the following sample statement:

```
UNSTRING FIELD1 DELIMITED BY DEL1
      INTO FIELD2A FIELD2B.
```

The data name DEL1 must be alphanumeric; it can be either a group or an elementary item. If the delimiter contains a subscript, the subscript may vary as a side effect of the UNSTRING operation.

# Using the STRING, UNSTRING, and INSPECT Statements

## 5.2 Separating Data Using the UNSTRING Statement

### 5.2.2.1 Multiple Delimiters

The UNSTRING statement scans a sending item, searching for a match from a list of delimiters. This list can contain ALL delimiters and delimiters of various sizes. Delimiters in the list must be connected by the word OR.

The following sample statement unstrings a sending item into three receiving items. The sending item consists of three strings separated by one of the following: (1) any number of spaces, (2) a comma followed by a single space, (3) a single comma, (4) a tab character, or (5) a carriage-return character. The comma and space must precede the single comma in the list if the comma and space are to be recognized.

```
UNSTRING FIELD1 DELIMITED BY ALL SPACE
      OR ", "
      OR ",,"
      OR TAB
      OR CR
      INTO FIELD2A FIELD2B FIELD2C.
```

Table 5–9 shows the potential of this statement. The tab and carriage-return characters represent single-character items containing the ASCII horizontal tab and carriage-return characters.

**Table 5–9 Results of Multiple Delimiters**

FIELD1 PIC X(12)	FIELD2A PIC XXX	FIELD2B PIC 9999	FIELD2C PIC XXX
A,0,C <span style="border: 1px solid black; padding: 0 2px;">Return</span>	A##	0000	C##
A <span style="border: 1px solid black; padding: 0 2px;">Tab</span> 456, E	A##	0456	E##
A 3 9	A##	0003	9##
A <span style="border: 1px solid black; padding: 0 2px;">Tab</span> <span style="border: 1px solid black; padding: 0 2px;">Tab</span> B <span style="border: 1px solid black; padding: 0 2px;">Return</span>	A##	0000	B##
A,,C	A##	0000	C##
ABCD, 4321,Z	ABC	4321	Z##

Legend: # = space

### 5.2.3 Using the COUNT Phrase

The COUNT phrase keeps track of the size of the sending string and stores the length in a user-supplied data area.

The length of a delimited sending item can vary from zero to the full length of the item. Some programs require knowledge of this length. For example, some data is truncated if it exceeds the size of the receiving item, so the program's logic requires this information.

The COUNT phrase follows the receiving item. Consider the following example:

```
UNSTRING FIELD1 DELIMITED BY ALL "*"
      INTO FIELD2A COUNT IN COUNT2A
      FIELD2B COUNT IN COUNT2B
      FIELD2C.
```

The compiler generates code that counts the number of characters between the leftmost position of FIELD1 and the first asterisk in FIELD1 and places the count into COUNT2A. The delimiter is not included in the count because it is not a part of the string. The data preceding the first asterisk is then moved into FIELD2A.

## Using the STRING, UNSTRING, and INSPECT Statements

### 5.2 Separating Data Using the UNSTRING Statement

The compiler then counts the number of characters between the last contiguous asterisk in the first scan and the next asterisk in the second scan, and places the count in COUNT2B. The data between the delimiters of the second scan is moved into FIELD2B.

The third scan begins at the first character after the last contiguous asterisk in the second scan. Any data between the delimiters of this scan is moved to FIELD2C.

The COUNT phrase should be used only where it is needed. In this example, the length of the string moved to FIELD2C is not needed, so no COUNT phrase follows it.

If the receiving item is shorter than the value placed in the count item, the code truncates the sending string. If the number of integer positions in a numeric item is smaller than the value placed into the count item, high-order numeric digits have been lost. If a delimiter match is found on the first character examined, a zero is placed in the count item.

The COUNT phrase can be used only in conjunction with the DELIMITED BY phrase.

#### 5.2.4 Saving UNSTRING Delimiters Using the DELIMITER Phrase

The DELIMITER phrase causes the actual character or characters that delimited the sending item to be stored in a user-supplied data area. This phrase is most useful when:

- The UNSTRING statement contains a delimiter list.
- Any one of the delimiters in the list might have delimited the item.
- Program logic flow depends on the delimiter match found.

By using the DELIMITER and COUNT phrases, you can make the flow of program logic dependent on both the size of the sending string and the delimiter terminating the string.

To use the DELIMITER phrase, follow the receiving item name with the words DELIMITER IN and an identifier. The compiler generates code that places the delimiter character in the area named by the identifier. Consider the following sample UNSTRING statement:

```
UNSTRING FIELD1 DELIMITED BY ", "  
    OR TAB  
    OR ALL SPACE  
    OR CR  
    INTO FIELD2A DELIMITER IN DELIMA  
    FIELD2B DELIMITER IN DELIMB  
    FIELD2C.
```

After moving the first sending string to FIELD2A, the character (or characters) that delimited that string is placed in DELIMA. In this example, DELIMA contains either a comma, a tab, a carriage return, or any number of spaces. Because the delimiter string is moved under the rules of the elementary nonnumeric MOVE statement, the compiler truncates or space-fills with left or right justification.

The second sending string is then moved to FIELD2B and its delimiting character is placed into DELIMB.

## Using the STRING, UNSTRING, and INSPECT Statements

### 5.2 Separating Data Using the UNSTRING Statement

When a sending string is delimited by the end of the sending item rather than by a match on a delimiter, the delimiter string is of zero length and the DELIMITER item is space-filled. The phrase should be used only where needed. In this example, the character that delimits the last sending string is not needed, so no DELIMITER phrase follows FIELD2C.

The data item named in the DELIMITER phrase must be described as an alphanumeric item. It can contain editing characters, and it can also be a group item.

When you use both DELIMITER and COUNT phrases, the DELIMITER phrase must precede the COUNT phrase. Both of the data items named in these phrases can be subscripted or indexed. If they are subscripted, the subscript can be varied as a side effect of the UNSTRING operation.

#### 5.2.5 Controlling UNSTRING Scanning Using the POINTER Phrase

Although the UNSTRING statement scan usually starts at the leftmost position of the sending item, the POINTER phrase lets you control the character position where the scan starts. Scanning, however, remains left to right.

When a sending item is to be unstrung into multiple receiving items, the choice of delimiters and the size of subsequent receiving items depends on the size of the first sending string and the character that delimited that string. Thus, the program needs to move the first sending item, hold its scanning position in the sending item, and examine the results of the operation to determine how to handle the sending items that follow.

This is done by using an UNSTRING statement with a POINTER phrase that fills only the first receiving item. When the first string has been moved to a receiving item, the compiler begins the next scanning operation one character beyond the delimiter that caused the interruption. The program examines the new position, the receiving item, the delimiter value, and the sending string size. It resumes the scanning operation by executing another UNSTRING statement with the same sending item and pointer data item. In this way, the UNSTRING statement moves one sending string at a time, with the form of each succeeding move depending on the context of the preceding string of data.

The POINTER phrase must follow the last receiving item in the UNSTRING statement. You are responsible for initializing the pointer before the UNSTRING statement executes. Consider the following two UNSTRING statements with their accompanying POINTER phrases and tests:

```
MOVE 1 TO PNTR.
UNSTRING FIELD1 DELIMITED BY ":"
      OR TAB
      OR CR
      OR ALL SPACE
      INTO FIELD2A DELIMITER IN DELIMA COUNT IN LSIZEA
      WITH POINTER PNTR.
IF LSIZEA = 0 GO TO NO-LABEL-PROCESS.
IF DELIMA = ":"
      IF PNTR > 8 GO TO BIG-LABEL-PROCESS
      ELSE GO TO LABEL-PROCESS.
IF DELIMA = TAB GO TO BAD-LABEL PROCESS.
.
.
UNSTRING FIELD1 DELIMITED BY ... WITH POINTER PNTR.
```



## Using the STRING, UNSTRING, and INSPECT Statements

### 5.2 Separating Data Using the UNSTRING Statement

PNTR contains the current position of the scanner in the sending item. The second UNSTRING statement uses PNTR to begin scanning the additional sending strings in FIELD1.

Because the compiler considers the leftmost character to be character position 1, the value of PNTR can be used to examine the next character. To do this, describe the sending item as a table of characters and use PNTR as a sending item subscript. This is shown in the following example:

```
01 FIELD1.
   02 FIELD1-CHAR OCCURS 40 TIMES.
   .
   .
   .
   UNSTRING FIELD1
       .
       .
       .
       WITH POINTER PNTR.
   IF FIELD1-CHAR(PNTR) = "X" ...
```

Another way to examine the next character of the sending item is to use the UNSTRING statement to move the character to a 1-character receiving item:

```
UNSTRING FIELD1
   .
   .
   .
   WITH POINTER PNTR.
UNSTRING FIELD1 INTO CHAR1 WITH POINTER PNTR.
SUBTRACT 1 FROM PNTR.
IF CHAR1 = "X" ...
```

The program must decrement PNTR by 1 to work, because the second UNSTRING statement increments the pointer by 1.

The program must initialize the POINTER phrase data item before the UNSTRING statement uses it. The compiler will terminate the UNSTRING operation if the initial value of the pointer is less than one or greater than the length of the sending item. Such a pointer value causes an overflow condition. Overflow conditions are discussed in Section 5.2.7.

#### 5.2.6 Counting UNSTRING Receiving Items Using the TALLYING Phrase

The TALLYING phrase counts the number of receiving items that received data from the sending item.

When an UNSTRING statement contains several receiving items, there are not always as many sending strings as there are receiving items. The TALLYING phrase provides a convenient method for keeping a count of how many receiving items actually received strings. The following example shows how to use the TALLYING phrase:

```
MOVE 0 TO RCOUNT.
UNSTRING FIELD1 DELIMITED BY ","
   OR ALL SPACE
   INTO FIELD2A
       FIELD2B
       FIELD2C
       FIELD2D
       FIELD2E
   TALLYING IN RCOUNT.
```

## Using the STRING, UNSTRING, and INSPECT Statements

### 5.2 Separating Data Using the UNSTRING Statement

If the compiler has moved only three sending strings when it reaches the end of FIELD1, it adds 3 to RCOUNT. The first three receiving items (FIELD2A, FIELD2B, and FIELD2C) contain data from the UNSTRING operation, but the last two (FIELD2D and FIELD2E) do not.

The UNSTRING statement does not initialize the TALLYING data item. The TALLYING data item always contains the sum of its initial contents plus the number of receiving items receiving data. Thus, you might want to initialize the tally count before each use.

You can use the POINTER and TALLYING phrases together in the same UNSTRING statement, but the POINTER phrase must precede the TALLYING phrase. Both phrases must follow all of the item names, the DELIMITER phrase, and the COUNT phrase. The data items for both phrases must contain numeric integers without editing characters or the symbol P in their PICTURE character-strings; both data items can be either COMP or DISPLAY usage. They can be signed or unsigned and, if they are DISPLAY usage, they can contain any desired sign option.

#### 5.2.7 Exiting an UNSTRING Statement Using the OVERFLOW Phrase

The OVERFLOW phrase detects the overflow condition and causes an imperative statement to be executed when it detects the condition. An overflow condition exists when:

- The UNSTRING statement is about to execute and its pointer data item contains a value less than one or greater than the size of the sending item. The compiler generates code that executes the OVERFLOW phrase before it moves any data, and the values of all the receiving items remain unchanged.
- Data still remains in the sending item after the UNSTRING statement has filled all the receiving items. The compiler executes the OVERFLOW phrase after it has executed the UNSTRING statement. The value of each receiving item is updated, but some data is still unmoved.

If the UNSTRING operation causes the scan to move past the rightmost position of the sending item (thus exhausting it), the compiler does not execute the OVERFLOW phrase.

The following set of instructions causes program control to execute the UNSTRING statement repeatedly until it exhausts the sending item. The TALLYING data item is a subscript that indexes the receiving item. Compare this loop with the previous loop, which accomplishes the same thing:

```
MOVE 1 TO TLY PNTR.  
PAR1. UNSTRING FIELD1 DELIMITED BY ", "  
      OR CR  
      INTO FIELD2(TLY) WITH POINTER PNTR  
      TALLYING IN TLY  
      ON OVERFLOW GO TO PAR1.
```

#### 5.2.8 Common UNSTRING Statement Errors

The most common errors made when writing UNSTRING statements are as follows:

- Leaving the OR connector out of a delimiter list
- Misspelling or interchanging the words DELIMITED and DELIMITER
- Writing the DELIMITER and COUNT phrases in the wrong order when both are present (DELIMITER must precede COUNT)

## Using the STRING, UNSTRING, and INSPECT Statements

### 5.2 Separating Data Using the UNSTRING Statement

- Omitting the word INTO (or writing it as TO) before the receiving item list
- Repeating the word INTO in the receiving item list as shown in this example:

```
UNSTRING FIELD1 DELIMITED BY SPACE
      OR TAB
      INTO FIELD2A DELIMITER IN DELIMA
      INTO FIELD2B DELIMITER IN DELIMB
      INTO FIELD2C DELIMITER IN DELIMC.
```

- Writing the POINTER and TALLYING phrases in the wrong order (POINTER must precede TALLYING)
- Failing to understand the rules concerning subscript evaluation

### 5.3 Examining and Replacing Characters Using the INSPECT Statement

The INSPECT statement examines the character positions in an item and counts or replaces certain characters (or groups of characters) in that item.

Like the STRING and UNSTRING operations, INSPECT operations scan across the item from left to right. Included in the INSPECT statement is an optional phrase that allows scanning to begin or terminate upon detection of a delimiter match. This feature allows scanning to begin within the item, as well as at the leftmost position.

#### 5.3.1 Using the TALLYING and REPLACING Options of the INSPECT Statement

The TALLYING operation, which counts certain characters in the item, and the REPLACING operation, which replaces certain characters in the item, can be applied either to the characters in the delimited area of the item being inspected, or to only those characters that match a given character string or strings under stated conditions. Consider the following sample statements, both of which cause a scan of the complete item:

```
INSPECT FIELD1 TALLYING TLY FOR ALL "B".
INSPECT FIELD1 REPLACING ALL SPACE BY ZERO.
```

The first statement causes the compiler to scan FIELD1 looking for the character B. Each time a B is found, TLY is incremented by 1.

The second statement causes the compiler to scan FIELD1 looking for spaces. Each space found is replaced with a zero.

The TALLYING and REPLACING phrases support both single and multiple arguments. For example, both of the following statements are valid:

```
INSPECT FIELD1 TALLYING TLY FOR ALL "A" "B" "C".
INSPECT FIELD1 REPLACING ALL "A" "B" "C" BY "D".
```

You can use both the TALLYING and REPLACING phrases in the same INSPECT statement. However, when used together, the TALLYING phrase must precede the REPLACING phrase. An INSPECT statement with both phrases is equivalent to two separate INSPECT statements. In fact, the compiler compiles such a statement into two distinct INSPECT statements. To simplify debugging, write the two phrases in separate INSPECT statements.

## Using the STRING, UNSTRING, and INSPECT Statements

### 5.3 Examining and Replacing Characters Using the INSPECT Statement

#### 5.3.2 Restricting Data Inspection Using the BEFORE/AFTER Phrase

The BEFORE/AFTER phrase acts as a delimiter and can restrict the area of the item being inspected.

The following sample statement counts only the zeros that precede the percent sign (%) in FIELD1:

```
INSPECT FIELD1 TALLYING TLY
      FOR ALL ZEROS BEFORE "%".
```

The delimiter (the percent sign in the preceding sample statement) can be a single character, a string of characters, or any figurative constant. Furthermore, it can be either an identifier or a literal.

- If the delimiter is an identifier, it must be an elementary data item of DISPLAY usage. It can be alphabetic, alphanumeric, or numeric, and it can contain editing characters. The compiler always treats the item as if it had been described as an alphanumeric string. It does this by implicit redefinition of the item, as described in Section 5.3.3.
- If the delimiter is a literal, it must be nonnumeric.

The compiler repeatedly compares the delimiter characters against an equal number of characters in the item being inspected. If none of the characters matches the delimiter, or if too few characters remain in the rightmost position of the item for a full comparison, the compiler considers the comparison to be unequal.

The examples of the INSPECT statement in Figure 5–2 illustrate the way the delimiter character finds a match in the item being inspected. The underlined characters indicate the portion of the item the statement inspects as a result of the delimiters of the BEFORE and AFTER phrases. The remaining portion of the item is ignored by the INSPECT statement.

The ellipses represent the position of the TALLYING or REPLACING phrase. The compiler generates code that scans the item for a delimiter match before it scans for the inspection operation (TALLYING or REPLACING), thus establishing the limits of the operation before beginning the actual inspection. Section 5.3.4.1 further describes the separate scan.

#### 5.3.3 Implicit Redefinition

The compiler requires that certain items referred to by the INSPECT statement be alphanumeric items. If one of these items is described as another data class, the compiler implicitly redefines that item so the INSPECT statement can handle it as an alphanumeric string as follows:

- If the item is alphabetic, alphanumeric edited, or unsigned numeric, the item is redefined as alphanumeric. This is a compile-time operation; no data movement occurs at run time.
- If the item is signed numeric, the compiler generates code that first removes the sign and then redefines the item as alphanumeric. If the sign is a separate character, that character is ignored, essentially shortening the item, and that character does not participate in the implicit redefinition. If the sign is an overpunch on the leading or trailing digit, the sign value is removed and the character is left with only the numeric value that was stored in it.

## Using the STRING, UNSTRING, and INSPECT Statements

### 5.3 Examining and Replacing Characters Using the INSPECT Statement

**Figure 5–2 Matching Delimiter Characters to Characters in a Field**

Instruction	FIELD1 Value
INSPECT FIELD1...BEFORE "E".	<u>ABCDEF</u> <del>GH</del>
INSPECT FIELD1...AFTER "E".	<del>ABCDEF</del> <u>GH</u>
INSPECT FIELD1...BEFORE "K".	<u>ABCDEFGH</u> <del>I</del>
INSPECT FIELD1...AFTER "K".	<del>ABCDEF</del> <u>GH</u>
INSPECT FIELD1...BEFORE "AB".	<del>ABCDEF</del> <u>GH</u>
INSPECT FIELD1...AFTER "AB".	<u>ABCDEF</u> <del>GH</del>
INSPECT FIELD1...BEFORE "HI".	<u>ABCDEFGH</u> <del>I</del>
INSPECT FIELD1...AFTER "HI".	<del>ABCDEF</del> <u>GH</u>
INSPECT FIELD1...BEFORE "I".	<u>ABCDEFGH</u> <del>I</del>
INSPECT FIELD1...AFTER "I".	<del>ABCDEF</del> <u>GH</u>

ZK-1426A-GE

The compiler alters the digit position containing the sign before beginning the INSPECT operation and restores it to its former value after the operation. If the sign's digit position does not contain a valid ASCII signed numeric digit, redefinition causes the value to change.

Table 5–10 shows these original, altered, and restored values.

The compiler never moves an implicitly redefined item from its storage position. All redefinition occurs in place.

The position of an implied decimal point on numeric quantities does not affect implicit redefinition.

## Using the STRING, UNSTRING, and INSPECT Statements

### 5.3 Examining and Replacing Characters Using the INSPECT Statement

**Table 5–10 Values Resulting from Implicit Redefinition**

<b>Original Value</b>	<b>Altered Value</b>	<b>Restored Value</b>
} (173)	0 (60)	} (173)
A (101)	1 (61)	A (101)
B (102)	2 (62)	B (102)
C (103)	3 (63)	C (103)
D (104)	4 (64)	D (104)
E (105)	5 (65)	E (105)
F (106)	6 (66)	F (106)
G (107)	7 (67)	G (107)
H (110)	8 (70)	H (110)
I (111)	9 (71)	I (111)
{ (175)	0 (60)	{ (175)
J (112)	1 (61)	J (112)
K (113)	2 (62)	K (113)
L (114)	3 (63)	L (114)
M (115)	4 (64)	M (115)
N (116)	5 (65)	N (116)
O (117)	6 (66)	O (117)
P (120)	7 (67)	P (120)
Q (121)	8 (70)	Q (121)
R (122)	9 (71)	R (122)
0 (60)	0 (60)	} (173)
1 (61)	1 (61)	A (101)
2 (62)	2 (62)	B (102)
3 (63)	3 (63)	C (103)
4 (64)	4 (64)	D (104)

(continued on next page)

## Using the STRING, UNSTRING, and INSPECT Statements

### 5.3 Examining and Replacing Characters Using the INSPECT Statement

**Table 5–10 (Cont.) Values Resulting from Implicit Redefinition**

Original Value	Altered Value	Restored Value
5 (65)	5 (65)	E (105)
6 (66)	6 (66)	F (106)
7 (67)	7 (67)	G (107)
8 (70)	8 (70)	H (110)
9 (71)	9 (71)	I (111)
All other values	0 (60)	} (173)

#### 5.3.4 Examining the INSPECT Operation

Regardless of the type of inspection (TALLYING or REPLACING), the INSPECT statement has only one method for inspecting the characters in the item. This section analyzes the INSPECT statement and describes this inspection method.

Figure 5–3 shows an example of the INSPECT statement. The item to be inspected must be named (FIELD1 in our example), and the item name must be followed by a TALLYING phrase (TALLYING TLY). The TALLY phrase must be followed by one or more identifiers or literals (B). These identifiers or literals comprise the arguments. More than one argument makes up the argument list.

**Figure 5–3 Sample INSPECT Statement**

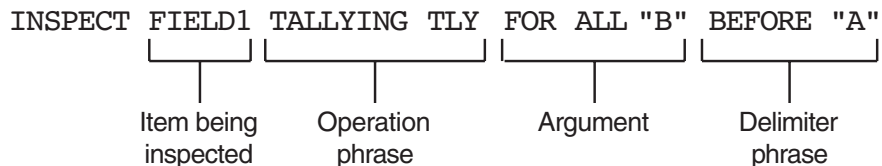

ZK-6052-GE

Each argument in an argument list can have other items associated with it. Thus, each argument that is used in a TALLYING operation must have a tally counter (such as TLY in the example) associated with it. The tally counter is incremented each time it matches the argument with a character or group of characters in the item being inspected.

Each argument in an argument list used in a REPLACING operation must have a replacement item associated with it. The compiler generates code that uses the replacement item to replace each string of characters in the item that matches the argument. Figure 5–4 shows a typical REPLACING phrase (with \$ as the replacement item).

## Using the STRING, UNSTRING, and INSPECT Statements

### 5.3 Examining and Replacing Characters Using the INSPECT Statement

Figure 5–4 Typical REPLACING Phrase

```
INSPECT FIELD1 REPLACING ALL "0" BY "$"  
                        └──────────┘  
                          |  
                        Replacing argument  
                        ZK-6053-GE
```

Each argument in an argument list used with either a TALLYING or REPLACING operation can have a delimiter item (BEFORE/AFTER phrase) associated with it. If the delimiter item is not present, the argument is applied to the entire item. If the delimiter item is present, the argument is applied only to that portion of the item specified by the BEFORE/AFTER phrase.

#### 5.3.4.1 Setting the Scanner

The INSPECT operation begins by setting the scanner to the leftmost character position of the item being inspected. It remains on this character until an argument has been matched with a character (or characters) or until all arguments have failed to find a match at that position.

#### 5.3.4.2 Active/Inactive Arguments

When an argument has a BEFORE/AFTER phrase associated with it, that argument has a delimiter and may not be eligible to participate in a comparison at every position of the scanner. Thus, each argument in the argument list has an active/inactive status at any given setting of the scanner.

For example, an argument that has an AFTER phrase associated with it starts the INSPECT operation in an inactive state. The delimiter of the AFTER phrase must find a match before the argument can participate in the comparison. When the delimiter finds a match, the compiler generates code that retains the character position beyond the matched character string; then, when the scanner reaches or passes this position, the argument becomes active. This is shown in the following example:

```
INSPECT FIELD1 TALLYING TLY  
      FOR ALL "B" AFTER "X".
```

If FIELD1 has a value of ABABXZBA, the argument B remains inactive until the scanner finds a match for delimiter X. Thus, argument B remains inactive while the compiler generates code that scans character positions 1 to 5. At character position 5, delimiter X finds a match, and because the character position beyond the matched delimiter character is the point at which the argument becomes active, argument B is compared for the first time at character position 6. It finds a successful match at character position 7, causing TLY to be incremented by 1.

Table 5–11 shows an INSPECT...TALLYING statement that is scanning FIELD1, tallying in TLY, and looking for the arguments and delimiters listed in the left column. Assume that TLY is initialized to 0.



## Using the STRING, UNSTRING, and INSPECT Statements

### 5.3 Examining and Replacing Characters Using the INSPECT Statement

**Table 5–11 Relationship Among INSPECT Argument, Delimiter, Item Value, and Argument Active Position**

Argument and Delimiter	FIELD1 Value	Argument Active at Position	Contents of TLY After Scan
ALL	BXBXXXXBB	6	2
"B" AFTER "XX"	XXXXXXXX	3	0
	BXBBBBBBXX	never	0
"X" AFTER "XX"	BXBXXBXXB	6	2
	XXXXXXXX	3	6
	BBBBBBXX	never	0
"B" AFTER "XB"	BXYBXXBXX	7	0
	XBXXBXXB	3	3
	BBBBBBXB	never	0
"BX" AFTER "XB"	XXXXBXXXX	6	0
	XXXXBBXXX	6	1
	XXBXXXXBX	4	1

When an argument has an associated BEFORE delimiter, the inactive/active states reverse roles: the argument is in an active state when the scanning begins and becomes inactive at the character position that matches the delimiter. Regardless of the presence of the BEFORE delimiter, an argument becomes inactive when the scanner approaches the rightmost position of the item and the remaining characters are fewer in number than the characters in the argument. In such a case, the argument cannot possibly find a match in the item, so it becomes inactive.

Because the BEFORE/AFTER delimiters are found on a separate scan of the item, the compiler generates code that recognizes and sets up the delimiter boundaries before it scans for an argument match; therefore, the same characters can be used as arguments and delimiters in the same phrase.

#### 5.3.4.3 Finding an Argument Match

The compiler generates code that selects arguments from the argument list in the order in which they appear in the list. If the first one it selects is an active argument, and the conditions stated in the INSPECT statement allow a comparison, the compiler generates code that compares it to the character at the scanner's position. If the active argument does not find a match, the compiler generates code that takes the next active argument from the list and compares that to the same character. If none of the active arguments finds a match, the scanner moves one position to the right and begins the inspection operation again with the first active argument in the list. The inspection operation terminates at the rightmost position of the item.

## Using the STRING, UNSTRING, and INSPECT Statements

### 5.3 Examining and Replacing Characters Using the INSPECT Statement

When an active argument finds a match, the compiler ignores any remaining arguments in the list and conducts the TALLYING or REPLACING operation on the character. The scanner moves to a new position and the next inspection operation begins with the first argument in the list. The INSPECT statement can contain additional conditions, which are described later in this section; without them, however, the argument match is allowed to take place, and inspection continues following the match.

The compiler updates the scanner by adding the size of the matching argument to it. This moves the scanner to the next character beyond the string of characters that matched the argument. Thus, once an active argument matches a string of characters, the statement does not inspect those character positions again unless program control executes the entire statement again.

#### 5.3.5 The TALLYING Phrase

An INSPECT statement that contains a TALLYING phrase counts the occurrences of various character strings under certain stated conditions. It keeps the count in a user-designated item called a tally counter.

##### 5.3.5.1 The Tally Counter

The identifier following the word TALLYING designates the tally counter. The identifier can be subscripted or indexed. The data item must be a numeric integer without any editing or P characters; it can be COMP or DISPLAY usage, and it can be signed (separate or overpunched).

Each time the tally argument matches the delimited string being inspected, the compiler adds 1 to the tally counter.

You can initialize the tally counter to any numeric value. The INSPECT statement does not initialize it.

##### 5.3.5.2 The Tally Argument

The tally argument specifies a character-string (or strings) and a condition under which that string should be compared to the delimited string being inspected.

The CHARACTERS form of the tally argument specifies that every character in the delimited string being inspected should be considered to match an imaginary character that serves as the tally argument. This increments the tally counter by a value that equals the size of the delimited string. For example, the following statement causes TLY to be incremented by the number of characters that precede the first comma, regardless of what those characters are:

```
INSPECT FIELD1 TALLYING TLY FOR  
      CHARACTERS BEFORE ", ".
```

The ALL and LEADING forms of the tally argument specify a particular character-string (or strings), which can be represented by either a literal or an identifier. The tally argument character-string can be any length; however, each character of the argument must match a character in the delimited string before the compiler considers the argument matched.

- A literal character-string must be either nonnumeric or a figurative constant (other than ALL literal). A figurative constant, such as SPACE or ZERO, represents a single character and can be written as " " or 0 with the same effect.

## Using the STRING, UNSTRING, and INSPECT Statements

### 5.3 Examining and Replacing Characters Using the INSPECT Statement

- An identifier must be an elementary item of DISPLAY usage. It can be any data class. However, if it is not alphanumeric, the compiler performs an implicit redefinition of the item. This redefinition is identical to the BEFORE/AFTER delimiter redefinition discussed in Section 5.3.2.

The words ALL and LEADING supply conditions that further delimit the inspection operation:

- ALL specifies that every match that the search argument finds in the delimited character string be counted in the tally counter. When a literal follows the word ALL, it does not have the same meaning as the figurative constant, ALL literal. The ALL literal meaning of ALL “,” is a string of consecutive commas (as many as the context of the statement requires). ALL “,” used as a tally argument means “count each comma without regard to adjacent characters.”
- LEADING specifies that only adjacent matches of the TALLY argument at the leftmost position of the delimited character string be counted. At the first failure to match the tally argument, the compiler terminates counting and causes the argument to become inactive. The sample statement INSPECT...TALLYING (scanning FIELD1, tallying in TLY, and looking for the arguments and delimiters listed in the left column) gives the results in Table 5–12 (if the program initializes TLY to 0).

**Table 5–12 LEADING Delimiter of the Inspection Operation**

Argument and Delimiter	FIELD1 Value	Contents of TLY After Scan
LEADING “*” AFTER “0”.	F**0**F	2
	F**0F**	0
	F**F**0	0
	0***F**	3
LEADING “***” AFTER “0”.	F**0**F***	1
	F**F0***FF	1
	F**F0***F**	2
	F**F**0*	0

#### 5.3.5.3 The Tally Argument List

One INSPECT...TALLYING statement can contain more than one tally argument, and each argument can have a separate BEFORE/AFTER phrase and tally counter associated with it. These tally arguments with their associated tally counters and BEFORE/AFTER phrases form an argument list. The manner in which this list is processed affects the action of any given tally argument.

The following examples show INSPECT statements with argument lists. The text with each example explains how that list is processed.

```
INSPECT FIELD1 TALLYING T FOR
    ALL ", "
    ALL ". "
    ALL ";".
```

## Using the STRING, UNSTRING, and INSPECT Statements

### 5.3 Examining and Replacing Characters Using the INSPECT Statement

These three tally arguments have the same tally counter, T, and are active over the entire item being inspected. Thus, the preceding statement adds the total number of commas, periods, and semicolons in FIELD1 to the initial value of T. Because the TALLYING phrase supports multiple arguments and only one counter is used, the previous statement could have been written as follows:

```
INSPECT FIELD1 TALLYING T FOR ALL "," ". " ";".
```

```
INSPECT FIELD1 TALLYING
  T1 FOR ALL ","
  T2 FOR ALL "."
  T3 FOR ALL ";".
```

Each tally argument in this statement has its own tally counter and is active over the entire item being inspected. Thus, the preceding statement adds the total number of commas in FIELD1 to the initial value of T1, the total number of periods to the initial value of T2, and the number of semicolons to T3.

```
INSPECT FIELD1 TALLYING
  T1 FOR ALL "," AFTER "A"
  T2 FOR ALL "." BEFORE "B"
  T3 FOR ALL ";".
```

Each tally argument in the preceding statement has its own tally counter; the first two arguments have delimiter phrases, and the last one is active over the entire item being inspected. Thus, the first argument is initially inactive and becomes active only after the scanner encounters an A; the second argument begins the scan in the active state but becomes inactive after a B has been encountered; and the third argument is active during the entire scan of FIELD1.

Table 5–13 shows various values of FIELD1 and the contents of the three tally counters after the scan of the previous statements. Assume that the counters are initialized to 0 before the INSPECT statement.

**Table 5–13 Results of the Scan with Separate Tallies**

FIELD1 Value	Contents of Tally Counters After Scan		
	T1	T2	T3
A.C;D.E,F	1	2	1
A.B.C.D	0	1	0
A,B,C,D	3	0	0
A;B;C;D	0	0	3
*,B,C,D	0	0	0

The BEFORE/AFTER phrase applies only to the argument that precedes it and delimits the item for that argument only. Each BEFORE/AFTER phrase causes a separate scan of the item to determine the limits of the item for its corresponding argument.

## Using the STRING, UNSTRING, and INSPECT Statements

### 5.3 Examining and Replacing Characters Using the INSPECT Statement

#### 5.3.5.4 Interference in Tally Argument Lists

When several tally arguments contain one or more identical characters active at the same time, they may interfere with each other, so that when one of the arguments finds a match, the scanner steps past any other matching characters, preventing those characters from being considered for a match.

The following two identical tally arguments do not interfere with each other because they are not active at the same time. The first A in FIELD1 causes the first argument to become inactive and the second argument to become active:

```
MOVE 0 TO T1 T2.  
INSPECT FIELD1 TALLYING  
    T1 FOR ALL "," BEFORE "A"  
    T2 FOR ALL "," AFTER "A".
```

However, the next identical tally arguments interfere with each other since both are active at the same time:

```
INSPECT FIELD1 TALLYING  
    T1 FOR ALL ","  
    T2 FOR ALL "," AFTER "A".
```

For any given position of the scanner, the arguments are applied to FIELD1 in the order in which they appear in the statement. When one of them finds a match, the scanner moves to the next position and ignores the remaining arguments in the argument list. Each comma in FIELD1 causes T1 to be incremented by 1 and the second argument to be ignored. Thus, T1 always contains an accurate count of all the commas in FIELD1, and T2 is always unchanged.

The following INSPECT statement arguments only partially interfere with each other:

```
INSPECT FIELD1 TALLYING  
    T2 FOR ALL "," AFTER "A"  
    T1 FOR ALL ",".
```

The first argument does not become active until the scanner encounters an A. The second argument tallies all commas that precede the A. After the A, the first argument counts all commas and causes the second argument to be ignored. Thus, T1 contains the number of commas that precede the first A, and T2 contains the number of commas that follow the first A. This statement works well as written, but it could be difficult to debug.

The following three examples show that one INSPECT statement cannot count any character more than once. Thus, when you use the same character in more than one argument of an argument list, consider the possibility of interference and choose the order of the arguments carefully. The solution may require two or more INSPECT statements. Consider the following problem:

```
INSPECT FIELD1 TALLYING  
    T1 FOR ALL "AB"  
    T2 FOR ALL "BC".
```

If FIELD1 contains ABCABC after the scan, T1 is incremented by 2, and T2 is unaltered. The successful matching of the argument includes each B in the item. Each match resets the scanner to the character position to the right of the B, so that the second argument is never successfully matched. The results remain the same even if the order of the arguments is reversed. Only separate INSPECT statements can develop the desired counts.

## Using the STRING, UNSTRING, and INSPECT Statements

### 5.3 Examining and Replacing Characters Using the INSPECT Statement

Sometimes you can use the interference characteristics of the INSPECT statement to your advantage. Consider the following sample argument list:

```
MOVE 0 TO T4 T3 T2 T1.
INSPECT FIELD1 TALLYING
    T4 FOR ALL "****"
    T3 FOR ALL "***"
    T2 FOR ALL "**"
    T1 FOR ALL "*".
```

The argument list counts all of the asterisks in FIELD1 in four different tally counters. T4 counts the number of times that four asterisks occur together; T3 counts the number of times three asterisks appear together; T2 counts double asterisks; and T1 counts singles.

If FIELD1 contains a string of more than four consecutive asterisks, the argument list breaks the string into groups of four and counts them in T4. It then counts the less-than-four remainder in T3, T2, or T1.

Reversing the order of the arguments in this list causes T1 to count all of the asterisks, and T2, T3, and T4 to remain unchanged.

When the LEADING condition is used with an argument in the argument list, that argument becomes inactive as soon as it fails to be matched in the item being inspected. Therefore, when two arguments in an argument list contain one or more identical characters and one of the arguments has a LEADING condition, the argument with the LEADING condition should appear first. Consider the following sample statement:

```
MOVE 0 TO T1 T2.
INSPECT FIELD1 TALLYING
    T1 FOR LEADING "*"
    T2 FOR ALL "*".
```

T1 counts only leading asterisks in FIELD1; the occurrence of any other character causes the first tally argument to become inactive. T2 keeps a count of any remaining asterisks in FIELD1.

Reversing the order of the arguments in the following statement results in an argument list that can never increment T1:

```
INSPECT FIELD1 TALLYING
    T2 FOR ALL "*"
    T1 FOR LEADING "*".
```

If the first character in FIELD1 is not an asterisk, neither argument can match it, and the second argument becomes inactive. If the first character in FIELD1 is an asterisk, the first argument matches it and causes the second argument to be ignored. The first character in FIELD1 that is not an asterisk fails to match the first argument, and the second argument becomes inactive because it has not found a match in any of the preceding characters.

An argument with both a LEADING condition and a BEFORE phrase can sometimes successfully delimit the item being inspected, as in the following example:

```
MOVE 0 TO T1 T2.
INSPECT FIELD1 TALLYING
    T1 FOR LEADING SPACES
    T2 FOR ALL " " BEFORE "."
    T2 FOR ALL " " BEFORE ","
    T2 FOR ALL " " BEFORE ".".
IF T2 > 0 ADD 1 TO T2.
```

## Using the STRING, UNSTRING, and INSPECT Statements

### 5.3 Examining and Replacing Characters Using the INSPECT Statement

These statements count the number of words in the English statement in FIELD1, assuming that no more than three spaces separate the words in the sentence, that the sentence ends with a period, and that the period immediately follows the last word. When FIELD1 has been scanned, T2 contains the number of spaces between the words. Because a count of the spaces renders a number that is one less than the number of words, the conditional statement adds 1 to the count.

The first argument removes any leading spaces, counting them in a different tally counter. This shortens FIELD1 by preventing the application of the second to the fourth arguments until the scanner finds a nonspace character. The BEFORE phrase on each of the other arguments causes them to become inactive when the scanner reaches the period at the end of the sentence. Thus, the BEFORE phrases shorten FIELD1 by making the second to the fourth arguments inactive before the scanner reaches the rightmost position of FIELD1. If the sentence in FIELD1 is indented with tab characters instead of spaces, a second LEADING argument can count the tab characters. For example:

```
INSPECT FIELD1 TALLYING
      T1 FOR LEADING SPACES
      T1 FOR LEADING TAB
      T2 FOR ALL "    "
      .
      .
      .
```

When an argument list contains a CHARACTERS argument, it should be the last argument in the list. Because the CHARACTERS argument always matches the item, it prevents the application of any arguments that follow in the list. However, as the last argument in an argument list, it can count the remaining characters in the item being inspected. Consider the following example.

```
MOVE 0 TO T1 T2 T3 T4 T5.
INSPECT FIELD1 TALLYING
      T1 FOR LEADING SPACES
      T2 FOR ALL "." BEFORE ","
      T3 FOR ALL "+" BEFORE ","
      T4 FOR ALL "-" BEFORE ","
      T5 FOR CHARACTERS BEFORE ",".
```

If FIELD1 is known to contain a number in the form frequently used to input data, it can contain a plus or minus sign, and a decimal point; furthermore, the number can be preceded by spaces and terminated by a comma. When this statement is compiled and executed, it delivers the following results:

- T1 contains the number of leading spaces.
- T2 contains the number of periods.
- T3 contains the number of plus signs.
- T4 contains the number of minus signs.
- T5 contains the number of remaining characters (assumed to be numeric).

The sum of T1 to T5, plus 1, gives the character position occupied by the terminating comma.

## Using the STRING, UNSTRING, and INSPECT Statements

### 5.3 Examining and Replacing Characters Using the INSPECT Statement

#### 5.3.6 Using the REPLACING Phrase

When an INSPECT statement contains a REPLACING phrase, that statement selectively replaces characters or groups of characters in the designated item.

The REPLACING phrase names a search argument of one or more characters and a condition under which the string can be applied to the item being inspected. Associated with the search argument is the replacement value, which must be the same length as the search argument. Each time the search argument finds a match in the item being inspected, under the condition stated, the replacement value replaces the matched characters.

A BEFORE/AFTER phrase can be used to delimit the area of the item being inspected. A search argument applies only to the delimited area of the item.

##### 5.3.6.1 The Search Argument

The search argument of the REPLACING phrase names a character string and a condition under which the character string should be compared to the delimited string being inspected.

The CHARACTERS form of the search argument specifies that every character in the delimited string being inspected should be considered to match an imaginary character that serves as the search argument. Thus, the replacement value replaces each character in the delimited string. For example:

```
INSPECT ITEM REPLACING CHARACTERS ...
```

The ALL, LEADING, and FIRST forms of the search argument specify a particular character string, which can be represented by a literal or an identifier. The search argument character string can be any length. However, each character of the argument must match a character in the delimited string before the compiler considers the argument matched. For example:

```
INSPECT ITEM REPLACING ALL ...
```

The necessary literal and identifier characteristics are as follows:

- A literal character string must be either nonnumeric or a figurative constant (other than ALL literal). A figurative constant, such as SPACE or ZERO, represents a single character and can be written as “ ” or “0” with the same effect. Because a figurative constant represents a single character, the replacement value must be one character long.
- An identifier must represent an elementary item of DISPLAY usage. It can be any class. However, if it is not alphabetic, the compiler performs an implicit redefinition of the item. This redefinition is identical to the BEFORE/AFTER delimiter redefinition discussed in Section 5.3.2.

The words ALL, LEADING, and FIRST supply conditions that further delimit the inspection operation:

- ALL specifies that each match the search argument finds in the delimited character string is replaced by the replacement value. When a literal follows the word ALL, it does not have the same meaning as the figurative constant, ALL literal. The figurative constant meaning of ALL “,” is a string of consecutive commas, as many as the context of the statement requires. ALL “,” as a search argument of the REPLACING phrase means “replace each comma without regard to adjacent characters.”



## Using the STRING, UNSTRING, and INSPECT Statements

### 5.3 Examining and Replacing Characters Using the INSPECT Statement

- LEADING specifies that only adjacent matches of the search argument at the leftmost position of the delimited character-string be replaced. At the first failure to match the search argument, the compiler terminates the replacement operation and causes the argument to become inactive.
- FIRST specifies that only the leftmost character string that matches the search argument be replaced. After the replacement operation, the search argument containing this condition becomes inactive.

#### 5.3.6.2 The Replacement Value

Whenever the search argument finds a match in the item being inspected, the matched characters are replaced by the replacement value. The word BY followed by an identifier or literal specifies the replacement value. For example:

```
INSPECT ITEMA REPLACING ALL "A" BY "X" ALL "D" BY "X".
```

The replacement value must always be the same size as its associated search argument.

If the replacement value is a literal character-string, it must be either a nonnumeric literal or a figurative constant (other than ALL literal). A figurative constant represents as many characters as the length of the search argument requires.

If the replacement value is an identifier, it must be an elementary item of DISPLAY usage. It can be any class. However, if it is not alphanumeric, the compiler conducts an implicit redefinition of the item. This redefinition is the same as the BEFORE/AFTER redefinition discussed in Section 5.3.2.

#### 5.3.6.3 The Replacement Argument

The replacement argument consists of the search argument (with its condition and character-string), the replacement value, and an optional BEFORE/AFTER phrase, as shown in Figure 5-5.

**Figure 5-5 The Replacement Argument**

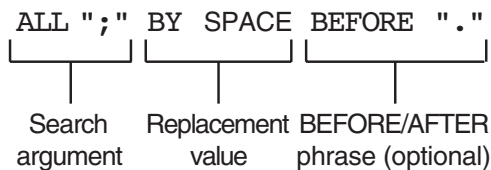

ZK-6054-GE

#### 5.3.6.4 The Replacement Argument List

One INSPECT...REPLACING statement can contain more than one replacement argument. Several replacement arguments form an argument list, and the manner in which the list is processed affects the action of any given replacement argument.

The following examples show INSPECT statements with replacement argument lists. The text following each one tells how that list will be processed.

## Using the STRING, UNSTRING, and INSPECT Statements

### 5.3 Examining and Replacing Characters Using the INSPECT Statement

```
INSPECT FIELD1 REPLACING
  ALL "," BY SPACE
  ALL "." BY SPACE
  ALL ";" BY SPACE.
```

The previous three replacement arguments all have the same replacement value, SPACE, and are active over the entire item being inspected. The statement replaces all commas, periods, and semicolons with space characters and leaves all other characters unchanged.

```
INSPECT FIELD1 REPLACING
  ALL "0" BY "1"
  ALL "1" BY "0".
```

Each of these two replacement arguments has its own replacement value and is active over the entire item being inspected. The statement exchanges zeros for 1s and 1s for zeros. It leaves all other characters unchanged.

```
INSPECT FIELD1 REPLACING
  ALL "0" BY "1" BEFORE SPACE
  ALL "1" BY "0" BEFORE SPACE.
```

---

#### Note

---

When a search argument finds a match in the item being inspected, the code replaces that character-string and scans to the next position beyond the replaced characters. It ignores the remaining arguments and applies the first argument in the list to the character-string in the new position. Thus, it never inspects the new value that was supplied by the replacement operation. Because of this, the search arguments can have the same values as the replacement arguments with no chance of interference.

---

The statement also exchanges zeros and 1s. Here, however, the first space in FIELD1 causes both arguments to become inactive.

```
INSPECT FIELD1 REPLACING
  ALL "0" BY "1" BEFORE SPACE
  ALL "1" BY "0" BEFORE SPACE
  CHARACTERS BY "*" BEFORE SPACE.
```

The first space causes the three replacement arguments to become inactive. This argument list exchanges zeros for 1s, 1s for zeros, and asterisks for all other characters in the delimited area. If the BEFORE phrase is removed from the third argument, that argument will remain active across all of FIELD1. Within the area delimited by the first space character, the third argument replaces all characters except 1s and zeros with asterisks. Beyond this area, it replaces all characters (including the space that delimited FIELD1 for the first two arguments, and any zeros and 1s) with asterisks.

#### 5.3.6.5 Interference in Replacement Argument Lists

When several search arguments, all active at the same time, contain one or more identical characters, they can interfere with each other—and consequently affect the replacement operation. This interference is similar to the interference that occurs between tally arguments.

The action of a search argument is never affected by the BEFORE/AFTER delimiters of other arguments, because the compiler scans for delimiter matches before it scans for replacement operations.

## Using the STRING, UNSTRING, and INSPECT Statements

### 5.3 Examining and Replacing Characters Using the INSPECT Statement

The action of a search argument is never affected by the characters of any replacement value, because the scanner does not inspect the replaced characters again during execution of the INSPECT statement. Interference between search arguments, therefore, depends on the order of the arguments, the values of the arguments, and the active/inactive status of the arguments. The discussion in Section 5.3.5.4 about interference in tally argument lists generally applies to replacement arguments as well.

The following rules help minimize interference in replacement argument lists:

1. Place search arguments with LEADING or FIRST conditions at the start of the list.
2. Place any arguments with the CHARACTERS condition at the end of the list.
3. Consider the order of appearance of any search arguments that contain identical characters.

#### 5.3.7 Using the CONVERTING Option

When an INSPECT statement contains a CONVERTING phrase, that statement selectively replaces characters or groups of characters in the designated item; it executes as if it were a Format 2 INSPECT statement with a series of ALL phrases. (Refer to the INSPECT statement formats in the *HP COBOL Reference Manual*.)

An example of the use of the CONVERTING phrase follows:

```
IDENTIFICATION DIVISION.
PROGRAM-ID.  PROGX.
ENVIRONMENT DIVISION.
DATA DIVISION.
WORKING-STORAGE SECTION.
01 X PIC X(28).
PROCEDURE DIVISION.
A.
    MOVE "ABC*ABC*ABC ABC@ABCABC" TO X.
    INSPECT X CONVERTING "ABC" TO "XYZ"
        AFTER "*" BEFORE "@".
    DISPLAY X.
    STOP RUN.

X before INSPECT executes      X after INSPECT executes
ABC*ABC*ABC ABC@ABCABC        ABC*XYZ*XYZ XYZ@ABCABC
```

#### 5.3.8 Common INSPECT Statement Errors

Programmers most commonly make the following errors when writing INSPECT statements:

- Leaving the FOR out of an INSPECT..TALLYING statement
- Using the word WITH instead of BY in the REPLACING phrase
- Failing to initialize the tally counter
- Omitting the word ALL before the comparison character-string



---

## Processing Files and Records

The HP COBOL I/O system offers you a wide range of record management techniques while remaining transparent to you. You can select one of several file organizations and access modes, each of which is suited to a particular application. The file organizations available through HP COBOL are sequential, line sequential, relative, and indexed. The access modes are sequential, random, and dynamic.

This chapter introduces you to the following HP COBOL I/O features:

- Defining files and records (Section 6.1)
- Identifying files and records from your HP COBOL program (Section 6.2)
- Creating and processing files (Section 6.3)
- Reading files (Section 6.4)
- Updating files (Section 6.5)
- Backing up your files (Section 6.6)

For information about low-volume or terminal screen I/O using the ACCEPT and DISPLAY statements, see Chapter 11 and refer to the *HP COBOL Reference Manual*.

The operating system provides you with I/O services for handling, controlling, and spooling your I/O needs or requests. HP COBOL, through the I/O system, provides you with extensive capabilities for data storage, retrieval, and modification.

On the OpenVMS Alpha and OpenVMS I64 operating systems, the HP COBOL I/O system consists of the Run-Time Library (RTL), which accesses Record Management Services (RMS). (On OpenVMS VAX, COBOL-generated code accesses RMS directly.) Refer to the *OpenVMS Record Management Utilities Reference Manual* and the *OpenVMS Record Management Services Reference Manual* for more information about RMS. ♦

On the Tru64 UNIX operating system, the HP COBOL I/O system consists of the Run-Time Library (RTL) and facilities of Tru64 UNIX. In addition, the facilities of a third-party ISAM package are required for any use of ORGANIZATION INDEXED. ♦

### 6.1 Defining Files and Records

A **file** is a collection of related records. You can specify the organization and size of a file as well as the record format and physical record size. The system creates a file with these characteristics and stores them with the file. Any program that accesses a file must specify the same characteristics as those that the system stored for that file when creating it.

## Processing Files and Records

### 6.1 Defining Files and Records

A **record** is a group of related data elements. The space a record needs on a physical device depends on the file organization, the record format, and the number of bytes the record contains.

File organization is described in Section 6.1.1. Record format is described in Section 6.1.2.

#### 6.1.1 File Organization

HP COBOL supports the following four types of file organization:

- **SEQUENTIAL**—This organization requires that records be referenced in sequence from the first record to the last. This organization is useful for programs that normally access each record serially. (See the Sequential File Organization section in this chapter.)
- **LINE SEQUENTIAL (Alpha, I64)**— This organization is essentially the same as sequential. Line sequential allows you to treat files as collections of variable length records, with each record containing one line of printable characters. This organization is useful for programs that access files created by text editors and similar programs. (See the Line Sequential File Organization (Alpha, I64) section in this chapter.) ♦
- **RELATIVE**—This organization lets you access records randomly, or sequentially by record number values. While this organization is more flexible than sequential organization, it is less flexible than indexed organization because you cannot insert a record in the middle of your file unless you have an empty cell to contain it. (See the Relative File Organization section in this chapter.)
- **INDEXED**—This organization lets you access records randomly or sequentially, by primary and alternate key values. This is a useful way to organize a file in which records will be added, changed, or deleted upon demand. (See the Indexed File Organization section in this chapter.)

---

#### Note

---

On Tru64 UNIX, a third-party product is required for INDEXED runtime support. Refer to the *Read Before Installing . . .* letter for up-to-date details on how to obtain the INDEXED runtime support. ♦

---

Table 6–1 summarizes the advantages and disadvantages of these file organizations.

**Table 6–1 HP COBOL File Organizations—Advantages and Disadvantages**

File Organizations	Advantages	Disadvantages
Sequential	Uses disk and memory efficiently Provides optimal usage if the application accesses all records sequentially on each run	Allows sequential access only Allows records to be added only to the end of a file

(continued on next page)

**Table 6–1 (Cont.) HP COBOL File Organizations—Advantages and Disadvantages**

File Organizations	Advantages	Disadvantages
Line Sequential (Alpha, I64)	Provides the most flexible record format	
	Allows READ/WRITE sharing	
	Allows data to be stored on many types of media, in a device-independent manner	
	Allows easy file extension	
Relative	Most efficient storage format	Allows sequential access only
	Compatible with text editors	Used for printable characters only Open Mode I/O is not allowed
Indexed	Allows sequential, random, and dynamic access	Allows data to be stored on disk only
	Provides random record deletion and insertion	Requires that record cells be the same size
Indexed	Allows READ/WRITE sharing	
	Allows sequential, random, and dynamic access	Allows data to be stored on disk only
	Allows random record deletion and insertion on the basis of a user-supplied key	Requires more disk space
	Allows READ/WRITE sharing	Uses more memory to process records
	Allows variable-length records to change length on update	Generally requires multiple disk accesses to randomly process a record
	Allows easy file extension	

**Sequential File Organization**

Sequential input/output, in which records are written and read in sequence, is the simplest and most common form of I/O. It can be performed on all I/O devices, including magnetic tape, disk, terminals, and line printers.

Sequential files consist of records that are arranged in the order in which they were written to the file. Figure 6–1 illustrates sequential file organization.

**Figure 6–1 Sequential File Organization**

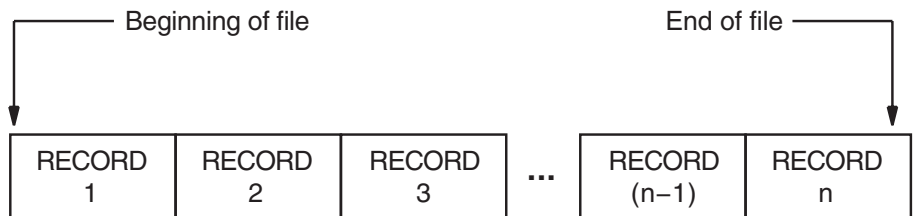

ZK-6055-GE

## Processing Files and Records

### 6.1 Defining Files and Records

Sequential files always contain an end-of-file (EOF) indication. On magnetic tapes, it is the EOF mark; on disk, it is a counter in the file header that designates the end of the file. HP COBOL statements can write over the EOF mark and, thus, extend the length of the file. Because the EOF indicates the end of useful data, HP COBOL provides no method for reading beyond it, even though the amount of space reserved for the file exceeds the amount actually used.

Occasionally a file with sequential organization, for example, a multiple-reel magnetic tape file, is so large that it requires more than one volume. An end-of-volume (EOV) label marks the end of recorded information on each volume and signals the file system to switch to a new volume. On multiple-volume files, the EOF mark appears only once, at the end of the last record on the last volume. Figure 6–2 depicts a multiple-volume, sequential file.

**Figure 6–2 A Multiple-Volume, Sequential File**

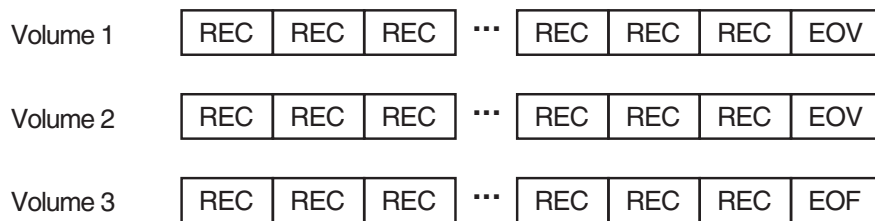

ZK-6056-GE

When you select the medium for your sequential file, consider the following:

- Speed of access—Tape is significantly slower than disk. In general, most removable media storage (magnetic, optical, and so forth) devices are slower than your fixed disks.
- Frequency of use—Use removable media devices to store relatively static files, and save your fixed disk space for more dynamic files.
- Cost—Fixed disks are generally more expensive than removable media devices. The more frequently you plan to access the data, the easier it is to justify maintaining the data on your fixed disks. For example, data that is accessed daily must be kept on readily available disks; quarterly or annual data could be offloaded to removable media.
- Transportability—Use removable media if you need to use the file across systems that have no common disk devices (this technique is commonly referred to as “sneakernetting”).

Refer to the *OpenVMS I/O User's Reference Manual* or the `ltf(4)` manpage for more information on magnetic tape formats.

#### **Line Sequential File Organization (Alpha, I64)**

Line sequential file structure is essentially similar to the structure of sequential files, with the major difference being record length. Figure 6–3 illustrates line sequential file organization.



Figure 6-3 Line Sequential File Organization (Alpha, I64)

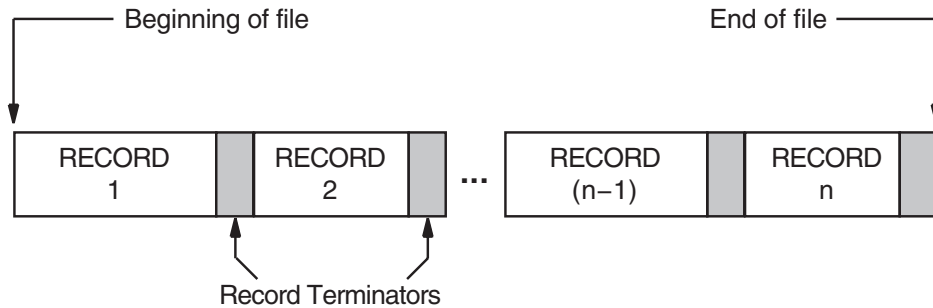

ZK-6813A-GE

A line sequential file consists of records of varying lengths arranged in the order in which they were written to the file. Each record is terminated with a “newline” character. The newline character is a line feed record terminator ('0A' hex).

Each record in a line sequential file should contain only printable characters and should not be written with a WRITE statements that contains either a BEFORE ADVANCING or AFTER ADVANCING statement.

Record length is determined by the maximum record length in the FD entry in the FILE-CONTROL section and the number of characters in a line (not including the record terminator).

When your HP COBOL program reads a line from a line sequential file that is shorter than the record area, it reads up to the record terminator, discards the record terminator, and pads the rest of the record with a number of spaces necessary to equal the record's specified length. When your program reads a line from a line sequential file that is longer than the record area, it reads the number of characters necessary to fill the record area. The next READ, if any, will begin at the next printable character in the file that is not a record terminator.

Line sequential file organization is useful in reading and printing files that were created by an editor or word processor, which typically do not write fixed-length records. ♦

### Relative File Organization

A relative file consists of fixed-size record cells and uses a key to retrieve its records. The key, called a **relative key**, is an integer that specifies the record's storage cell or record number within the file. It is analogous to the subscript of a table. Relative file processing is available only on disk devices.

Any record on a relative file (unlike a sequential file) can be accessed with one READ operation. Also, relative files allow the program to read forward with respect to the current relative key. In addition to random access by relative key, relative files also permit you to delete and update records by relative key. Relative files are used primarily when records must be accessed in random order and the records can easily be associated with numbers that give the relative positions in the file.

In relative file organization, not every cell must contain a record. Although each cell occupies one record space, a field preceding the record on the storage medium indicates whether or not that cell contains a valid record. Thus, a file can contain fewer records than it has cells, and the empty cells can be anywhere in the file.

## Processing Files and Records

### 6.1 Defining Files and Records

The numerical order of the cells remains the same during all operations on a relative file. However, accessing statements can move a record from one cell to another, delete a record from a cell, insert new records into empty cells, or rewrite existing cells.

With relative file processing, the I/O system organizes a file as a series of fixed-sized record cells. Cell size is based on the size specified as the maximum permitted length for a record in the file. The I/O system considers these cells as successively numbered from 1 (the first) to  $n$  (the last). A cell's relative record number (RRN) represents its location relative to the beginning of the file.

Because cell numbers in a relative file are unique, they can be used to identify both the cell and the record (if any) occupying that cell. Thus, record number 1 occupies the first cell in the file, record number 21 occupies the twenty-first cell, and so forth. Figure 6-4 illustrates relative file organization.

**Figure 6-4 Relative File Organization**

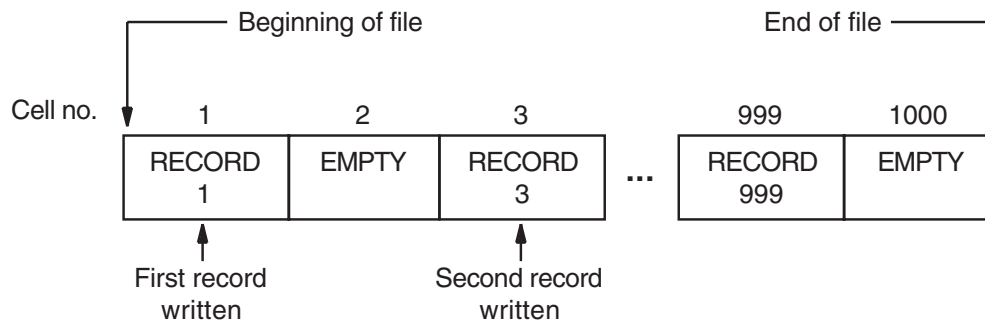

ZK-6057-GE

Relative files are used like tables. Their advantage over tables is that their size is limited to disk space rather than memory space. Also, their information can be saved from run to run. Relative files are best for records that are easily associated with ascending, consecutive numbers (so that the program conversion from data to cell number is easy), such as months (record keys 1 to 12), or the 50 U.S. states (record keys 1 to 50).

#### Indexed File Organization

An indexed file uses primary and alternate keys in the record to retrieve the contents of that record. HP COBOL allows sequential, random, and dynamic access to records. You access each record by one of its primary or alternate keys. Indexed file processing is available only on disk devices.

Unlike the sequential ordering of records in a sequential file or the relative positioning of records in a relative file, the physical location of records in indexed file organization is transparent to the program. You can add new records to an indexed file without recreating the file. You can also delete records, making room for new records.

Indexed file organization allows you to use a key to uniquely identify a record within the file. The location and length of the key are identical in all records. When creating an indexed file, you must select the data items to be the keys. Selecting such a data item indicates to the I/O system that the contents (key value) of that data item in any record written to the file can be used by the

## Processing Files and Records

### 6.1 Defining Files and Records

program to identify that record for subsequent retrieval. For more information, refer to the Environment Division clauses `RECORD KEY IS` and `ALTERNATE RECORD KEY IS` in the *HP COBOL Reference Manual*.

You must define at least one main key, called the **primary key**, for an indexed file. You may also optionally define from 1 to 254 additional keys called **alternate keys**. Each alternate key represents an additional data item in each record of the file. You can also use the key value in any of these alternate keys as a means of identifying the record for retrieval.

You define primary and alternate key values in the Record Description entry. Primary and alternate key values need not be unique if you specify the `WITH DUPLICATES` phrase in the file description entry (FD). When duplicate key values are present, you can retrieve the first record written in the logical sort order of the records with the same key value and any subsequent records using the `READ NEXT` phrase. The logical sort order controls the order of sequential processing of the record. (For more information about retrieving records with duplicate key values, refer to the information about the `READ` statement in the *HP COBOL Reference Manual*.)

When you open a file, you must specify the same number and type of keys that were specified when the file was created. (This situation is subject to modification by the check duplicate keys and relax key checking options, as well as a duplicate key specification on an FD.) If the number or type of keys does not match, the system will issue a run-time diagnostic when you try to open the file.

As your program writes records into an indexed file, the I/O system locates the values contained in the primary and alternate keys. The I/O system builds these values into a tree-structured table or **index**, which consists of a series of entries. Each entry contains a key value copied from a record. With each key value is a pointer to the location in the file of the record from which the value was copied.

Figure 6–5 shows the general structure of an indexed file defined with a primary key only.

**Figure 6–5 Indexed File Organization**

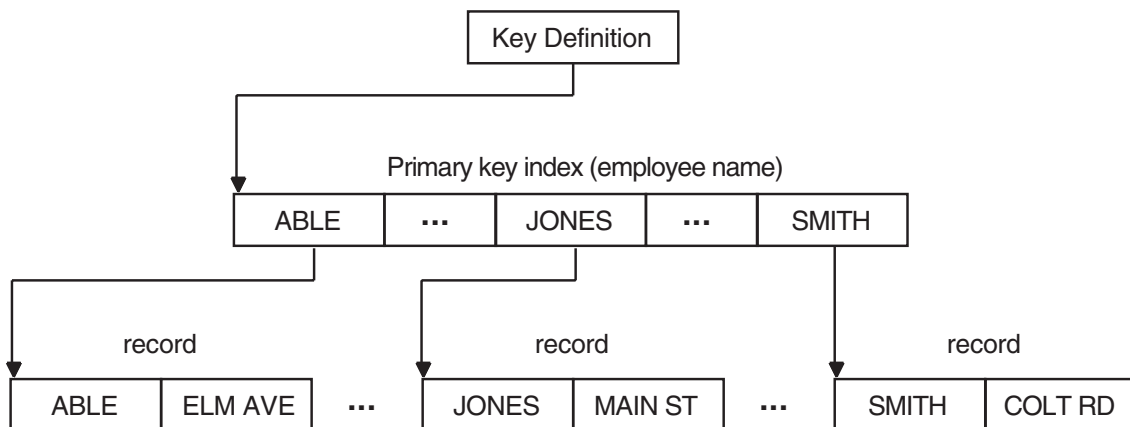

ZK-6058-GE

For a more detailed explanation of indexed file structure on OpenVMS systems, refer to the *Guide to OpenVMS File Applications*. ♦

## Processing Files and Records

### 6.1 Defining Files and Records

For information about specifying file organization in your program, see Section 6.2.2.

#### 6.1.2 Record Format

HP COBOL provides four record format types: fixed, variable, print-control, and stream. Table 6–2 shows the record format availability.

**Table 6–2 Record Format Availability**

	Sequential		Line Sequential	Relative	Indexed
	Disk	Tape			
Fixed length	yes	yes	no	yes	yes
Variable length	yes	yes	no	yes	yes
Print control	yes	no	no	no	no
Stream	no	no	yes	no	no

The compiler determines the record format from the information that you specify as follows:

- Fixed record format—Use the `RECORD CONTAINS` clause. This is the HP COBOL default.
- Variable record format—Use the `RECORD CONTAINS TO` clause or the `RECORD VARYING` clause.
- Print-control (VFC on OpenVMS systems or ASCII on Tru64 UNIX systems)—use the Procedure Division `ADVANCING` phrase, the Environment Division `APPLY PRINT-CONTROL` or (on Tru64 UNIX) `ASSIGN TO PRINTER` clauses, or the Data Division `LINAGE` clause, or use Report Writer statements and phrases.
- Stream (Alpha, I64 only)—Use the `FILE-CONTROL ORGANIZATION IS LINE SEQUENTIAL` clause. On OpenVMS Alpha and OpenVMS I64 you also get this format with `/NOVFC`. ♦

If a file has more than one record description, the different record descriptions automatically share the same record area in memory. The I/O system does not clear this area before it executes the `READ` statement. Therefore, if the record read by the latest `READ` statement does not fill the entire record area, the area not overlaid by the incoming record remains unchanged.

The record format type that was specified when the file was created must be used for all subsequent accesses to the file.

In Example 6–1, a file contains a company’s stock inventory information (part number, supplier, quantity, price). Within this file, the information is divided into records. All information for a single piece of stock constitutes a single record.

**Example 6–1 Sample Record Description**

```
01 PART-RECORD.  
   02 PART-NUMBER           PIC 9999.  
   02 PART-SUPPLIER        PIC X(20).  
   02 PART-QUANTITY        PIC 99999.  
   02 PART-PRICE           PIC S9(5)V99.
```

Each record in the stock file is itself divided into discrete pieces of information referred to as elementary items (02 level items). You give each elementary item a specific location in the record, give it a name, and define its size and type. The part number is an elementary item in the part record, as are supplier, quantity, and price. In this example, PART-RECORD contains four elementary items: PART-NUMBER, PART-SUPPLIER, PART-QUANTITY, and PART-PRICE.

**Fixed-Length Records**

Files with a fixed-length record format contain the same size records. The compiler generates the fixed-length format when either of the following conditions is true:

- The RECORD CONTAINS clause specifies a fixed number of characters.
- The RECORD CONTAINS clause is omitted.

The compiler does not generate fixed-length format when any of the following conditions exist:

- The file description contains a RECORD CONTAINS TO clause or a RECORD VARYING clause.
- The program specifies a print-control file by referring to the file with:
  - The ADVANCING phrase in a WRITE statement
  - An APPLY PRINT-CONTROL clause in the Environment Division
  - A LINAGE clause in the file description
  - Report Writer statements and phrases
  - ASSIGN TO PRINTER
- LINE SEQUENTIAL organization is specified.

Fixed-length record size is determined by either the largest record description or the record size specified by the RECORD CONTAINS clause, whichever is larger. Example 6–2 shows how fixed-length record size is determined.

**Example 6–2 Determining Fixed-Length Record Size**

```
FD FIXED-FILE  
   RECORD CONTAINS 100 CHARACTERS.  
01 FIXED-REC      PIC X(75).
```

For the file, FIXED-FILE, the RECORD CONTAINS clause specifies a record size larger than the record description; therefore, the record size is 100 characters.

In Example 6–2, the following warning message is generated when the file FIXED-FILE is used:

"Record contains value is greater than length of longest record."

## Processing Files and Records

### 6.1 Defining Files and Records

If the multiple record descriptions are associated with the file, the size of the largest record description is used as the size. In Example 6–3, for the file REC-FILE, the FIXED-REC2 record specifies the largest record size; therefore, the record size is 90 characters.

#### Example 6–3 Determining Fixed-Length Record Size for Files with Multiple Record Descriptions

```
FD REC-FILE
   RECORD CONTAINS 80 CHARACTERS.
01 FIXED-REC1   PIC X(75).
01 FIXED-REC2   PIC X(90).
```

When the file REC-FILE is used, the following warning message is generated:

```
"Longest record is longer than RECORD CONTAINS value -
   longest record size used."
```

#### Variable-Length Records

Files with a variable-length record format can contain records of different length. The compiler generates the variable-length attribute for a file when the file description contains a RECORD VARYING clause or a RECORD CONTAINS TO clause.

Each record is written to the file with a 32-bit integer that specifies the size of the record. This integer is not counted in the size of the record.

Examples 6–4, 6–5, and 6–6 show you the three ways you can create a variable-length record file.

In Example 6–4, the DEPENDING ON phrase sets the OUT-REC record length. The IN-TYPE data field determines the OUT-LENGTH field's contents.

#### Example 6–4 Creating Variable-Length Records with the DEPENDING ON Phrase

```
FILE SECTION.
FD INFILE.
01 IN-REC.
   03 IN-TYPE          PIC X.
   03 REST-OF-REC     PIC X(499).
FD OUTFILE
   RECORD VARYING FROM 200 TO 500 CHARACTERS
   DEPENDING ON OUT-LENGTH.
01 OUT-REC           PIC X(500).
WORKING-STORAGE SECTION.
01 OUT-LENGTH        PIC 999 COMP VALUE ZEROES.
```

Example 6–5 shows how to create variable-length records using the RECORD VARYING phrase.

**Example 6–5 Creating Variable-Length Records with the RECORD VARYING Phrase**

```
FILE SECTION.  
FD  OUTFILE  
   RECORD VARYING FROM 200 TO 500 CHARACTERS.  
01  OUT-REC-1      PIC X(200).  
01  OUT-REC-2      PIC X(500).
```

**Example 6–6 Creating Variable-Length Records and Using the OCCURS Clause with the DEPENDING ON Phrase**

```
.  
. .  
FILE SECTION.  
FD  PARTS-MASTER  
   RECORD VARYING 118 TO 163 CHARACTERS.  
01  PARTS-REC.  
   03  P-PART-NUM      PIC X(10).  
   03  P-PART-INFO     PIC X(100).  
   03  P-BIN-INDEX     PIC 999.  
   03  P-BIN-NUMBER    PIC X(5)  
       OCCURS 1 TO 10 TIMES DEPENDING ON P-BIN-INDEX.  
. . .
```

Example 6–6 creates variable-length records by using the OCCURS clause with the DEPENDING ON phrase in the record description. HP COBOL determines record length by adding the sum of the variable record's fixed portion to the size of the table described by the number of table occurrences at execution time.

In this example, the variable record's fixed portion size is 113 characters. (This is the sum of P-PART-NUM, P-PART-INFO, and P-BIN-INDEX.) If P-BIN-INDEX contains a 7 at execution time, P-BIN-NUMBER will be 35 characters long. Therefore, PARTS-REC's length will be 148 characters; the fixed portion's length is 113 characters, and the table entry's length at execution time is 35 characters.

If you describe a record with both the RECORD VARYING...DEPENDING ON phrase on data-name-1 and the OCCURS clause with the DEPENDING ON phrase on data-name-2, HP COBOL specifies record length as the value of data-name-1.

If you have multiple record-length descriptions for a file and omit either the RECORD VARYING clause or the RECORD CONTAINS TO clause, all records written to the file will have a fixed length equal to the length of the longest record described for the file, as in Example 6–7.

## Processing Files and Records

### 6.1 Defining Files and Records

#### Example 6–7 Defining Fixed-Length Records with Multiple Record Descriptions

```
.  
. .  
FD PARTS-MASTER.  
01 PARTS-REC-1 PIC X(200).  
01 PARTS-REC-2 PIC X(300).  
01 PARTS-REC-3 PIC X(400).  
01 PARTS-REC-4 PIC X(500).  
. .  
PROCEDURE DIVISION.  
. .  
100-WRITE-REC-1.  
    MOVE IN-REC TO PARTS-REC-1.  
    WRITE PARTS-REC-1.  
    GO TO ...  
200-WRITE-REC-2.  
    MOVE IN-REC TO PARTS-REC-2.  
    WRITE PARTS-REC-2.  
    GO TO ...  
. .  
.
```

Writing PARTS-REC-1, PARTS-REC-2, PARTS-REC-3 or PARTS-REC-4 produces records equal in length to the longest record, PARTS-REC-4. Note that this is not variable-length I/O.

#### 6.1.3 Print-Control Records

Print-control files contain record-advancing information with each record. These files are intended for eventual printing, but are created on disk by your HP COBOL program. The compiler generates print-control records when you use the WRITE AFTER ADVANCING, the LINAGE, or the APPLY PRINT-CONTROL clause, or if you create a Report Writer file or use ASSIGN TO PRINTER (on Tru64 UNIX systems).

On OpenVMS Alpha and OpenVMS I64, in any of the preceding cases, if you compile /NOVFC, the compiler does not generate print-control records, but generates stream files instead.

On OpenVMS, HP COBOL places explicit form-control bytes directly into the file. You must use the /NOFEED option on the DCL PRINT command to print a print-control file. ♦

##### Stream (Alpha, I64)

Stream files contain records of different length, delimited by a record terminator.

The compiler generates a stream record formatted file when you use the ORGANIZATION IS LINE SEQUENTIAL clause in the File-Control Division. This record format is useful for files created by text editors.

On OpenVMS Alpha or I64, a stream file will also be generated under certain situations if you compiled /NOVFC. See Section B.4.3 for more information. ♦



### 6.1.4 File Design

The difficulty of design is proportional to the complexity of the file organization. Before you create your sequential, relative, or indexed file applications, you should design your files based on these design considerations:

- **Record format**—For relative files (see Section 6.1.2)  
Relative files can contain either fixed-length records or variable-length records. However, the I/O system calculates a cell size equal to the maximum record size plus overhead bytes, resulting in fixed-length storage for relative files (see the Relative File Organization section in Section 6.1.1). Once created, relative records can be accessed sequentially, randomly, or dynamically.
- **Storage Medium**  
You can access sequential, relative, and indexed files on disk. Be careful to use a disk pack that is large enough to meet your current and future needs. You can also access sequential files, unlike relative and indexed files, on magnetic tape and unit record devices (for example, on printers).
- **Allocation** (see Chapter 15)  
On OpenVMS, you can optimize data storage at the time of file creation and file extension. ♦
- **Bucket size**—For relative files (see the Relative File Organization section in Section 6.1.1)  
You can optimize the packing of cells into buckets by ensuring that the cell size is evenly divisible into the bucket size.
- **Maximum number of records**—For relative files (see the Relative File Organization section in Section 6.1.1)
- **Key scheme**—For relative files (see the Relative File Organization section in Section 6.1.1)
- **Speed**—For indexed files (see the Indexed File Organization section in Section 6.1.1)  
You can maximize the speed with which the program processes data.
- **Space**—For indexed files (see the Indexed File Organization section in Section 6.1.1)  
You can minimize file size, disk space, and memory requirements to run your program.
- **Shared access**—For indexed files (see the Indexed File Organization section in Section 6.1.1)  
Consider who is going to use the data and how they will access it.
- **Ease of design**—For indexed files (see the Indexed File Organization section in Section 6.1.1)  
You can minimize the amount of time spent writing the application.
- **Compiler limitations** (see Appendix A)  
Consider the logical and physical limits imposed by the HP COBOL compiler.

## Processing Files and Records

### 6.1 Defining Files and Records

On OpenVMS, for more information about file design, see Chapter 15. For OpenVMS Alpha and OpenVMS I64 systems you can also refer to the *Guide to OpenVMS File Applications*. ♦ Chapter 15 contains instructions on optimizing the file design for indexed files. With indexed files, in particular, if you accept all the file defaults instead of carefully designing your file, your application may run more slowly than you expect.

## 6.2 Identifying Files and Records from Within Your HP COBOL Program

Before your program can perform I/O on a file, your program must identify the file to the operating system and specify the file's organization and access modes. A program must follow these steps whenever creating a new file or processing an existing file.

You use a file description entry to define a file's logical structure and associate the file with a file name that is unique within the program. The program uses this file name in the following COBOL statements:

- OPEN
- READ
- START
- UNLOCK
- DELETE
- CLOSE

The program uses the record name for the WRITE and REWRITE statements.

### 6.2.1 Defining a File Connector

You must establish a link between the file connector your program uses and the file specification that the I/O system uses. You create this link and define a file connector by using the SELECT statement with the ASSIGN clause and optionally specifying the VALUE OF ID clause or by using logical names or environment variables.

A **file connector** is an HP COBOL data structure that contains information about a file. The file connector links a file name and its associated record area to a physical file.

#### Defining a File Connector with SELECT and ASSIGN

Your program must include a SELECT statement, including an ASSIGN clause, for every file description entry (FD) it contains. The file name you specify in the SELECT statement must match the file name in the file description entry.

In the ASSIGN clause, you specify a nonnumeric literal or data name that associates the file name with a file specification. This value must be a complete file specification.

Example 6–8 and Example 6–9 show the relationships between the SELECT statement, the ASSIGN clause, and the FD entry.

In Example 6–8, because the file name specified in the FD entry is DAT-FILE, all I/O statements in the program referring to that file or to its associated record must use the file name DAT-FILE or the record name DAT-RECORD. The I/O system uses the ASSIGN clause to interpret DAT-FILE as REPORT.DAT on OpenVMS systems, and REPORT on Tru64 UNIX systems. The default directory

## 6.2 Identifying Files and Records from Within Your HP COBOL Program

is used on OpenVMS systems, and the current working directory is used on Tru64 UNIX systems.

### Example 6–8 Defining a Disk File

```

ENVIRONMENT DIVISION.
INPUT-OUTPUT SECTION.
FILE-CONTROL.
    SELECT DAT-FILE
        ASSIGN TO "REPORT".
    .
    .
    .
DATA DIVISION.
FILE SECTION.
FD  DAT-FILE.
01  DAT-RECORD PIC X(100).
    .
    .
    .

```

---

#### Note

---

On OpenVMS systems, if no file type is supplied, HP COBOL supplies the default file extension DAT. On Tru64 UNIX systems, the extensions dat and idx are appended, but only in the case of indexed files.

---

The I/O statements in Example 6–9 refer to MYFILE-PRO, which the ASSIGN clause identifies to the operating system as MARCH.311. Additionally, the operating system looks for the file in the current directory on the magnetic tape mounted on MTA0: on an OpenVMS system.

## Processing Files and Records

### 6.2 Identifying Files and Records from Within Your HP COBOL Program

#### Example 6–9 Defining a Magnetic Tape File (OpenVMS)

```
ENVIRONMENT DIVISION.  
INPUT-OUTPUT SECTION.  
FILE-CONTROL.  
    SELECT MYFILE-PRO  
        ASSIGN TO "MTA0:MARCH.311"  
        .  
        .  
DATA DIVISION.  
FILE SECTION.  
FD MYFILE-PRO.  
01 DAT-RECORD PIC X(100).  
    .  
    .  
PROCEDURE DIVISION.  
A000-BEGIN.  
    OPEN INPUT MYFILE-PRO.  
    .  
    .  
    READ MYFILE-PRO AT END DISPLAY "end".  
    .  
    .  
CLOSE MYFILE-PRO.  ◆
```

Example 6–10 achieves the same result as Example 6–9, but on Tru64 UNIX. The I/O statements in Example 6–10 refer to MYFILE-PRO, which the ASSIGN clause identifies to the operating system as a magnetic tape file. The file is named in the Data Division VALUE OF ID clause as MARCH.311.

#### Example 6–10 Defining a Magnetic Tape File (Tru64 UNIX)

```
ENVIRONMENT DIVISION  
INPUT-OUTPUT SECTION.  
FILE-CONTROL.  
    SELECT MYFILE-PRO  
        ASSIGN TO REEL.  
    .  
    .  
DATA DIVISION.  
FILE SECTION.  
FD MYFILE-PRO VALUE OF ID "MARCH.311".  
01 DAT-RECORD PIC X(100).  
    .  
    .  
PROCEDURE DIVISION.
```

(continued on next page)

## Processing Files and Records

### 6.2 Identifying Files and Records from Within Your HP COBOL Program

#### Example 6–10 (Cont.) Defining a Magnetic Tape File (Tru64 UNIX)

```
A000-BEGIN.  
  OPEN INPUT MYFILE-PRO.  
  .  
  .  
  .  
  READ MYFILE-PRO AT END DISPLAY "end".  
  .  
  .  
  .  
  CLOSE MYFILE-PRO.
```

For each OPEN verb referring to a file assigned to magnetic tape, the user is prompted to assign the file to a magnetic tape device. These device names are in the form /dev/rmt0(a,l,m,h) . . . /dev/rmt31(a,l,m,h) and correspond to special files on the system that refer to mass storage tape devices. For more information on tape devices, refer to the mtio(7) Tru64 UNIX manual page.

As an alternative to prompting, each file assigned to a magnetic tape can have its associated tape device defined through a shell environment variable. The name of this environment variable is the concatenation of COBOL\_TAPE\_ and the base of the file name used in the COBOL program. The value of this environment variable is the name of the desired tape device. The environment variable needed in Example 6–10 to assign the MARCH.311 file to tape device /dev/rmt0a is:

```
% setenv COBOL_TAPE_MARCH /dev/rmt0a    ◆
```

#### Establishing File Names with ASSIGN and VALUE OF ID

If the file specification is subject to change, you can use a partial file specification in the ASSIGN clause and complete it by using the optional VALUE OF ID clause of the FD entry. In the VALUE OF ID clause, you can specify a nonnumeric literal or an alphanumeric WORKING-STORAGE item to supplement the file specification.

VALUE OF ID can complete a file name specified in ASSIGN TO:

```
ASSIGN TO "filename"  
VALUE OF ID ".ext"
```

In the above example, OPEN would create a file with the name “filename.ext”.

VALUE OF ID can override a file name specified in ASSIGN TO:

```
ASSIGN TO "oldname"  
VALUE OF "newname"
```

In the above example, OPEN would create a file with the name “newname”.

VALUE OF ID can be a directory/device specification and ASSIGN TO can provide the file name, as in the following example:

```
ASSIGN TO "filename.dat"  
VALUE OF ID "/usr/"
```

or

```
ASSIGN TO "filename"  
VALUE OF ID "DISK:[DIRECTORY]"
```

On OpenVMS, with this code OPEN would create a file with the name DISK:[DIRECTORY]FILENAME.DAT. ◆

## Processing Files and Records

### 6.2 Identifying Files and Records from Within Your HP COBOL Program

On Tru64 UNIX, with this code OPEN would create a file with the name "/usr/filename.dat". ♦

#### Establishing Device and File Independence with Logical Names on OpenVMS

On OpenVMS, logical names let you write programs that are device and file independent and provide a brief way to refer to frequently used files.

You can assign logical names with the ASSIGN command. When you assign a logical name, the logical name and its equivalence name (the name of the actual file or device) are placed in one of three logical name tables; the choice depends on whether they are assigned for the current process, on the group level, or on a systemwide basis. Refer to the *OpenVMS DCL Dictionary* for more information on DCL and a description of logical name tables.

To translate a logical name, the system searches the three tables in this order: (1) process, (2) group, (3) system. Therefore, you can override a systemwide logical name by defining it for your group or process.

Logical name translation is a recursive procedure: when the system translates a logical name, it uses the equivalence name as the argument for another logical name translation. It continues in this way until it cannot translate the equivalence name.

Assume that your program updates monthly sales files (for example, JAN.DAT, FEB.DAT, MAR.DAT, and so forth). Your SELECT statement could look like either of these:

```
SELECT SALES-FILE ASSIGN TO "MOSLS"  
SELECT SALES-FILE ASSIGN TO MOSLS
```

To update the January sales file, you can use this ASSIGN command to equate the equivalence name JAN.DAT with the logical name MOSLS:

```
$ ASSIGN JAN.DAT MOSLS
```

To update the February sales file, you can use this ASSIGN command:

```
$ ASSIGN FEB.DAT MOSLS
```

In the same way, all programs that access the monthly sales file can use the logical name MOSLS.

To disassociate the relationship between the file and the logical name, you can use this DEASSIGN command:

```
$ DEASSIGN MOSLS
```

If MOSLS is not set as a logical name, the system uses it as a file specification and looks for a file named MOSLS.DAT. ♦

#### Using Environment Variables for File Specification on Tru64 UNIX

On Tru64 UNIX, environment variables can be used as aliases for file specification at run time. File name resolution follows these rules:

- Use contents of the ASSIGN TO clause or VALUE OF ID clause to find a match against an environment variable.
- If a match is found, substitute the value of the environment variable in the construction of the file specification.
- If a match was not found, take the file name as specified.

## 6.2 Identifying Files and Records from Within Your HP COBOL Program

On Tru64 UNIX, you can also use the literal or alphanumeric item to specify a run-time environment variable set. Refer to `setenv(3)` in the reference page. ♦

The program in Example 6–11 and the commands that follow it illustrate how to use the ASSIGN TO clause in conjunction with an environment variable or logical name.

### Example 6–11 Using Environment Variables (Tru64 UNIX) or Logical Names (OpenVMS) for File Specification

```
IDENTIFICATION DIVISION.
PROGRAM-ID. ENVVAR-EXAMPLE.
ENVIRONMENT DIVISION.
INPUT-OUTPUT SECTION.
FILE-CONTROL.
    SELECT F-DISK ASSIGN TO "MYENV".
DATA DIVISION.
FILE SECTION.
FD F-DISK.
01 DAT-RECORD PIC X(100).

PROCEDURE DIVISION.
P0. OPEN OUTPUT F-DISK.
    CLOSE F-DISK.

PE. STOP RUN.
END PROGRAM ENVVAR-EXAMPLE.
```

On Tru64 UNIX, set an environment variable as follows:

```
% cobol -o envtest envvar-example.cob
% setenv MYENV hello.dat
% envtest
% ls *.dat
hello.dat
% unsetenv MYENV
% envtest
% ls MY*
MYENV ♦
```

Setting environment variables at run time can help in moving applications between OpenVMS Alpha or OpenVMS I64 and Tru64 UNIX platforms without having to modify their source COBOL programs. You can define environment variables that access files in a way similar to that in which you access files using logical names on OpenVMS systems. Thus, in Example 6–11, the program is applicable to either Tru64 UNIX or to OpenVMS, because MYENV can refer to an environment variable or to a logical name.

Example 6–12 is another program that can be used on either system, depending on the definition at system level of an environment variable or logical name, as appropriate.

## Processing Files and Records

### 6.2 Identifying Files and Records from Within Your HP COBOL Program

#### Example 6–12 Using Environment Variables

```
IDENTIFICATION DIVISION.  
PROGRAM-ID. ENVVAR-EXAMPLE2.  
ENVIRONMENT DIVISION.  
INPUT-OUTPUT SECTION.  
FILE-CONTROL.  
    SELECT F-DISK ASSIGN TO "SYS$SCRATCH:envtest.dat".  
DATA DIVISION.  
FILE SECTION.  
FD F-DISK  
    VALUE OF ID "SYS$DISK:".  
01 DAT-RECORD PIC X(100).  
PROCEDURE DIVISION.  
P0. OPEN OUTPUT F-DISK.  
    CLOSE F-DISK.  
PE. STOP RUN.  
END PROGRAM ENVVAR-EXAMPLE2.
```

Example 6–12, on OpenVMS, would produce a file with the name “ENVTEST.DAT”. On Tru64 UNIX, “SYS\$SCRATCH:” has no meaning because it is a OpenVMS logical. OpenVMS logicals are not defined on Tru64 UNIX. However, the “SYS\$SCRATCH:” in the ASSIGN clause can be defined as an environment variable with the following command:

```
% setenv 'SYS$SCRATCH:' ./
```

This would make “SYS\$SCRATCH” point to the home directory. This can be used for any OpenVMS logicals used in the HP COBOL source. When you declare an environment variable you should be careful to match the case of what is in the HP COBOL source with the setenv(3) line. ♦

#### 6.2.2 Specifying File Organization and Record Access Mode

Your program must state—either explicitly or implicitly—a file’s organization and record access mode before the program opens the file. The Environment Division ORGANIZATION and ACCESS MODE clauses, if present, specify these two characteristics.

In an HP COBOL program, each file is given a file name in a separate Environment Division SELECT statement. The compiler determines the file organization from the SELECT statement and its associated clauses.

For relative and indexed files, you must specify the ORGANIZATION IS RELATIVE or the ORGANIZATION IS INDEXED phrase, respectively. For sequential files you need not specify the ORGANIZATION IS SEQUENTIAL phrase. For line sequential files (Alpha, I64), you must explicitly declare ORGANIZATION IS LINE SEQUENTIAL. When you omit the ORGANIZATION IS clause the file organization is sequential.

The ASSIGN clause, in the SELECT statement, associates the file name with a file specification. The file specification points the operating system to the file’s physical and logical location on a specific hardware device.

The SELECT statement and the ASSIGN clause are further described in Section 6.2.1. For further information, refer to the *HP COBOL Reference Manual*.

Each file is further described with a file description (FD) entry in the Data Division File Section. The FD entry is followed immediately by the file’s record description.



## Processing Files and Records

### 6.2 Identifying Files and Records from Within Your HP COBOL Program

You can specify additional file characteristics in the Environment and Data Divisions as follows:

- Use the Environment Division APPLY clause to specify file characteristics such as lock-holding, file extension factors, and preallocation factors. (See Chapter 15.)
- Use file description entries to specify record format and record blocking.
- Use record description entries to specify physical record size or sizes.

Examples 6–13, 6–14, and Example 6–15 illustrate how to specify the file organization and access mode for sequential, relative, and indexed files.

#### Example 6–13 Specifying Sequential File Organization and Sequential Access Mode for a Sequential File

```
IDENTIFICATION DIVISION.
PROGRAM-ID. SEQ01.
ENVIRONMENT DIVISION.
INPUT-OUTPUT SECTION.
FILE-CONTROL.
    SELECT MASTER-FILE ASSIGN TO "MASTER.DAT".
    SELECT TRANS-FILE ASSIGN TO "TRANS.DAT".
    SELECT REPRT-FILE ASSIGN TO "REPORT.DAT".
DATA DIVISION.
FILE SECTION.
FD MASTER-FILE.
01 MASTER-RECORD.
    02 MASTER-DATA PIC X(80).
    02 MASTER-SIZE PIC 99.
    02 MASTER-TABLE OCCURS 0 to 50 TIMES
        DEPENDING ON MASTER-SIZE.
        03 MASTER-YEAR PIC 99.
        03 MASTER-COUNT PIC S9(5)V99.
FD TRANS-FILE.
01 TRANSACTION-RECORD PIC X(25).
FD REPRT-FILE.
01 REPORT-LINE PIC X(132).
```

## Processing Files and Records

### 6.2 Identifying Files and Records from Within Your HP COBOL Program

#### Example 6–14 Specifying Relative File Organization and Random Access Mode for a Relative File

```
IDENTIFICATION DIVISION.
PROGRAM-ID. REL01.
ENVIRONMENT DIVISION.
INPUT-OUTPUT SECTION.
FILE-CONTROL.
    SELECT FLAVORS ASSIGN TO "BRAND"
        ORGANIZATION IS RELATIVE
        ACCESS MODE IS RANDOM
        RELATIVE KEY IS KETCHUP-MASTER-KEY.

DATA DIVISION.
FILE SECTION.
FD FLAVORS.
01 KETCHUP-MASTER          PIC X(50).
WORKING-STORAGE SECTION.
01 KETCHUP-MASTER-KEY     PIC 99.
```

Example 6–15 defines a dynamic access mode indexed file with one primary key and two alternate record keys. Note that one alternate record key allows duplicates. Any program using the identical entries in the SELECT clause as shown in Example 6–15 can reference the DAIRY file sequentially and randomly. Refer to the *HP COBOL Reference Manual* for information relating to the RECORD KEY and ALTERNATE RECORD KEY clauses.

#### Example 6–15 Specifying Indexed File Organization and Dynamic Access Mode for an Indexed File

```
IDENTIFICATION DIVISION.
PROGRAM-ID. INDEX01.
ENVIRONMENT DIVISION.
INPUT-OUTPUT SECTION.
FILE-CONTROL.
    SELECT FLAVORS ASSIGN TO "DAIRY"
        ORGANIZATION IS INDEXED
        ACCESS MODE IS DYNAMIC
        RECORD KEY IS ICE-CREAM-MASTER-KEY
        ALTERNATE RECORD KEY IS ICE-CREAM-STORE-STATE
            WITH DUPLICATES
        ALTERNATE RECORD KEY IS ICE-CREAM-STORE-CODE.

DATA DIVISION.
FILE SECTION.
FD FLAVORS.
01 ICE-CREAM-MASTER.
    02 ICE-CREAM-MASTER-KEY          PIC XXXX.
    02 ICE-CREAM-MASTER-DATA.
        03 ICE-CREAM-STORE-CODE     PIC XXXXX.
        03 ICE-CREAM-STORE-ADDRESS  PIC X(20).
        03 ICE-CREAM-STORE-CITY     PIC X(20).
        03 ICE-CREAM-STORE-STATE    PIC XX.

PROCEDURE DIVISION.
A00-BEGIN.
.
.
.
```

Example 6–16 defines a line sequential (Alpha, I64) file.

## 6.2 Identifying Files and Records from Within Your HP COBOL Program

**Example 6–16 Specifying Line Sequential File Organization with Sequential Access Mode (Alpha, I64)**

```

IDENTIFICATION DIVISION.
PROGRAM ID. EX0616.
ENVIRONMENT DIVISION.
INOUT-OUTPUT SECTION.
FILE-CONTROL.
    SELECT MUSIC ASSIGN TO "CLASSICAL"
        ORGANIZATION IS LINE SEQUENTIAL.
DATA DIVISION.
FILE SECTION.
FD MUSIC.
01 OPERA          PIC X(9).
PROCEDURE DIVISION.
A00-BEGIN.      ◆
.
.
.

```

File organization is discussed in more detail in Section 6.1.1. Record access mode is discussed in the following section.

**Record Access Mode**

The methods for retrieving and storing records in a file are called **record access modes**. HP COBOL supports the following three types of record access modes:

- ACCESS MODE IS SEQUENTIAL
  - With sequential files, sequential access mode retrieves the records in the same sequence established by the WRITE statements that created the file.
  - With relative files, sequential access mode retrieves the records in the order of ascending record key values (or relative record numbers).
  - With indexed files, sequential access mode retrieves records in the order of record key values.
- ACCESS MODE IS RANDOM—The value of the record key your program specifies indicates the record to be accessed in Indexed and Relative files.
- ACCESS MODE IS DYNAMIC—With relative and indexed files, dynamic access mode allows you to switch back and forth between sequential access mode and random access mode while reading a file by using the the NEXT phrase on the READ statement. For more information about dynamic access mode, refer to READ and REWRITE statements in the *HP COBOL Reference Manual*.

When you omit the ACCESS MODE IS clause in the SELECT statement, the access mode is sequential.

Example 6–17 shows sample SELECT statements for sequential files with sequential access modes.

Sample SELECT statements for relative files with sequential and dynamic access modes are shown in Example 6–18.

## Processing Files and Records

### 6.2 Identifying Files and Records from Within Your HP COBOL Program

#### Example 6–17 SELECT Statements for Sequential Files with Sequential Access Mode

```
(1)
FILE-CONTROL.
  SELECT LIST-FILE
    ASSIGN TO "MAIL.LIS"
    ORGANIZATION IS SEQUENTIAL
    ACCESS IS SEQUENTIAL.

(2)
FILE-CONTROL.
  SELECT PAYROLL
    ASSIGN TO "PAYROL.DAT".
```

#### Example 6–18 SELECT Statements for Relative Files with Sequential and Dynamic Access Modes

```
(1)
FILE-CONTROL.
  SELECT MODEL
    ASSIGN TO "ACTOR.DAT"
    ORGANIZATION IS RELATIVE
    ACCESS MODE IS SEQUENTIAL.

(2)
FILE-CONTROL.
  SELECT PARTS
    ASSIGN TO "PART.DAT"
    ORGANIZATION IS RELATIVE
    ACCESS MODE IS DYNAMIC
    RELATIVE KEY IS PART-NO.
```

#### Example 6–19 SELECT Statements for Indexed Files with Dynamic and Default Sequential Access Modes

```
(1)
FILE-CONTROL.
  SELECT A-GROUP
    ASSIGN TO "RFCBA.PRO"
    ORGANIZATION IS INDEXED
    ACCESS MODE IS DYNAMIC
    RECORD KEY IS WRITER
    ALTERNATE RECORD KEY IS EDITOR.

(2)
FILE-CONTROL.
  SELECT TEAS
    ASSIGN TO "TEA"
    ORGANIZATION IS INDEXED
    RECORD KEY IS LEAVES.
```

#### Example 6–20 SELECT Statements for Line Sequential Files with Sequential Access Modes (Alpha, I64)

```
(1)
FILE-CONTROL.
  SELECT MAMMALS
    ASSIGN TO "DOLPHINS"
    ORGANIZATION IS LINE SEQUENTIAL
    ACCESS MODE IS SEQUENTIAL.

(2)
FILE-CONTROL.
  SELECT VACATION-SPOTS
    ASSIGN TO "BAHAMAS"
    ORGANIZATION IS LINE SEQUENTIAL.
```

Sample SELECT statements for indexed files with dynamic and sequential access modes are shown in Example 6–19.

Because the default file organization is also sequential, both the relative and indexed examples require the ORGANIZATION IS clause.

Sample SELECT statements for line sequential files with sequential access modes are shown in Example 6–20.

## 6.3 Creating and Processing Files

Creating and processing sequential, line sequential, relative, and indexed files includes the following tasks:

1. Opening the file
2. Executing valid I/O statements
3. Closing the file

Sections 6.3.2, 6.3.3, and 6.3.4 describe the specific tasks involved in creating and processing sequential, relative, and indexed files.

### 6.3.1 Opening and Closing Files

An HP COBOL program must open a file with an OPEN statement before any other I/O or Report Writer statement can reference it. Files can be opened more than once in the same program as long as they are closed before being reopened.

Sample OPEN and CLOSE statements are shown in Example 6–21.

#### Example 6–21 OPEN and CLOSE Statements

```
.  
. .  
OPEN INPUT MASTER-FILE.  
OPEN OUTPUT REPORT-FILE.  
OPEN I-O MASTER-FILE2  
      TRANS-FILE  
      OUTPUT REPORT-FILE2.  
CLOSE MASTER-FILE.  
CLOSE TRANS-FILE, MASTER-FILE2  
      REPORT-FILE, REPORT-FILE2.  
. . .
```

The OPEN statement must specify one of the following four open modes:

```
INPUT  
OUTPUT  
I-O {Not for LINE SEQUENTIAL}  
EXTEND
```

Your choice, along with the file's organization and access mode, determines which I/O statements you can use. Sections 6.3.2, 6.3.3, and 6.3.4 discuss the I/O statements for sequential, relative, and indexed files, respectively. Section 12.8.4, Case Sensitivity on Tru64 UNIX explains the importance of attention to case.

When your program performs an OPEN statement, the following events take place:

1. The I/O system builds a file specification by using the contents of the VALUE OF ID clause, if any, to alter or complete the file specification in the ASSIGN clause. Logicals and environment variables are translated.
2. The I/O system checks the file's current status. If the file is unavailable, or if it was closed WITH LOCK, the OPEN statement fails. (See Chapter 8 for information on file sharing.)

## Processing Files and Records

### 6.3 Creating and Processing Files

3. If the file specification names an invalid device, or contains any other errors, the I/O system generates an error message and the OPEN statement fails.
4. The I/O system takes one of the following actions if it cannot find the file:
  - a. If the file's OPEN mode is OUTPUT, the file is created.
  - b. If the file's OPEN mode is EXTEND, or I-O, the OPEN statement fails, unless the file's SELECT clause includes the OPTIONAL phrase. If the file's SELECT clause includes the OPTIONAL phrase, the file is created.
  - c. If the file's OPEN mode is INPUT, and its SELECT clause includes the OPTIONAL phrase, the OPEN statement is successful. The first read on that file causes the AT END or INVALID KEY condition.
  - d. If none of the previous conditions is met, the OPEN fails and the Declarative USE procedure (if any) gains control. If no Declarative USE procedure exists, the I/O system aborts the program.
5. If the file's OPEN mode is OUTPUT, and a file by the same name already exists, a new version is created.
6. If the file characteristics specified by the program attempting an OPEN operation differ from the characteristics specified when the file was created, the OPEN statement fails.

If the file is on magnetic tape, the I/O system rewinds the tape. (To close a file on tape without rewinding the tape, use the NO REWIND phrase.) This speeds processing when you want to write another file beyond the end of the first file, as in the following example:

```
CLOSE MASTER-FILE NO REWIND.
```

You can also close a file and prevent your program from opening that file again in the same run, as in the following example:

```
CLOSE MASTER-FILE WITH LOCK.
```

#### 6.3.2 File Handling for Sequential and Line Sequential (Alpha, I64) Files

Creating a sequential or (on Alpha and I64 only) line sequential file involves the following:

1. Opening the file for OUTPUT or EXTEND
2. Executing valid I/O statements
3. Closing the file

By default, HP COBOL assumes sequential organization and sequential access mode. (See Example 6-22.)

##### Example 6-22 Creating a Sequential File

```
IDENTIFICATION DIVISION.  
PROGRAM-ID. SEQ01.  
ENVIRONMENT DIVISION.  
INPUT-OUTPUT SECTION.  
FILE-CONTROL.  
    SELECT TRANS-FILE ASSIGN TO "TRANS.DAT".
```

(continued on next page)

**Example 6–22 (Cont.) Creating a Sequential File**

```
DATA DIVISION.  
FILE SECTION.  
FD TRANS-FILE.  
01 TRANSACTION-RECORD    PIC X(25).  
PROCEDURE DIVISION.  
A000-BEGIN.  
    OPEN OUTPUT TRANS-FILE.  
    PERFORM A010-PROCESS-TRANS  
        UNTIL TRANSACTION-RECORD = "END".  
    CLOSE TRANS-FILE.  
    STOP RUN.  
A010-PROCESS-TRANS.  
    DISPLAY "Enter next record - X(25)".  
    DISPLAY "enter END to terminate the session".  
    DISPLAY "-----".  
    ACCEPT TRANSACTION-RECORD.  
    IF TRANSACTION-RECORD NOT = "END"  
        WRITE TRANSACTION-RECORD.
```

**Example 6–23 Creating a Line Sequential File (Alpha, I64)**

```
IDENTIFICATION DIVISION.  
PROGRAM-ID. LINESEQ01.  
ENVIRONMENT DIVISION.  
INPUT-OUTPUT SECTION.  
FILE-CONTROL.  
    SELECT LINESEQ-FILE ASSIGN TO "LINESEQ.DAT".  
DATA DIVISION.  
FILE SECTION.  
FD LINESEQ-FILE.  
01 LINESEQ-RECORD    PIC X(25).  
PROCEDURE DIVISION.  
A000-BEGIN.  
    OPEN OUTPUT LINESEQ-FILE.  
    CLOSE LINESEQ-FILE.  
    STOP RUN.
```

By default, HP COBOL assumes sequential access mode when the line sequential organization is specified. (See Example 6–23.) ♦

**Statements for Sequential and Line Sequential (Alpha, I64) File Processing**

Processing a sequential file or line sequential file (Alpha, I64) involves the following:

1. Opening the file
2. Processing the file with valid I/O statements
3. Closing the file

Table 6–3 lists the valid I/O statements for sequential files, and Table 6–4 lists the valid I/O statements for line sequential files. Both tables illustrate the following relationships:

- Organization determines valid access modes.
- Organization and access mode determine valid open modes.

## Processing Files and Records

### 6.3 Creating and Processing Files

- All three (organization, access, and open mode) enable or disable I/O statements.

**Table 6–3 Valid I/O Statements for Sequential Files**

File Organization	Access Mode	Statement	Open Mode			
			INPUT	OUTPUT I/O	EXTEND	
SEQUENTIAL	SEQUENTIAL	READ	Yes	No	Yes	No
		REWRITE	No	No	Yes	No
		WRITE	No	Yes	No	Yes
		UNLOCK	Yes	Yes	Yes	Yes

#### Writing a Sequential File

Each WRITE statement appends a logical record to the end of an output file, thereby creating an entirely new record in the file. The WRITE statement appends records to files that are OPEN for the following modes:

- OUTPUT—Output mode can create the following two kinds of files:
  - Storage files—A storage file remains on tape or disk for future reference or processing.
  - Print-control files—The Data Division LINAGE clause, the Environment Division APPLY PRINT-CONTROL clause, the Procedure Division ADVANCING phrase (in the WRITE statement), or Report Writer statements and phrases designates a file as a print-control file.  
On OpenVMS Alpha and OpenVMS I64, each record in a print-control file contains a header that performs line spacing. On Tru64 UNIX, line spacing is done with blank records in print-control files.
- EXTEND—Extend mode permits new records to be added in sequence after the last record of an existing file (see Extending a Sequential File or Line Sequential File (Alpha, I64) in Section 6.5.1).

**Table 6–4 Valid I/O Statements for Line Sequential Files (Alpha, I64)**

File Organization	Access Mode	Statement	Open Mode		
			INPUT	OUTPUT	EXTEND
LINE SEQUENTIAL	SEQUENTIAL	READ	Yes	No	No
		WRITE	No	Yes	Yes
		UNLOCK	Yes	Yes	Yes



### Writing a Line Sequential File (Alpha, I64)

Each WRITE statement appends a logical record to the end of an output file, thereby creating an entirely new record in the file. The WRITE statement appends records to files that are OPEN for the following modes:

- OUTPUT—Output mode creates a new file or overwrites an already existing file.
- EXTEND—Extend mode permits new records to be added in sequence after the last record of an existing file (see Extending a Sequential File or Line Sequential File (Alpha, I64). ♦

### Writing a Record

You can write records in the following two ways:

- WRITE record-name FROM source-area
- WRITE record-name

The first way provides easier program readability with multiple record types. For example, statements (1) and (2) in the following example are logically equivalent:

```
FILE SECTION.  
FD STOCK-FILE.  
01 STOCK-RECORD      PIC X(80).  
WORKING-STORAGE SECTION.  
01 STOCK-WORK        PIC X(80).  
  
-----(1)-----          -----(2)-----  
WRITE STOCK-RECORD FROM STOCK-WORK.      MOVE STOCK-WORK TO STOCK-RECORD.  
                                           WRITE STOCK-RECORD.
```

When you omit the FROM phrase, you process the records directly in the record area or buffer (for example, STOCK-RECORD).

The following example writes the record PRINT-LINE to the device assigned to that record's file, then skips three lines. At the end of the page (as specified by the LINAGE clause), it causes program control to transfer to HEADER-ROUTINE.

```
WRITE PRINT-LINE BEFORE ADVANCING 3 LINES  
      AT END-OF-PAGE PERFORM HEADER-ROUTINE.
```

For a WRITE FROM statement, if the destination area is shorter than the file's record length, the destination area is padded on the right with spaces; if longer, the destination area is truncated on the right. This follows the rules for a group move.

### 6.3.3 File Handling for Relative Files

Creating a relative file involves the following tasks:

1. Specifying ORGANIZATION IS RELATIVE in the Environment Division SELECT clause
2. Specifying ACCESS MODE IS SEQUENTIAL (or RANDOM) in the Environment Division SELECT clause

Each of these two access modes requires a different processing technique. (Refer to the Creating a Relative File in Sequential Access Mode and Creating a Relative File in Random Access Mode sections in this chapter for information about those techniques.)

## Processing Files and Records

### 6.3 Creating and Processing Files

3. Opening the file for OUTPUT or I-O
4. Initializing the relative key data name for each new record
5. Executing a WRITE statement for each new relative record
6. Closing the file

#### Creating a Relative File in Sequential Access Mode

When your program creates a relative file in sequential access mode, the I/O system does not use the relative key. Instead, it writes the first record in the file at relative record number 1, the second record at relative record number 2, and so on, until the program closes the file. If you use the RELATIVE KEY IS clause, the compiler moves the relative record number of the record being written to the relative key data item. Example 6–24 writes 10 records with relative record numbers 1 to 10.

#### Example 6–24 Creating a Relative File in Sequential Access Mode

```
IDENTIFICATION DIVISION.
PROGRAM-ID. REL02.
ENVIRONMENT DIVISION.
INPUT-OUTPUT SECTION.
FILE-CONTROL.
    SELECT FLAVORS ASSIGN TO "BRAND"
        ORGANIZATION IS RELATIVE
        ACCESS MODE IS SEQUENTIAL.

DATA DIVISION.
FILE SECTION.
FD  FLAVORS.
01  KETCHUP-MASTER.
    02  FILLER                PIC X(14).
    02  REC-NUM                PIC 9(05).
    02  FILLER                PIC X(31).
    02  FILLER                PIC X(31).

WORKING-STORAGE SECTION.
01  REC-COUNT                PIC S9(5) VALUE 0.

PROCEDURE DIVISION.
A000-BEGIN.
    OPEN OUTPUT FLAVORS.
    PERFORM A010-WRITE 10 TIMES.
    CLOSE FLAVORS.
    STOP RUN.

A010-WRITE.
    MOVE "Record number" TO KETCHUP-MASTER.
    ADD 1 TO REC-COUNT.
    MOVE REC-COUNT TO REC-NUM.
    WRITE KETCHUP-MASTER
        INVALID KEY DISPLAY "BAD WRITE"
        STOP RUN.
```

#### Creating a Relative File in Random Access Mode

When a program creates a relative file using random access mode, the program must place a value in the RELATIVE KEY data item before executing a WRITE statement. Example 6–25 shows how to supply the relative key. It writes 10 records in the cells numbered: 2, 4, 6, 8, 10, 12, 14, 16, 18, and 20. Record cells 1, 3, 5, 7, 9, 11, 13, 15, 17, and 19 are also created, but contain no valid records.

## Processing Files and Records

### 6.3 Creating and Processing Files

#### Example 6–25 Creating a Relative File in Random Access Mode

```
IDENTIFICATION DIVISION.
PROGRAM-ID. REL03.
ENVIRONMENT DIVISION.
INPUT-OUTPUT SECTION.
FILE-CONTROL.
    SELECT FLAVORS ASSIGN TO "BRAND"
        ORGANIZATION IS RELATIVE
        ACCESS MODE IS RANDOM
        RELATIVE KEY IS KETCHUP-MASTER-KEY.

DATA DIVISION.
FILE SECTION.
FD FLAVORS.
01 KETCHUP-MASTER.
    02 FILLER          PIC X(14).
    02 REC-NUM        PIC 9(05).
    02 FILLER          PIC X(31).
WORKING-STORAGE SECTION.
01 KETCHUP-MASTER-KEY PIC 99.
01 REC-COUNT          PIC S9(5) VALUE 0.

PROCEDURE DIVISION.
A000-BEGIN.
    OPEN OUTPUT FLAVORS.
    MOVE 0 TO KETCHUP-MASTER-KEY.
    PERFORM A010-CREATE-RELATIVE-FILE 10 TIMES.
    DISPLAY "END OF JOB".
    CLOSE FLAVORS.
    STOP RUN.

A010-CREATE-RELATIVE-FILE.
    ADD 2 TO KETCHUP-MASTER-KEY.
    MOVE "Record number" TO KETCHUP-MASTER.
    ADD 2 TO REC-COUNT.
    MOVE REC-COUNT TO REC-NUM.
    WRITE KETCHUP-MASTER
        INVALID KEY DISPLAY "BAD WRITE"
        STOP RUN.
```

#### Statements for Relative File Processing

Processing a relative file involves the following:

1. Opening the file
2. Setting the relative record number
3. Processing the file with valid I/O statements
4. Closing the file

Table 6–5 lists the valid I/O statements and illustrates the following relationships:

- Organization determines valid access modes.
- Organization and access mode determine valid open modes.
- All three (organization, access, and open mode) enable or disable I/O statements.

## Processing Files and Records

### 6.3 Creating and Processing Files

Table 6–5 Valid I/O Statements for Relative Files

File Organization	Access Mode	Statement	Open Mode			
			INPUT	OUTPUT	I-O	EXTEND
RELATIVE	SEQUENTIAL	DELETE	No	No	Yes	No
		READ	Yes	No	Yes	No
		REWRITE	No	No	Yes	No
		START	Yes	No	Yes	No
		WRITE	No	Yes	No	Yes
		UNLOCK	Yes	Yes	Yes	Yes
	RANDOM	DELETE	No	No	Yes	No
		READ	Yes	No	Yes	No
		REWRITE	No	No	Yes	No
		WRITE	No	Yes	Yes	No
		UNLOCK	Yes	Yes	Yes	No
	DYNAMIC	DELETE	No	No	Yes	No
		READ	Yes	No	Yes	No
		READ NEXT	Yes	No	Yes	No
		REWRITE	No	No	Yes	No
		START	Yes	No	Yes	No
		WRITE	No	Yes	Yes	No
		UNLOCK	Yes	Yes	Yes	No

#### Writing a Relative File

Each WRITE statement places a record into a cell that contains no valid data. If the cell does not already exist, the I/O system creates it. To change the contents of a cell that already contains valid data, use the REWRITE statement.

#### 6.3.4 File Handling for Indexed Files

Creating an indexed file involves the following tasks:

1. Specifying ORGANIZATION IS INDEXED in the Environment Division SELECT clause
2. Specifying ACCESS MODE IS SEQUENTIAL (or RANDOM or DYNAMIC) in the Environment Division SELECT clause
3. Opening the file for OUTPUT (to create and add records) or for I-O (to add, change, delete, or extend records)
4. Initializing the key values
5. Executing a WRITE statement
6. Closing the file

One way to populate an indexed file is to sequentially write the records in ascending order by primary key. Example 6–26 creates and populates an indexed file from a sequential file, which has been sorted in ascending sequence on the primary key field. Notice that the primary and alternate keys are initialized in ICE-CREAM-MASTER when the contents of the fields in INPUT-RECORD are read into ICE-CREAM-MASTER before the record is written.

## Processing Files and Records

### 6.3 Creating and Processing Files

#### Example 6–26 Creating and Populating an Indexed File

```
IDENTIFICATION DIVISION.
PROGRAM-ID. INDEX02.
ENVIRONMENT DIVISION.
INPUT-OUTPUT SECTION.
FILE-CONTROL.
    SELECT INPUT-FILE ASSIGN TO "DAIRYI".
    SELECT FLAVORS      ASSIGN TO "DAIRY"
                        ORGANIZATION IS INDEXED
                        ACCESS MODE IS SEQUENTIAL
                        RECORD KEY IS ICE-CREAM-MASTER-KEY
                        ALTERNATE RECORD KEY IS ICE-CREAM-STORE-STATE
                        WITH DUPLICATES
                        ALTERNATE RECORD KEY IS ICE-CREAM-STORE-CODE.

DATA DIVISION.
FILE SECTION.
FD INPUT-FILE.
01 INPUT-RECORD.
    02 INPUT-RECORD-KEY          PIC 9999.
    02 INPUT-RECORD-DATA        PIC X(47).
FD FLAVORS.
01 ICE-CREAM-MASTER.
    02 ICE-CREAM-MASTER-KEY      PIC XXXX.
    02 ICE-CREAM-MASTER-DATA.
        03 ICE-CREAM-STORE-CODE  PIC XXXXX.
        03 ICE-CREAM-STORE-ADDRESS PIC X(20).
        03 ICE-CREAM-STORE-CITY  PIC X(20).
        03 ICE-CREAM-STORE-STATE PIC XX.

WORKING-STORAGE SECTION.
01 END-OF-FILE                  PIC X.

PROCEDURE DIVISION.
A000-BEGIN.
    OPEN INPUT INPUT-FILE.
    OPEN OUTPUT FLAVORS.
A010-POPULATE.
    PERFORM A100-READ-INPUT UNTIL END-OF-FILE = "Y".
A020-EOJ.
    DISPLAY "END OF JOB".
    STOP RUN.
A100-READ-INPUT.
    READ INPUT-FILE INTO ICE-CREAM-MASTER
      AT END MOVE "Y" TO END-OF-FILE.
    IF END-OF-FILE NOT = "Y"
      WRITE ICE-CREAM-MASTER INVALID KEY DISPLAY "BAD WRITE"
      STOP RUN.
```

The program can add records to the file until it reaches the physical limitations of its storage device. When this occurs, you should follow these steps:

1. Delete unnecessary records.
2. Back up the file.
3. Recreate the file either by using the OpenVMS Alpha and I64 CONVERT Utility to optimize file space, or by using an HP COBOL program.

#### Statements for Indexed File Processing

Processing an indexed file involves the following:

1. Opening the file
2. Processing the file with valid I/O statements
3. Closing the file

## Processing Files and Records

### 6.3 Creating and Processing Files

Table 6–6 lists the valid I/O statements and illustrates the following relationships:

- File organization determines valid access modes.
- File organization and access mode determine valid open modes.
- All three (organization, access, and open mode) enable or disable I/O statements.

**Table 6–6 Valid I/O Statements for Indexed Files**

File Organization	Access Mode	Statement	Open Mode			
			INPUT	OUTPUT	I-O	EXTEND
INDEXED	SEQUENTIAL	DELETE	No	No	Yes	No
		READ	Yes	No	Yes	No
		REWRITE	No	No	Yes	No
		START	Yes	No	Yes	No
		WRITE	No	Yes	No	Yes
		UNLOCK	Yes	Yes	Yes	Yes
	RANDOM	DELETE	No	No	Yes	No
		READ	Yes	No	Yes	No
		REWRITE	No	No	Yes	No
		WRITE	No	Yes	Yes	No
		UNLOCK	Yes	Yes	Yes	No
	DYNAMIC	DELETE	No	No	Yes	No
		READ	Yes	No	Yes	No
		READ NEXT	Yes	No	Yes	No
		REWRITE	No	No	Yes	No
		START	Yes	No	Yes	No
		WRITE	No	Yes	Yes	No
		UNLOCK	Yes	Yes	Yes	No

#### Writing an Indexed File

You specify sequential access mode in the Environment Division SELECT clause when you want to write records in ascending or descending order by primary key, depending on the sort order. Specify random or dynamic access mode to enable your program to write records in any order.

#### Using Segmented Keys in Indexed Files

Segmented keys are a form of primary or alternate keys. A segmented key can be made up of multiple pieces, or segments. These segments are data items that you define in the record description entry for a file. They are concatenated, in order of specification in the ALTERNATE RECORD KEY or RECORD KEY clause, to form the segmented key, which will be treated like any "simple" primary or alternate key.

With segmented keys, you have more flexibility in defining record description entries for indexed files. A segmented key is made up of between one and eight data items, which can be defined anywhere and in any order within the record description, and which can even overlap. For example, you might use the following record definition in your program:

## Processing Files and Records

### 6.3 Creating and Processing Files

```
01 EMPLOYEE.  
   02 FORENAME    PIC X(10).  
   02 BADGE-NO    PIC X(6).  
   02 DEPT        PIC X(2).  
   02 SURNAME     PIC X(20).  
   02 INITIAL     PIC X(1).
```

Then the following line in your program, which specifies the segmented key *name* and three of its segments:

```
RECORD KEY IS NAME = SURNAME FORENAME INITIAL
```

causes HP COBOL to treat *name* as if it were an explicitly defined group item consisting of the following:

```
02 SURNAME    PIC X(20).  
02 FORENAME   PIC X(10).  
02 INITIAL    PIC X(1).
```

You define a segmented key in either the RECORD KEY clause or the ALTERNATE RECORD KEY clause. You use the START or READ statement to reference a segmented key.

Each segment is a data-name of a data item in a record description entry. A segment can be an alphanumeric or alphabetic item, a group item, or an unsigned numeric display item. A segment can be qualified, but it cannot be a group item containing a variable-occurrence item.

Refer to the chapters on the Data Division and the Procedure Division in the *HP COBOL Reference Manual* for more information on segmented keys.

Example 6–27 shows how you might use segmented keys. In this example, SEG-ICE-CREAM-KEY is a segmented-key name. ICE-CREAM-STORE-KIND and ICE-CREAM-STORE-ZIP are the segments. Notice that the segmented-key name is referenced in the READ statement.

#### Example 6–27 Using Segmented Keys

```
IDENTIFICATION DIVISION.  
PROGRAM-ID.  MANAGER.  
ENVIRONMENT DIVISION.  
INPUT-OUTPUT SECTION.  
FILE-CONTROL.  
    SELECT FLAVORS    ASSIGN TO "STORE"  
        ORGANIZATION IS INDEXED  
        ACCESS MODE IS RANDOM  
        RECORD KEY IS  
SEG-ICE-CREAM-KEY =  
    ICE-CREAM-STORE-KIND,  
    ICE-CREAM-STORE-ZIP.
```

(continued on next page)

## Processing Files and Records

### 6.3 Creating and Processing Files

#### Example 6–27 (Cont.) Using Segmented Keys

```
DATA DIVISION.
FILE SECTION.
FD FLAVORS.
01 ICE-CREAM-MASTER.
   02 ICE-CREAM-DATA.
       03 ICE-CREAM-STORE-KIND          PIC XX.
       03 ICE-CREAM-STORE-MANAGER      PIC X(40).
       03 ICE-CREAM-STORE-SIZE         PIC XX.
       03 ICE-CREAM-STORE-ADDRESS      PIC X(20).
       03 ICE-CREAM-STORE-CITY         PIC X(20).
       03 ICE-CREAM-STORE-STATE        PIC XX.
       03 ICE-CREAM-STORE-ZIP          PIC XXXXX.
WORKING-STORAGE SECTION.
01 PROGRAM-STAT                        PIC X.
   88 OPERATOR-STOPS-IT                 VALUE "1".
PROCEDURE DIVISION.
A000-BEGIN.
   OPEN I-O FLAVORS.
   PERFORM A020-INITIAL-PROMPT.
   IF OPERATOR-STOPS-IT
       PERFORM A005-TERMINATE.
   PERFORM A030-RANDOM-READ.
   PERFORM A025-SUBSEQUENT-PROMPTS UNTIL OPERATOR-STOPS-IT.
   PERFORM A005-TERMINATE.
A005-TERMINATE.
   DISPLAY "END OF JOB".
   STOP RUN.
A020-INITIAL-PROMPT.
   DISPLAY "Do you want to see the manager of a store?".
   PERFORM A040-GET-ANS UNTIL PROGRAM-STAT = "Y" OR "y" OR "N" OR "n".
   IF PROGRAM-STAT = "N" OR "n"
       THEN
           MOVE "1" TO PROGRAM-STAT.
A025-SUBSEQUENT-PROMPTS.
   MOVE SPACE TO PROGRAM-STAT.
   DISPLAY "Do you want to see the manager of another store?".
   PERFORM A040-GET-ANS UNTIL PROGRAM-STAT = "Y" OR "y" OR "N" OR "n".
   IF PROGRAM-STAT = "Y" OR "y"
       THEN
           PERFORM A030-RANDOM-READ
       ELSE
           MOVE "1" TO PROGRAM-STAT.
A030-RANDOM-READ.
   DISPLAY "Enter store kind: ".
   ACCEPT ICE-CREAM-STORE-KIND.
   DISPLAY "Enter zip code: " AT LINE PLUS 2.
   ACCEPT ICE-CREAM-STORE-ZIP.
   PERFORM A100-READ-INPUT-BY-KEY.
A040-GET-ANS.
   DISPLAY "Please answer Y or N"
   ACCEPT PROGRAM-STAT.
A100-READ-INPUT-BY-KEY.
   READ FLAVORS KEY IS SEG-ICE-CREAM-KEY
   INVALID KEY
       DISPLAY "Store does not exist - Try again"
   NOT INVALID KEY
       DISPLAY "The manager is: ", ICE-CREAM-STORE-MANAGER.
```



## 6.4 Reading Files

Reading sequential, line sequential, relative, and indexed files includes the following tasks:

1. Opening the file
2. Executing a READ or START statement

Sections 6.4.1, 6.4.2, and 6.4.3 describe the specific tasks involved in reading sequential, line sequential, relative, and indexed files.

### 6.4.1 Reading a Sequential or Line Sequential (Alpha, I64) File

Reading a sequential or (on Alpha and I64 only) line sequential file involves the following:

1. Opening the file for INPUT or I/O for sequential files, or INPUT for line sequential files (I/O is not permitted for line sequential files)
2. Executing a READ statement

Each READ statement reads a single logical record and makes its contents available to the program in the record area. There are two ways of reading records:

- READ file-name INTO destination-area
- READ file-name

Statements (1) and (2) in the following example are logically equivalent:

```
FILE SECTION.  
FD STOCK-FILE.  
01 STOCK-RECORD      PIC X(80).  
WORKING-STORAGE SECTION.  
01 STOCK-WORK        PIC X(80).  
  
----- (1) -----          ----- (2) -----  
READ STOCK-FILE INTO STOCK-WORK.  READ STOCK-FILE.  
                                  MOVE STOCK-RECORD TO STOCK-WORK.
```

When you omit the INTO phrase, you process the records directly in the record area or buffer (for example, STOCK-RECORD). The record is also available in the record area if you use the INTO phrase.

In a READ INTO clause, if the destination area is shorter than the length of the record area being read, the record is truncated on the right and a warning is issued; if longer, the destination area is filled on the right with blanks.

If the data in the record being read is shorter than the length of the record (for example, a variable-length record), the contents of the record beyond that data are undefined.

Generally speaking, if the recordtype is fixed, the prolog and epilog are zero. The exceptions to this are: for relative files there is a 1 byte record status flag prolog; for sequential files there is a 1 byte epilog if the record length is odd.

Example 6–28 reads a sequential file and displays its contents on the terminal.

## Processing Files and Records

### 6.4 Reading Files

#### Example 6–28 Reading a Sequential File

```
IDENTIFICATION DIVISION.  
PROGRAM-ID. SEQ02.  
ENVIRONMENT DIVISION.  
INPUT-OUTPUT SECTION.  
FILE-CONTROL.  
    SELECT TRANS-FILE ASSIGN TO "TRANS".  
DATA DIVISION.  
FILE SECTION.  
FD  TRANS-FILE.  
01  TRANSACTION-RECORD    PIC X(25).  
PROCEDURE DIVISION.  
A000-BEGIN.  
    OPEN INPUT TRANS-FILE.  
    PERFORM A100-READ-TRANS-FILE  
        UNTIL TRANSACTION-RECORD = "END".  
    CLOSE TRANS-FILE.  
    STOP RUN.  
A100-READ-TRANS-FILE.  
    READ TRANS-FILE  
        AT END MOVE "END" TO TRANSACTION-RECORD.  
    IF TRANSACTION-RECORD NOT = "END"  
        DISPLAY TRANSACTION-RECORD.
```

#### 6.4.2 Reading a Relative File

Your program can read a relative file sequentially, randomly, or dynamically. The following three sections describe the specific tasks involved in reading a relative file sequentially, randomly, and dynamically.

##### Reading a Relative File Sequentially

Reading relative records sequentially involves the following:

1. Specifying ORGANIZATION IS RELATIVE in the Environment Division SELECT clause
2. Specifying ACCESS MODE IS SEQUENTIAL (or DYNAMIC) in the Environment Division SELECT clause (and using the READ NEXT phrase)
3. Opening the file for INPUT or I-O
4. Reading records as you would a sequential file, or using a START statement

The READ statement makes the next logical record of an open file available to the program. The system reads the file sequentially from either cell 1 or wherever you START the file, up to cell n. It skips the empty cells and retrieves only valid records. Each READ statement updates the contents of the file's RELATIVE KEY data item, if specified. The data item contains the relative number of the available record. When the at end condition occurs, execution of the READ statement is unsuccessful (see Chapter 7).

Sequential processing need not begin at the first record of a relative file. The START statement specifies the next record to be read and positions the file position indicator for subsequent I/O operations.

Example 6–29 reads a relative file sequentially, displaying every record on the terminal.

**Example 6–29 Reading a Relative File Sequentially**

```
IDENTIFICATION DIVISION.  
PROGRAM-ID. REL04.  
ENVIRONMENT DIVISION.  
INPUT-OUTPUT SECTION.  
FILE-CONTROL.  
    SELECT FLAVORS ASSIGN TO "BRAND"  
        ORGANIZATION IS RELATIVE  
        ACCESS MODE IS SEQUENTIAL  
        RELATIVE KEY IS KETCHUP-MASTER-KEY.  
  
DATA DIVISION.  
FILE SECTION.  
FD FLAVORS.  
01 KETCHUP-MASTER          PIC X(50).  
WORKING-STORAGE SECTION.  
01 KETCHUP-MASTER-KEY     PIC 99.  
01 END-OF-FILE             PIC X.  
PROCEDURE DIVISION.  
A000-BEGIN.  
    OPEN INPUT FLAVORS.  
    PERFORM A010-DISPLAY-RECORDS UNTIL END-OF-FILE = "Y".  
A005-EOJ.  
    DISPLAY "END OF JOB".  
    CLOSE FLAVORS.  
    STOP RUN.  
A010-DISPLAY-RECORDS.  
    READ FLAVORS AT END MOVE "Y" TO END-OF-FILE.  
    IF END-OF-FILE NOT = "Y" DISPLAY KETCHUP-MASTER.
```

**Reading a Relative File Randomly**

Reading relative records randomly involves the following:

1. Specifying ORGANIZATION IS RELATIVE in the Environment Division SELECT clause
2. Specifying ACCESS MODE IS RANDOM (or DYNAMIC) in the Environment Division SELECT clause
3. Opening the file for INPUT or I-O
4. Moving the relative record number value to the RELATIVE KEY data name
5. Reading the record from the cell identified by the relative record number

The READ statement selects a specific record from an open file and makes it available to the program. The value of the relative key identifies the specific record. The system reads the record identified by the RELATIVE KEY data name clause. If the cell does not contain a valid record, the invalid key condition occurs, and the READ operation fails (see Chapter 7).

## Processing Files and Records

### 6.4 Reading Files

Example 6–30 reads a relative file randomly, displaying every record on the terminal.

#### Example 6–30 Reading a Relative File Randomly

```
IDENTIFICATION DIVISION.
PROGRAM-ID. REL05.
ENVIRONMENT DIVISION.
INPUT-OUTPUT SECTION.
FILE-CONTROL.
    SELECT FLAVORS ASSIGN TO "BRAND"
        ORGANIZATION IS RELATIVE
        ACCESS MODE IS RANDOM
        RELATIVE KEY IS KETCHUP-MASTER-KEY.

DATA DIVISION.
FILE SECTION.
FD FLAVORS.
01 KETCHUP-MASTER          PIC X(50).

WORKING-STORAGE SECTION.
01 KETCHUP-MASTER-KEY     PIC 99 VALUE 99.

PROCEDURE DIVISION.
A000-BEGIN.
    OPEN INPUT FLAVORS.
    PERFORM A100-DISPLAY-RECORD UNTIL KETCHUP-MASTER-KEY = 00.
    DISPLAY "END OF JOB".
    CLOSE FLAVORS.
    STOP RUN.

A100-DISPLAY-RECORD.
    DISPLAY "TO DISPLAY A RECORD ENTER ITS RECORD NUMBER (0 to END)".
    ACCEPT KETCHUP-MASTER-KEY WITH CONVERSION.
    IF KETCHUP-MASTER-KEY > 00
        READ FLAVORS
            INVALID KEY DISPLAY "BAD KEY"
                CLOSE FLAVORS
                STOP RUN
    END-READ
    DISPLAY KETCHUP-MASTER.
```

#### Reading a Relative File Dynamically

The READ statement has two formats so that it can select the next logical record (sequential access) or select a specific record (random access) and make it available to the program. In dynamic mode, the program can switch from random access I/O statements to sequential access I/O statements in any order, without closing and reopening files. However, you must use the READ NEXT statement to sequentially read a relative file open in dynamic mode.

Sequential processing need not begin at the first record of a relative file. The START statement repositions the file position indicator for subsequent I/O operations.

A sequential read of a dynamic file is indicated by the NEXT phrase of the READ statement. A READ NEXT statement should follow the START statement since the READ NEXT statement reads the next record indicated by the current record pointer. Subsequent READ NEXT statements sequentially retrieve records until another START statement or random READ statement executes.

Example 6–31 processes a relative file containing 10 records. If the previous program examples in this chapter have been run, each record has a unique even number from 2 to 20 as its key. The program positions the record pointer (using

the START statement) to the cell corresponding to the value in INPUT-RECORD-KEY. The program's READ...NEXT statement retrieves the remaining valid records in the file for display on the terminal.

### Example 6–31 Reading a Relative File Dynamically

```
IDENTIFICATION DIVISION.  
PROGRAM-ID. REL06.  
ENVIRONMENT DIVISION.  
INPUT-OUTPUT SECTION.  
FILE-CONTROL.  
    SELECT FLAVORS ASSIGN TO "BRAND"  
        ORGANIZATION IS RELATIVE  
        ACCESS MODE IS DYNAMIC  
        RELATIVE KEY IS KETCHUP-MASTER-KEY.  
  
DATA DIVISION.  
FILE SECTION.  
FD FLAVORS.  
01 KETCHUP-MASTER          PIC X(50).  
WORKING-STORAGE SECTION.  
01 KETCHUP-MASTER-KEY     PIC 99.  
01 END-OF-FILE             PIC X VALUE "N".  
PROCEDURE DIVISION.  
A000-BEGIN.  
    OPEN I-O FLAVORS.  
    DISPLAY "Enter number".  
    ACCEPT KETCHUP-MASTER-KEY.  
    START FLAVORS KEY = KETCHUP-MASTER-KEY  
        INVALID KEY DISPLAY "Bad START statement"  
        GO TO A005-END-OF-JOB.  
    PERFORM A010-DISPLAY-RECORDS UNTIL END-OF-FILE = "Y".  
A005-END-OF-JOB.  
    DISPLAY "END OF JOB".  
    CLOSE FLAVORS.  
    STOP RUN.  
A010-DISPLAY-RECORDS.  
    READ FLAVORS NEXT RECORD AT END MOVE "Y" TO END-OF-FILE.  
    IF END-OF-FILE NOT = "Y" DISPLAY KETCHUP-MASTER.
```

## 6.4.3 Reading an Indexed File

Your program can read an indexed file sequentially, randomly, or dynamically.

### Reading an Indexed File Sequentially

Reading indexed records sequentially involves the following:

1. Specifying ORGANIZATION IS INDEXED in the Environment Division SELECT clause
2. Specifying ACCESS MODE IS SEQUENTIAL in the Environment Division SELECT clause
3. Opening the file for INPUT or I-O
4. Reading records from the beginning of the file as you would a sequential file (using a READ...AT END statement)

The READ statement makes the next logical record of an open file available to the program. It skips deleted records and sequentially reads and retrieves only valid records. When the at end condition occurs, execution of the READ statement is unsuccessful (see Chapter 7).

## Processing Files and Records

### 6.4 Reading Files

Example 6–32 reads an entire indexed file sequentially beginning with the first record in the file, displaying every record on the terminal.

#### Example 6–32 Reading an Indexed File Sequentially

```
IDENTIFICATION DIVISION.
PROGRAM-ID. INDEX03.
ENVIRONMENT DIVISION.
INPUT-OUTPUT SECTION.
FILE-CONTROL.
    SELECT FLAVORS      ASSIGN TO "DAIRY"
                        ORGANIZATION IS INDEXED
                        ACCESS MODE IS SEQUENTIAL
                        RECORD KEY IS ICE-CREAM-MASTER-KEY
                        ALTERNATE RECORD KEY IS ICE-CREAM-STORE-STATE
                                WITH DUPLICATES
                        ALTERNATE RECORD KEY IS ICE-CREAM-STORE-CODE.

DATA DIVISION.
FILE SECTION.
FD  FLAVORS.
01  ICE-CREAM-MASTER.
    02 ICE-CREAM-MASTER-KEY          PIC XXXX.
    02 ICE-CREAM-MASTER-DATA.
        03 ICE-CREAM-STORE-CODE     PIC XXXXX.
        03 ICE-CREAM-STORE-ADDRESS  PIC X(20).
        03 ICE-CREAM-STORE-CITY     PIC X(20).
        03 ICE-CREAM-STORE-STATE    PIC XX.

WORKING-STORAGE SECTION.
01  END-OF-FILE                    PIC X.

PROCEDURE DIVISION.
A000-BEGIN.
    OPEN INPUT FLAVORS.
A010-SEQUENTIAL-READ.
    PERFORM A100-READ-INPUT UNTIL END-OF-FILE = "Y".
A020-EOJ.
    DISPLAY "END OF JOB".
    STOP RUN.
A100-READ-INPUT.
    READ FLAVORS AT END MOVE "Y" TO END-OF-FILE.
    IF END-OF-FILE NOT = "Y"
        DISPLAY ICE-CREAM-MASTER
        STOP "Type CONTINUE to display next master".
```

#### Reading an Indexed File Randomly

Reading indexed records randomly involves the following:

1. Specifying ORGANIZATION IS INDEXED in the Environment Division SELECT clause
2. Specifying ACCESS MODE IS RANDOM in the Environment Division SELECT clause
3. Opening the file for INPUT or I-O
4. Initializing the RECORD KEY or ALTERNATE RECORD KEY data name before reading the record
5. Reading the record using the KEY IS clause

To read the file randomly, the program must initialize either the primary key data name or the alternate key data name before reading the target record, and specify that data name in the KEY IS phrase of the READ statement.

The READ statement selects a specific record from an open file and makes it available to the program. The value of the primary or alternate key identifies the specific record. The system randomly reads the record identified by the KEY clause. If the I/O system does not find a valid record, the invalid key condition occurs, and the READ statement fails (see Chapter 7).

Example 6–33 reads an indexed file randomly, displaying its contents on the terminal.

**Example 6–33 Reading an Indexed File Randomly**

```
IDENTIFICATION DIVISION.
PROGRAM-ID. INDEX04.
ENVIRONMENT DIVISION.
INPUT-OUTPUT SECTION.
FILE-CONTROL.
    SELECT FLAVORS      ASSIGN TO "DAIRY"
                        ORGANIZATION IS INDEXED
                        ACCESS MODE IS RANDOM
                        RECORD KEY IS ICE-CREAM-KEY.

DATA DIVISION.
FILE SECTION.
FD  FLAVORS.
01  ICE-CREAM-MASTER.
    02  ICE-CREAM-KEY          PIC XXXX.
    02  ICE-CREAM-DATA.
        03  ICE-CREAM-STORE-CODE  PIC XXXXX.
        03  ICE-CREAM-STORE-ADDRESS PIC X(20).
        03  ICE-CREAM-STORE-CITY  PIC X(20).
        03  ICE-CREAM-STORE-STATE  PIC XX.
WORKING-STORAGE SECTION.
01  PROGRAM-STAT          PIC X.
    88  OPERATOR-STOPS-IT  VALUE "1".
PROCEDURE DIVISION.
A000-BEGIN.
    OPEN I-O FLAVORS.
    PERFORM A020-INITIAL-PROMPT.
    IF OPERATOR-STOPS-IT
        PERFORM A005-TERMINATE.
    PERFORM A030-RANDOM-READ.
    PERFORM A025-SUBSEQUENT-PROMPTS UNTIL OPERATOR-STOPS-IT.
    DISPLAY "END OF JOB".
    STOP RUN.
A020-INITIAL-PROMPT.
    DISPLAY "Do you want to see a store?".
    PERFORM A040-GET-ANSWER UNTIL PROGRAM-STAT = "Y" OR "y" OR "N" OR "n".
    IF PROGRAM-STAT = "N" OR "n"
        MOVE "1" TO PROGRAM-STAT.
A025-SUBSEQUENT-PROMPTS.
    MOVE SPACE TO PROGRAM-STAT.
    DISPLAY "Do you want to see another store?".
    PERFORM A040-GET-ANSWER UNTIL PROGRAM-STAT = "Y" OR "y" OR "N" OR "n".
    IF PROGRAM-STAT = "Y" OR "y"
        PERFORM A030-RANDOM-READ
    ELSE
        MOVE "1" TO PROGRAM-STAT.
A030-RANDOM-READ.
    DISPLAY "Enter key".
    ACCEPT ICE-CREAM-KEY.
    PERFORM A100-READ-INPUT-BY-KEY.
```

(continued on next page)

## Processing Files and Records

### 6.4 Reading Files

#### Example 6–33 (Cont.) Reading an Indexed File Randomly

```
A040-GET-ANSWER.  
    DISPLAY "Please answer Y or N"  
    ACCEPT PROGRAM-STAT.  
A100-READ-INPUT-BY-KEY.  
    READ FLAVORS KEY IS ICE-CREAM-KEY  
        INVALID KEY DISPLAY "Record does not exist - Try again"  
        NOT INVALID KEY DISPLAY "The record is: ", ICE-CREAM-MASTER.  
A005-TERMINATE.  
    DISPLAY "terminated".
```

#### Reading an Indexed File Dynamically

The READ statement has two formats, so it can select the next logical record (sequential access) or select a specific record (random access) and make it available to the program. In dynamic mode, the program can switch from using random access I/O statements to sequential access I/O statements, in any order and any number of times, without closing and reopening files. However, the program must use the READ NEXT statement to sequentially read an indexed file opened in dynamic mode.

Sequential processing need not begin at the first record of an indexed file. The START statement specifies the next record to be read sequentially, selects which key to use to determine the logical sort order, and repositions the file position indicator for subsequent I/O operations anywhere within the file.

A sequential read of a dynamic file is indicated by the NEXT phrase of the READ statement. A READ NEXT statement should follow the START statement since the READ NEXT statement reads the next record indicated by the file position indicator. Subsequent READ NEXT statements sequentially retrieve records until another START statement or random READ statement executes.

Example 6–34 processes an indexed file containing 26 records. Each record has a unique letter of the alphabet as its primary key. The program positions the file to the first record whose INPUT-RECORD-KEY is equal to the specified letter of the alphabet. The program's READ NEXT statement sequentially retrieves the remaining valid records in the file for display on the terminal.

#### Example 6–34 Reading an Indexed File Dynamically

```
IDENTIFICATION DIVISION.  
PROGRAM-ID. INDEX05.  
ENVIRONMENT DIVISION.  
INPUT-OUTPUT SECTION.  
FILE-CONTROL.  
    SELECT IND-ALPHA ASSIGN TO "ALPHA"  
        ORGANIZATION IS INDEXED  
        ACCESS MODE IS DYNAMIC  
        RECORD KEY IS INPUT-RECORD-KEY.  
  
DATA DIVISION.  
FILE SECTION.  
FD IND-ALPHA.  
01 INPUT-RECORD.  
    02 INPUT-RECORD-KEY          PIC X.  
    02 INPUT-RECORD-DATA        PIC X(50).  
WORKING-STORAGE SECTION.  
01 END-OF-FILE                  PIC X.
```

(continued on next page)



**Example 6–34 (Cont.) Reading an Indexed File Dynamically**

```
PROCEDURE DIVISION.  
A000-BEGIN.  
    OPEN I-O IND-ALPHA.  
    DISPLAY "Enter letter"  
    ACCEPT INPUT-RECORD-KEY.  
    START IND-ALPHA KEY = INPUT-RECORD-KEY  
        INVALID KEY DISPLAY "BAD START STATEMENT"  
        NOT INVALID KEY  
    PERFORM A100-GET-RECORDS THROUGH A100-GET-RECORDS-EXIT  
        UNTIL END-OF-FILE = "Y" END-START.  
A010-END-OF-JOB.  
    DISPLAY "END OF JOB".  
    CLOSE IND-ALPHA.  
    STOP RUN.  
A100-GET-RECORDS.  
    READ IND-ALPHA NEXT RECORD AT END MOVE "Y" TO END-OF-FILE.  
    IF END-OF-FILE NOT = "Y" DISPLAY INPUT-RECORD.  
A100-GET-RECORDS-EXIT.  
    EXIT.
```

On Alpha and I64, READ PRIOR retrieves from an Indexed file a record that logically precedes the one made current by the previous file access operation, if such a logically previous record exists. READ PRIOR can only be used with a file whose organization is INDEXED and whose access mode is DYNAMIC. The file must be opened for INPUT or I-O. Example 6–35 is an example of READ PRIOR in a program.

**Example 6–35 Reading an Indexed File Dynamically, with READ PRIOR  
(Alpha, I64)**

```
IDENTIFICATION DIVISION.  
PROGRAM-ID. READ PRIOR.  
ENVIRONMENT DIVISION.  
INPUT-OUTPUT SECTION.  
FILE-CONTROL.  
    SELECT F ASSIGN TO "READPR"  
        ORGANIZATION IS INDEXED  
        ACCESS IS DYNAMIC  
        RECORD KEY IS K0  
        ALTERNATE RECORD IS K2 DUPLICATES.  
DATA DIVISION.  
FILE SECTION.  
FD F.  
01 R.  
    02 K0 PIC X(3).  
    02 FILLER PIC X(5).  
    02 K2 PIC X(2).  
PROCEDURE DIVISION.  
P0. DISPLAY "***READ_PRIOR***".  
*+  
* Indexed file creation: After this load, the indexed file  
* contains the following records : 0123456789, 1234567890,  
* 2345678990, and 9876543291
```

(continued on next page)

## Processing Files and Records

### 6.4 Reading Files

#### Example 6–35 (Cont.) Reading an Indexed File Dynamically, with READ PRIOR (Alpha, I64)

```
*+
OPEN OUTPUT F.
MOVE "0123456789" TO R.
WRITE R INVALID KEY DISPLAY "?1".
MOVE "1234567890" TO R.
WRITE R INVALID KEY DISPLAY "?2".
MOVE "2345678990" TO R.
WRITE R INVALID KEY DISPLAY "?3".
MOVE "9876543291" TO R.
WRITE R INVALID KEY DISPLAY "?4".
CLOSE F.
*+
* READ PREVIOUS immediately after file open for IO
*+
OPEN I-O F.
MOVE "000" TO K0.
READ F PREVIOUS AT END GO TO P1 END-READ.
DISPLAY "?5 " R.
P1. CLOSE F.
*+
* READ PREVIOUS after file open for IO, from a middle
* record to beginning record on primary key.
*+
OPEN I-O F.
MOVE "2345678990" TO R.
READ F INVALID KEY DISPLAY "?6" GO TO P2 END-READ.
IF R NOT = "2345678990" THEN DISPLAY "?7 " R.
READ F PREVIOUS AT END DISPLAY "?8" GO TO P2 END-READ.
IF R NOT = "1234567890" THEN DISPLAY "?9 " R.
READ F PREVIOUS AT END DISPLAY "?10" GO TO P2 END-READ.
IF R NOT = "0123456789" THEN DISPLAY "?11 " R.
READ F PREVIOUS AT END GO TO P2.
DISPLAY "?12 " R.
*+
* Multiple READ PREVIOUS on a display alternate key with
* duplicates.
*+
P2. MOVE "91" TO K2.
READ F KEY K2 INVALID KEY DISPLAY "?13" GO TO P5 END-READ.
R NOT = "9876543291" THEN DISPLAY "?14 " R.
READ F PREVIOUS AT END DISPLAY "?15" GO TO P5 END-READ.
IF R NOT = "2345678990" THEN DISPLAY "?16 " R.
READ F PREVIOUS AT END DISPLAY "?17" GO TO P5 END-READ.
IF R NOT = "1234567890" THEN DISPLAY "?18 " R.
READ F PREVIOUS AT END DISPLAY "?19" GO TO P5 END-READ.
IF R NOT = "0123456789" THEN DISPLAY "?20 " R.
READ F PREVIOUS AT END GO TO P5.
DISPLAY "?21 " R.
P5. CLOSE F.
DISPLAY "***END***".
STOP RUN.      ◆
```

Example 6–36 is another example of READ PRIOR. This example contrasts how duplicates are handled with a DESCENDING key and with READ PRIOR. Also, this example shows how to use START before initiating a sequence of either READ NEXT statements or READ PRIOR statements. This example highlights how to use START, if you switch between READ NEXT and READ PRIOR.

**Example 6–36 Another Example of READ PRIOR (Alpha, I64)**

```
***READ_PRIOR2***
Read ascending key
a1
b2
c2
d2
e3
Read descending key
e3
b2
c2
d2
a1
Read prior
e3
d2
c2
b2
a1
***END***

IDENTIFICATION DIVISION.
PROGRAM-ID. READ_PRIOR2.
ENVIRONMENT DIVISION.
INPUT-OUTPUT SECTION.
FILE-CONTROL.
    SELECT OPTIONAL F1
    ASSIGN TO "READPR"
    ORGANIZATION IS INDEXED
    ACCESS MODE IS DYNAMIC
    RECORD KEY IS K1 = W2  ASCENDING WITH DUPLICATES
    ALTERNATE
    RECORD KEY IS K2 = W2  DESCENDING WITH DUPLICATES.
DATA DIVISION.
FILE SECTION.
FD F1.
01 R1.
    02 W1 PIC X.
    02 W2 PIC X.
PROCEDURE DIVISION.
P0. DISPLAY "***READ_PRIOR2***".
*+
* Indexed file creation.
*_-
    OPEN OUTPUT F1.
    MOVE "a1" TO R1.
    WRITE R1 INVALID KEY DISPLAY "?a1".
    MOVE "b2" TO R1.
    WRITE R1 INVALID KEY DISPLAY "?b2".
    MOVE "c2" TO R1.
    WRITE R1 INVALID KEY DISPLAY "?c2".
    MOVE "d2" TO R1.
    WRITE R1 INVALID KEY DISPLAY "?d2".
    MOVE "e3" TO R1.
    WRITE R1 INVALID KEY DISPLAY "?e3".
    CLOSE F1.
*+
* Read using ascending key.
*_-
    OPEN INPUT F1.
    DISPLAY "Read ascending key".
```

(continued on next page)

## Processing Files and Records

### 6.4 Reading Files

#### Example 6–36 (Cont.) Another Example of READ PRIOR (Alpha, I64)

```

MOVE "0" TO W2.
START F1 KEY IS GREATER THAN K1 INVALID KEY DISPLAY "?S1".
PERFORM 5 TIMES
    READ F1 NEXT AT END DISPLAY "?R2" END-READ
    DISPLAY R1
END-PERFORM.
CLOSE F1.
*+
* Read using descending key.
*_-
    OPEN INPUT F1.
    DISPLAY "Read descending key".
    MOVE "4" TO W2.
    START F1 KEY IS GREATER THAN K2 INVALID KEY DISPLAY "?S2".
    PERFORM 5 TIMES
        READ F1 NEXT AT END DISPLAY "?R2" END-READ
        DISPLAY R1
    END-PERFORM.
*+
* READ PRIOR - note the difference in duplicate order from
* Read with a descending key.
*_-
    DISPLAY "Read prior".
    MOVE "4" TO W2.
    START F1 KEY IS LESS THAN K1 INVALID KEY DISPLAY "?S3".
    PERFORM 5 TIMES
        READ F1 PRIOR AT END DISPLAY "?R3" END-READ
        DISPLAY R1
    END-PERFORM.
    CLOSE F1.
    DISPLAY "***END***".
    STOP RUN.

```

#### Reading an Indexed File from Other Languages on Tru64 UNIX

COBOL supports more data types for indexed keys than are supported in the ISAM definition. For keys in any of the data types not supported in the ISAM definition, the run-time system will translate those keys to strings. Table 6–7 specifies the appropriate mapping to create or use indexed files outside of COBOL (for example, if you are using the C language on Tru64 UNIX and you need to access COBOL files). Refer to the ISAM package documentation for details of the file format.

**Table 6–7 Indexed File—ISAM Mapping**

COBOL Data Type	Maps To	Transformation Method
character string PIC x(n)	CHARTYPE	None.
short signed int PIC S9(4) COMP	INTTYPE	C-ISAM
long signed int PIC S9(9) COMP	LONGTYPE	C-ISAM

(continued on next page)

**Table 6–7 (Cont.) Indexed File—ISAM Mapping**

COBOL Data Type	Maps To	Transformation Method
signed quadword PIC S9(18) COMP	CHARTYPE	Reverse the bytes (integers: most significant byte (msb) last; character strings: msb first).  If the data type is not <code>_UNSIGNED</code> , then complement the sign bit. This causes negative values to sort correctly with respect to each other, and precede positive values.
unsigned quadword PIC 9(18) COMP	CHARTYPE	Same as signed quadword.
packed decimal PIC S9(n) COMP-3	CHARTYPE	(Note that sign nibble after is the only case allowed in COBOL.) If the sign nibble is minus, complement all bits. This will give a sign nibble of 1 for a minus, which will come before the plus.  Copy the nibbles so the sign nibble is placed on the left and all the other nibbles are shifted one to the right.

Note that any data type not directly supported by ISAM is translated to a character string, which will sort as a character string in the correct order. ♦

## 6.5 Updating Files

Updating sequential, line sequential, relative, and indexed files includes the following tasks:

1. Opening the file
2. Executing a `READ` or `START` statement
3. Executing a `REWRITE` and a `DELETE` statement

Sections 6.5.1, 6.5.2, and 6.5.3 describe how to update sequential, relative, and indexed files.

### 6.5.1 Updating a Sequential File or Line Sequential (Alpha, I64) File

Updating a record in a sequential file involves the following:

1. Opening the file for I/O
2. Reading the target record
3. Rewriting the target record

The `REWRITE` statement places the record just read back into the file. The `REWRITE` statement completely replaces the contents of the target record with new data. You can use the `REWRITE` statement for files on mass storage devices only (for example, disk units). There are two ways of rewriting records:

- `REWRITE record-name FROM source-area`
- `REWRITE record-name`

## Processing Files and Records

### 6.5 Updating Files

Statements (1) and (2) in the following example are logically equivalent:

```
FILE SECTION.  
FD STOCK-FILE.  
01 STOCK-RECORD PIC X(80).  
WORKING-STORAGE SECTION.  
01 STOCK-WORK PIC X(80).  
  
----- (1) ----- (2) -----  
REWRITE STOCK-RECORD FROM STOCK-WORK. MOVE STOCK-WORK TO STOCK-RECORD.  
REWRITE STOCK-RECORD.
```

When you omit the FROM phrase, you process the records directly in the record area or buffer (for example, STOCK-RECORD).

For a REWRITE statement on a sequential file, the record being rewritten must be the same length as the record being replaced.

Example 6-37 reads a sequential file and rewrites as many records as the operator wants.

#### Example 6-37 Rewriting a Sequential File

```
IDENTIFICATION DIVISION.  
PROGRAM-ID. SEQ03.  
ENVIRONMENT DIVISION.  
INPUT-OUTPUT SECTION.  
FILE-CONTROL.  
    SELECT TRANS-FILE ASSIGN TO "TRANS".  
DATA DIVISION.  
FILE SECTION.  
FD TRANS-FILE.  
01 TRANSACTION-RECORD PIC X(25).  
WORKING-STORAGE SECTION.  
01 ANSWER PIC X.  
PROCEDURE DIVISION.  
A000-BEGIN.  
    OPEN I-O TRANS-FILE.  
    PERFORM A100-READ-TRANS-FILE  
        UNTIL TRANSACTION-RECORD = "END".  
    CLOSE TRANS-FILE.  
    STOP RUN.  
A100-READ-TRANS-FILE.  
    READ TRANS-FILE AT END  
        MOVE "END" TO TRANSACTION-RECORD.  
    IF TRANSACTION-RECORD NOT = "END"  
        PERFORM A300-GET-ANSWER UNTIL ANSWER = "Y" OR "N"  
            IF ANSWER = "Y" DISPLAY "Please enter new record content"  
                ACCEPT TRANSACTION-RECORD  
                REWRITE TRANSACTION-RECORD.  
A300-GET-ANSWER.  
    DISPLAY "Do you want to replace this record? -- "  
        TRANSACTION-RECORD.  
    DISPLAY "Please answer Y or N".  
    ACCEPT ANSWER.
```

You cannot open a line sequential file (Alpha, I64) for I-O or use the REWRITE statement. ♦

### Extending a Sequential File or Line Sequential File (Alpha, I64)

To position a file to its current end, and to allow the program to write new records beyond the last record in the file, use both:

- The EXTEND phrase of the OPEN statement
- The WRITE statement

Example 6–38 shows how to extend a sequential file.

### Example 6–38 Extending a Sequential File or Line Sequential File (Alpha, I64)

```
IDENTIFICATION DIVISION.  
PROGRAM-ID. SEQ04.  
ENVIRONMENT DIVISION.  
INPUT-OUTPUT SECTION.  
FILE-CONTROL.  
    SELECT TRANS-FILE ASSIGN TO "TRANS".  
DATA DIVISION.  
FILE SECTION.  
FD  TRANS-FILE.  
01  TRANSACTION-RECORD    PIC X(25).  
PROCEDURE DIVISION.  
A000-BEGIN.  
    OPEN EXTEND TRANS-FILE.  
    PERFORM A100-WRITE-RECORD  
        UNTIL TRANSACTION-RECORD = "END".  
    CLOSE TRANS-FILE.  
    STOP RUN.  
A100-WRITE-RECORD.  
    DISPLAY "Enter next record - X(25)".  
    DISPLAY "Enter END to terminate the session".  
    DISPLAY "-----".  
    ACCEPT TRANSACTION-RECORD.  
    IF TRANSACTION-RECORD NOT = "END"  
        WRITE TRANSACTION-RECORD.
```

Without the EXTEND mode, an HP COBOL program would have to open the input file, copy it to an output file, and add records to the output file.

## 6.5.2 Updating a Relative File

A program updates a relative file with the WRITE, REWRITE, and DELETE statements. The WRITE statement adds a record to the file. Only the REWRITE and DELETE statements change the contents of records already existing in the file. In either case, adequate backup must be available in the event of error. Sections 6.5.2.1 and 6.5.2.2 explain how to rewrite and delete relative records, respectively.

### 6.5.2.1 Rewriting a Relative File

The REWRITE statement logically replaces a record in a relative file; the original contents of the record are lost. Two options are available for rewriting relative records:

- Sequential access mode rewriting
- Random access mode rewriting

## Processing Files and Records

### 6.5 Updating Files

#### Rewriting Relative Records in Sequential Access Mode

Rewriting relative records in sequential access mode involves the following:

1. Specifying ORGANIZATION IS RELATIVE in the Environment Division SELECT clause
2. Specifying ACCESS MODE IS SEQUENTIAL in the Environment Division SELECT clause
3. Opening the file for I-O
4. Using a START statement and then a READ statement to read the target record
5. Updating the record
6. Rewriting the record into its cell

Example 6–39 reads a relative record sequentially and displays the record on the terminal. The program then passes the record to an update routine that is not included in the example. The update routine updates the record, and passes the updated record back to the program illustrated in Example 6–39, which displays the updated record on the terminal and rewrites the record in the same cell.

#### Example 6–39 Rewriting Relative Records in Sequential Access Mode

```
IDENTIFICATION DIVISION.  
PROGRAM-ID. REL07.  
ENVIRONMENT DIVISION.  
INPUT-OUTPUT SECTION.  
FILE-CONTROL.  
    SELECT FLAVORS ASSIGN TO "BRAND"  
        ORGANIZATION IS RELATIVE  
        ACCESS MODE IS SEQUENTIAL  
        RELATIVE KEY IS KETCHUP-MASTER-KEY.  
  
DATA DIVISION.  
FILE SECTION.  
FD FLAVORS.  
01 KETCHUP-MASTER          PIC X(50).  
WORKING-STORAGE SECTION.  
01 KETCHUP-MASTER-KEY     PIC 99 VALUE 99.  
PROCEDURE DIVISION.  
A000-BEGIN.  
    OPEN I-O FLAVORS.  
    PERFORM A100-UPDATE-RECORD UNTIL KETCHUP-MASTER-KEY = 00.  
A005-EOJ.  
    DISPLAY "END OF JOB".  
    CLOSE FLAVORS.  
    STOP RUN.  
A100-UPDATE-RECORD.  
    DISPLAY "TO UPDATE A RECORD ENTER ITS RECORD NUMBER (ZERO to END)".  
    ACCEPT KETCHUP-MASTER-KEY WITH CONVERSION.  
    IF KETCHUP-MASTER-KEY IS NOT EQUAL TO 00  
        START FLAVORS KEY IS EQUAL TO KETCHUP-MASTER-KEY  
            INVALID KEY DISPLAY "BAD START"  
            STOP RUN.
```

(continued on next page)



**Example 6–39 (Cont.) Rewriting Relative Records in Sequential Access Mode**

```
                END-START
PERFORM A200-READ-FLAVORS
DISPLAY "*****BEFORE UPDATE*****"
DISPLAY KETCHUP-MASTER
*****
*
*       Update routine code here
*
*****
        DISPLAY "*****AFTER UPDATE*****"
        DISPLAY KETCHUP-MASTER
        REWRITE KETCHUP-MASTER.
A200-READ-FLAVORS.
        READ FLAVORS
        AT END DISPLAY "END OF FILE"
        GO TO A005-EOJ.
```

**Rewriting Relative Records in Random Access Mode**

Rewriting relative records in random access mode involves the following:

1. Specifying ORGANIZATION IS RELATIVE in the Environment Division SELECT clause
2. Specifying ACCESS MODE IS RANDOM (or DYNAMIC) in the Environment Division SELECT clause
3. Opening the file for I-O
4. Moving the relative record number value of the record you want to read to the RELATIVE KEY data name
5. Reading the record from the cell identified by the relative record number
6. Updating the record
7. Rewriting the record into the cell identified by the relative record number

During execution of the REWRITE statement, the I/O system randomly reads the record identified by the RELATIVE KEY IS clause. The REWRITE statement then places the successfully read record back into its cell in the file.

If the cell does not contain a valid record, or if the REWRITE operation is unsuccessful, the invalid key condition occurs, and the REWRITE operation fails (see Chapter 7).

Example 6–40 reads a relative record randomly, displays its contents on the terminal, updates the record, displays its updated contents on the terminal, and rewrites the record in the same cell.

**Example 6–40 Rewriting Relative Records in Random Access Mode**

```
IDENTIFICATION DIVISION.
PROGRAM-ID. REL08.
ENVIRONMENT DIVISION.
INPUT-OUTPUT SECTION.
FILE-CONTROL.
        SELECT FLAVORS ASSIGN TO "BRAND"
        ORGANIZATION IS RELATIVE
```

(continued on next page)

## Processing Files and Records

### 6.5 Updating Files

#### Example 6–40 (Cont.) Rewriting Relative Records in Random Access Mode

```
ACCESS MODE IS RANDOM
RELATIVE KEY IS KETCHUP-MASTER-KEY.

DATA DIVISION.
FILE SECTION.
FD FLAVORS.
01 KETCHUP-MASTER          PIC X(50).
WORKING-STORAGE SECTION.
01 KETCHUP-MASTER-KEY     PIC 99.
PROCEDURE DIVISION.
A000-BEGIN.
    OPEN I-O FLAVORS.
    PERFORM A100-UPDATE-RECORD UNTIL KETCHUP-MASTER-KEY = 00.
A005-EOJ.
    DISPLAY "END OF JOB".
    CLOSE FLAVORS.
    STOP RUN.
A100-UPDATE-RECORD.
    DISPLAY "TO UPDATE A RECORD ENTER ITS RECORD NUMBER".
    ACCEPT KETCHUP-MASTER-KEY.
    READ FLAVORS INVALID KEY DISPLAY "BAD READ"
        GO TO A005-EOJ.

    DISPLAY "*****BEFORE UPDATE*****".
    DISPLAY KETCHUP-MASTER.
*****
*
*           Update routine
*
*****
    DISPLAY "*****AFTER UPDATE*****".
    DISPLAY KETCHUP-MASTER.
    REWRITE KETCHUP-MASTER INVALID KEY DISPLAY "BAD REWRITE"
        GO TO A005-EOJ.
```

#### 6.5.2.2 Deleting Records from a Relative File

The DELETE statement logically removes an existing record from a relative file. After successfully removing a record from a file, the program cannot later access it. Two options are available for deleting relative records:

- Sequential access mode deletion
- Random access mode deletion

##### Deleting a Relative Record in Sequential Access Mode

Deleting a relative record in sequential access mode involves the following:

1. Specifying ORGANIZATION IS RELATIVE in the Environment Division SELECT clause
2. Specifying ACCESS MODE IS SEQUENTIAL in the Environment Division SELECT clause
3. Opening the file for I-O
4. Using a START statement to position the record pointer, or sequentially reading the file up to the target record
5. Deleting the last read record

Example 6-41 deletes relative records in sequential access mode.

**Example 6-41 Deleting Relative Records in Sequential Access Mode**

```
IDENTIFICATION DIVISION.  
PROGRAM-ID. REL09.  
ENVIRONMENT DIVISION.  
INPUT-OUTPUT SECTION.  
FILE-CONTROL.  
    SELECT FLAVORS ASSIGN TO "BRAND"  
        ORGANIZATION IS RELATIVE  
        ACCESS MODE IS SEQUENTIAL  
        RELATIVE KEY IS KETCHUP-MASTER-KEY.  
  
DATA DIVISION.  
FILE SECTION.  
FD FLAVORS.  
01 KETCHUP-MASTER          PIC X(50).  
WORKING-STORAGE SECTION.  
01 KETCHUP-MASTER-KEY     PIC 99 VALUE 1.  
PROCEDURE DIVISION.  
A000-BEGIN.  
    OPEN I-O FLAVORS.  
    PERFORM A010-DELETE-RECORDS UNTIL KETCHUP-MASTER-KEY = 00.  
A005-EOJ.  
    DISPLAY "END OF JOB".  
    CLOSE FLAVORS.  
  
    STOP RUN.  
A010-DELETE-RECORDS.  
    DISPLAY "TO DELETE A RECORD ENTER ITS RECORD NUMBER".  
    ACCEPT KETCHUP-MASTER-KEY.  
    IF KETCHUP-MASTER-KEY NOT = 00 PERFORM A200-READ-FLAVORS  
        DELETE FLAVORS RECORD.  
  
A200-READ-FLAVORS.  
    START FLAVORS  
        INVALID KEY DISPLAY "INVALID START"  
            STOP RUN.  
    READ FLAVORS AT END DISPLAY "FILE AT END"  
        GO TO A005-EOJ.
```

## Processing Files and Records

### 6.5 Updating Files

#### Deleting a Relative Record in Random Access Mode

Deleting a relative record in random access mode involves the following:

1. Specifying ORGANIZATION IS RELATIVE in the Environment Division SELECT clause
2. Specifying ACCESS MODE IS RANDOM in the Environment Division SELECT clause
3. Opening the file for I-O
4. Moving the relative record number value to the RELATIVE KEY data name
5. Deleting the record identified by the relative record number

If the file does not contain a valid record, an invalid key condition exists.

Example 6–42 deletes relative records in random access mode.

#### Example 6–42 Deleting Relative Records in Random Access Mode

```
IDENTIFICATION DIVISION.  
PROGRAM-ID. REL10.  
ENVIRONMENT DIVISION.  
INPUT-OUTPUT SECTION.  
FILE-CONTROL.  
    SELECT FLAVORS ASSIGN TO "BRAND"  
        ORGANIZATION IS RELATIVE  
        ACCESS MODE IS RANDOM  
        RELATIVE KEY IS KETCHUP-MASTER-KEY.  
  
DATA DIVISION.  
FILE SECTION.  
FD FLAVORS.  
01 KETCHUP-MASTER          PIC X(50).  
WORKING-STORAGE SECTION.  
01 KETCHUP-MASTER-KEY     PIC 99 VALUE 1.  
PROCEDURE DIVISION.  
A000-BEGIN.  
    OPEN I-O FLAVORS.  
    PERFORM A010-DELETE-RECORDS UNTIL KETCHUP-MASTER-KEY = 00.  
A005-EOJ.  
    DISPLAY "END OF JOB".  
    CLOSE FLAVORS.  
    STOP RUN.  
A010-DELETE-RECORDS.  
    DISPLAY "TO DELETE A RECORD ENTER ITS RECORD NUMBER".  
    ACCEPT KETCHUP-MASTER-KEY.  
    IF KETCHUP-MASTER-KEY NOT = 00  
        DELETE FLAVORS RECORD  
            INVALID KEY DISPLAY "INVALID DELETE"  
            STOP RUN.
```

#### 6.5.3 Updating an Indexed File

Updating a record in an indexed file in sequential access mode involves the following:

1. Reading the target record
2. Verifying that the record is the one you want to change
3. Changing the record
4. Rewriting or deleting the target record

A program updates an indexed file in random access mode by rewriting or deleting the record.

Three options are available for updating indexed records:

- Sequential access mode updating
- Random access mode updating
- Dynamic access mode updating

---

**Note**

---

A program cannot rewrite an existing record if it changes the contents of the primary key in that record. Instead, the program must delete the record and write a new record. Alternate key values can be changed at any time. However, the value of alternate keys must be unique unless the WITH DUPLICATES phrase is present.

---

### Updating an Indexed File Sequentially

Updating indexed records in sequential access mode involves the following:

1. Specifying ORGANIZATION IS INDEXED in the Environment Division SELECT clause
2. Specifying ACCESS MODE IS SEQUENTIAL in Environment Division SELECT clause
3. Opening the file for I-O
4. Reading records as you would a sequential file (use the READ statement with the AT END phrase)
5. Rewriting or deleting records using the INVALID KEY phrase

The READ statement makes the next logical record of an open file available to the program. It skips deleted records and sequentially reads and retrieves only valid records. When the at end condition occurs, execution of the READ statement is unsuccessful (see Chapter 7).

The REWRITE statement replaces the record just read, while the DELETE statement logically removes the record just read from the file.

Example 6–43 updates an indexed file sequentially.

### Example 6–43 Updating an Indexed File Sequentially

```
IDENTIFICATION DIVISION.  
PROGRAM-ID. INDEX06.  
ENVIRONMENT DIVISION.  
INPUT-OUTPUT SECTION.  
FILE-CONTROL.  
    SELECT FLAVORS      ASSIGN TO "DAIRY"  
                        ORGANIZATION IS INDEXED  
                        ACCESS MODE IS SEQUENTIAL  
                        RECORD KEY IS ICE-CREAM-MASTER-KEY  
                        ALTERNATE RECORD KEY IS ICE-CREAM-STORE-STATE  
                        WITH DUPLICATES  
                        ALTERNATE RECORD KEY IS ICE-CREAM-STORE-CODE.
```

(continued on next page)

## Processing Files and Records

### 6.5 Updating Files

#### Example 6–43 (Cont.) Updating an Indexed File Sequentially

```
DATA DIVISION.
FILE SECTION.
FD FLAVORS.
01 ICE-CREAM-MASTER.
   02 ICE-CREAM-MASTER-KEY          PIC XXXX.
   02 ICE-CREAM-MASTER-DATA.
     03 ICE-CREAM-STORE-CODE        PIC XXXXX.
     03 ICE-CREAM-STORE-ADDRESS     PIC X(20).
     03 ICE-CREAM-STORE-CITY        PIC X(20).
     03 ICE-CREAM-STORE-STATE       PIC XX.
WORKING-STORAGE SECTION.
01 END-OF-FILE                      PIC X.
01 REWRITE-KEY                      PIC XXXXX.
01 DELETE-KEY                       PIC XX.
01 NEW-ADDRESS                      PIC X(20).
PROCEDURE DIVISION.
A000-BEGIN.
  OPEN I-O FLAVORS.
  DISPLAY "Which store code do you want to find?".
  ACCEPT REWRITE-KEY.
  DISPLAY "What is its new address?".
  ACCEPT NEW-ADDRESS.
  DISPLAY "Which state do you want to delete?".
  ACCEPT DELETE-KEY.
  PERFORM A100-READ-INPUT UNTIL END-OF-FILE = "Y".
A020-EOJ.
  DISPLAY "END OF JOB".
  STOP RUN.
A100-READ-INPUT.
  READ FLAVORS AT END MOVE "Y" TO END-OF-FILE.
  IF END-OF-FILE NOT = "Y" AND
    REWRITE-KEY = ICE-CREAM-STORE-CODE
    PERFORM A200-REWRITE-MASTER.
  IF END-OF-FILE NOT = "Y" AND
    DELETE-KEY = ICE-CREAM-STORE-STATE
    PERFORM A300-DELETE-MASTER.
A200-REWRITE-MASTER.
  MOVE NEW-ADDRESS TO ICE-CREAM-STORE-ADDRESS.
  REWRITE ICE-CREAM-MASTER
    INVALID KEY DISPLAY "Bad rewrite - ABORTED"
    STOP RUN.
A300-DELETE-MASTER.
  DELETE FLAVORS.
```

#### Updating an Indexed File Randomly

Updating indexed records in random access mode involves the following:

1. Specifying ORGANIZATION IS INDEXED in the Environment Division SELECT clause
2. Specifying ACCESS MODE IS RANDOM in the Environment Division SELECT clause
3. Opening the file for I-O
4. Initializing the RECORD KEY or ALTERNATE RECORD KEY data name
5. Writing, rewriting, or deleting records using the INVALID KEY phrase

## Processing Files and Records 6.5 Updating Files

You do not need to first read a record to update or delete it. If the primary or alternate key you specify allows duplicates, only the first occurrence of a record with a matching value will be updated.

Example 6-44 updates an indexed file randomly.

### Example 6-44 Updating an Indexed File Randomly

```
IDENTIFICATION DIVISION.
PROGRAM-ID. INDEX07.
ENVIRONMENT DIVISION.
INPUT-OUTPUT SECTION.
FILE-CONTROL.
    SELECT FLAVORS      ASSIGN TO "DAIRY"
                        ORGANIZATION IS INDEXED
                        ACCESS MODE IS RANDOM
                        RECORD KEY IS ICE-CREAM-MASTER-KEY
                        ALTERNATE RECORD KEY IS ICE-CREAM-STORE-STATE
                                WITH DUPLICATES
                        ALTERNATE RECORD KEY IS ICE-CREAM-STORE-CODE.

DATA DIVISION.
FILE SECTION.
FD  FLAVORS.
01  ICE-CREAM-MASTER.
    02 ICE-CREAM-MASTER-KEY          PIC XXXX.
    02 ICE-CREAM-MASTER-DATA.
        03 ICE-CREAM-STORE-CODE      PIC XXXXX.
        03 ICE-CREAM-STORE-ADDRESS   PIC X(20).
        03 ICE-CREAM-STORE-CITY      PIC X(20).
        03 ICE-CREAM-STORE-STATE     PIC XX.

WORKING-STORAGE SECTION.
01  HOLD-ICE-CREAM-MASTER          PIC X(51).
01  PROGRAM-STAT                   PIC X.
    88 OPERATOR-STOPS-IT            VALUE "1".
    88 LETS-SEE-NEXT-STORE          VALUE "2".
    88 NO-MORE-DUPLICATES           VALUE "3".

PROCEDURE DIVISION.
A000-BEGIN.
    OPEN I-O FLAVORS.
    PERFORM A030-RANDOM-READ UNTIL OPERATOR-STOPS-IT.
A020-EOJ.
    DISPLAY "END OF JOB".
    STOP RUN.
A030-RANDOM-READ.
    DISPLAY "Enter key".
    ACCEPT ICE-CREAM-MASTER-KEY.
    PERFORM A100-READ-INPUT-BY-PRIMARY-KEY
        THROUGH A100-READ-INPUT-EXIT.
    DISPLAY " Do you want to terminate the session?".
    PERFORM A040-GET-ANSWER UNTIL PROGRAM-STAT = "Y" OR "N".
    IF PROGRAM-STAT = "Y" MOVE "1" TO PROGRAM-STAT.
```

(continued on next page)

## Processing Files and Records

### 6.5 Updating Files

#### Example 6–44 (Cont.) Updating an Indexed File Randomly

```
A040-GET-ANSWER.  
    DISPLAY "Please answer Y or N"  
    ACCEPT PROGRAM-STAT.  
A100-READ-INPUT-BY-PRIMARY-KEY.  
    READ FLAVORS KEY IS ICE-CREAM-MASTER-KEY  
        INVALID KEY DISPLAY "Master does not exist - Try again"  
        GO TO A100-READ-INPUT-EXIT.  
    DISPLAY ICE-CREAM-MASTER.  
    PERFORM A200-READ-BY-ALTERNATE-KEY UNTIL NO-MORE-DUPLICATES.  
A100-READ-INPUT-EXIT.  
    EXIT.  
A200-READ-BY-ALTERNATE-KEY.  
    DISPLAY "Do you want to see the next store in this state?".  
    PERFORM A040-GET-ANSWER UNTIL PROGRAM-STAT = "Y" OR "N".  
    IF PROGRAM-STAT = "Y"  
        MOVE "2" TO PROGRAM-STAT  
        READ FLAVORS KEY IS ICE-CREAM-STORE-STATE  
            INVALID KEY DISPLAY "No more stores in this state"  
            MOVE "3" TO PROGRAM-STAT.  
    IF LETS-SEE-NEXT-STORE AND  
        ICE-CREAM-STORE-STATE = "NY"  
        PERFORM A500-DELETE-RANDOM-RECORD.  
    IF LETS-SEE-NEXT-STORE AND  
        ICE-CREAM-STORE-STATE = "NJ"  
        MOVE "Monmouth" TO ICE-CREAM-STORE-CITY  
        PERFORM A400-REWRITE-RANDOM-RECORD.  
    IF LETS-SEE-NEXT-STORE AND  
        ICE-CREAM-STORE-STATE = "CA"  
        MOVE ICE-CREAM-MASTER TO HOLD-ICE-CREAM-MASTER  
        PERFORM A500-DELETE-RANDOM-RECORD  
        MOVE HOLD-ICE-CREAM-MASTER TO ICE-CREAM-MASTER  
        MOVE "AZ" TO ICE-CREAM-STORE-STATE  
        PERFORM A300-WRITE-RANDOM-RECORD.  
    IF PROGRAM-STAT = "N"  
        MOVE "3" TO PROGRAM-STAT.  
A300-WRITE-RANDOM-RECORD.  
    WRITE ICE-CREAM-MASTER  
        INVALID KEY DISPLAY "Bad write - ABORTED"  
        STOP RUN.  
A400-REWRITE-RANDOM-RECORD.  
    REWRITE ICE-CREAM-MASTER  
        INVALID KEY DISPLAY "Bad rewrite - ABORTED"  
        STOP RUN.  
A500-DELETE-RANDOM-RECORD.  
    DELETE FLAVORS  
        INVALID KEY DISPLAY "Bad delete - ABORTED"  
        STOP RUN.
```

#### Updating an Indexed File Dynamically

Updating indexed records in dynamic access mode involves the following:

1. Specifying ORGANIZATION IS INDEXED in the Environment Division SELECT clause
2. Specifying ACCESS MODE IS DYNAMIC in the Environment Division SELECT clause
3. Opening the file for I-O



4. Reading the records sequentially (using the `START` statement to position the record pointer and then using the `READ...NEXT` statement) or randomly (initializing the `RECORD KEY` or `ALTERNATE RECORD KEY` data name and then reading records in any order you want using the `INVALID KEY` phrase) (See Example 6–44.)
5. Rewriting or deleting records using the `INVALID KEY` phrase

For indexed files with duplicate primary keys values, rewriting and deleting work as if the file was opened in sequential access mode. You first read the record, then update or delete the record just read.

For indexed files without duplicates allowed on the primary key, rewriting and deleting work as if the file was opened in random access mode. Specify the value of the primary key data item to indicate the target record, then update or delete that record.

In dynamic access mode, the program can switch from using random access I/O statements to sequential access I/O statements in any order without closing and reopening files.

## 6.6 Backing Up Your Files

Files can become unusable if either of the following situations occur:

- Your disk file becomes corrupted by a hardware error.
- Your disk file becomes corrupted with bad data.

Proper backup procedures are the key to successful recovery. You should back up your disk file at some reasonable point (daily, weekly, or monthly, depending on file activity and value of data), and save all transactions until you create a new backup. In this way, you can easily recreate your disk file from your last backup file and transaction files whenever the need arises.



---

## Handling Input/Output Exception Conditions

Many types of exception conditions can occur when a program processes a file; not all of them are errors. The three categories of exception conditions are as follows:

- **AT END condition**—This is a normal condition when you access a file sequentially. However, if your program tries to read the file any time after having read the last logical record in the file, and there is no applicable Declarative USE procedure or AT END phrase, the program abnormally terminates when the next READ statement executes.
- **Invalid key condition**—When you process relative and indexed files, the invalid key condition is a normal condition if you plan for it with a Declarative USE procedure or INVALID KEY phrase. It is an abnormal condition that causes your program to terminate if there is no applicable Declarative USE procedure or INVALID KEY phrase.
- **All other conditions**—These can also be either normal conditions (if you plan for them with Declarative USE procedures) or abnormal conditions that cause your program to terminate.

Planning for exception conditions effectively increases program and programmer efficiency. A program with exception handling routines is more flexible than a program without them. Exception handling routines minimize operator intervention and often reduce or eliminate the time you need to spend debugging and rerunning your program.

This chapter introduces you to the tools you need to execute exception handling routines for sequential, relative, and indexed files as a normal part of your program. These tools are the AT END phrase, the INVALID KEY phrase, file status values, RMS completion codes (on OpenVMS systems), and Declarative USE procedures. The topics that follow explain how to use these tools in your programs:

- Planning for the AT END condition (Section 7.1)
- Planning for the Invalid Key condition (Section 7.2)
- Using file status values and OpenVMS RMS completion codes (Section 7.3)
- Using Declarative USE procedures (Section 7.4)

### 7.1 Planning for the AT END Condition

HP COBOL provides you the option of testing for this condition with the AT END phrase of the READ statement (for sequential, relative, and indexed files) and the AT END phrase of the ACCEPT statement.

## Handling Input/Output Exception Conditions

### 7.1 Planning for the AT END Condition

Programs often read sequential files from beginning to end. They can produce reports from the information in the file or even update it. However, the program must be able to detect the end of the file, so that it can continue normal processing at that point. If the program does not test for this condition when it occurs, and if no applicable Declarative USE procedure exists (see Section 7.4), the program terminates abnormally. The program must detect when no more data is available from the file so that it can perform its normal end-of-job processing and then close the file.

Example 7–1 shows the use of the AT END phrase with the READ statement for sequential, relative, and indexed files.

#### Example 7–1 Handling the AT END Condition

```
READ SEQUENTIAL-FILE AT END PERFORM A600-TOTAL-ROUTINES
                                PERFORM A610-VERIFY-TOTALS-ROUTINES
                                MOVE "Y" TO END-OF-FILE.
READ RELATIVE-FILE NEXT RECORD AT END PERFORM A700-CLEAN-UP-ROUTINES
                                CLOSE RELATIVE-FILE
                                STOP RUN.
READ INDEXED-FILE NEXT RECORD AT END DISPLAY "End of file"
                                DISPLAY "Do you want to continue?"
                                ACCEPT REPLY
                                PERFORM A700-CLEAN-UP-ROUTINES.
```

### 7.2 Planning for the Invalid Key Condition

The INVALID KEY clause is available for the HP COBOL DELETE, READ, REWRITE, START, and WRITE statements. (It does not apply to the READ NEXT statement.) An invalid key condition occurs whenever the I/O system cannot complete a DELETE, READ, REWRITE, START, or WRITE statement. When the condition occurs, execution of the statement that recognized it is unsuccessful, and the file is not affected.

For example, relative and indexed files use keys to access (retrieve or update) records. The program specifying random access must initialize a key before executing a DELETE, READ, REWRITE, START, or WRITE statement. If the key does not result in the successful execution of any one of these statements, the invalid key condition exists. This condition is fatal to the program, if the program does not check for the condition when it occurs and if no applicable Declarative USE procedure exists (see Section 7.4).

The invalid key condition, although fatal if not planned for, can be to your advantage when used properly. You can, as shown in Example 7–2, read through an indexed file for all records with a specific duplicate key and produce a report from the information in those records. You can also plan for an invalid key condition on the first attempt to find a record with a specified key value that is not present in the file. In this case, planning for the invalid key condition allows the program to continue its normal processing. You can also plan for the AT END condition when you have read and tested for the last of the duplicate records in the file, or when you receive the AT END condition for a subsequent read operation, indicating that no more records exist in the file.

## Handling Input/Output Exception Conditions

### 7.2 Planning for the Invalid Key Condition

#### Example 7–2 Handling the Invalid Key Condition

```
.
.
.
MOVE "SMITH" TO LAST-NAME TEST-LAST-NAME.
MOVE "Y" TO ANY-MORE-DUPLICATES.
PERFORM A500-READ-DUPLICATES
        UNTIL ANY-MORE-DUPLICATES = "N".
.
.
.
STOP RUN.

A500-READ-DUPLICATES.
  READ INDEXED-FILE RECORD INTO HOLD-RECORD
  KEY IS LAST-NAME
  INVALID KEY
        MOVE "N" TO ANY-MORE-DUPLICATES
        DISPLAY "Name not in file!"
  NOT INVALID KEY
        PERFORM A510-READ-NEXT-DUPLICATES
        UNTIL ANY-MORE-DUPLICATES = "N"
  END-READ.

A510-READ-NEXT-DUPLICATES.
  READ INDEXED-FILE NEXT RECORD
  AT END MOVE "N" TO ANY-MORE-DUPLICATES
  NOT AT END
        PERFORM A520-VALIDATE
  END-READ.
  IF ANY-MORE-DUPLICATES = "Y" PERFORM A700-PRINT.

A520-VALIDATE.
  IF LAST-NAME NOT EQUAL TEST-LAST-NAME
  MOVE "N" TO ANY-MORE-DUPLICATES.
  END READ.

A700-PRINT.
.
.
.
```

## 7.3 Using File Status Values and OpenVMS RMS Completion Codes

Your program can check for the specific cause of the failure of a file operation by checking for specific file status values in its exception handling routines. To obtain HP COBOL file status values, use the FILE STATUS clause in the file description entry.

On OpenVMS, to access RMS completion codes, use the HP COBOL special registers RMS-STS and RMS-STV, or RMS-CURRENT-STS and RMS-CURRENT-STV. ♦

### 7.3.1 File Status Values

The run-time execution of any HP COBOL file processing statement results in a two-digit file status value that reports the success or failure of the COBOL statement. To access this file status value, you must specify the FILE STATUS clause in the file description entry, as shown in Example 7–3.

## Handling Input/Output Exception Conditions

### 7.3 Using File Status Values and OpenVMS RMS Completion Codes

#### Example 7-3 Defining a File Status for a File

```
DATA DIVISION.  
FILE SECTION.  
FD INDEXED-FILE  
   FILE STATUS IS INDEXED-FILE-STATUS.  
01 INDEXED-RECORD      PIC X(50).  
WORKING-STORAGE SECTION.  
01 INDEXED-FILE-STATUS PIC XX.  
01 ANSWER              PIC X.
```

The program can access this file status variable, INDEXED-FILE-STATUS, anywhere in the Procedure Division, and depending on its value, take a specific course of action without terminating the program. Notice that in Example 7-4 (in paragraph A900-EXCEPTION-HANDLING-ROUTINE), the file status that was defined in Example 7-3 is used. However, not all statements allow you to access the file status value as part of the statement. Your program has two options:

- Build an error recovery routine into the statement. The relative and indexed file processing statements that allow you to do this within the INVALID KEY phrase are DELETE, READ, REWRITE, START, and WRITE (that is, all the record I-O verbs except READ NEXT). See Example 7-4.
- Define a Declarative USE procedure to handle the condition. This option is available for all file organizations and their I/O statements. (See Example 7-6, Example 7-7, and Example 7-8.)

## Handling Input/Output Exception Conditions

### 7.3 Using File Status Values and OpenVMS RMS Completion Codes

#### Example 7-4 Using the File Status Value in an Exception Handling Routine

```
PROCEDURE DIVISION.  
A000-BEGIN.  
.  
.  
.  
DELETE INDEXED-FILE  
    INVALID KEY MOVE "Bad DELETE" TO BAD-VERB-ID  
    PERFORM A900-EXCEPTION-HANDLING-ROUTINE.  
.  
.  
.  
READ INDEXED-FILE NEXT RECORD  
    AT END MOVE "Bad READ" TO BAD-VERB-ID  
    PERFORM A900-EXCEPTION-HANDLING-ROUTINE.  
.  
.  
.  
REWRITE INDEXED-RECORD  
    INVALID KEY MOVE "Bad REWRITE" TO BAD-VERB-ID  
    PERFORM A900-EXCEPTION-HANDLING-ROUTINE.  
.  
.  
.  
START INDEXED-FILE  
    INVALID KEY MOVE "Bad START" TO BAD-VERB-ID  
    PERFORM A900-EXCEPTION-HANDLING-ROUTINE.  
.  
.  
.  
WRITE INDEXED-RECORD  
    INVALID KEY MOVE "Bad WRITE" TO BAD-VERB-ID  
    PERFORM A900-EXCEPTION-HANDLING-ROUTINE.  
.  
.  
.  
A900-EXCEPTION-HANDLING-ROUTINE.  
    DISPLAY BAD-VERB-ID " - File Status Value = " INDEXED-FILE-STATUS.  
    PERFORM A905-GET-ANSWER UNTIL ANSWER = "Y" OR "N".  
    IF ANSWER = "N" STOP RUN.  
A905-GET-ANSWER.  
    DISPLAY "Do you want to continue?"  
    DISPLAY "Please answer Y or N"  
    ACCEPT ANSWER.
```

See Soft Record Locks for information about inspecting variables with soft record locks and Declarative USE procedures.

Each file processing statement described in the Procedure Division section of the *HP COBOL Reference Manual* contains a specific list of file status values in its Technical Notes section. In addition, all file status values are listed in an appendix in the *HP COBOL Reference Manual*.

#### 7.3.2 RMS Completion Codes (OpenVMS)

HP COBOL on OpenVMS checks for RMS completion codes after each file and record operation. If the code indicates anything other than unconditional success, HP COBOL maps the RMS completion code to a file status value. However, not all RMS completion codes map to distinct file status values. Many RMS completion codes map to File Status 30, a COBOL code for errors that have no specific file status value.

## Handling Input/Output Exception Conditions

### 7.3 Using File Status Values and OpenVMS RMS Completion Codes

HP COBOL provides the following six special exception condition registers, four of which are shown in Example 7–5:

- RMS-STS
- RMS-STV
- RMS-FILENAME
- RMS-CURRENT-STS
- RMS-CURRENT-STV
- RMS-CURRENT-FILENAME

These special registers supplement the file status values already available and allow the HP COBOL program to directly access RMS completion codes. For more information on RMS completion codes, refer to the *HP COBOL Reference Manual* and the *OpenVMS Record Management Services Reference Manual*.

You do not define these special registers in your program. As special registers, they are available whenever and wherever you need to use them in the Procedure Division. RMS-CURRENT-STS contains the RMS completion codes for the most recent file or record operation for any file. RMS-CURRENT-FILENAME contains the name of the current file by which it is known to the system, which can be the full file specification (directory, device, file name, and extension). RMS-CURRENT-STV contains other relevant information (refer to the *OpenVMS System Messages and Recovery Procedures Reference Manual*, an archived manual that is available on the OpenVMS Documentation CD-ROM.). When you access these three special registers, you must not qualify your reference to them. However, if you define more than one file in the program and intend to access RMS-STS, RMS-STV, and RMS-FILENAME, you must qualify your references to them by using the internal COBOL program's file name for the file that you intend to reference.

Notice the use of the WITH CONVERSION phrase of the DISPLAY statement in Example 7–5. This converts the PIC S9(9) COMP contents of the RMS Special Registers from binary to decimal digits for terminal display.

#### Example 7–5 Referencing RMS-STS, RMS-STV, RMS-CURRENT-STS, and RMS-CURRENT-STV Codes (OpenVMS)

```
.  
. .  
DATA DIVISION.  
FILE SECTION.  
FD FILE-1.  
01 RECORD-1          PIC X(50).  
FD FILE-2.  
01 RECORD-2          PIC X(50).  
WORKING-STORAGE SECTION.  
01 ANSWER             PIC X.  
01 STS                 PIC S9(9) COMP.  
01 STV                 PIC S9(9) COMP.
```

(continued on next page)



## Handling Input/Output Exception Conditions

### 7.3 Using File Status Values and OpenVMS RMS Completion Codes

#### Example 7-5 (Cont.) Referencing RMS-STS, RMS-STV, RMS-CURRENT-STS, and RMS-CURRENT-STV Codes (OpenVMS)

```
PROCEDURE DIVISION.
A000-BEGIN.
.
.
WRITE RECORD-1 INVALID KEY PERFORM A901-REPORT-FILE1-STATUS.
*
* The following PERFORM statement displays the RMS completion
* codes resulting from the above WRITE statement for FILE-1.
*
PERFORM A903-REPORT-RMS-CURRENT-STATUS.
.
.
.
WRITE RECORD-2 INVALID KEY PERFORM A902-REPORT-FILE2-STATUS.
*
* The following PERFORM statement displays the RMS completion
* codes resulting from the above WRITE statement for FILE-2.
*
PERFORM A903-REPORT-RMS-CURRENT-STATUS.
.
.
.
*
* The following PERFORM statement moves the RMS completion codes
* resulting from the above WRITE statement for FILE-2 to data
* fields that are explicitly defined within your program.
*
PERFORM A904-MOVE-RMS-STV-STV.
.
.
.
A901-REPORT-FILE1-STATUS.
*****
*
DISPLAY "RMS-STV = " RMS-STV OF FILE-1 WITH CONVERSION.
DISPLAY "RMS-STS = " RMS-STS OF FILE-1 WITH CONVERSION.
DISPLAY "RMS-FILENAME = " RMS-FILENAME OF FILE-1.
*
*****
PERFORM A999-GET-ANSWER UNTIL ANSWER = "Y" OR "N".
IF ANSWER = "N" STOP RUN.
A902-REPORT-FILE2-STATUS.
*****
*
DISPLAY "RMS-STV = " RMS-STV OF FILE-2 WITH CONVERSION.
DISPLAY "RMS-STS = " RMS-STS OF FILE-2 WITH CONVERSION.
DISPLAY "RMS-FILENAME = " RMS-FILENAME OF FILE-2.
*
*****
PERFORM A999-GET-ANSWER UNTIL ANSWER = "Y" OR "N".
IF ANSWER = "N" STOP RUN.
```

(continued on next page)

## Handling Input/Output Exception Conditions

### 7.3 Using File Status Values and OpenVMS RMS Completion Codes

#### Example 7-5 (Cont.) Referencing RMS-STS, RMS-STV, RMS-CURRENT-STS, and RMS-CURRENT-STV Codes (OpenVMS)

```
A903-REPORT-RMS-CURRENT-STATUS.  
*****  
*  
    DISPLAY "RMS-CURRENT-STS = " RMS-CURRENT-STS WITH CONVERSION.  
    DISPLAY "RMS-CURRENT-STV = " RMS-CURRENT-STV WITH CONVERSION.  
    DISPLAY "RMS-CURRENT-FILENAME = " RMS-CURRENT-FILENAME.  
*  
*****  
    PERFORM A999-GET-ANSWER UNTIL ANSWER = "Y" OR "N".  
    IF ANSWER = "N" STOP RUN.  
A904-MOVE-RMS-STS-STV.  
*****  
*  
    MOVE RMS-STS OF FILE-1 TO STS.  
    MOVE RMS-STV OF FILE-1 TO STV.  
*  
*****  
    PERFORM A999-GET-ANSWER UNTIL ANSWER = "Y" OR "N".  
    IF ANSWER = "N" STOP RUN.  
A999-GET-ANSWER.  
    DISPLAY "Do you want to continue?"  
    DISPLAY "Please answer Y or N"  
    ACCEPT ANSWER. ◆
```

## 7.4 Using Declarative USE Procedures

An applicable Declarative USE procedure executes whenever an I/O statement results in an exception condition (a file status value that does not begin with a zero (0)) and the I/O statement does not contain an AT END or INVALID KEY phrase. The AT END and INVALID KEY phrases take precedence over a Declarative USE procedure, but only for the I/O statement that includes the clause. For example, the AT END phrase takes effect only with File Status 10 and the INVALID KEY phrase takes effect only with File Status 23. Therefore, you can have specific I/O statement exception condition handling for a file and also include a Declarative USE procedure for general exception handling.

A Declarative USE procedure is a set of one or more special-purpose sections at the beginning of the Procedure Division. As shown in Example 7-6, the key word DECLARATIVES precedes the first of these sections, and the key words END DECLARATIVES follow the last.

## Handling Input/Output Exception Conditions

### 7.4 Using Declarative USE Procedures

#### Example 7–6 The Declaratives Skeleton

```
PROCEDURE DIVISION.  
DECLARATIVES.  
  .  
  .  
  .  
END DECLARATIVES.  
MAIN-BODY SECTION.  
BEGIN.  
  .  
  .  
  .
```

As shown in Example 7–7, a Declarative procedure consists of a section header, followed, in order, by a USE statement and one or more paragraphs.

#### Example 7–7 A Declarative USE Procedure Skeleton

```
  .  
  .  
  .  
PROCEDURE DIVISION.  
DECLARATIVES.  
D0-00-FILE-A-PROBLEM SECTION.  
  USE AFTER STANDARD ERROR PROCEDURE ON FILE-A.  
D0-01-FILE-A-PROBLEM.  
  .  
  .  
  .  
D0-02-FILE-A-PROBLEM.  
  .  
  .  
  .  
D0-03-FILE-A-PROBLEM.  
  .  
  .  
  .  
END DECLARATIVES.  
MAIN-BODY SECTION.  
BEGIN.  
  .  
  .  
  .
```

Declarative USE procedures can be either ordinary or global. Ordinary Declarative USE procedures have a limited scope; you can use them only in programs where they are originally introduced. Global Declarative USE procedures have a wider scope; you can use them in programs that introduce them as well as in programs that are contained within the introducing program.

In HP COBOL Declarative procedures, the conditions in the USE statements indicate when they execute. There are five conditions. One USE statement can have only one condition; therefore, if you need all five conditions in one program, you must use five separate USE procedures. These procedures and their corresponding conditions are as follows:

- **File name**—You can define a file name Declarative USE procedure for each file name. This procedure takes precedence over the next four procedures. It executes for any unsuccessful exception condition. (One USE statement can specify multiple file names.)

## Handling Input/Output Exception Conditions

### 7.4 Using Declarative USE Procedures

- **INPUT**—You can define only one INPUT Declarative USE procedure for each program. This procedure executes for any unsuccessful exception condition if: (1) the file is open for INPUT and (2) a file name Declarative USE procedure does not exist for that file.
- **OUTPUT**—You can define only one OUTPUT Declarative USE procedure for each program. This procedure executes for any unsuccessful exception condition if: (1) the file is open for OUTPUT and (2) a file name Declarative USE procedure does not exist for that file.
- **INPUT-OUTPUT**—You can define only one INPUT-OUTPUT Declarative USE procedure for each program. This procedure executes for any unsuccessful exception condition if: (1) the file is open for INPUT-OUTPUT (I-O) and (2) a file name Declarative USE procedure does not exist for that file.
- **EXTEND**—You can define only one EXTEND Declarative USE procedure for each program. This procedure executes for any unsuccessful exception condition if: (1) the file is open for EXTEND and (2) a file name Declarative USE procedure does not exist for that file.

Note that the USE statement itself does not execute; it defines the condition that causes the Declarative procedure to execute. Refer to the *HP COBOL Reference Manual* for more information about specifying Declarative procedures with the USE statement.

Example 7–8 shows you how to include a USE procedure for each of the conditions in your program. The example also contains explanatory comments for each.

#### Example 7–8 Five Types of Declarative USE Procedures

```
.
.
.
PROCEDURE DIVISION.
DECLARATIVES.
*****
D1-00-FILE-A-PROBLEM SECTION.
    USE AFTER STANDARD ERROR PROCEDURE ON FILE-A.
*
*
* If any file-access statement for FILE-A results in an
* error, D1-00-FILE-A-PROBLEM executes.
*
*
D1-01-FILE-A-PROBLEM.
    PERFORM D9-00-REPORT-FILE-STATUS.
.
.
.
```

(continued on next page)

## Handling Input/Output Exception Conditions 7.4 Using Declarative USE Procedures

### Example 7–8 (Cont.) Five Types of Declarative USE Procedures

```
*****
D2-00-FILE-INPUT-PROBLEM SECTION.
    USE AFTER STANDARD EXCEPTION PROCEDURE ON INPUT.
*
*
* If an error occurs for any file open
* in the INPUT mode except FILE-A,
* D2-00-FILE-INPUT-PROBLEM executes.
*
*
D2-01-FILE-INPUT-PROBLEM.
    PERFORM D9-00-REPORT-FILE-STATUS.
    .
    .
    .
*****
D3-00-FILE-OUTPUT-PROBLEM SECTION.
    USE AFTER STANDARD EXCEPTION PROCEDURE ON OUTPUT.
*
*
* If an error occurs for any file open
* in the OUTPUT mode except FILE-A,
* D3-00-FILE-OUTPUT-PROBLEM executes.
*
*
*
D3-01-FILE-OUTPUT-PROBLEM.
    PERFORM D9-00-REPORT-FILE-STATUS.
    .
    .
    .
*****
D4-00-FILE-I-O-PROBLEM SECTION.
    USE AFTER STANDARD EXCEPTION PROCEDURE ON I-O.
*
*
* If an error occurs for any file open
* in the INPUT-OUTPUT mode except FILE-A,
* D4-00-FILE-I-O-PROBLEM executes.
*
*
*
D4-01-FILE-I-O-PROBLEM.
    PERFORM D9-00-REPORT-FILE-STATUS.
    .
    .
    .
```

(continued on next page)

## Handling Input/Output Exception Conditions

### 7.4 Using Declarative USE Procedures

#### Example 7-8 (Cont.) Five Types of Declarative USE Procedures

```
*****
D5-00-FILE-EXTEND-PROBLEM SECTION.
    USE AFTER STANDARD EXCEPTION PROCEDURE ON EXTEND.
*
*
* If an error occurs for any file open
* in the EXTEND mode except FILE-A,
* D5-00-FILE-EXTEND-PROBLEM executes.
*
*
D5-01-FILE-EXTEND-PROBLEM.
    PERFORM D9-00-REPORT-FILE-STATUS.
    .
    .
    .
D9-00-REPORT-FILE-STATUS.
    .
    .
    .
END DECLARATIVES.
*****
A000-BEGIN SECTION.
BEGIN.
    .
    .
    .
```

## Sharing Files and Locking Records

This chapter includes the following information about sharing files and protecting records for sequential, relative, and indexed files:

- Controlling access to files and records (Section 8.1)
- Choosing X/Open standard (Alpha, I64) or Hewlett-Packard (HP) standard file sharing and record locking (Section 8.2)
- Ensuring successful file sharing (Section 8.3)
- Using record locking to control access to records (Section 8.4)

### 8.1 Controlling Access to Files and Records

In a data manipulation environment where many users and programs access the same data, file control must be applied to protect files from nonprivileged users, to permit the desired degree of file sharing, and to preserve data integrity in the files. For example, in Figure 8–1 many users and programs want to access data found in FILE-A.

**Figure 8–1 Multiple Access to a File**

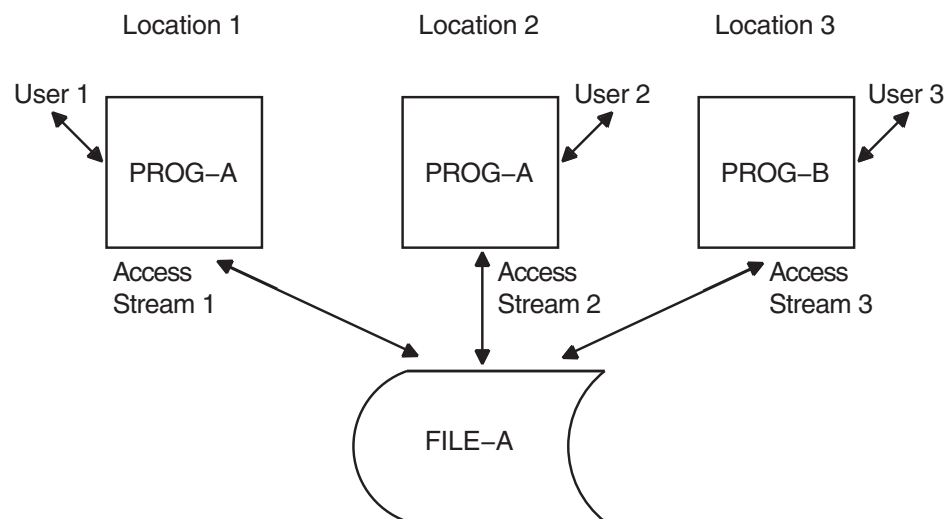

ZK-6323-GE

## Sharing Files and Locking Records

### 8.1 Controlling Access to Files and Records

File sharing and record locking allow you to control file and record operations when more than one **access stream** (the series of file and record operations being performed by a single user, using a single file connector) is concurrently accessing a file, as in Figure 8–1.

An HP COBOL program, via the I/O system, can define one or more access streams. You create one access stream with each OPEN file-name statement. The access stream remains active until you terminate it with the CLOSE file-name statement or until your program terminates.

**File sharing** allows multiple users (or access streams) to access a single file concurrently. The protection level of the file, set by the file owner, determines which users can share a file.

**Record locking** controls simultaneous record operations in files that are accessed concurrently. Record locking ensures that when a program is writing, deleting, or rewriting a record in a given access stream, another access stream is allowed to access the same record in a specified manner.

Figure 8–2 illustrates the relationship of record locking to file sharing.

**Figure 8–2 Relationship of Record Locking to File Sharing**

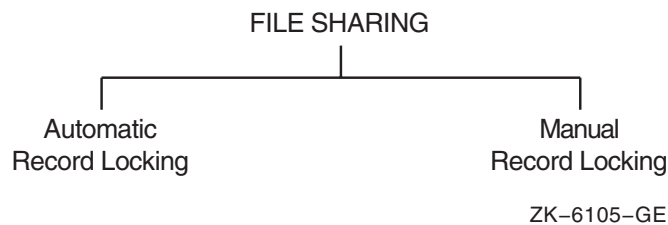

File sharing is a function of the file system, while record locking is a function of the I/O system. The file system manages file placement and the file-sharing process, in which multiple access streams simultaneously access a file. The I/O system manages the record-sharing process and provides access methods to records within a file. This includes managing the record-locking process, in which multiple access streams simultaneously access a record.

You must have successful file sharing before you can consider record locking.

In HP COBOL, the file operations begin with an OPEN statement and end with a CLOSE statement. The OPEN statement initializes an access stream and specifies the mode. The CLOSE statement terminates an access stream and can be either explicit (stated in the program) or implicit (on program termination).

---

**Note**

---

The first access stream to open a file determines how other access streams can access the file concurrently (if at all).

---

The record operations for HP COBOL that are associated with record locking are as follows:

READ  
START



WRITE  
REWRITE  
DELETE  
UNLOCK

## 8.2 Choosing a File Sharing and Record Locking Standard (Alpha, I64)

On Alpha and I64 systems, HP COBOL offers two methods of controlling potential conflicts of multi-user file access between simultaneously running processes:

- HP standard, which is compatible with the behavior of HP COBOL for OpenVMS VAX<sup>1</sup>
- X/Open standard (Alpha, I64), which conforms to the *X/Open CAE Specification: COBOL Language* and which offers X/Open portability

Both effectively control potential conflicts of file access between simultaneously running COBOL processes. Both offer locking for all file types: sequential, relative, and indexed.

---

**Note**

---

If you choose X/Open standard file sharing and record locking for a file connector, you must not use HP standard syntax anywhere in your program for the same file connector. The two are mutually exclusive.

---

The HP COBOL compiler determines whether to apply X/Open standard behavior or HP standard behavior for any file connector on the basis of the syntax used for that file connector. The following syntax identifies X/Open standard:

LOCK MODE (SELECT statement)  
WITH LOCK (OPEN statement)  
WITH [NO] LOCK (READ statement)  
UNLOCK RECORDS

The following syntax identifies Hewlett-Packard standard:

APPLY LOCK-HOLDING (Environment Division)  
ALLOWING<sup>1</sup>  
REGARDLESS<sup>1</sup> (Procedure Division)  
UNLOCK ALL

For any given file connector, any subsequent I-O locking syntax in your program must be consistent: X/Open standard and HP standard file sharing/record locking (implicit or explicit) cannot be mixed for the same file connector.

If a program includes any ambiguous semantics for I-O verbs (that is, no locking syntax for verbs for which the two standards provide different default behavior) and the previous code does not use HP or X/Open standard-specific syntax for that file connector, the compiler determines which standard to use by applying the specification (or default) from your compile command line, as follows:

- The `-std [no]xopen` flag on the `cobol` command for the Tru64 UNIX operating system

---

<sup>1</sup> Some exceptions exist on Tru64 UNIX. Refer to the *HP COBOL Reference Manual* for details.

## Sharing Files and Locking Records

### 8.2 Choosing a File Sharing and Record Locking Standard (Alpha, I64)

- The `/STANDARD=[NO]XOPEN` qualifier on the COBOL command for the OpenVMS Alpha and OpenVMS I64 operating systems

If you do not specify the flag or qualifier, the default is `noxopen` (HP standard) file sharing and record locking.

If you want X/Open file sharing and record locking and have not used the `LOCK MODE` clause, therefore, you should specify `/STANDARD=XOPEN` or `-std xopen` to ensure X/Open standard behavior in instances of conflicting default semantics. Note, however, that the qualifier/flag comes into effect only when the explicit syntax has not determined the usage. ♦

### 8.3 Ensuring Successful File Sharing

Successful file sharing requires that you:

- Provide disk residency for the file.
- Use the operating system file protection facility, namely the contents of `/etc/groups` (on Tru64 UNIX systems) or the UIC (on OpenVMS systems).
- Determine the intended access mode to the file (HP COBOL open modes).
- Indicate the file access allowed by other streams, using X/Open standard (on Alpha and I64 only) or HP standard syntax to specify file sharing.

The remainder of this section describes these requirements in more detail.

#### 8.3.1 Providing Disk Residency

Only files that reside on a disk can be shared. In HP COBOL you can share sequential, relative, and indexed files.

#### 8.3.2 Using File Protection

By applying the appropriate file permissions at the operating system level, the owner of a file determines how other users can access the file. An owner can permit different types of file access for different users or groups.

---

**Note**

---

The following OpenVMS operating system file protection access types are not a part of HP COBOL syntax.

---

The four types of file access are as follows:

- `READ`—Permits the reading of the records in the file.
- `WRITE`—Permits updating or extending the records in the file.
- `EXECUTE`—Applies to on-disk volume protection and image execution and is therefore not applicable to an HP COBOL program except through system service routines.
- `DELETE`—Permits deletion of the file and is therefore not applicable to an HP COBOL program (since HP COBOL has no delete file facility) except through system service routines.

## Sharing Files and Locking Records

### 8.3 Ensuring Successful File Sharing

In the OpenVMS file protection facility, four different categories of users exist with respect to data structures and devices. A file owner determines which of the following user categories can share the file:

- **SYSTEM**—Users of the system whose group numbers are in the range 0 to the value of the MAXSYSGROUP parameter or who have certain I/O-related privileges
- **OWNER**—Users of the system whose UIC group and member numbers are identical to the UIC of the file owner
- **GROUP**—Users of the system whose group number is identical to the group number of the file owner
- **WORLD**—All other users of the system who are not included in the previous categories

The OpenVMS operating system applies a default protection to each newly created file unless the owner specifically requests modified protection.

For more information on file protection, refer to the *OpenVMS User's Manual*. ♦

---

#### Note

---

The following Tru64 UNIX operating system file access types are not a part of HP COBOL syntax.

---

On Tru64 UNIX systems, the three types of file access are as follows:

- **Read**—Permits the reading of the records in the file.
- **Write**—Permits updating or extending the records in the file.
- **Execute**—Applies to image execution and is therefore not applicable to an HP COBOL program.

There are three categories of users:

- **User**—Owner of the file
- **Group**—Users in the same group as the owner
- **Others**—All other users

HP COBOL determines the access permission for newly created files in the following manner:

1. The default access permissions are granted:
  - User and Group are granted read and write access.
  - Others are granted read access.
2. Then the file mode creation mask of the process creating the file is taken into account.

Additional information on file permission can be found in the Tru64 UNIX man pages for `chmod`, `ls`, `open`, and `umask`. ♦

## Sharing Files and Locking Records

### 8.3 Ensuring Successful File Sharing

#### 8.3.3 Determining the Intended Access Mode to a File

Once you establish disk residency and permission for a file, you can consider how the stream intends to access the file. You specify this intention by using the HP COBOL open and access modes.

The HP COBOL open modes are INPUT, OUTPUT, EXTEND, and I-O. The HP COBOL access modes are SEQUENTIAL, RANDOM, and DYNAMIC. The combination of open and access modes determines the operations intended on the file.

You must validate your HP COBOL intention against the file protection assigned by the file owner. For example, to use an OPEN INPUT clause requires that the file owner has granted read access privileges to the file. To use an OPEN OUTPUT or EXTEND clause requires write access privileges to the file. To use an OPEN I-O clause requires both read and write access privileges.

The following chart shows the relationship between open and access modes and intended HP COBOL operations. The word ANY indicates that all three access methods result in the same intentions.

Open Mode	Access Mode	Intended COBOL Operations
INPUT	ANY	READ, START
OUTPUT	ANY	WRITE
I-O	SEQUENTIAL	READ, START, REWRITE, DELETE
	RANDOM/DYNAMIC	READ, START, REWRITE, DELETE, WRITE
EXTEND	SEQUENTIAL	WRITE

#### Note

If the file protection does not permit the intended operations, file access is not granted, even if open and access modes are compatible.

File protection and open mode access apply to both the unshared and shared (multiple access stream) file environments. A file protection and intent check is made when the first access stream opens a file (in the unshared file environment), and again when the second and subsequent access streams open the file (in the shared file environment).

After you provide disk residency, specify permission, and determine the access mode to a file, you can specify the access allowed to other streams through file-sharing and record-locking techniques. The remainder of this chapter describes this access control.

#### 8.3.4 Specifying File Access Using X/Open Standard File Sharing (Alpha, I64)

X/Open standard file sharing is summarized in this section and fully described in the *HP COBOL Reference Manual* (Environment Division and Procedure Division chapters) and the *X/Open CAE Specification: COBOL Language*.

If you want a file in your COBOL program to utilize X/Open standard file sharing (probably for purposes of portability), you should include X/Open-specific syntax for the file in the Environment Division. Use one of the following:

```
LOCK MODE IS AUTOMATIC
LOCK MODE IS MANUAL
```

## Sharing Files and Locking Records

### 8.3 Ensuring Successful File Sharing

#### LOCK MODE IS EXCLUSIVE

You can also select X/Open file sharing by just specifying WITH LOCK on the OPEN or READ statements. However, it is recommended that you use the LOCK MODE clause to avoid ambiguity and maintain readability. If this is not done and any I-O verbs rely on default behavior that might result in ambiguity, you should compile your program with the X/Open option added to the compile command line.

Opened files can be exclusive or shareable, as specified by the LOCK MODE option of the SELECT clause (in the FILE-CONTROL paragraph of the Environment Division) or the OPEN statement. However, files opened in OUTPUT mode cannot be shared. To make a file shareable, specify one of the following:

- LOCK MODE IS AUTOMATIC [WITH LOCK ON RECORD]
- LOCK MODE IS MANUAL WITH LOCK ON MULTIPLE RECORDS (allowed only for indexed or relative files)

These forms allow other access streams to open the file.

To make the file unavailable to other processes, specify one of the following:

- LOCK MODE IS EXCLUSIVE
- WITH LOCK on the OPEN statement

This locks the file. Attempts by other access streams to open the file cause a file lock condition.

If the LOCK MODE clause and WITH LOCK phrase are both omitted, the default file sharing is as follows:

- Opened in INPUT mode: shareable
- Opened in I-O, EXTEND, or OUTPUT mode: exclusive

The WITH LOCK phrase overrides any LOCK MODE clause. This is useful to create an exclusive access stream for a file declared as shareable.

You can protect a shareable file's data by using record-locking syntax (described in Section 8.4.1).

Example 8–1 shows the use of X/Open standard file-sharing code and the results when files are opened.

#### Example 8–1 X/Open Standard Lock Modes and Opening Files (Alpha, I64)

```
FILE-CONTROL.  
  SELECT employee-file ASSIGN TO "EMPFIL"  
    LOCK MANUAL LOCK ON MULTIPLE RECORDS.  
  
  SELECT master-file ASSIGN TO "MASTFIL"  
    LOCK AUTOMATIC.  
  
  SELECT tran-file ASSIGN TO "TRANFIL"  
    LOCK MODE IS EXCLUSIVE.  
  
  SELECT job-codes ASSIGN TO "JOBFIL".  
    .  
    .  
    .
```

(continued on next page)

## Sharing Files and Locking Records

### 8.3 Ensuring Successful File Sharing

#### Example 8–1 (Cont.) X/Open Standard Lock Modes and Opening Files (Alpha, I64)

```
PROCEDURE-DIVISION.  
BEGIN.  
* The file is shareable per LOCK MODE specification:  
    OPEN I-O employee-file.  
* The file is exclusive during this access stream, overriding the  
* LOCK MODE specification:  
    OPEN I-O master-file WITH LOCK.  
* The file is exclusive per LOCK MODE; others cannot access it:  
    OPEN INPUT tran-file.  
* The file defaults to exclusive; others cannot access it:  
    OPEN EXTEND job-codes.    ◆
```

#### 8.3.5 Specifying File Access Using Hewlett-Packard Standard File Sharing

Hewlett-Packard standard file sharing is summarized in this section and fully described in the *HP COBOL Reference Manual* (Environment Division and Procedure Division chapters).

You use the `ALLOWING` clause of the `OPEN` statement to specify what other access streams are allowed to access that file. The forms of `OPEN ALLOWING` are as follows:

- `OPEN ALLOWING NO OTHERS`—Locks the file for exclusive access. Attempts by other access streams to access the file cause a file lock condition.
- `OPEN ALLOWING READERS`—Locks the file against operations that indicate intended write access (`OPEN I-O` and `OPEN EXTEND`). Other streams can use the `OPEN INPUT` statement to view the file. No updaters are permitted.

On Tru64 UNIX, this lock is limited for `INDEXED` files, as follows:

– Any stream

If automatic record locking was requested, the file has now been opened with manual record locking in an attempt to process `READERS`.

– First stream

If the open mode was `INPUT` (reader), subsequent non-exclusive updaters will get access to the file at `OPEN` time, but they will not be able to update the file at the record level.

If the mode is `EXTEND`, `I-O`, or `OUTPUT` (updater), the file lock acquired will not exclude other updaters that have specified full sharing of the file (with `ALLOWING {ALL,UPDATERS,WRITERS}`).

– Subsequent stream

If the mode is `EXTEND` or `OUTPUT` (updater), access to the file is granted instead of denied when a previous updater

## Sharing Files and Locking Records

### 8.3 Ensuring Successful File Sharing

stream has specified full sharing of the file (with ALLOWING {ALL,UPDATERS,WRITERS}).

If the mode is INPUT (reader), access to the file is granted instead of denied when a previous updater stream has specified full (ALL/UPDATERS/WRITERS) or partial (READERS) sharing of the file.

If the mode is I-O, access is denied as expected. ♦

- OPEN ALLOWING WRITERS or UPDATERS or ALL—Allows access by other streams. Other access streams can open the file in INPUT, EXTEND, and I-O modes.

HP COBOL also permits a list of OPEN ALLOWING options, separated by commas. The list results in the following equivalent ALLOWING specifications:

- ALLOWING WRITERS, UPDATERS becomes ALLOWING ALL
- ALLOWING READERS, UPDATERS becomes ALLOWING UPDATERS

The first access stream uses the ALLOWING clause to specify what other access streams can do. When the second and subsequent access streams attempt to open the file, the following checks occur:

1. The allowed options of this access stream are checked against the intended access of the previous streams.
2. The intended access of this access stream is checked against the allowed access of the previous streams.

For example, if the first access stream specifies the ALLOWING READERS clause, then a subsequent access stream that opens the file ALLOWING NO OTHERS would fail. Also, if the first access stream opens the file ALLOWING READERS, the following access stream that opens the file ALLOWING ALL and WITH I-O mode would fail, because the clause option and the I-O mode declare write intent to the file.

If you do not specify an ALLOWING clause on the OPEN statement, the default for files opened for INPUT is ALLOWING READERS, and the default for files opened for I-O, OUTPUT, or EXTEND mode is ALLOWING NO OTHERS.

#### Describing Types of Access Streams

You can establish several types of access streams. For example, two programs opening the same file represent two access streams to that file. Both programs begin with the file open, perform record operations, and then close the file.

#### Combining Related File-Sharing Criteria

This section summarizes the relationships among three of the file-sharing criteria (the first file-sharing requirement, disk residency, is not included).

The following chart shows the file protection and open mode requirements. For example, the file protection privilege READ (R) permits OPEN INPUT.

File Protection	Open Mode
R	INPUT
W	OUTPUT, EXTEND
RW	I-O, INPUT, OUTPUT, EXTEND

## Sharing Files and Locking Records

### 8.3 Ensuring Successful File Sharing

Remember that you specify intended operations through the first access stream. For the second and subsequent shared access to a file, you use the access intentions (open modes) and the **ALLOWING** clause to determine if and how a file is shared. Note that some streams can be locked out if their intentions are not compatible with those of the streams that have already been allowed entry to the file.

On OpenVMS, Table 8–1 shows the valid and invalid **OPEN ALLOWING** combinations between first and subsequent access streams. (The subsequent table is the equivalent for Tru64 UNIX systems.) The table assumes no file protection violations on the first stream.

**Table 8–1 File-Sharing Options (OpenVMS)**

FIRST STREAM	SUBSEQUENT STREAM						
Open mode: Allowing:	<b>UPDATE ALL</b>	<b>UPDATE READERS</b>	<b>UPDATE NONE</b>	<b>INPUT ALL</b>	<b>INPUT READERS</b>	<b>INPUT NONE</b>	<b>OUTPUT ALL READERS NONE</b>
<b>UPDATE ALL</b>	G	3	2	G	3	2	5
<b>UPDATE READERS</b>	4	3,4	2	G	3	2	5
<b>UPDATE NONE</b>	1	1,3	1,2	1	1,3	1,2	5
<b>INPUT ALL</b>	G	G	2	G	G	2	5
<b>INPUT READERS</b>	4	4	2	G	G	2	5
<b>INPUT NONE</b>	1	1	1,2	1	1	1,2	5
<b>OUTPUT ALL</b>	G	3	2	G	3	2	5
<b>OUTPUT READERS</b>	4	3,4	2	G	3	2	5
<b>OUTPUT NONE</b>	1	1,3	1,2	1	1,3	1,2	5

#### Legend

<b>UPDATE</b>	OPEN EXTEND or OPEN I-O
<b>INPUT</b>	OPEN INPUT
<b>OUTPUT</b>	OPEN OUTPUT
<b>ALL</b>	ALLOWING ALL or ALLOWING UPDATERS or ALLOWING WRITERS
<b>READERS</b>	ALLOWING READERS
<b>NONE</b>	ALLOWING NO OTHERS
<b>G</b>	Second stream successfully opens and file sharing is granted.



## Sharing Files and Locking Records

### 8.3 Ensuring Successful File Sharing

Legend	
1	Second stream is denied access to the file because the first stream requires exclusive access (the first stream specified NO OTHERS).
2	Second stream is denied access to the file because the second stream requires exclusive access (the second stream specified NO OTHERS).
3	Second stream is denied access to the file because the first stream intends to write, while the second stream specifies read-only sharing.
4	Second stream is denied access to the file because the second stream intends to write, while the first stream specifies read-only sharing.
5	No sharing; second will create new file version with OPEN OUTPUT.

◆

On Tru64 UNIX, Table 8–2 shows the valid and invalid OPEN ALLOWING combinations between first and subsequent access streams. The table assumes no file protection violations on the first stream.

**Table 8–2 File-Sharing Options (Tru64 UNIX)**

FIRST STREAM	SUBSEQUENT STREAM					
Open mode: Allowing:	UPDATE ALL	UPDATE READERS	UPDATE NONE	INPUT ALL	INPUT READERS	INPUT NONE
<b>UPDATE ALL</b>	G	5	2	G	5	2
<b>UPDATE READERS</b>	6	3,4	2	G	5	2
<b>UPDATE NONE</b>	1	1,3	1,2	1	1,3	1,2
<b>INPUT ALL</b>	G	G	2	G	G	2
<b>INPUT READERS</b>	7	7	2	G	G	2
<b>INPUT NONE</b>	1	1	1,2	1	1	1,2

Legend	
<b>UPDATE</b>	OPEN EXTEND or OPEN I-O
<b>INPUT</b>	OPEN INPUT
<b>OUTPUT</b>	OPEN OUTPUT
<b>ALL</b>	ALLOWING ALL or ALLOWING UPDATERS or ALLOWING WRITERS
<b>READERS</b>	ALLOWING READERS
<b>NONE</b>	ALLOWING NO OTHERS
<b>G</b>	Second stream successfully opens and file sharing is granted.
<b>1</b>	Second stream is denied access to the file because the first stream requires exclusive access (the first stream specified NO OTHERS).
<b>2</b>	Second stream is denied access to the file because the second stream requires exclusive access (the second stream specified NO OTHERS).

## Sharing Files and Locking Records

### 8.3 Ensuring Successful File Sharing

Legend	
3	Second stream is denied access to the file because the first stream intends to write, while the second stream specifies read-only sharing.
4	Second stream is denied access to the file because the second stream intends to write, while the first stream specifies read-only sharing.
5	No sharing; second will create new file version with OPEN OUTPUT.
6	For indexed files, when the first stream allows READERS, file lock does not exclude updaters allowing sharing. For files other than indexed, 4 applies.
7	For indexed files, the second stream is granted access but cannot update the file. For files other than indexed, 4 applies.

◆

In the following example, three streams illustrate some of the file-sharing rules:

```

STREAM 1          OPEN INPUT ALLOWING ALL
STREAM 2          OPEN INPUT ALLOWING READERS
STREAM 3          OPEN I-O ALLOWING UPDATERS
  
```

Stream 1 permits ALLOWING ALL; thus stream 2 can read the file. However, the third stream violates the intent of the second stream, because OPEN I-O implies a write intention that stream 2 disallows. Consequently, the third access stream receives a file locked error.

#### 8.3.6 Error Handling for File Sharing

This section describes error conditions, checking file operations for success or failure, some considerations when you specify the OPEN EXTEND statement, and related potential errors.

##### Error Conditions

Whether the syntax is X/Open standard (Alpha, I64) or HP standard, any file contention error results in an unsuccessful statement for which a USE procedure will be invoked. A “file-locked” condition results in an I-O status code of 91.

On Alpha and I64, it is invalid to specify both X/Open and HP standard file sharing for the same file connector. Any attempts are flagged by the compiler when they are detectable in a single compilation unit. Across compilation units, the run-time system detects and reports such violations. This restriction is true for explicit and implicit (default) usage. ◆

##### Checking File Operations

You can check the success or failure of a file open operation by using the File Status value (or, on OpenVMS systems, the RMS-STS value in an HP COBOL special register called RMS-STS).

Table 8–3 illustrates the file status values you frequently use in a file-sharing environment.

**Table 8–3 File Status Values Used in a File-Sharing Environment**

File Status Value	Meaning
00	Successful operation

(continued on next page)

## Sharing Files and Locking Records

### 8.3 Ensuring Successful File Sharing

**Table 8–3 (Cont.) File Status Values Used in a File-Sharing Environment**

File Status Value	Meaning
30	File protection violation
91	File is locked

File Status 00 indicates the completion of a successful operation.

File Status 30 might result from a violation of the file protection codes described in Section 8.3.2. To correct this condition, the file owner must reset the protection on the file or the directory that contains the file.

File Status 91 indicates that a previous access stream has denied access to the file. That previous access stream opened the file with locking attributes that conflict with the OPEN statement of the *subsequent* stream.

You can obtain the values that apply to file-sharing exceptions (or to successful file-sharing operations), as shown in Example 8–2.

#### Example 8–2 Program Segment for File Status Values

```
FILE-CONTROL.  
    SELECT FILE-NAME ASSIGN TO "fshare.dat"  
        FILE STATUS IS FILE-STAT.  
  
WORKING-STORAGE SECTION.  
01 FILE-STAT PIC XX.  
    88 FILE-OPENED VALUES "00", "05", "07".  
    88 FILE-LOCKED VALUE "91".  
01 RETRY-COUNT PIC 9(2).  
01 MAX-RETRY PIC 9(2) VALUE 10.  
    .  
    .  
    .  
PROCEDURE DIVISION.  
DECLARATIVES.  
FILE-USE SECTION.  
    USE AFTER STANDARD EXCEPTION PROCEDURE ON FILE-NAME.  
FILE-ERR.  
* need declaratives to trap condition, but let main code process it  
    IF FILE-LOCKED  
        CONTINUE  
    ELSE  
        .  
        .  
        .  
    END-IF.  
END DECLARATIVES.  
    .  
    .  
    .  
OPEN-FILES.  
    OPEN I-O FILE-NAME.  
    IF NOT FILE-OPENED  
        PERFORM CHECK-OPEN.  
    .  
    .  
    .
```

(continued on next page)

## Sharing Files and Locking Records

### 8.3 Ensuring Successful File Sharing

#### Example 8–2 (Cont.) Program Segment for File Status Values

```

CHECK-OPEN.
  IF FILE-LOCKED
    MOVE 1 to RETRY-COUNT
    PERFORM RETRY-OPEN UNTIL FILE-OPENED OR
      RETRY-COUNT > MAX-RETRY
  IF FILE-LOCKED AND RETRY-COUNT > MAX-RETRY
    DISPLAY "File busy...please try again later"
    STOP RUN
  END-IF
END-IF.

* handle other possible errors here
.
.
.
RETRY-OPEN.
  OPEN I-O FILE-NAME.
  add 1 to RETRY-COUNT.

```

On OpenVMS, Table 8–4 describes RMS-STS values used in a file-sharing environment.

**Table 8–4 RMS-STS Values Used in a File-Sharing Environment (OpenVMS)**

RMS-STS Value	Meaning
RMS\$_DIR	Error in directory name
RMS\$_DNF	Directory not found
RMS\$_DNR	Device not ready or not mounted
RMS\$_DUP	Duplicate key detected (DUP not set)
RMS\$_ENQ	System service request failed
RMS\$_EOF	End of file detected
RMS\$_FLK <sup>1</sup>	File is locked
RMS\$_FNF	File not found
RMS\$_FUL	Device full (insufficient space)
RMS\$_KEY	Invalid record number key or key value
RMS\$_KRF	Invalid key of reference for \$GET/\$FIND
RMS\$_KSZ	Invalid key size for \$GET/\$FIND
RMS\$_OK_RLK	Record locked but read anyway
RMS\$_OK_RRL	Record locked against read but read anyway
RMS\$_PRV <sup>2</sup>	File protection violation
RMS\$_RAC	Invalid record access mode
RMS\$_REX	Record already exists
RMS\$_RLK	Record currently locked by another stream
RMS\$_RNF	Record not found

<sup>1</sup>Corresponds to File Status Value of 91

<sup>2</sup>Corresponds to File Status Value of 30

(continued on next page)

## Sharing Files and Locking Records

### 8.3 Ensuring Successful File Sharing

**Table 8–4 (Cont.) RMS-STS Values Used in a File-Sharing Environment (OpenVMS)**

RMS-STS Value	Meaning
RMS\$_RNL	Record not locked
RMS\$_RSZ	Invalid record size
RMS\$_SNE	File sharing not enabled
RMS\$_SPE	File\$_sharing page count exceeded
RMS\$_SUC <sup>3</sup>	Successful operation
RMS\$_WLK	Device currently write locked

<sup>3</sup>Corresponds to File Status Value of 00

You can obtain the values that apply to file-sharing exceptions (or to successful file-sharing operations) by using the VALUE IS EXTERNAL clause, as shown in Example 8–3:

#### **Example 8–3 Program Segment for RMS-STS Values (OpenVMS)**

```
WORKING-STORAGE SECTION.
01 RMS-SUC      PIC S9(9) COMP VALUE IS EXTERNAL RMS$ SUC.
01 RMS-FLK     PIC S9(9) COMP VALUE IS EXTERNAL RMS$_FLK.
.
.
.
PROCEDURE DIVISION.
DECLARATIVES.
FILE-1-ERR SECTION.
    USE AFTER STANDARD EXCEPTION PROCEDURE ON FILE-1.
FILE-1-USE.
    EVALUATE RMS-STS OF FILE-1
        WHEN RMS-SUC      DISPLAY "successful operation"
        WHEN RMS-FLK     DISPLAY "file is locked - access denied".
.
.
.
♦
```

#### **Specifying the OPEN EXTEND Statement in a File-Sharing Environment**

If you specify an OPEN EXTEND in a file-sharing environment, be aware that the EXTEND results differ depending upon what file organization you use.

**OPEN EXTEND with a Shared Sequential File** In a shared sequential file environment, when two concurrent access streams open the file in EXTEND mode, and both streams issue a write to the end of the file (EOF), the additional data will come from both streams, and the data will be inserted into the file in the order in which it was written to the file.

**OPEN EXTEND with a Shared Relative File** You must use the sequential access mode when you open a relative file in extend mode. Sequential access mode for a relative file indicates that the record order is by ascending relative record number.

## Sharing Files and Locking Records

### 8.3 Ensuring Successful File Sharing

In sequential access mode for a relative file, the `RELATIVE KEY` clause of the `WRITE` statement is not used on record insertion; instead, the `RELATIVE KEY` clause acts as a receiving field. Consequently, after the completion of a write by the first access stream, the relative key field is set to the actual relative record number.

Figure 8–3 illustrates why this condition occurs.

**Figure 8–3 Why a Record-Already-Exists Error Occurs**

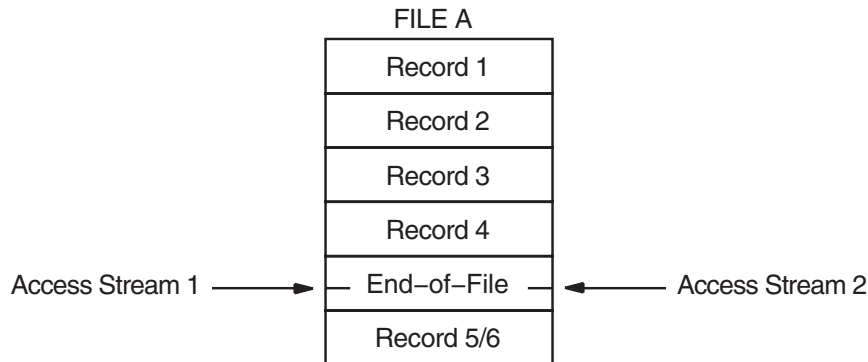

ZK-6060-GE

As the file operations begin, both access streams point to the end of file by setting record 4 as the highest relative record number in the file. When access stream 1 writes to the file, record 5 is created as the next ascending relative record number and 5 is returned as the `RELATIVE KEY` number.

When access stream 2 writes to the file, it also tries to write the fifth record. Record 5 already exists (inserted by the first stream), and the second access stream gets a record-exists error. Thus, in a file-sharing environment, the second access stream always receives a record-exists error. To gain access to the current highest relative record number, stream 2 must close the file and reopen it.

**OPEN EXTEND with a Shared Indexed File** You must use the sequential file access mode when you open an indexed file in extend mode. Sequential access mode requires that the first additional record insertion have a prime record key whose value is greater than the highest prime record key value in the file.

In a file-sharing environment, you should be aware of and prepared for duplicate key errors (by using `INVALID KEY` and `USE` procedures), especially on the first write to the file by the second access stream.

Subsequent writes should also allow for duplicate key errors, although subsequent writes are not constrained to use keys whose values are greater than the highest key value that existed at file open time. If you avoid duplicate key errors, you will successfully insert all access stream records.

## 8.4 Ensuring Successful Record Locking

Once you meet all of the file-sharing criteria and you access a file, you can consider two record-locking modes that control access to records in a file:

- Automatic record locking—The system automatically releases an existing record lock whenever a new record is accessed and acquires a record lock whenever it reads a record in the file.
- Manual record locking—A file connector can hold a number of record locks simultaneously. Manual record locking is available only for relative or indexed files.

---

**Note**

---

You must use the same method for record locking as for file sharing. For any single file connector, you cannot mix the X/Open standard (Alpha, I64) and the HP standard methods.

---

### 8.4.1 X/Open Standard Record Locking (Alpha, I64)

This section describes the X/Open standard method of specifying automatic or manual record locking.

#### **Specifying Automatic Record Locking (X/Open Standard) (Alpha, I64)**

You specify X/Open standard automatic record locking in the Environment Division by using `LOCK MODE IS AUTOMATIC [WITH LOCK ON RECORD]` on the `SELECT` statement. (The optional `WITH LOCK ON RECORD` clause has no effect and is for documentation only.) Subsequently, a record lock is acquired by the successful execution of a `READ` statement. (The `WITH LOCK` clause is not necessary on the `READ`; it is implied.)

A record lock is released by one of the following events:

- The successful execution of a subsequent I-O statement
- Using the `UNLOCK` statement
- Closing the file, implicitly or explicitly

In X/Open standard record locking, only the `READ` statement can acquire a lock. You can use the `WITH NO LOCK` phrase of the `READ` statement to prevent the acquiring of an automatic record lock.

For files opened in `INPUT` mode, `READ` and `READ WITH LOCK` statements do not acquire a record lock.

#### **Specifying Manual Record Locking (X/Open Standard) (Alpha, I64)**

You specify X/Open standard manual record locking in the Environment Division by using `LOCK MODE IS MANUAL WITH LOCK ON MULTIPLE RECORDS` on the `SELECT` statement. Manual record locking is available only for relative and indexed files.

For manual record locking, a record lock is acquired by specifying the `WITH LOCK` phrase on the `READ` statement. `READ` is the only operation that can acquire a lock. The record lock is released by one of the following events:

- Using the `UNLOCK` statement (any form of the `UNLOCK` statement unlocks all record locks held by the current access stream; there is no singular option)

## Sharing Files and Locking Records

### 8.4 Ensuring Successful Record Locking

- Closing the file, implicitly or explicitly

The WITH LOCK clause is ignored for files opened in INPUT mode. Locks are detected but not acquired.

Example 8–4 is a partial example of using both methods of X/Open standard record locking.

#### Example 8–4 X/Open Standard Record Locking (Alpha, I64)

##### User 1 (Automatic Record Locking):

```
-----  
FILE-CONTROL.  
    SELECT FILE-1  
        ORGANIZATION IS RELATIVE  
        ASSIGN TO "SHAREDAT.DAT"  
        LOCK MODE AUTOMATIC.  
    .  
    .  
    .  
PROCEDURE DIVISION.  
BEGIN.  
OPEN I-O FILE-1.  
READ FILE-1.  
    .  
    .  
    .  
REWRITE FILE-1-REC.  
CLOSE FILE-1.  
STOP RUN.
```

##### User 2 (Manual Record Locking):

```
-----  
FILE-CONTROL  
    SELECT FILE-1  
        ORGANIZATION IS RELATIVE  
        ASSIGN "SHAREDAT.DAT"  
        LOCK MODE MANUAL LOCK ON MULTIPLE RECORDS.  
    .  
    .  
    .  
PROCEDURE DIVISION.  
BEGIN.  
OPEN I-O FILE-1.  
    .  
    .  
    .  
READ FILE-1 WITH LOCK.  
REWRITE FILE-1-REC.  
UNLOCK FILE-1.  
CLOSE FILE-1.  
STOP RUN.
```

Note that User 2 could have employed AUTOMATIC record locking just as well. In this case, manual and automatic locking work similarly. ♦



### 8.4.2 Hewlett-Packard Standard Record Locking

#### **Automatic Record Locking (HP Standard)**

You specify automatic record locking by using the `ALLOWING` phrase of the `OPEN` statement. The lock is applied when you access the record and released when you deaccess the record. In automatic record locking the access stream can have only one record locked at a time and can apply only one type of lock to the records of the file.

You deaccess a record by using the next `READ` operation, a `REWRITE` or a `DELETE` operation on the record, or by closing the file. In addition, you can release locks applied by automatic record locking by using the `UNLOCK` statement.

In automatic record-locking mode, you can release the current record lock by using an `UNLOCK RECORD` statement or an `UNLOCK ALL RECORDS` statement. (On Tru64 UNIX systems for indexed files only, there is no current record lock.) However, because in automatic record locking you can lock only one record at a time, the `UNLOCK ALL RECORDS` statement unnecessarily checks all records for additional locks.

The sample program in Example 8–5 uses automatic record locking. The program opens the file with `I-O ALLOWING ALL`. Another access stream in another program also opens the file with `INPUT ALLOWING ALL`.

Note that two parallel access streams use the program in Example 8–5.

If the first access stream is updating records in random order, a record lock can occur to the second stream from the `READ` until the `REWRITE` statement of the first stream. Record locks can also occur to the first stream when the second stream reads a record and the first stream tries to read the same record.

#### **Example 8–5 Automatic Record Locking (HP Standard)**

```
SELECT FILE-1
  ORGANIZATION IS RELATIVE
  ASSIGN TO "SHAREDAT.DAT"
  .
  :
  .
PROCEDURE DIVISION.
  OPEN I-O FILE-1 ALLOWING ALL.
  READ FILE-1 AT END DISPLAY "end".
  .
  :
  .
  REWRITE FILE-1-REC.
  CLOSE FILE-1.
  STOP RUN.
```

When you close a file, any existing record lock is released automatically. The `UNLOCK RECORD` statement releases the lock only on the current record on OpenVMS systems, which is the last record you successfully accessed. On Tru64 UNIX systems for indexed files only, there is no current record lock.

## Sharing Files and Locking Records

### 8.4 Ensuring Successful Record Locking

#### Manual Record Locking (HP Standard)

You specify manual record locking by using the `APPLY LOCK-HOLDING` clause (in the `I-O-CONTROL` paragraph), the `OPEN ALLOWING` statement, and the `ALLOWING` clauses on the HP COBOL record operations (except `DELETE`). Manual record locking allows greater control of locking options by permitting users to lock multiple records in a file and by permitting different types of locking to apply to different records.

Manual record locking applies the specified lock when you access the record and releases the lock when you unlock the record.

When you specify manual record locking, you must use all of the following clauses:

- An `APPLY LOCK-HOLDING` clause in the `I-O CONTROL` paragraph
- An `OPEN ALLOWING` clause at file open time
- An `ALLOWING` clause on each record operation (except `DELETE`)<sup>2</sup>

The possible `ALLOWING` clauses for the record operations (that is, the `READ`, `WRITE`, `REWRITE`, and `START` statements) are as follows:

- `ALLOWING NO OTHERS`<sup>2</sup>—Locks records for exclusive access. Others cannot perform `READ`, `WRITE`, `DELETE`, or `UPDATE` statements. This clause constitutes a lock for write and does not allow readers.
- `ALLOWING READERS`—Locks records against `WRITE`, `REWRITE`, and `DELETE` access by all streams including the stream that issues the statement. Others can perform `READ` statements.
- `ALLOWING UPDATERS`<sup>2</sup>—Does not apply any locks to the records. Others can perform `READ`, `REWRITE`, and `DELETE` statements. This clause constitutes a no record lock condition. <sup>2</sup>

However, if the file's `OPEN` mode is `INPUT`, using the `ALLOWING` clause on the record operation does not lock the record.

On Tru64 UNIX systems, for indexed files only, the `WRITE`, `REWRITE`, and `START` statements do not acquire a record lock.

On Tru64 UNIX systems for indexed files only, `ALLOWING READERS` is treated as `ALLOWING NO OTHERS` if the file is opened in `I-O` mode or as `ALLOWING ALL` if the file is opened in `INPUT` mode. ♦

Table 8–5 shows the valid and invalid `ALLOWING` combinations for manual record locking. The columns represent the lock held, and the rows represent the lock requested.

---

<sup>2</sup> Some exceptions exist on Tru64 UNIX. Refer to the *HP COBOL Reference Manual* for details.

## Sharing Files and Locking Records

### 8.4 Ensuring Successful Record Locking

**Table 8–5 Manual Record Locking Combinations**

I-O Attempt (for subsequent stream)		Lock Held (for first stream)		
		Updaters	Readers	No Others
READ	Allowing Updaters	Y	Y	N
	Allowing Readers	Y	Y	N
	Allowing no others	Y	N	N
REWRITE	Allowing no others	Y	N	N
DELETE		Y	N	N
START	Allowing Updaters	Y	Y	N
	Allowing Readers	Y	Y	N
	Allowing no others	Y	Y	N
WRITE	Allowing no others	N/A	N/A	N/A

Legend: Y = Subsequent stream executes successful I-O operation  
 N = Subsequent stream I-O operation is unsuccessful (File Status 92)

Example 8–6 uses manual record locking. The file is opened with the ALLOWING ALL clause. The records are read but do not become available to other access streams because of the lock applied by the READ statement (READ...ALLOWING NO OTHERS). When the UNLOCK is executed, the records can be read by another access stream if that stream opens the file allowing writers.

#### **Example 8–6 Sample Program Using Manual Record Locking (HP Standard)**

```
FILE-CONTROL.
  SELECT FILE-1
    ORGANIZATION IS RELATIVE
    ASSIGN "SHAREDAT.DAT".
    .
    .
    .
  I-O-CONTROL.
    APPLY LOCK-HOLDING ON FILE-1.
```

(continued on next page)

## Sharing Files and Locking Records

### 8.4 Ensuring Successful Record Locking

#### Example 8–6 (Cont.) Sample Program Using Manual Record Locking (HP Standard)

```
.  
. .  
PROCEDURE DIVISION.  
BEGIN.  
    OPEN I-O FILE-1 ALLOWING ALL.  
    .  
    .  
    READ FILE-1 ALLOWING NO OTHERS AT END DISPLAY "end".  
    .  
    .  
    REWRITE FILE-1-REC ALLOWING NO OTHERS.  
    .  
    .  
    UNLOCK FILE-1 ALL RECORDS.  
    CLOSE FILE-1.  
    STOP RUN.
```

In manual record locking, you release record locks by the UNLOCK statement or when you close the file (either explicitly or implicitly; when you close a file, any existing record lock is released automatically). The UNLOCK statement provides for either releasing the lock on the current record (on OpenVMS systems with UNLOCK RECORD) or releasing all locks currently held by the access stream on the file (UNLOCK ALL RECORDS). (On Tru64 UNIX systems for indexed files only, there is no current record lock.)

When you access a shared file with ACCESS MODE IS SEQUENTIAL and use manual record locking, the UNLOCK statement can cause you to violate either of the following statements: (1) the REWRITE statement rule that states that the last input-output statement executed before the REWRITE must be a READ or START statement, or (2) the DELETE statement rule that states that the last input/output statement executed before the DELETE statement must be a READ. You must lock the record before it can be rewritten or deleted.

#### Releasing Locks on Deleted Records

In automatic record locking, the DELETE operation releases the lock on the record. In manual record-locking mode, you can delete a record using the DELETE statement but still retain a record lock. You must use the UNLOCK ALL RECORDS statement to release the lock on a deleted record.

If a second stream attempts to access a deleted record that retains a lock, the second stream will receive either a “record not found” exception or a hard lock condition. (See Section 8.4.3 for information on hard lock conditions.)

On OpenVMS, if another stream attempts to REWRITE a deleted record for which there is a retained lock, the type of exception that access stream receives depends on its file organization. If the file organization is RELATIVE, the access stream receives the “record locked” status. If the file organization is INDEXED, the access stream succeeds (receives the success status).

## Sharing Files and Locking Records

### 8.4 Ensuring Successful Record Locking

In relative files, the lock is on the relative cell (record) and cannot be rewritten until the lock is released. On indexed files, the lock is on the record's file address (RFA) of the deleted record, so a new record (with a new RFA) can be written to the file. ♦

#### Bypassing a Record Lock

When you use manual record locking, you can apply a READ REGARDLESS or START REGARDLESS statement to bypass any record lock that exists. READ REGARDLESS reads the record and applies no locks to the record. START REGARDLESS positions to the record and applies no locks to the record. If the record is currently locked by another access stream, a soft record lock condition can be detected by a USE procedure. (See Section 8.4.3 for information on soft record locks.)

You use READ REGARDLESS or START REGARDLESS when: (1) a record is locked against readers because the record is about to be written, but (2) your access program needs the existing record regardless of the possible change in its data.

---

#### Note

---

You should recognize that READ REGARDLESS and START REGARDLESS are of limited usefulness. They can only reliably tell the user whether a record exists with a given key value. They cannot guarantee the current contents of the data in the record. You prevent the use of READ REGARDLESS or START REGARDLESS at the file protection level when you prevent readers from referencing the file.

You can use READ REGARDLESS and START REGARDLESS during sequential file access to force the File Position Indicator.

---

When you close a file, any existing record lock is released automatically. The UNLOCK RECORD statement releases the lock only on the current record on OpenVMS systems, which is the last record you successfully accessed. On Tru64 UNIX systems for indexed files only, there is no current record lock.

#### 8.4.3 Error Handling for Record Locking

This section describes the locking error conditions and the two kinds of locks: hard and soft.

---

#### Note

---

Soft record locks are available for Hewlett-Packard standard record locking but are not part of X/Open standard (Alpha, I64). Soft record lock conditions also do not occur on the Tru64 UNIX system for indexed files.

---

Any record contention error results in an unsuccessful statement for which a USE procedure will be invoked. A "record-locked" condition results in an I/O status code of 92.

#### Interpreting Locking Error Conditions

Two record-locking conditions (hard and soft record lock) indicate whether a record was transferred to the record buffer. HP COBOL provides the success, failure, or informational status of an I/O operation in the file status variable.

## Sharing Files and Locking Records

### 8.4 Ensuring Successful Record Locking

#### Hard Record Locks

A hard record lock condition, which causes the file status variable to be set to 92, indicates that the record operation failed and the record was not transferred to the buffer. A hard record lock results from a scenario such as the one shown in the following steps, which uses HP standard manual record-locking mode:

1. Program A opens the file I-O ALLOWING ALL.
2. Program A reads a record ALLOWING NO OTHERS.
3. Program B opens the file I-O ALLOWING ALL.
4. Program B tries to access the same record as A.
5. Program B receives a hard record lock condition.
6. The record is *not* accessible to Program B.
7. Program B's File Status variable is set to 92.
8. Program B's USE procedure is invoked.
9. Program A continues.

The record was not available to Program B.

On Tru64 UNIX, for INDEXED files, READ with the ALLOWING UPDATERS clause as well as any START statement will not detect a locked record. *Potential* conflicts do not trigger a hard lock condition, only *actual* conflicts do. ♦

#### Soft Record Locks

Soft record locks can occur only with HP standard record locking. A soft record lock condition, which causes the file status variable to be set to 90, indicates that the record operation was successful, the record was transferred to the buffer, and a prior access stream holds a lock on that record. A soft record lock can be detected by a USE procedure. This condition occurs in either of the following two situations:

- When a record is accessed in a file that has been opened in INPUT mode, a soft record lock condition may occur if the record has been locked by a prior stream. This depends on the type of lock held by the first stream and requested by the subsequent stream.
- In the second situation, a stream attempts to access a record that has been locked by another stream. The second stream employs a READ REGARDLESS or START REGARDLESS statement (see Bypassing a Record Lock), which overrides the hard record lock and allows access to the record. The second stream successfully reads the record and receives a soft record lock. (The second stream cannot update the record.)

For example, a soft record lock results from a situation such as the following, which uses automatic record-locking mode:

1. Program A opens the file I-O ALLOWING READERS.
2. Program A reads a record.
3. Program B opens the file INPUT ALLOWING ALL.
4. Program B reads the same record.
5. Program B receives a soft record lock condition. The record is accessible to Program B.
6. Program B's File Status variable is set to 90.

## Sharing Files and Locking Records

### 8.4 Ensuring Successful Record Locking

7. On OpenVMS, Program B's USE procedure (if any) is invoked. ♦
8. Programs A and B continue.

The record was available to Program B.

---

#### Note

---

A file (and thus the records in it) cannot be shared if automatic or manual record locking is not specified by the user.

---

A manual record-locking environment is required in order for the REGARDLESS and ALLOWING options to be used on a READ statement. The READ REGARDLESS and START REGARDLESS statements should be used only when the access program clearly needs the existing record regardless of the possible imminent change in its data. For a full description of the OPEN, READ, and START statements and their options, refer to the *HP COBOL Reference Manual*.

#### Soft Record Locks and Declarative USE Procedures

If a soft record lock occurs, the values of the following variables for the current file are undefined until the execution of any applicable Declarative USE procedure is complete:

- Record buffer
- RELATIVE KEY
- DEPENDING ON

These variables remain undefined if the Declarative USE procedure terminates with an EXIT PROGRAM statement.

#### Hard Record Locks and File Position During Sequential Access

If a hard record lock condition occurs for a sequential READ statement, the file position indicator is unaffected. If the application must continue reading records, the following actions may be taken:

- HP standard record locking  
START or READ REGARDLESS may be used to bypass a hard record lock (see Soft Record Locks).
- X/Open standard record locking  
For indexed and relative files, a START statement, with the appropriate KEY clause, may be used to skip the record that is locked. On Alpha and I64, because X/Open START statements do not detect or acquire a record lock, some file processing may still be possible. However, users must be aware that this is not typical sequential file processing, as not all records will be retrieved.

#### Error Handling Example

Example 8-7 is an example of processing locked record conditions.

#### Example 8-7 Program Segment for Record-Locking Exceptions

(continued on next page)

## Sharing Files and Locking Records

### 8.4 Ensuring Successful Record Locking

#### Example 8-7 (Cont.) Program Segment for Record-Locking Exceptions

```
FILE-CONTROL.
    SELECT file-name ASSIGN TO "fshare.dat"
        FILE STATUS IS file-stat.

WORKING-STORAGE SECTION.
01  file-stat PIC XX.
    88 record-ok      VALUES "00", "02", "04".
    88 record-locked VALUE  "92".
01  RETRY-COUNT PIC 9(2).
01  MAX-RETRY   pic 9(2) VALUE 10.
    .
    .
    .
PROCEDURE DIVISION.
DECLARATIVES.
FILE-USE SECTION.  USE AFTER STANDARD EXCEPTION PROCEDURE ON file-name.
FILE-ERR.
* need declaratives to trap condition, but let main code process it.
* invalid key clause does not apply

        IF record-locked
            continue
        ELSE
            .
            .
            .
        END-IF.
END DECLARATIVES.
MAIN-BODY SECTION.
BEGIN.
    DISPLAY "From main-body".
    .
    .
    .
GET-RECORD.
    READ file-name.
    IF NOT record-ok
        PERFORM check-read.
    .
    .
    .
CHECK-READ.
    IF record-locked
        MOVE 1 to retry-count
        PERFORM retry-read UNTIL record-ok OR
            retry-count > max-retry
    IF record-locked AND retry-count > max-retry
        DISPLAY "Record is unavailable...enter new record to retrieve: "
            WITH NO ADVANCING
        ACCEPT record-id
        GO TO get-record
    END-IF
END-IF.

* handle other possible errors here

RETRY-READ.
    READ file-name.
    add 1 to retry-count.
```



---

## Using the SORT and MERGE Statements

This chapter includes the following information about using the SORT and MERGE statements to sort and merge records for sequential, line sequential (Alpha and I64 only), relative, and indexed files:

- Sorting data with the SORT statement (Section 9.1)
- Merging data with the MERGE statement (Section 9.2)
- Sample programs using the SORT and MERGE statements (Section 9.3)

### 9.1 Sorting Data with the SORT Statement

The SORT statement provides a wide range of sorting capabilities and options. To establish a SORT routine, you do the following:

1. Declare the sort file with an Environment Division SELECT statement.
2. Use a Data Division Sort Description (SD) entry to define the sort file's characteristics.
3. Use a Procedure Division SORT statement.

The following program segments demonstrate SORT program coding:

#### **SELECT Statement (Environment Division)**

```
SELECT SORT-FILE ASSIGN TO "SRTFIL"
```

#### **An SD File Description Entry (Data Division)**

```
SD SORT-FILE.
01 SORT-RECORD.
   05 SORT-KEY1   PIC X(5).
   05 SOME-DATA   PIC X(25).
   05 SORT-KEY2   PIC XX.
```

---

#### **Note**

---

You can place the sort file anywhere in the FILE SECTION, but you must use a Sort Description (SD) level indicator, not a File Description (FD) level indicator. Also, you cannot use the SD file for any other purpose in the COBOL program.

---

#### **SORT Statement (Procedure Division)**

```
SORT SORT-FILE
  ASCENDING KEY S-NAME
  USING NAME-FILE
  GIVING NEW-FILE.
```

The SORT statement names a sort file, sort keys, an input file, and an output file. An explanation of sort keys follows.

## Using the SORT and MERGE Statements

### 9.1 Sorting Data with the SORT Statement

#### Sorting Concepts

Records are sorted based on the data values in the sort keys. **Sort keys** identify the location of a record or the ordering of data. The following example depicts unsorted employee name and address records used for creating mailing labels:

Smith,	Joe	234 Ash St.	New Boston	NH	04356
Jones,	Bill	12 Birch St.	Gardner	MA	01430
Baker,	Tom	78 Oak St.	Ayer	MA	01510
Thomas,	Pete	555 Maple St.	Maynard	MA	01234
Morris,	Dick	21 Harris St.	Acton	ME	05670

If you sort the addresses in the previous example in ascending order using the zip code as the sort key, the mailing labels are printed in the order shown in the following example:

					<u>SORT KEY</u>
Thomas,	Pete	555 Maple St.	Maynard	MA	01234
Jones,	Bill	12 Birch St.	Gardner	MA	01430
Baker,	Tom	78 Oak St.	Ayer	MA	01510
Smith,	Joe	234 Ash St.	New Boston	NH	04356
Morris,	Dick	21 Harris St.	Acton	ME	05670

Also, records can be sorted on more than one key at a time. If you need an alphabetical listing of all employees within each state, you can sort on the state code first (major sort key) and employee name second (minor sort key).

For example, if you sort the file in ascending order by state and last name, the employee names and addresses appear in the order shown in the following example:

<u>SORT KEY</u>				<u>SORT KEY</u>	
<u>(minor)</u>				<u>(major)</u>	
Baker,	Tom	78 Oak St.	Ayer	MA	01510
Jones,	Bill	12 Birch St.	Gardner	MA	01430
Thomas,	Pete	555 Maple St.	Maynard	MA	01234
Morris,	Dick	21 Harris St.	Acton	ME	05670
Smith,	Joe	234 Ash St.	New Boston	NH	04356

#### 9.1.1 File Organization Considerations for Sorting

You can sort any file regardless of its organization; furthermore, the organization of the output file can differ from that of the input file. For example, a sort can have a sequential input file and a relative output file. In this case, the relative key for the first record returned from the sort is 1; the second record's relative key is 2; and so forth. However, if an indexed file is described as output in the GIVING or OUTPUT PROCEDURE phrases, the first sort key associated with the ASCENDING phrase must specify the same character positions specified by the RECORD KEY phrase for that file.

Sections 9.1.2, 9.1.3, and 9.1.4 describe the ASCENDING and DESCENDING KEY phrases, the USING and GIVING phrases, and the INPUT PROCEDURE and OUTPUT PROCEDURE phrases for sorting.

## Using the SORT and MERGE Statements

### 9.1 Sorting Data with the SORT Statement

#### 9.1.2 Specifying Sort Parameters with the ASCENDING and DESCENDING KEY Phrases

Use the Data Division ASCENDING and DESCENDING KEY phrases to specify your sort parameters. The order of data names determines the sort hierarchy; that is, the **major sort key** is the first data name entered, while the **minor sort key** is the last data name entered.

In the following example, the hierarchy of the sort is SORT-KEY-1, SORT-KEY-2, SORT-KEY-3.

```
SORT SORT-FILE
  ASCENDING KEY SORT-KEY-1 SORT-KEY-2
  DESCENDING KEY SORT-KEY-3
```

#### 9.1.3 Resequencing Files with the USING and GIVING Phrases

If you only need to resequence a file, use the USING and GIVING phrases of the SORT statement. The USING phrase opens the input file, then reads and releases its records to the sort. The GIVING phrase opens and writes sorted records to the output file.

Note that you cannot manipulate data with either the USING or the GIVING phrases.

Consider this SORT statement:

```
SORT SORT-FILE ON ASCENDING KEY SORT-KEY-1
  USING INPUT-FILE GIVING OUTPUT-FILE.
```

It does the following:

1. Opens INPUT-FILE
2. Reads all records in INPUT-FILE and releases them to the sort
3. Sorts the records in ascending sequence using the data in SORT-KEY-1
4. Opens the output file and writes the sorted records to OUTPUT-FILE
5. Closes all files used in the SORT statement

#### 9.1.4 Manipulating Data Before and After Sorting with the INPUT PROCEDURE and OUTPUT PROCEDURE Phrases

You can manipulate data before and after sorting by using the INPUT PROCEDURE and OUTPUT PROCEDURE phrases, and sort only some of the information in a file. For example, these phrases allow you to use only those input records and/or input data fields you need.

The INPUT PROCEDURE phrase replaces the USING phrase when you want to manipulate data entering the sort. The SORT statement transfers control to the sections or paragraphs named in the INPUT PROCEDURE phrase. You then use COBOL statements to open and read files, and manipulate the data. You use the RELEASE statement to transfer records to the sort. After the last statement of the input procedure executes, control is given to the sort, and the records are subsequently sorted.

After the records are sorted, the SORT statement transfers control to the sections or paragraphs named in the OUTPUT PROCEDURE phrase. This phrase replaces the GIVING phrase when you want to manipulate data in the sort. You can use COBOL statements to open files and manipulate data. You use the

## Using the SORT and MERGE Statements

### 9.1 Sorting Data with the SORT Statement

RETURN statement to transfer records from the sort. For example, you can use the RETURN statement to retrieve the sorted records for printing a report.

Example 9–1 shows a sample sort using the INPUT and OUTPUT procedures.

#### Example 9–1 INPUT and OUTPUT PROCEDURE Phrases

```
IDENTIFICATION DIVISION.
PROGRAM-ID. EX0901.
ENVIRONMENT DIVISION.
INPUT-OUTPUT SECTION.

FILE-CONTROL.
    SELECT INPUT-FILE    ASSIGN TO "input.dat".
    SELECT OUTPUT-FILE   ASSIGN TO "output.dat".
    SELECT SORT-FILE     ASSIGN TO "sort.dat".

DATA DIVISION.
FILE SECTION.
FD INPUT-FILE.
01 INPUT-RECORD        PIC X(100).
FD OUTPUT-FILE.
01 OUTPUT-RECORD      PIC X(100).
SD SORT-FILE.
01 SORT-RECORD        PIC X(100).
01 SORT-KEY-1         PIC XXX.
01 SORT-KEY-2         PIC XXX.

WORKING-STORAGE SECTION.

PROCEDURE DIVISION.
000-SORT SECTION.
010-DO-THE-SORT.
    SORT SORT-FILE ON ASCENDING KEY SORT-KEY-1
                  ON DESCENDING KEY SORT-KEY-2
                  INPUT PROCEDURE IS 050-RETRIEVE-INPUT
                  THRU 100-DONE-INPUT
                  OUTPUT PROCEDURE IS 200-WRITE-OUTPUT
                  THRU 230-DONE-OUTPUT.

    DISPLAY "END OF SORT".
    STOP RUN.
050-RETRIEVE-INPUT SECTION.
060-OPEN-INPUT.
    OPEN INPUT INPUT-FILE.
070-READ-INPUT.
    READ INPUT-FILE AT END
      CLOSE INPUT-FILE
      GO TO 100-DONE-INPUT.
    MOVE INPUT-RECORD TO SORT-RECORD.
```

(continued on next page)

## Using the SORT and MERGE Statements

### 9.1 Sorting Data with the SORT Statement

#### Example 9–1 (Cont.) INPUT and OUTPUT PROCEDURE Phrases

```
*****
* You can add, change, or delete records before sorting *
* using COBOL data manipulation *
* techniques. *
*****
      RELEASE SORT-RECORD.
      GO TO 070-READ-INPUT.
100-DONE-INPUT SECTION.
110-EXIT-INPUT.
      EXIT.
200-WRITE-OUTPUT SECTION.
210-OPEN-OUTPUT.
      OPEN OUTPUT OUTPUT-FILE.
220-GET-SORTED-RECORDS.
      RETURN SORT-FILE AT END
      CLOSE OUTPUT-FILE
      GO TO 230-DONE-OUTPUT.
      MOVE SORT-RECORD TO OUTPUT-RECORD.
*****
* You can add, change, or delete sorted records *
* using COBOL data manipulation *
* techniques. *
*****
      WRITE OUTPUT-RECORD.
      GO TO 220-GET-SORTED-RECORDS.
230-DONE-OUTPUT SECTION.
240-EXIT-OUTPUT.
      EXIT.
```

You can combine the INPUT PROCEDURE with the GIVING phrases, or the USING with the OUTPUT PROCEDURE phrases. In Example 9–2, the USING phrase replaces the INPUT PROCEDURE phrase used in Example 9–1.

---

#### Note

---

You cannot access records released to the sort-file after execution of the SORT statement ends.

---

## Using the SORT and MERGE Statements

### 9.1 Sorting Data with the SORT Statement

#### Example 9–2 USING Phrase Replaces INPUT PROCEDURE Phrase

```

.
.
.
PROCEDURE DIVISION.
000-SORT SECTION.
010-DO-THE-SORT.
    SORT SORT-FILE ON ASCENDING KEY SORT-KEY-1
                  ON DESCENDING KEY SORT-KEY-2
                  USING INPUT-FILE
                  OUTPUT PROCEDURE IS 200-WRITE-OUTPUT
                                      THRU 230-DONE-OUTPUT.

    DISPLAY "END OF SORT".
    STOP RUN.
200-WRITE-OUTPUT SECTION.
210-OPEN-OUTPUT.
    OPEN OUTPUT OUTPUT-FILE.
220-GET-SORTED-RECORDS.
    RETURN SORT-FILE AT END
    CLOSE OUTPUT-FILE
    GO TO 230-DONE-OUTPUT.
    MOVE SORT-RECORD TO OUTPUT-RECORD.
    WRITE OUTPUT-RECORD.
    GO TO 220-GET-SORTED-RECORDS.
230-DONE-OUTPUT SECTION.
240-EXIT-OUTPUT.
    EXIT.

```

#### 9.1.5 Maintaining the Input Order of Records Using the WITH DUPLICATES IN ORDER Phrase

The sort orders data in the sequence specified in the ASCENDING KEY and DESCENDING KEY phrases. However, records with duplicate sort keys may not be written to the output file in the same sequence as they were read into it. The WITH DUPLICATES IN ORDER phrase ensures that any records with duplicate sort keys are in the same order in the output file as in the input file.

The following list shows the potential difference between sorting with the WITH DUPLICATES IN ORDER phrase and sorting without it:

Input File		Sorted Without Duplicates in Order		Sorted With Duplicates in Order	
Name	Data	Name	Data	Name	Data
JONES	ABCD	DAVIS	LMNO	DAVIS	LMNO
DAVIS	LMNO	JONES	EFGH	JONES	ABCD
WHITE	STUV	JONES	ABCD	JONES	EFGH
JONES	EFGH	SMITH	1234	SMITH	1234
SMITH	1234	WHITE	STUV	WHITE	STUV
WHITE	WXYZ	WHITE	WXYZ	WHITE	WXYZ

If you omit the WITH DUPLICATES IN ORDER phrase, you cannot predict the order of records with duplicate sort keys. For example, the JONES records might not be in the same sequence as they were in the input file, but the WHITE records might be in the same order as in the input file.

## Using the SORT and MERGE Statements

### 9.1 Sorting Data with the SORT Statement

In contrast, the WITH DUPLICATES IN ORDER phrase guarantees that records with duplicate sort keys remain in the same sequence as they were in the input file.

#### 9.1.6 Specifying Non-ASCII Collating Sequences with the COLLATING SEQUENCE IS Alphabet-Name Phrase

This phrase lets you specify a collating sequence other than the ASCII default. You define collating sequences in the Environment Division SPECIAL-NAMES paragraph. A sequence specified in the COLLATING SEQUENCE IS phrase of the SORT statement overrides a sequence specified in the Environment Division PROGRAM COLLATING SEQUENCE IS phrase.

Example 9–3 shows the alphabet name NEWSEQUENCE overriding the EBCDIC-CODE collating sequence.

##### Example 9–3 Overriding the COLLATING SEQUENCE IS Phrase

```
ENVIRONMENT DIVISION.
OBJECT-COMPUTER.  FOO
    PROGRAM COLLATING SEQUENCE IS EBCDIC-CODE.
SPECIAL-NAMES.
    ALPHABET NEWSEQUENCE IS "ZYXWVUTSRQPONMLKJIHGFEDCBA"
    ALPHABET EBCDIC-CODE IS EBCDIC.
.
.
.
PROCEDURE DIVISION.
000-DO-THE-SORT.
    SORT SORT-FILE ON ASCENDING KEY
        SORT-KEY-1
        SORT-KEY-2
    COLLATING SEQUENCE IS NEWSEQUENCE
    USING INPUT-FILE GIVING OUTPUT-FILE.
```

#### 9.1.7 Multiple Sorting

A program can contain multiple sort files, multiple SORT statements, or both multiple sort files and multiple SORT statements. Example 9–4 uses two sort files to produce two reports with different sort sequences.

##### Example 9–4 Using Two Sort Files

```
.
.
.
DATA DIVISION.
FILE SECTION.
SD SORT-FILE1.
01 SORT-REC-1.
    03 S1-KEY-1      PIC X(5).
    03 FILLER       PIC X(40).
    03 S1-KEY-2     PIC X(5).
    03 FILLER       PIC X(50).
SD SORT-FILE2.
01 SORT-REC-2.
```

(continued on next page)

# Using the SORT and MERGE Statements

## 9.1 Sorting Data with the SORT Statement

### Example 9-4 (Cont.) Using Two Sort Files

```

01  SORT-REC-2.
    03  FILLER          PIC X(20).
    03  S2-KEY-1       PIC X(10).
    03  FILLER          PIC X(10).
    03  S2-KEY-2       PIC X(10).
    03  FILLER          PIC X(50).
      .
      .
      .
PROCEDURE DIVISION.
000-SORT SECTION.
010-DO-FIRST-SORT.
    SORT SORT-FILE1 ON ASCENDING KEY
                S1-KEY-1
                S1-KEY-2
                WITH DUPLICATES IN ORDER
                USING INPUT-FILE
                OUTPUT PROCEDURE IS 050-CREATE-REPORT-1
                                THRU 300-DONE-REPORT-1.

020-DO-SECOND-REPORT.
    SORT SORT-FILE2 ON ASCENDING KEY
                S2-KEY-1
                ON DESCENDING KEY
                S2-KEY-2
                USING INPUT-FILE
                OUTPUT PROCEDURE IS 400-CREATE-REPORT-2
                                THRU 700-DONE-REPORT-2.

030-END-JOB.
    DISPLAY "PROGRAM ENDED".
    STOP RUN.
050-CREATE-REPORT-1 SECTION.
*****
*
*
*   Use the RETURN statement to read the sorted records. *
*
*
*****
300-DONE-REPORT-1 SECTION.
310-EXIT-REPORT-1.
    EXIT.
400-CREATE-REPORT-2 SECTION.
*****
*
*
*   Use the RETURN statement to read the sorted records. *
*
*
*****
700-DONE-REPORT-2 SECTION.
710-EXIT-REPORT.
    EXIT.

```

### 9.1.8 Sorting Variable-Length Records

If you specify the USING phrase and the input file contains variable-length records, the sort-file record must not be smaller than the smallest record, nor larger than the largest record, described in the input file.



## Using the SORT and MERGE Statements

### 9.1 Sorting Data with the SORT Statement

If you specify the GIVING phrase and the output file contains variable-length records, the sort-file record must not be smaller than the smallest record, nor larger than the largest record, described in the output file.

#### 9.1.9 Preventing I/O Aborts

All I/O errors detected during a sort can cause abnormal program termination. The Declarative USE AFTER STANDARD ERROR PROCEDURE, shown in Example 9–5, specifies error-handling procedures should I/O errors occur.

##### Example 9–5 The Declarative USE AFTER STANDARD ERROR PROCEDURE

```
PROCEDURE DIVISION.  
DECLARATIVES.  
SORT-FILE SECTION.  
    USE AFTER STANDARD ERROR PROCEDURE ON INPUT-FILE.  
SORT-ERROR.  
    DISPLAY "I-O TYPE ERROR WHILE SORTING".  
    DISPLAY "INPUT-FILE STATUS IS " INPUT-STATUS.  
    STOP RUN.  
END DECLARATIVES.  
000-SORT SECTION.  
010-DO-THE-SORT.  
    SORT SORT-FILE ON DESCENDING KEY  
        S-KEY-1  
        WITH DUPLICATES IN ORDER  
        USING INPUT-FILE  
        GIVING OUTPUT-FILE.  
    DISPLAY "END OF SORT".  
    STOP RUN.
```

---

#### Note

---

The USE PROCEDURE phrase does not apply to Sort Description (SD) files.

---

#### 9.1.10 Sorting Tables (Alpha, I64)

The SORT statement can be used to order the elements in a table. This is especially useful for tables used with SEARCH ALL. The table elements are sorted based on the keys as specified in the OCCURS for the table unless you override them by specifying keys in the SORT statement. If no key is specified, the table elements are the SORT keys.

For the syntax and examples of table sorting, refer to the SORT statement description in the Procedure Division chapter of the *HP COBOL Reference Manual*. ♦

#### 9.1.11 Sorting at the Operating System Level

On OpenVMS an alternative to using the SORT statement within COBOL is to sort at the operating system level, using the bundled SORT utility, which you can access via the SORT, MERGE, and CONVERT DCL commands. ♦

## Using the SORT and MERGE Statements

### 9.1 Sorting Data with the SORT Statement

On Alpha and I64, you can choose between two sorting methods: Hypersort and SORT-32. (See Section 15.5.3 for more information on Hypersort and SORT-32.) SORT-32 is the default. Consult the DCL online help (type \$HELP SORT) for details about the two methods, which have effects on optimization and other differences, and information about how to switch between SORT-32 and Hypersort. If you select Hypersort at DCL level, it will be in effect for a SORT statement within a COBOL program as well. ♦

On Tru64 UNIX, Hypersort is the sole method available. ♦

On OpenVMS VAX, SORT-32 is the sole method available. ♦

See Appendix A for the record and key size limits with SORT-32 and Hypersort.

### 9.2 Merging Data with the MERGE Statement

The MERGE statement combines two or more identically sequenced files and makes their records available, in merged order, to an output procedure or to one or more output files. Use MERGE statement phrases the same way you use their SORT statement phrase equivalents. Note that the SORT phrases with DUPLICATES IN ORDER INPUT PROCEDURE are not allowed with MERGE.

In Example 9–6, district sales data is merged into one regional sales file.

#### Example 9–6 Using the MERGE Statement

```

      .
      .
      .
DATA DIVISION.
FILE SECTION.
SD  MERGE-FILE.
01  MERGE-REC.
      03  FILLER                PIC XX.
      03  M-PRODUCT-CODE        PIC X(10).
      03  FILLER                PIC X(88).
FD  DISTRICT1-SALES.
01  DISTRICT1-REC              PIC X(100).
FD  DISTRICT2-SALES.
01  DISTRICT2-REC              PIC X(100).
FD  REGION1-SALES.
01  REGION1-REC                PIC X(100).
PROCEDURE DIVISION.
000-MERGE-FILES.
      MERGE MERGE-FILE ON ASCENDING KEY M-PRODUCT-CODE
          USING DISTRICT1-SALES DISTRICT2-SALES
          GIVING REGION1-SALES.
      STOP RUN.
```

### 9.3 Sample Programs Using the SORT and MERGE Statements

The programs in Example 9–7, Example 9–8, Example 9–9, Example 9–10, Example 9–11, and Example 9–12 all show how to use the SORT and MERGE statements.

Example 9–7 shows how to use the SORT statement with the USING and GIVING phrases.

## Using the SORT and MERGE Statements

### 9.3 Sample Programs Using the SORT and MERGE Statements

#### Example 9–7 Sorting a File with the USING and GIVING Phrases

```
IDENTIFICATION DIVISION.
PROGRAM-ID.          SORTA.
*****
*   This program shows how to sort           *
*   a file with the USING and GIVING phrases *
*   of the SORT statement. The fields to be  *
*   sorted are S-KEY-1 and S-KEY-2; they     *
*   contain account numbers and amounts. The *
*   sort sequence is amount within account  *
*   number.                                  *
*   Notice that OUTPUT-FILE is a relative file.*
*****
ENVIRONMENT DIVISION.
CONFIGURATION SECTION.
INPUT-OUTPUT SECTION.
FILE-CONTROL.
    SELECT INPUT-FILE ASSIGN TO "INPFIL".
    SELECT OUTPUT-FILE ASSIGN TO "OUTFIL"
        ORGANIZATION IS RELATIVE.
    SELECT SORT-FILE ASSIGN TO "SRTFIL".
DATA DIVISION.
FILE SECTION.
SD  SORT-FILE.
01  SORT-REC.
    03  S-KEY-1.
        05  S-ACCOUNT-NUM      PIC X(8).
    03  FILLER                  PIC X(32).
    03  S-KEY-2.
        05  S-AMOUNT           PIC S9(5)V99.
    03  FILLER                  PIC X(53).
FD  INPUT-FILE
    LABEL RECORDS ARE STANDARD.
01  IN-REC                      PIC X(100).
FD  OUTPUT-FILE
    LABEL RECORDS ARE STANDARD.
01  OUT-REC                     PIC X(100).
PROCEDURE DIVISION.
000-DO-THE-SORT.
    SORT SORT-FILE ON ASCENDING KEY
        S-KEY-1
        S-KEY-2
    WITH DUPLICATES IN ORDER
    USING INPUT-FILE GIVING OUTPUT-FILE.

*****
*   At this point, you could transfer control to another *
*   section of your program and continue processing.     *
*****
    DISPLAY "END OF PROGRAM SORTA".
    STOP RUN.
```

Example 9–8 shows how to use the USING and OUTPUT PROCEDURE phrases.

## Using the SORT and MERGE Statements

### 9.3 Sample Programs Using the SORT and MERGE Statements

#### Example 9–8 Using the USING and OUTPUT PROCEDURE Phrases

```

IDENTIFICATION DIVISION.
PROGRAM-ID. SORTB.
*****
*   This program shows how to sort a file           *
*   with the USING and OUTPUT PROCEDURE phrases    *
*   of the SORT statement. The program eliminates  *
*   duplicate records by adding their amounts to the *
*   amount in the first record with the same account *
*   number. Only records with unique account numbers *
*   are written to the output file. The fields to be *
*   sorted are S-KEY-1 and S-KEY-2; they contain account *
*   numbers and amounts. The sort sequence is amount *
*   within account number.                         *
*   Notice that the organization of OUTPUT-FILE is indexed. *
*****
ENVIRONMENT DIVISION.
CONFIGURATION SECTION.
INPUT-OUTPUT SECTION.
FILE-CONTROL.
    SELECT INPUT-FILE ASSIGN TO "INPFIL".
    SELECT OUTPUT-FILE ASSIGN TO "OUTFIL"
        ORGANIZATION IS INDEXED.
    SELECT SORT-FILE ASSIGN TO "SRTFIL".
DATA DIVISION.
FILE SECTION.
SD SORT-FILE.
01 SORT-REC.
    03 S-KEY-1.
        05 S-ACCOUNT-NUM      PIC X(8).
    03 FILLER                  PIC X(32).
    03 S-KEY-2.
        05 S-AMOUNT           PIC S9(5)V99.
    03 FILLER                  PIC X(53).
FD INPUT-FILE
    LABEL RECORDS ARE STANDARD.
01 IN-REC                      PIC X(100).
FD OUTPUT-FILE
    LABEL RECORDS ARE STANDARD
    ACCESS MODE IS SEQUENTIAL
    RECORD KEY IS OUT-KEY.
01 OUT-REC.
    03 OUT-KEY                 PIC X(8).
    03 FILLER                  PIC X(92).
WORKING-STORAGE SECTION.
01 INITIAL-SORT-READ           PIC X   VALUE "Y".
01 SAVE-SORT-REC.
    03 SR-ACCOUNT-NUM         PIC X(8).
    03 FILLER                 PIC X(32).
    03 SR-AMOUNT              PIC S9(5)V99.
    03 FILLER                 PIC X(53).
PROCEDURE DIVISION.
000-START SECTION.
005-DO-THE-SORT.
    SORT SORT-FILE ON ASCENDING KEY
        S-KEY-1
        S-KEY-2

```

(continued on next page)

## Using the SORT and MERGE Statements

### 9.3 Sample Programs Using the SORT and MERGE Statements

#### Example 9–8 (Cont.) Using the USING and OUTPUT PROCEDURE Phrases

```
        USING INPUT-FILE
        OUTPUT PROCEDURE IS 300-CREATE-OUTPUT-FILE
                               THRU 600-DONE-CREATE.
*****
*   At this point, you could transfer control to another *
*   section of the program and continue processing.     *
*****
        DISPLAY "END OF PROGRAM SORTB".
        STOP RUN.

300-CREATE-OUTPUT-FILE SECTION.
350-OPEN-OUTPUT.
    OPEN OUTPUT OUTPUT-FILE.
400-READ-SORT-FILE.
    RETURN SORT-FILE AT END
        PERFORM 500-WRITE-THE-OUTPUT
        CLOSE OUTPUT-FILE
        GO TO 600-DONE-CREATE.
    IF INITIAL-SORT-READ = "Y"
        MOVE SORT-REC TO SAVE-SORT-REC
        MOVE "N" TO INITIAL-SORT-READ
        GO TO 400-READ-SORT-FILE.
450-COMPARE-ACCOUNT-NUM.
    IF S-ACCOUNT-NUM = SR-ACCOUNT-NUM
        ADD S-AMOUNT TO SR-AMOUNT
        GO TO 400-READ-SORT-FILE.
500-WRITE-THE-OUTPUT.
    MOVE SAVE-SORT-REC TO OUT-REC.
    WRITE OUT-REC INVALID KEY
        DISPLAY "INVALID KEY " SR-ACCOUNT-NUM " SORTB ABORTED"
        CLOSE OUTPUT-FILE STOP RUN.
550-GET-A-REC.
    MOVE SORT-REC TO SAVE-SORT-REC.
    GO TO 400-READ-SORT-FILE.
600-DONE-CREATE SECTION.
650-EXIT-PARAGRAPH.
    EXIT.
```

Example 9–9 shows how to use the INPUT PROCEDURE and OUTPUT PROCEDURE phrases.

## Using the SORT and MERGE Statements

### 9.3 Sample Programs Using the SORT and MERGE Statements

#### Example 9–9 Using the INPUT PROCEDURE and OUTPUT PROCEDURE Phrases

```

IDENTIFICATION DIVISION.
PROGRAM-ID. SORTC.
*****
*   This program shows how to use the INPUT           *
*   PROCEDURE and OUTPUT PROCEDURE phrases of the   *
*   SORT statement. Input to the sort is two files  *
*   containing the same type of data. Records with  *
*   a "D" status-code are not released to the sort. *
*   The program eliminates duplicate records by     *
*   adding their amounts to the amount in the first *
*   record with the same account number. Only records *
*   with unique account numbers are written to     *
*   the output file. The fields to be sorted are   *
*   S-KEY-1 and S-KEY-2. The sort sequence is amount *
*   within account number.                          *
*****
ENVIRONMENT DIVISION.
CONFIGURATION SECTION.
INPUT-OUTPUT SECTION.
FILE-CONTROL.
    SELECT FIRST-FILE ASSIGN TO "FILE01".
    SELECT SECOND-FILE ASSIGN TO "FILE02".
    SELECT OUTPUT-FILE ASSIGN TO "OUTFIL".
    SELECT SORT-FILE ASSIGN TO "SRTFIL".
DATA DIVISION.
FILE SECTION.
SD SORT-FILE.
01 SORT-REC.
    03 S-KEY-1.
        05 S-ACCOUNT-NUM      PIC X(8).
    03 FILLER                  PIC X(32).
    03 S-KEY-2.
        05 S-AMOUNT           PIC S9(5)V99.
    03 FILLER                  PIC X(53).
FD FIRST-FILE
LABEL RECORDS ARE STANDARD.
01 RECORD1.
    03 FILLER                  PIC X(99).
    03 R1-STATUS-CODE         PIC X.
FD SECOND-FILE
LABEL RECORDS ARE STANDARD.
01 RECORD2.
    03 FILLER                  PIC X(99).
    03 R2-STATUS-CODE         PIC X.
FD OUTPUT-FILE
LABEL RECORDS ARE STANDARD.
01 OUT-REC                    PIC X(100).
WORKING-STORAGE SECTION.
01 INITIAL-SORT-READ          PIC X   VALUE "Y".
01 FILE01-COUNT               PIC 9(5) VALUE ZEROES.
01 FILE02-COUNT               PIC 9(5) VALUE ZEROES.
01 SORT-COUNT                 PIC 9(5) VALUE ZEROES.
01 OUTPUT-COUNT               PIC 9(5) VALUE ZEROES.
01 SAVE-SORT-REC.
    03 SR-ACCOUNT-NUM         PIC X(8).
    03 FILLER                 PIC X(32).
    03 SR-AMOUNT              PIC S9(5)V99.
    03 FILLER                 PIC X(53).

```

(continued on next page)

## Using the SORT and MERGE Statements

### 9.3 Sample Programs Using the SORT and MERGE Statements

#### Example 9-9 (Cont.) Using the INPUT PROCEDURE and OUTPUT PROCEDURE Phrases

```
PROCEDURE DIVISION.
000-START SECTION.
005-DO-THE-SORT.
    SORT SORT-FILE ON ASCENDING KEY
        S-KEY-1
        S-KEY-2
    INPUT PROCEDURE IS 010-GET-INPUT
        THRU 200-DONE-INPUT-GET
    OUTPUT PROCEDURE IS 300-CREATE-OUTPUT-FILE
        THRU 600-DONE-CREATE.
*****
*   Notice the use of DISPLAY and record counters to   *
*   produce sort statistics.                           *
*****
    DISPLAY "TOTAL FIRST-FILE RECORDS IS              " FILE01-COUNT.
    DISPLAY "TOTAL SECOND-FILE RECORDS IS             " FILE02-COUNT.
    DISPLAY "TOTAL NUMBER OF SORTED RECORDS IS        " SORT-COUNT.
    DISPLAY "TOTAL NUMBER OF OUTPUT RECORDS IS        " OUTPUT-COUNT.
*****
*   At this point, you could transfer control to another *
*   section of the program and continue processing.     *
*****
    DISPLAY "END OF PROGRAM SORTC".
    STOP RUN.
010-GET-INPUT SECTION.
050-OPEN-FILES.
    OPEN INPUT FIRST-FILE.
100-READ-FIRST-FILE.
    READ FIRST-FILE AT END
    CLOSE FIRST-FILE
    OPEN INPUT SECOND-FILE
    GO TO 150-READ-SECOND-FILE.
    ADD 1 TO FILE01-COUNT.
    IF R1-STATUS-CODE = "D"
        GO TO 100-READ-FIRST-FILE.
    RELEASE SORT-REC FROM RECORD1.
    GO TO 100-READ-FIRST-FILE.
150-READ-SECOND-FILE.
    READ SECOND-FILE AT END
    CLOSE SECOND-FILE
    GO TO 200-DONE-INPUT-GET.
    ADD 1 TO FILE02-COUNT.
    IF R2-STATUS-CODE = "D"
        GO TO 150-READ-SECOND-FILE.
    RELEASE SORT-REC FROM RECORD2.
    GO TO 150-READ-SECOND-FILE.
200-DONE-INPUT-GET SECTION.
250-EXIT-PARAGRAPH.
    EXIT.
300-CREATE-OUTPUT-FILE SECTION.
350-OPEN-OUTPUT.
    OPEN OUTPUT OUTPUT-FILE.
400-READ-SORT-FILE.
    RETURN SORT-FILE AT END
    PERFORM 500-WRITE-THE-OUTPUT
    CLOSE OUTPUT-FILE
    GO TO 600-DONE-CREATE.
    ADD 1 TO SORT-COUNT.
    IF INITIAL-SORT-READ = "Y"
        MOVE SORT-REC TO SAVE-SORT-REC
```

(continued on next page)

## Using the SORT and MERGE Statements

### 9.3 Sample Programs Using the SORT and MERGE Statements

#### Example 9–9 (Cont.) Using the INPUT PROCEDURE and OUTPUT PROCEDURE Phrases

```

        MOVE "N" TO INITIAL-SORT-READ
        GO TO 400-READ-SORT-FILE.
450-COMPARE-ACCOUNT-NUM.
        IF S-ACCOUNT-NUM = SR-ACCOUNT-NUM
            ADD S-AMOUNT TO SR-AMOUNT
            GO TO 400-READ-SORT-FILE.
500-WRITE-THE-OUTPUT.
        MOVE SAVE-SORT-REC TO OUT-REC.
        WRITE OUT-REC.
        ADD 1 TO OUTPUT-COUNT.
550-GET-A-REC.
        MOVE SORT-REC TO SAVE-SORT-REC.
        GO TO 400-READ-SORT-FILE.
600-DONE-CREATE SECTION.
650-EXIT-PARAGRAPH.
        EXIT.

```

Example 9–10 shows how to use the COLLATING SEQUENCE IS phrase.

#### Example 9–10 Using the COLLATING SEQUENCE IS Phrase

```

IDENTIFICATION DIVISION.
PROGRAM-ID. SORTD.
*****
*   This program sorts a file into a non-ASCII   *
*   collating sequence. The collating sequence  *
*   is defined by the alphabet-name MYSEQUENCE  *
*   in the SPECIAL-NAMES paragraph of the       *
*   ENVIRONMENT DIVISION.                       *
*   The collating sequence is:                   *
*       1. The letters A to Z                     *
*       2. The digits 0 to 9                       *
*****
ENVIRONMENT DIVISION.
CONFIGURATION SECTION.
SPECIAL-NAMES.
        ALPHABET MYSEQUENCE IS
            "ABCDEFGHJKLMNPOQRSTUVWXYZ0123456789 ".
INPUT-OUTPUT SECTION.
FILE-CONTROL.
        SELECT INPUT-FILE ASSIGN TO "INPFIL".
        SELECT OUTPUT-FILE ASSIGN TO "OUTFIL".
        SELECT SORT-FILE ASSIGN TO "SRTFIL".
DATA DIVISION.
FILE SECTION.
SD SORT-FILE.
01 SORT-REC.
    03 S-KEY-1.
        05 S-ACCOUNT-NAME      PIC X(23).
    03 S-KEY-2.
        05 S-AMOUNT            PIC S9(5)V99.

```

(continued on next page)



## Using the SORT and MERGE Statements

### 9.3 Sample Programs Using the SORT and MERGE Statements

#### Example 9–10 (Cont.) Using the COLLATING SEQUENCE IS Phrase

```
FD INPUT-FILE
  LABEL RECORDS ARE STANDARD.
01 IN-REC          PIC X(30).
FD OUTPUT-FILE
  LABEL RECORDS ARE STANDARD.
01 OUT-REC        PIC X(30).
PROCEDURE DIVISION.
000-DO-THE-SORT.
  SORT SORT-FILE ON ASCENDING KEY
    S-KEY-1
    S-KEY-2
  COLLATING SEQUENCE IS MYSEQUENCE
  USING INPUT-FILE GIVING OUTPUT-FILE.
*****
*   At this point, you could transfer control to another   *
*   section of the program and continue processing.       *
*****
  DISPLAY "END OF PROGRAM SORTD".
  STOP RUN.
```

Example 9–11 is an example of creating a new sort key.

#### Example 9–11 Creating a New Sort Key

```
IDENTIFICATION DIVISION.
PROGRAM-ID.  SORTD.
*****
*   This program increases the size of the                 *
*   variable input records by a new six-                  *
*   character field and uses this field                    *
*   as the sort key.                                       *
*****
ENVIRONMENT DIVISION.
CONFIGURATION SECTION.
INPUT-OUTPUT SECTION.
FILE-CONTROL.
  SELECT INFILE ASSIGN TO "INFILE".
  SELECT SORT-FILE ASSIGN TO "SRTFIL".
  SELECT OUT-FILE ASSIGN TO "OUTFILE".
DATA DIVISION.
FILE SECTION.
FD      INFILE
  RECORD VARYING FROM 100 TO 490 CHARACTERS
  DEPENDING ON IN-LENGTH.
01      INREC.
  03 ACCOUNT          PIC 9(5).
  03 INCOME-FIRST-QUARTER PIC 9(5)V99.
  03 INCOME-SECOND-QUARTER PIC 9(5)V99.
  03 INCOME-THIRD-QUARTER PIC 9(5)V99.
```

(continued on next page)

## Using the SORT and MERGE Statements

### 9.3 Sample Programs Using the SORT and MERGE Statements

#### Example 9–11 (Cont.) Creating a New Sort Key

```
      03 INCOME-FOURTH-QUARTER  PIC 9(5)V99.
      03 ORDER-COUNT            PIC 9(2).
      03 ORDERS OCCURS 1 TO 7 TIMES
          DEPENDING ON ORDER-COUNT.
          05 ORDER-DATE         PIC 9(6).
          05 FILLER             PIC X(59).
SD    SORT-FILE
      RECORD VARYING FROM 106 TO 496 CHARACTERS
      DEPENDING ON SORT-LENGTH.
01    SORT-REC.
      03 SORT-ANNUAL-INCOME     PIC 9(6).
      03 SORT-REST-OF-RECORD    PIC X(490).
FD    OUT-FILE
      RECORD VARYING FROM 106 TO 496 CHARACTERS
      DEPENDING ON OUT-LENGTH.
01    OUT-REC                   PIC X(496).
WORKING-STORAGE SECTION.
01    IN-LENGTH                 PIC 9(3) COMP.
01    SORT-LENGTH               PIC 9(3) COMP.
01    OUT-LENGTH                PIC 9(3) COMP.
PROCEDURE DIVISION.
000-START SECTION.
005-SORT-HERE.
      SORT SORT-FILE
          ON DESCENDING SORT-ANNUAL-INCOME
          INPUT PROCEDURE 010-GET-INPUT
              THRU 070-DONE-INPUT
          OUTPUT PROCEDURE 100-WRITE-OUTPUT.
      DISPLAY "END OF PROGRAM SORTE".
      STOP RUN.
010-GET-INPUT SECTION.
020-OPEN-INPUT.
      OPEN INPUT INFILE.
030-READ-INPUT.
      READ INFILE AT END
          CLOSE INFILE
          GO TO 070-DONE-INPUT.
040-ADD-INCOME.
      ADD INCOME-FIRST-QUARTER
          INCOME-SECOND-QUARTER
          INCOME-THIRD-QUARTER
          INCOME-FOURTH-QUARTER
          GIVING SORT-ANNUAL-INCOME.
050-CREATE-SORT-REC.
      ADD 6 IN-LENGTH GIVING SORT-LENGTH.
      MOVE INREC TO SORT-REST-OF-RECORD.
      RELEASE SORT-REC.
      GO TO 030-READ-INPUT.
070-DONE-INPUT SECTION.
080-EXIT.
      EXIT.
100-WRITE-OUTPUT SECTION.
110-OPEN.
      OPEN OUTPUT OUT-FILE.
```

(continued on next page)

## Using the SORT and MERGE Statements

### 9.3 Sample Programs Using the SORT and MERGE Statements

#### Example 9–11 (Cont.) Creating a New Sort Key

```
120-WRITE.  
    RETURN SORT-FILE AT END  
    CLOSE OUT-FILE  
    GO TO 130-DONE.  
    MOVE SORT-LENGTH TO OUT-LENGTH.  
    WRITE OUT-REC.  
    GO TO 120-WRITE.  
130-DONE.  
    EXIT.
```

Example 9–12 merges three identically sequenced files into one file.

#### Example 9–12 Merging Files

```
IDENTIFICATION DIVISION.  
PROGRAM-ID.    MERGE01.  
*****  
* This program merges three identically sequenced *  
* regional sales files into one total sales file. *  
* The program adds sales amounts and writes one *  
* record for each product code. *  
*****  
ENVIRONMENT DIVISION.  
CONFIGURATION SECTION.  
INPUT-OUTPUT SECTION.  
FILE-CONTROL.  
    SELECT REGION1-SALES ASSIGN TO "REG1SLS".  
    SELECT REGION2-SALES ASSIGN TO "REG2SLS".  
    SELECT REGION3-SALES ASSIGN TO "REG3SLS".  
    SELECT MERGE-FILE  ASSIGN TO "MRGFILE".  
    SELECT TOTAL-SALES  ASSIGN TO "TOTLSLS".  
DATA DIVISION.  
FILE SECTION.  
FD  REGION1-SALES  
    LABEL RECORDS ARE STANDARD.  
01  REGION1-RECORD          PIC X(100).  
FD  REGION2-SALES  
    LABEL RECORDS ARE STANDARD.  
01  REGION2-RECORD          PIC X(100).  
FD  REGION3-SALES  
    LABEL RECORDS ARE STANDARD.  
01  REGION3-RECORD          PIC X(100).  
SD  MERGE-FILE.  
01  MERGE-REC.  
    03  M-REGION-CODE        PIC XX.  
    03  M-PRODUCT-CODE      PIC X(10).  
    03  M-SALES-AMT          PIC S9(7)V99.  
    03  FILLER                PIC X(79).
```

(continued on next page)

## Using the SORT and MERGE Statements

### 9.3 Sample Programs Using the SORT and MERGE Statements

#### Example 9–12 (Cont.) Merging Files

```
FD TOTAL-SALES
  LABEL RECORDS ARE STANDARD.
01 TOTAL-RECORD          PIC X(100).
WORKING-STORAGE SECTION.
01 INITIAL-READ          PIC X VALUE "Y".
01 THE-COUNTERS.
   03 PRODUCT-AMT        PIC S9(7)V99.
   03 REGION1-AMT        PIC S9(9)V99.
   03 REGION2-AMT        PIC S9(9)V99.
   03 REGION3-AMT        PIC S9(9)V99.
   03 TOTAL-AMT          PIC S9(11)V99.
01 SAVE-MERGE-REC.
   03 S-REGION-CODE      PIC XX.
   03 S-PRODUCT-CODE     PIC X(10).
   03 S-SALES-AMT        PIC S9(7)V99.
   03 FILLER              PIC X(79).
PROCEDURE DIVISION.
000-START SECTION.
010-MERGE-FILES.
  OPEN OUTPUT TOTAL-SALES.
  MERGE MERGE-FILE ON ASCENDING KEY M-PRODUCT-CODE
    USING REGION1-SALES REGION2-SALES REGION3-SALES
    OUTPUT PROCEDURE IS 020-BUILD-TOTAL-SALES
    THRU 100-DONE-TOTAL-SALES.
  DISPLAY "TOTAL SALES FOR REGION 1 " REGION1-AMT.
  DISPLAY "TOTAL SALES FOR REGION 2 " REGION2-AMT.
  DISPLAY "TOTAL SALES FOR REGION 3 " REGION3-AMT.
  DISPLAY "TOTAL ALL SALES          " TOTAL-AMT.
  CLOSE TOTAL-SALES.
  DISPLAY "END OF PROGRAM MERGE01".
  STOP RUN.
020-BUILD-TOTAL-SALES SECTION.
030-GET-MERGE-RECORDS.
  RETURN MERGE-FILE AT END
    MOVE PRODUCT-AMT TO S-SALES-AMT
    WRITE TOTAL-RECORD FROM SAVE-MERGE-REC
    GO TO 100-DONE-TOTAL-SALES.
  IF INITIAL-READ = "Y"
    MOVE "N" TO INITIAL-READ
    MOVE MERGE-REC TO SAVE-MERGE-REC
    PERFORM 050-TALLY-AMOUNTS
    GO TO 030-GET-MERGE-RECORDS.
040-COMPARE-PRODUCT-CODE.
  IF M-PRODUCT-CODE = S-PRODUCT-CODE
    PERFORM 050-TALLY-AMOUNTS
    GO TO 030-GET-MERGE-RECORDS.
  MOVE PRODUCT-AMT TO S-SALES-AMT.
  MOVE ZEROES TO PRODUCT-AMT.
  WRITE TOTAL-RECORD FROM SAVE-MERGE-REC.
  MOVE MERGE-REC TO SAVE-MERGE-REC.
  GO TO 040-COMPARE-PRODUCT-CODE.
```

(continued on next page)

## Using the SORT and MERGE Statements

### 9.3 Sample Programs Using the SORT and MERGE Statements

#### Example 9–12 (Cont.) Merging Files

```
050-TALLY-AMOUNTS.  
  ADD M-SALES-AMT TO PRODUCT-AMT TOTAL-AMT.  
  IF M-REGION-CODE = "01"  
    ADD M-SALES-AMT TO REGION1-AMT.  
  IF M-REGION-CODE = "02"  
    ADD M-SALES-AMT TO REGION2-AMT.  
  IF M-REGION-CODE = "03"  
    ADD M-SALES-AMT TO REGION3-AMT.  
100-DONE-TOTAL-SALES SECTION.  
120-DONE.  
  EXIT.
```



---

## Producing Printed Reports

There are three Hewlett-Packard COBOL programming capabilities for producing formatted reports: conventional, lineage file, and Report Writer. This chapter presents the following topics to help you format and produce reports:

- Designing a report (Section 10.1)
- Components of a report (Section 10.2)
- Methods of reporting accumulation and control totals (Section 10.3)
- The logical page and the physical page (Section 10.4)
- Programming a conventional file report (Section 10.5)
- Programming a lineage-file HP COBOL report (Section 10.6)
- Modes for printing reports (Section 10.7)
- Programming a Report Writer report (Section 10.8)
- Report Writer examples (Section 10.9)
- Solving report problems (Section 10.10)

### 10.1 Designing a Report

The design of a report is dictated by the data you must include in the report. If you have a general idea of what the report is to contain, you can produce a rough outline using a report layout worksheet.

To create the worksheet, either use an online text editor or draw a layout worksheet like the one displayed in Figure 10–1.

The layout worksheet in Figure 10–1 has 132 characters on a line and 60 lines on a page. When you outline your worksheet, include specifics such as page headings, rows and columns, and column sizes.

Section 10.2 describes other report components that you must plan for when you design a report. Note that you can use your worksheet later when you write the HP COBOL program that produces the report.

### 10.2 Components of a Report

There are seven components of a report. Example 10–1 illustrates them.







## Producing Printed Reports

### 10.2 Components of a Report

- ③ Control Heading (CH)—The control heading consists of one or more lines of information identifying the beginning of a new logical area on a page.
- ④ Detail Lines (DL)—The detail (the lines marked with 4 and all the lines between) consists of one or more lines of the primary data of the report.
- ⑤ Control Footing (CF)—The control footing (the line marked with 5 and the following line) consists of one or more lines of information identifying the end of a logical area. The control footing can contain one or more totals and an accompanying message.
- ⑥ Page Footing (PF)—The page footing (the lines marked with 6 and all the lines between) consists of one or more lines of information at the bottom of each page.
- ⑦ Report Footing (RF)—The report footing (the lines marked with 7 and all the lines between) consists of information printed after the main body of the report. It can be continued on the same page of the report body, or it can be on a separate page. It may contain information such as hash or control totals. A report footing is a convenient place to print run-time statistics, such as the number of records read and written for each file. It can also provide warning messages, such as when a table is close to overflowing.

It is suggested that all reports have an END OF REPORT message or other indicator at the end of the report, so that you can tell at a glance that you have all the pages. (The consecutive page numbers tell if a page is missing, but they do not indicate which page is the last.)

### 10.3 Accumulating and Reporting Totals

Your program can report three types of totals in the control footings and report footings of your report:

- Subtotals—Subtotaling is the process of summing a detail item from each detail line. For example, in Figure 10–2, Salary, Bonus, and Total Sales are subtotaled. To get the first salary subtotal for January on page 1 (\$75,000.00), the program must add each salesman’s salary (\$30,000+\$25,000+\$20,000). After printing the salary total, the program must zero the total to begin subtotaling for the next month.
- Crossfoot Totals—Crossfooting is the process of summing subtotals from a common group of totals. For example, in Figure 10–2, TOTAL SALARY EXPENSE is crossfooted by adding TOTAL SALARY and TOTAL BONUS. To get the first TOTAL SALARY EXPENSE crossfoot total for the January report, the program must add the salary subtotal and the bonus subtotal before the program clears the subtotals.
- Rolled Forward Totals—Rolling-forward is the process of summing either subtotals or crossfoot totals. For example, in Figure 10–2, the YEAR TO DATE TOTALS at the bottom of page 1 are rolled forward from both the JANUARY and FEBRUARY totals. The program computes the salary and bonus YEAR TO DATE TOTALS from the previous salary and bonus subtotals. It computes the total salary expense figure from the previous total salary expense crossfoot totals.

## Producing Printed Reports 10.4 The Logical Page and the Physical Page

**Figure 10–2 Subtotals, Crossfoot Totals, and Rolled Forward Totals**

04-NOVEMBER-96	Year To Date Sales Report		Page 1
Salesman     Salary/Bonus	Client Name	Client Address	Total Sales
***** JANUARY REPORT *****			
SMITH             \$30,000.00	STREN	2742 NORTH ST.	\$225,000.00
JOHN              \$10,000.00	TOM	MANCHESTER, NH	
LEPRO             \$25,000.00	FOSTER	967 HOOVER LANE	\$195,000.00
RONALD           \$10,000.00	FRANK	CAMBRIDGE, MA	
BALLET            \$20,000.00	O'BRIEN	1001 HUGE DRIVE	\$ 15,000.00
FRANCES          \$10,000.00	PAUL	MT. SNOW, VT	
-----			
JANUARY TOTALS			
SALARY	\$ 75,000.00	← Salary subtotal	
BONUS	\$ 30,000.00	← Bonus subtotal	
-----			
TOTAL SALARY EXPENSE	\$105,000.00	← Crossfoot total (salary + bonus)	
TOTAL SALES		Subtotal →	\$435,000.00
***** FEBRUARY REPORT *****			
SMITH             \$30,000.00	STREN	2742 NORTH ST.	\$225,000.00
JOHN              \$10,000.00	TOM	MANCHESTER, NH	
LEPRO             \$25,000.00	FOSTER	967 HOOVER LANE	\$195,000.00
RONALD           \$10,000.00	FRANK	CAMBRIDGE, MA	
BALLET            \$20,000.00	O'BRIEN	1001 HUGE DRIVE	\$ 15,000.00
FRANCES          \$10,000.00	PAUL	MT. SNOW, VT	
-----			
FEBRUARY TOTALS			
SALARY	\$ 75,000.00	← Salary subtotal	
BONUS	\$ 30,000.00	← Bonus subtotal	
-----			
TOTAL SALARY EXPENSE	\$105,000.00	← Crossfoot total (salary + bonus)	
TOTAL SALES		Subtotal →	\$435,000.00
***** YEAR TO DATE TOTALS *****			
SALARY	\$150,000.00	← Salary rolled forward total	
BONUS	\$ 60,000.00	← Bonus rolled forward total	
-----			
TOTAL SALARY EXPENSE	\$210,000.00	← Crossfoot total (salary + bonus)	
TOTAL SALES		Rolled forward total →	\$870,000.00
-----			
----- COMPANY CONFIDENTIAL -----			
----- COMPANY CONFIDENTIAL -----			
----- COMPANY CONFIDENTIAL -----			

ZK-6080-GE

## 10.4 The Logical Page and the Physical Page

A physical page is the paper page printed by your printer.

A logical page is conceptual, consisting of a page body and optionally a top margin, footing, and bottom margin. Figure 10–3 and Figure 10–6 illustrate the logical page structure for the conventional file report and lineage file report, respectively.

The number of lines on a logical page is defined by the number of lines on the target physical page. Thus, the number of lines determines the size of the logical page. When you design a report, you must choose those lines within the logical page that are to be page headers (PH), control headers (CH), detail lines (DL), control footings (CF), and page footings (PF). Once the framework of the logical

## Producing Printed Reports

### 10.4 The Logical Page and the Physical Page

page is defined, your program must stay within those bounds; otherwise, the printed report may not contain the correct information.

You can program two types of reports: a conventional file report or a lineage file report. Section 10.5 and Section 10.5.1 discuss these reports in detail.

### 10.5 Programming a Conventional File Report

A conventional file report is contained in a file that has sequential organization and access mode, and that contains variable-length with fixed control records. This type of report consists of one or more logical pages. The program that produces the report uses ordinary syntax for writing sequential files, for example, OPEN, WRITE...AFTER ADVANCING, and CLOSE statements. The conventional report does not use lineage or Report Writer facilities.

To program a conventional report, you should understand how to do the following:

- Define the logical page.
- Advance to the next logical page.
- Program for the page-overflow condition.
- Use a line counter.

The following sections discuss these topics in detail. Additionally, Section 10.5.5 contains an example of an HP COBOL program that produces a conventional file report.

#### 10.5.1 Defining the Logical Page in a Conventional Report

Your program specifies the format of your report. Using the report layout worksheet you created, you can write an HP COBOL program that defines the logical page area for a conventional report. Figure 10–3 shows the logical page area for a conventional report. The conventional report logical page area consists of the page areas discussed in Section 10.4.

**Figure 10–3 Logical Page Area for a Conventional Report**

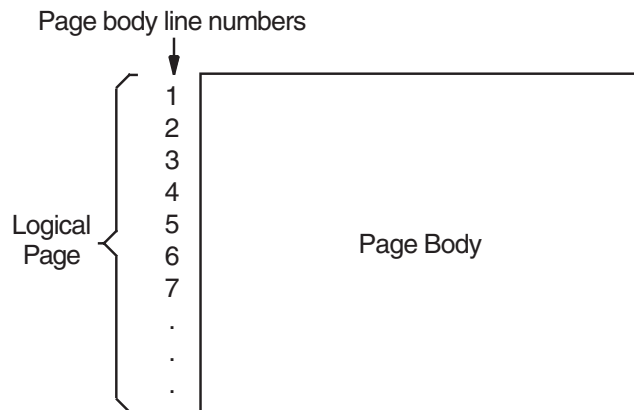

ZK-6081-GE

## Producing Printed Reports

### 10.5 Programming a Conventional File Report

Once you have defined the logical page, you must handle vertical spacing, horizontal spacing, and the number of lines that appear on each page so that you can advance to the next logical page. The following sections discuss these subjects.

#### 10.5.2 Controlling the Spacing in a Conventional Report

To control the horizontal spacing on a logical page, define every report item from your report layout worksheet in the Working-Storage Section of your HP COBOL program.

To control the vertical spacing on a logical page, use the `WRITE` statement. The `WRITE` statement controls whether one or more lines are skipped before or after your program writes a line of the report. For example, to print a line before advancing five lines, use the following:

```
WRITE... BEFORE ADVANCING 5 LINES.
```

To print a line after advancing two lines, use the following:

```
WRITE... AFTER ADVANCING 2 LINES.
```

#### 10.5.3 Advancing to the Next Logical Page in a Conventional Report

To advance to the next logical page and position the printer to the page heading area, you must be able to track the number of lines that your program writes on a page. The HP COBOL compiler lets you control the number of lines written on a page with the `WRITE` statement.

The `WRITE` statement must appear in your Procedure Division and it should contain either the `AFTER ADVANCING PAGE` or `BEFORE ADVANCING PAGE` clause. Example 10–3 demonstrates the use of the `WRITE` statement with the `AFTER ADVANCING PAGE` clause.

The next two sections discuss how to handle a page-overflow condition and how to use a line counter to keep track of the number of lines your program writes on a logical page.

##### 10.5.3.1 Programming for the Page-Overflow Condition in a Conventional Report

A page-overflow condition occurs when your program writes more lines than the logical page can accommodate. This normal condition lets your program know when to execute its top-of-page routines. Top-of-page routines should contain `WRITE` statements with either the `AFTER ADVANCING PAGE` or `BEFORE ADVANCING PAGE` clause.

These statements determine when a report's logical page is full, and when the program prints the last line on a logical page (if you do not want to use all the lines on a page). Example 10–2 shows two methods that check for the page-overflow condition:

- Paragraph A100-FIRST-REPORT-ROUTINES checks for a full page after it writes a report line. If the page-overflow condition exists, A901-HEADER-ROUTINE executes.
- Paragraph A500-SECOND-REPORT-ROUTINES checks if more than 50 lines exist on the current logical page. If more than 50 lines exist, A902-HEADER-ROUTINE executes.

In either case, the `AFTER ADVANCING PAGE` clause in the A901-HEADER-ROUTINE and A902-HEADER-ROUTINE paragraphs generates the characters needed for the printer to position itself at the top of the next page heading area.

## Producing Printed Reports

### 10.5 Programming a Conventional File Report

#### Example 10–2 Checking for the Page-Overflow Condition

```
.
.
.
PROCEDURE DIVISION.
A000-BEGIN.
.
.
.
A100-FIRST-REPORT-ROUTINES.
*
* A901-HEADER-ROUTINE executes whenever the number of lines written exceeds
* the number of lines on the 66-line default logical page.
*
    WRITE A-LINE1 AFTER ADVANCING 2 LINES.
    ADD 2 TO REPORT1-LINE-COUNT.
    IF REPORT1-LINE-COUNT > 65 PERFORM A901-HEADER-ROUTINE.
.
.
.
A500-SECOND-REPORT-ROUTINES.
*
* This routine uses only the first 50 lines of the 66-line report.
*
    WRITE A-LINE2 AFTER ADVANCING 2 LINES.
    ADD 2 TO REPORT2-LINE-COUNT.
    IF REPORT2-LINE-COUNT IS GREATER THAN 50
        PERFORM A902-HEADER-ROUTINE.
.
.
.
A901-HEADER-ROUTINE.
    WRITE A-LINE1 FROM REPORT1-HEADER-LINE-1 AFTER ADVANCING PAGE.
    MOVE 0 TO REPORT1-LINE-COUNT.
    ADD 1 TO REPORT1-LINE-COUNT.
.
.
.
A902-HEADER-ROUTINE.
    WRITE A-LINE2 FROM REPORT2-HEADER-LINE-1 AFTER ADVANCING PAGE.
    MOVE 0 TO REPORT2-LINE-COUNT.
    ADD 1 TO REPORT2-LINE-COUNT.
.
.
.
```

Although the `WRITE` statement allows you to check for a page-overflow condition, you can also use a line counter that tracks the number of lines that appear on a page. Section 10.5.3.2 describes this in more detail.

#### 10.5.3.2 Using a Line Counter

A line counter is another method of tracking the number of lines that appear on a page. If you define a line counter in the Working-Storage Section of your program, each time a line is written or skipped the line counter value is incremented by one.

Your program should contain a routine that checks the line counter value before it writes or skips the next line. If the value is less than the limit you have set, it writes or skips. If the value equals or exceeds the limit you have set, the program executes header routines that allow it to advance to the next logical page.

## Producing Printed Reports 10.5 Programming a Conventional File Report

### 10.5.4 Printing the Conventional Report

When you are ready to print your report, you must ensure that your system's line printer can accommodate the page size or form of your report. If the printer uses a different page size or form, contact your system manager. The system manager can change the page or form size to accommodate your report.

Section 10.7 describes the different modes for printing a report.

### 10.5.5 A Conventional File Report Example

Example 10–3 shows an HP COBOL program that produces two reports from the same input file.

#### Example 10–3 Page Advancing and Line Skipping

```
IDENTIFICATION DIVISION.
PROGRAM-ID. REP01.
ENVIRONMENT DIVISION.
INPUT-OUTPUT SECTION.
FILE-CONTROL.
    SELECT INPUT-FILE    ASSIGN TO "REPIN.DAT".
    SELECT FORM1-REPORT ASSIGN TO "FORM1.DAT".
    SELECT FORM2-REPORT ASSIGN TO "FORM2.DAT".
DATA DIVISION.
FILE SECTION.
FD INPUT-FILE.
01 INPUT-RECORD.
    02 I-NAME.
        03 I-FIRST          PIC X(10).
        03 I-MID            PIC X.
        03 I-LAST          PIC X(15).
    02 I-ADDRESS.
        03 I-STREET        PIC X(20).
        03 I-CITY          PIC X(15).
        03 I-STATE         PIC XX.
        03 I-ZIP           PIC 99999.
FD FORM1-REPORT.
01 FORM1-PRINT-LINE          PIC X(80).
FD FORM2-REPORT.
01 FORM2-PRINT-LINE          PIC X(80).
WORKING-STORAGE SECTION.
01 END-OF-FILE                PIC X      VALUE SPACE.
01 MAX-LINES-ON-FORM2         PIC 99     VALUE 55.
01 FORM2-LINE-COUNTER         PIC 99     VALUE 00.
01 PAGE-NO                    PIC 99999  VALUE 0.
01 FORM1-LINE-3.
    02                          PIC X(9)   VALUE SPACES.
    02 FORM1-LAST             PIC X(15).
01 FORM1-LINE-13.
    02                          PIC X(4)   VALUE SPACES.
    02 FORM1-NAME             PIC X(26).
```

(continued on next page)

## Producing Printed Reports

### 10.5 Programming a Conventional File Report

#### Example 10-3 (Cont.) Page Advancing and Line Skipping

```
01 FORM1-LINE-14.
   02                                     PIC X(4)  VALUE SPACES.
   02 FORM1-STREET                       PIC X(20).
01 FORM1-LINE-15.
   02                                     PIC X(4)  VALUE SPACES.
   02 FORM1-CITY                         PIC X(15).
   02                                     PIC X      VALUE SPACE.
   02 FORM1-STATE                       PIC XX.
   02                                     PIC X      VALUE SPACE.
   02 FORM1-ZIP                          PIC 99999.
01 FORM2-HEADER-1.
   02          PIC X(15) VALUE SPACES.
   02          PIC X(30) VALUE "  PERSONNEL MASTER LISTING  ".
   02          PIC X(10) VALUE SPACES.
   02          PIC XXXXX VALUE "Page ".
   02 F2H-PAGE PIC ZZZZZ.
01 FORM2-HEADER-2.
   02          PIC X(15) VALUE SPACES.
   02          PIC X(30) VALUE "**** COMPANY CONFIDENTIAL ****".

PROCEDURE DIVISION.
A000-BEGIN.
  OPEN INPUT  INPUT-FILE
        OUTPUT FORM1-REPORT
        FORM2-REPORT.
  PERFORM A900-PRINT-HEADERS-ROUTINE.
  PERFORM A100-PRINT-REPORTS UNTIL END-OF-FILE = "Y".
  CLOSE INPUT-FILE
        FORM1-REPORT
        FORM2-REPORT.
  DISPLAY "END OF JOB".
  STOP RUN.

A100-PRINT-REPORTS.
  READ INPUT-FILE AT END MOVE "Y" TO END-OF-FILE.
  IF END-OF-FILE NOT = "Y"
    PERFORM A200-PRINT-REPORTS.
A200-PRINT-REPORTS.
  IF FORM2-LINE-COUNTER IS GREATER THAN MAX-LINES-ON-FORM2
    PERFORM A900-PRINT-HEADERS-ROUTINE.
  WRITE FORM2-PRINT-LINE FROM INPUT-RECORD
        AFTER ADVANCING 2 LINES.
  ADD 2 TO FORM2-LINE-COUNTER.
  MOVE I-LAST      TO FORM1-LAST.
  WRITE FORM1-PRINT-LINE FROM FORM1-LINE-3
        AFTER ADVANCING 3 LINES.
  MOVE I-NAME      TO FORM1-NAME.
  WRITE FORM1-PRINT-LINE FROM FORM1-LINE-13
        AFTER ADVANCING 10 LINES.
  MOVE I-STREET    TO FORM1-STREET.
  WRITE FORM1-PRINT-LINE FROM FORM1-LINE-14.
  MOVE I-CITY      TO FORM1-CITY.
  MOVE I-STATE     TO FORM1-STATE.
  MOVE I-ZIP       TO FORM1-ZIP.
  WRITE FORM1-PRINT-LINE FROM FORM1-LINE-15.
```

(continued on next page)



## Producing Printed Reports 10.5 Programming a Conventional File Report

### Example 10–3 (Cont.) Page Advancing and Line Skipping

```
A900-PRINT-HEADERS-ROUTINE.
*
* This routine generates a form feed, writes two lines,
* skips two lines, then resets the line counter to 4 to
* indicate used lines on the current logical page.
* Line 5 on this page is the next print line.
*
  ADD 1 TO PAGE-NO.
  MOVE PAGE-NO TO F2H-PAGE.
  WRITE FORM2-PRINT-LINE FROM FORM2-HEADER-1
                                AFTER ADVANCING PAGE.
  WRITE FORM2-PRINT-LINE FROM FORM2-HEADER-2
                                BEFORE ADVANCING 2.
  MOVE 4 TO FORM2-LINE-COUNTER.
```

The first report, Figure 10–4, is a preprinted form letter that can be inserted into a business envelope. This report has a logical page length of 20 lines and a width of 80 characters. Note that this report uses only the first 15 lines on the page. Because this is a preprinted form, the program supplies only the following information:

- The date for line 3
- The customer’s name for lines 3 and 13
- The customer’s address for lines 14 and 15

**Figure 10–4 A 20-Line Logical Page**

	1	2	3	4	5	6
Column	12345678901234567890123456789012345678901234567890123456789012					
Line						
1						
2						
3	Dear Mr. XXXXXXXXXXXXXXXX			Date: 99-XXX-99		
4						
5	XX					
6	X					X
7	X					X
8	X	← Preprint message is here →				X
9	X					X
10	X					X
11	XX					
12						
13	TO: XXXXXXXXXXXX X XXXXXXXXXXXXXXXX					
14	XXXXXXXXXXXXX X XXXXXXXX					
15	XXXXXXXXXXXXXXXXXX XX 99999					
16						
17						
18						
19						
20						

ZK-6082-GE

## Producing Printed Reports

### 10.5 Programming a Conventional File Report

The second report, Figure 10–5, is a double-spaced master listing of all input records. While this report's logical page is identical to the default logical page for the system (in this case, 66 vertical lines and 132 horizontal characters), this report uses only the first 55 lines on the page. Both reports are output to a disk for later printing.

Figure 10–5 A Double-Spaced Master Listing

PERSONNEL MASTER LISTING					Page 1
**** COMPANY CONFIDENTIAL ****					
Harold	AHuit	1234 Main Street	Southbend	VT12345	
Mary	QJewitt	18673 S. 126 Avenue	Kreosote	NB87655	
George	DCarport	990 North St., Apt 3	Waymouth	AL00001	
Catherine	FBallet	2244 Maple St	Laconia	NH03456	
Amanda	DModel	Pease AFB	Portsmouth	VT24567	
Robert	RLumber	2 Wayne St.	Ackensack	NJ56243	

ZK-6083-GE

### 10.6 Programming a Linage-File HP COBOL Report

A lineage-file report has sequential organization and access mode, and consists of one or more logical pages. An HP COBOL program that produces a lineage-file report uses the LINAGE and LINAGE-COUNTER capabilities in addition to the facilities used for conventional reports.

In contrast to the conventional COBOL report, you can use the LINAGE clause to do the following:

- Define the number of lines on the logical page.
- Divide the logical page into sections.

Additionally, a lineage-file report has a LINAGE-COUNTER special register assigned to it that monitors the number of lines written to the current logical page.

To program a lineage report, you should understand how to do the following:

- Define the logical page with the LINAGE clause.
- Use the LINAGE-COUNTER special register.
- Advance to the next logical page.
- Program for the page-overflow condition.

On OpenVMS, the lineage file contains variable length with fixed control records. All advancing information is encoded in the fixed control portion of the record. ♦

## Producing Printed Reports 10.6 Programming a Linage-File HP COBOL Report

On Tru64 UNIX, the lineage file contains variable length records. All advancing information is written to the file as blank lines. ♦

The following sections discuss these topics in detail. Example 10–5 shows an example of a lineage-file program.

### 10.6.1 Defining the Logical Page in a Linage-File Report

Your program specifies the format of your report. Using the report layout worksheet you created, you can write an HP COBOL program that defines the logical page area and divides the page into logical page sections for a lineage-file report. Figure 10–6 shows the logical page area and the four divisions of a lineage-file report.

**Figure 10–6 Logical Page Areas for a Linage-File Report**

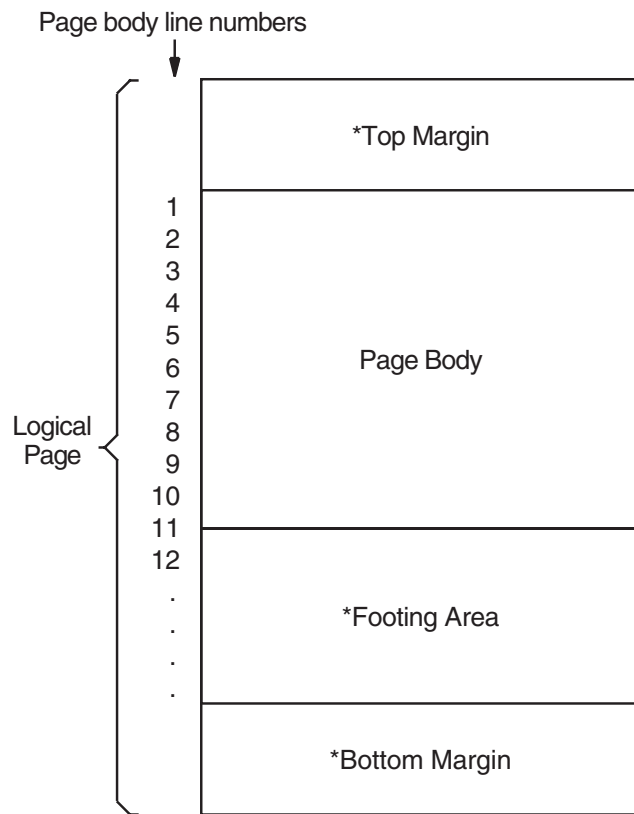

\*Optional areas

ZK-6084-GE

To define the number of lines on a logical page and to divide it into logical page sections, you must include the `LINAGE` clause as a File Description entry in your program. The `LINAGE` clause lets you specify the size of the logical page's top and bottom margins and the line where the footing area begins in the page body.

## Producing Printed Reports

### 10.6 Programming a Linage-File HP COBOL Report

For example, to define how many lines you want your program to skip at the top or bottom of the logical page, use the `LINAGE` clause with either the `LINES AT TOP` or the `LINES AT BOTTOM` phrase. To define a footing area within the logical page, use the `LINAGE` clause with the `WITH FOOTING` phrase.

The `LINES AT TOP` phrase positions the printer on the first print line in the page body. The `LINES AT BOTTOM` phrase positions the printer at the top of the next logical page once the current page body is complete. The `WITH FOOTING` phrase defines a footing area in the logical page that controls page-overflow conditions. Additionally, you can insert specific text, such as footnotes or page numbers, on the bottom lines of your logical page.

In addition to defining the logical page area and the number of lines that appear on a page, you must be prepared to handle vertical spacing, horizontal spacing, logical page advancement, and page-overflow. The following sections discuss these topics in detail.

#### 10.6.2 Controlling the Spacing in a Linage-File Report

To control the horizontal spacing on a logical page, define every report item from your report layout worksheet in the Working-Storage Section of your HP COBOL program.

To control the vertical spacing on a logical page, use the `WRITE` statement. The `WRITE` statement controls whether one or more lines is skipped before or after your program writes a line of the report. For example, to print a line before advancing five lines, use the following:

```
WRITE... BEFORE ADVANCING 5 LINES.
```

To print a line after advancing two lines, use the following:

```
WRITE... AFTER ADVANCING 2 LINES.
```

#### 10.6.3 Using the `LINAGE-COUNTER`

The `LINAGE-COUNTER` special register is one method of tracking the number of lines that your program writes on a logical page. When you use the `LINAGE-COUNTER` special register, each time a line is written or skipped, the register is incremented by 1.

Before the program writes a new line, it checks the `LINAGE-COUNTER` value to see if the current logical page can accept the new line. If the value equals the maximum number of lines for the page body, the compiler positions the pointer on the first print line of the next page body. The compiler automatically resets this register to 1 each time your program begins a new logical page.

If you choose not to use the `LINAGE-COUNTER` register, you can advance to the next logical page using the `WRITE` statement, as explained in Section 10.6.4.

#### 10.6.4 Advancing to the Next Logical Page in a Linage-File Report

Linage-files automatically advance to the next logical page when the `LINAGE-COUNTER` value equals the number of lines on the logical page. However, HP COBOL also lets your program control logical page advancement with the `WRITE` statement.

To manually advance to the next logical page from any line in the current page body and position the printer on the first print line of the next page body, your program must include the `WRITE` statement with either the `BEFORE`

## Producing Printed Reports

### 10.6 Programming a Linage-File HP COBOL Report

ADVANCING PAGE clause or the AFTER ADVANCING PAGE clause. For an example of the WRITE statement, see Section 10.6.7.

Section 10.6.5 describes how to handle a page-overflow condition.

#### 10.6.5 Programming for the End-of-Page and Page-Overflow Condition

A page-overflow condition occurs when your program writes more lines than the logical page can accommodate. Although the compiler automatically advances to the next logical page when you use the LINAGE-COUNTER register, header information is not printed, and the next line begins on the next logical page.

If you want your program to advance to the next page and print page headers on the new page when the page is full, you should include routines in your program that limit the number of lines on each logical page.

Example 10–4 demonstrates how to include these routines in your program using the logical page shown in Figure 10–7.

In Figure 10–7, each detail line of the report represents a separate purchase at the XYZ Clothing Store. Each page can contain from 1 to 18 purchase lines. Each customer can have an unlimited number of purchases. A total of purchases for each customer is to appear on line 25 of that customer’s last statement page. Headers appear on the top of each page.

The input file, INPUT.DAT, consists of individual purchase records sorted in ascending order by customer account number and purchase date. In Example 10–4, the LINAGE clause defines a footing area so the program can check for an end-of-page condition. When the condition is detected, the program executes its header routine to print lines 1 to 7.

# Producing Printed Reports

## 10.6 Programming a Linage-File HP COBOL Report

Figure 10-7 A 28-Line Logical Page

Column Line		1	2	3	4	5	6	
		12345678901234567890123456789012345678901234567890123456789012						
1	P	XYZ Clothing Store					Page: 99999999	
2	P	STATEMENT OF ACCOUNT					Date: 99-XXX-99	
3	P							
4	P	Name: XXXXXXXXXXXX X XXXXXXXXXXXXXXXX		Account Number: 99999999				
5	P	Address: XX						
6	P	Date:	Amount	Description				
7	P	-----						
8	P	XX						
9	P	X					X	
10	P	X					X	
11	P	X					X	
12	P	X					X	
13	P	X					X	
14	P	X					X	
15	P	X					X	
16	P	X					X	
17	P	X					X	
18	P	X					X	
19	P	X					X	
20	P	X					X	
21	P	X					X	
22	P	X					X	
23	P	X					X	
24	P	X					X	
25	FP	XX						
26	FP							
27	B							
28	B							

Legend: T = Top margin = none  
 P = Page body = lines 01-26  
 F = Footing area = lines 25-26  
 B = Bottom margin = lines 27-28

VM-0324A-AI

### Example 10-4 Checking for End-of-Page on a 28-Line Logical Page

```
IDENTIFICATION DIVISION.
PROGRAM-ID. REPOVF.
ENVIRONMENT DIVISION.
INPUT-OUTPUT SECTION.
FILE-CONTROL.
    SELECT INPUT-FILE ASSIGN TO "INPUT.DAT".
    SELECT REPORT-FILE ASSIGN TO "REPORT.DAT".
```

(continued on next page)

## Producing Printed Reports 10.6 Programming a Linage-File HP COBOL Report

### Example 10-4 (Cont.) Checking for End-of-Page on a 28-Line Logical Page

```
DATA DIVISION.
FILE SECTION.
FD INPUT-FILE.
01 INPUT-RECORD.
   02 I-NAME.
       03 I-FIRST          PIC X(10).
       03 I-MID           PIC X.
       03 I-LAST          PIC X(15).
   02 I-ADDRESS.
       03 I-STREET        PIC X(20).
       03 I-CITY          PIC X(15).
       03 I-STATE         PIC XX.
       03 I-ZIP           PIC 99999.
   02 I-ACCOUNT-NUMBER    PIC X(9).
   02 I-PURCHASE-DATE     PIC XXXXXX.
   02 I-PURCHASE-AMOUNT   PIC S9(6)V99.
   02 I-PURCHASE-DESCRIP  PIC X(20).
FD REPORT-FILE
   LINAGE IS 26 LINES
       WITH FOOTING AT 25
       LINES AT BOTTOM 2.
01 PRINT-LINE             PIC X(80).
WORKING-STORAGE SECTION.
01 HEAD-1.
   02 H1-LC      PIC 99.
   02 FILLER    PIC X(20) VALUE "XYZ Clothing Store ".
   02 FILLER    PIC X(25) VALUE SPACES.
   02 FILLER    PIC X(6)  VALUE "Page: ".
   02 H1-PAGE   PIC Z(9).
01 HEAD-2.
   02 H2-LC      PIC 99.
   02 FILLER    PIC X(20) VALUE "STATEMENT OF ACCOUNT".
   02 FILLER    PIC X(25) VALUE SPACES.
   02 FILLER    PIC X(6)  VALUE "Date: ".
   02 H2-DATE   PIC X(9).
01 HEAD-3.
   02 H3-LC      PIC 99.
   02 FILLER    PIC X(6)  VALUE "Name: ".
   02 H3-FNAME  PIC X(10).
   02 FILLER    PIC X      VALUE SPACE.
   02 H3-MNAME  PIC X.
   02 FILLER    PIC X      VALUE SPACE.
   02 H3-LNAME  PIC X(15).
   02 FILLER    PIC X(17) VALUE " Account Number: ".
   02 H3-NUM    PIC Z(9).
01 HEAD-4.
   02 H4-LC      PIC 99.
   02 FILLER    PIC X(9)  VALUE "Address: ".
   02 H4-STRT   PIC X(20).
   02 FILLER    PIC X      VALUE SPACE.
   02 H4-CITY   PIC X(15).
   02 FILLER    PIC X      VALUE SPACE.
   02 H4-STATE  PIC XX.
   02 FILLER    PIC X      VALUE SPACE.
   02 H4-ZIP    PIC 99999.
```

(continued on next page)

## Producing Printed Reports

### 10.6 Programming a Linage-File HP COBOL Report

#### Example 10-4 (Cont.) Checking for End-of-Page on a 28-Line Logical Page

```
01 HEAD-5.
   02 H5-LC      PIC 99.
   02 FILLER    PIC X(4) VALUE "Date".
   02 FILLER    PIC X(7) VALUE SPACES.
   02 FILLER    PIC X(6) VALUE "Amount".
   02 FILLER    PIC X(10) VALUE SPACES.
   02 FILLER    PIC X(11) VALUE "Description".
01 HEAD-6      PIC X(61) VALUE ALL "-".
01 DETAIL-LINE.
   02 DET-LC    PIC 99.
   02 DL-DATE   PIC X(9).
   02 FILLER    PIC X      VALUE SPACE.
   02 DL-AMT    PIC $$$,ZZZ.99-.
   02 FILLER    PIC X      VALUE SPACE.
   02 DL-DESC   PIC X(20).
01 TOTAL-LINE.
   02 TOT-LC    PIC 99.
   02 FILLER    PIC X(25) VALUE "Total purchases to date: ".
   02 TL        PIC $$$,ZZZ,ZZZ.99-.
01 TOTAL-PURCHASES PIC S9(9)V99.
01 PAGE-NUMBER     PIC S9(9).
01 HOLD-I-ACCOUNT-NUMBER PIC X(9) VALUE IS LOW-VALUES.
01 END-OF-FILE     PIC X      VALUE IS "N".
01 THESE-MANY     PIC 99      VALUE IS 1.

PROCEDURE DIVISION.
A000-BEGIN.
   OPEN INPUT INPUT-FILE
        OUTPUT REPORT-FILE.
   DISPLAY " Enter date--DD-MMM-YY:".
   ACCEPT H2-DATE.
   PERFORM A100-READ-INPUT UNTIL END-OF-FILE = "Y".
A050-WRAP-UP.
   CLOSE INPUT-FILE
        REPORT-FILE.
   DISPLAY "END-OF-JOB".
   STOP RUN.
A100-READ-INPUT.
   READ INPUT-FILE AT END MOVE "Y" TO END-OF-FILE
        PERFORM A400-PRINT-TOTALS
        MOVE HIGH-VALUES TO I-ACCOUNT-NUMBER.
   DISPLAY INPUT-RECORD.
   IF END-OF-FILE NOT = "Y"
       AND I-ACCOUNT-NUMBER NOT = HOLD-I-ACCOUNT-NUMBER
       PERFORM A200-NEW-CUSTOMER.
   IF END-OF-FILE NOT = "Y"
       AND I-ACCOUNT-NUMBER = HOLD-I-ACCOUNT-NUMBER
       PERFORM A300-PRINT-DETAIL-LINE.
   MOVE I-ACCOUNT-NUMBER TO HOLD-I-ACCOUNT-NUMBER.
A200-NEW-CUSTOMER.
   IF HOLD-I-ACCOUNT-NUMBER = LOW-VALUES
       PERFORM A600-SET-UP-HEADERS
       PERFORM A500-PRINT-HEADERS
       PERFORM A300-PRINT-DETAIL-LINE
   ELSE
       PERFORM A400-PRINT-TOTALS
       PERFORM A600-SET-UP-HEADERS
       PERFORM A500-PRINT-HEADERS
       PERFORM A300-PRINT-DETAIL-LINE.
```

(continued on next page)



## Producing Printed Reports 10.6 Programming a Linage-File HP COBOL Report

### Example 10–4 (Cont.) Checking for End-of-Page on a 28-Line Logical Page

```
A300-PRINT-DETAIL-LINE.  
    MOVE I-PURCHASE-DATE    TO DL-DATE.  
    MOVE I-PURCHASE-AMOUNT  TO DL-AMT.  
    MOVE I-PURCHASE-DESCRIP TO DL-DESC.  
* At EOP this last detail line goes in footing area of current page  
  WRITE PRINT-LINE FROM DETAIL-LINE  
    AT END-OF-PAGE PERFORM A500-PRINT-HEADERS.  
  ADD I-PURCHASE-AMOUNT TO TOTAL-PURCHASES.  
A400-PRINT-TOTALS.  
  MOVE TOTAL-PURCHASES TO TL.  
* Skip to footing area  
  COMPUTE THESE-MANY = 25 - LINAGE-COUNTER.  
  WRITE PRINT-LINE FROM TOTAL-LINE AFTER ADVANCING THESE-MANY LINES.  
  MOVE 0 TO TOTAL-PURCHASES.  
A500-PRINT-HEADERS.  
  ADD 1 TO PAGE-NUMBER.  
  MOVE PAGE-NUMBER TO H1-PAGE.  
  WRITE PRINT-LINE FROM HEAD-1 AFTER ADVANCING PAGE.  
  WRITE PRINT-LINE FROM HEAD-2.  
  MOVE SPACES TO PRINT-LINE.  
  WRITE PRINT-LINE.  
  WRITE PRINT-LINE FROM HEAD-3.  
  WRITE PRINT-LINE FROM HEAD-4.  
  WRITE PRINT-LINE FROM HEAD-5.  
  WRITE PRINT-LINE FROM HEAD-6.  
A600-SET-UP-HEADERS.  
  MOVE I-FIRST      TO H3-FNAME.  
  MOVE I-MID        TO H3-MNAME.  
  MOVE I-LAST       TO H3-LNAME.  
  MOVE I-ACCOUNT-NUMBER TO H3-NUM.  
  MOVE I-STREET     TO H4-STRT.  
  MOVE I-CITY       TO H4-CITY.  
  MOVE I-STATE      TO H4-STATE.  
  MOVE I-ZIP        TO H4-ZIP.
```

### 10.6.6 Printing a Linage-File Report

The default PRINT command inserts a page ejection when a form nears the end of a page. Therefore, when the default PRINT command refers to a lineage-file report, it can change the report's page spacing.

On Tru64 UNIX systems, to print a lineage-file report, use this command:

```
% lpr report-file-specification ◆
```

On OpenVMS systems, to print a lineage-file report, use the /NOFEED qualifier with the DCL PRINT command as follows:

```
$ PRINT report-file-specification/NOFEED
```

On OpenVMS systems, the LINAGE clause causes an HP COBOL report file to be in print-file format. (See Chapter 6 for more information.) ◆

When a WRITE statement positions the file to the top of the next logical page, the device is positioned by line spacing rather than by page ejection or form feed.

For more information on printing your report, see Section 10.7.

# Producing Printed Reports

## 10.6 Programming a Linage-File HP COBOL Report

### 10.6.7 A Linage-File Report Example

Example 10–5 shows an HP COBOL program that produces a lineage-file report.

The LINAGE clause in the following File Description entry defines the logical page areas shown in Figure 10–8:

```
FD MINIF1-REPORT
   LINAGE IS 13 LINES
                               LINES AT TOP      2
                               LINES AT BOTTOM    5.
```

Figure 10–8 shows a 20-line logical page that includes a top margin (T), a page body (P), and a bottom margin (B).

**Figure 10–8 A 20-Line Logical Page**

Column Line		1	2	3	4	5	6
		12345678901234567890123456789012345678901234567890123456789012					
1	T						
2	T						
3	P	Dear Mr. XXXXXXXXXXXXXXXX			Date: 99-XXX-99		
4	P						
5	P	XX					
6	P	X					X
7	P	X					X
8	P	X	← Preprint message is here →				X
9	P	X					X
10	P	X					X
11	P	XX					
12	P						
13	P	TO: XXXXXXXXXXXX X XXXXXXXXXXXXXXXX					
14	P	XXXXXXXXXXXXX X XXXXXXXX					
15	P	XXXXXXXXXXXXXXXXXXXX XX 99999					
16	B						
17	B						
18	B						
19	B						
20	B						

Legend: T = Top margin = lines 1 and 2  
 P = Page body = lines 3 through 15  
 F = Footing area = none  
 B = Bottom margin = lines 16 through 20

VM-0325A-AI

The first line to which the logical page can be positioned is the third line on the page; this is the first print line. The page-overflow condition occurs when a WRITE statement causes the LINAGE-COUNTER value to equal 15. Line 15 is the last line on the page on which text can be written. The page advances to the next logical page when a WRITE statement causes the LINAGE-COUNTER value to exceed 15. The pointer is then positioned on the first print line of the next logical page.

## Producing Printed Reports

### 10.6 Programming a Linage-File HP COBOL Report

LINAGE is the sum of N (where N represents the number of lines of text) plus X (where X represents the number of lines at the top) plus Y (where Y represents the number of lines at the bottom). The sum total should not exceed the length of the physical page, which is usually 66 lines.

## Producing Printed Reports

### 10.6 Programming a Linage-File HP COBOL Report

#### Example 10-5 Programming a 20-Line Logical Page Defined by the LINAGE Clause with Automatic Page Overflow

```
IDENTIFICATION DIVISION.
PROGRAM-ID. REPLINAG.
ENVIRONMENT DIVISION.
INPUT-OUTPUT SECTION.
FILE-CONTROL.
    SELECT INPUT-FILE    ASSIGN TO "REPIN.DAT".
    SELECT MINIF1-REPORT ASSIGN TO "MINIF1.DAT".
DATA DIVISION.
FILE SECTION.
FD INPUT-FILE.
01 INPUT-RECORD.
    02 I-NAME.
        03 I-FIRST          PIC X(10).
        03 I-MID            PIC X.
        03 I-LAST          PIC X(15).
    02 I-ADDRESS.
        03 I-STREET        PIC X(20).
        03 I-CITY          PIC X(15).
        03 I-STATE         PIC XX.
        03 I-ZIP           PIC 99999.
FD MINIF1-REPORT
    LINAGE IS 13 LINES
        LINES AT TOP      2
        LINES AT BOTTOM  5.
01 MINIF1-PRINT-LINE          PIC X(80).
WORKING-STORAGE SECTION.
01 END-OF-FILE                PIC X    VALUE SPACE.
01 LINE-UP-OK                 PIC X    VALUE SPACE.
01 MINIF1-LINE-3.
    02 FILLER                  PIC X(9)  VALUE SPACES.
    02 MINIF1-LAST             PIC X(15).
    02 FILLER                  PIC X(23) VALUE SPACES.
    02 FILLER                  PIC X(6)  VALUE "Date: ".
    02 MINIF1-DATE             PIC 99/99/99.
01 MINIF1-LINE-13.
    02 FILLER                  PIC X(4)  VALUE SPACES.
    02 MINIF1-NAME             PIC X(26).
01 MINIF1-LINE-14.
    02 FILLER                  PIC X(4)  VALUE SPACES.
    02 MINIF1-STREET          PIC X(20).
01 MINIF1-LINE-15.
    02 FILLER                  PIC X(4)  VALUE SPACES.
    02 MINIF1-CITY            PIC X(15).
    02 FILLER                  PIC X    VALUE SPACE.
    02 MINIF1-STATE           PIC XX.
    02 FILLER                  PIC X    VALUE SPACE.
    02 MINIF1-ZIP             PIC 99999.
PROCEDURE DIVISION.
A000-BEGIN.
    OPEN OUTPUT MINIF1-REPORT.
    ACCEPT MINIF1-DATE FROM DATE.
    PERFORM A300-FORM-LINE-UP UNTIL LINE-UP-OK = "Y".
    OPEN INPUT INPUT-FILE.
    PERFORM A100-READ-INPUT UNTIL END-OF-FILE = "Y".
A010-WRAP-UP.
    CLOSE INPUT-FILE
        MINIF1-REPORT.
    DISPLAY "END OF JOB".
    STOP RUN.
```

(continued on next page)

## Producing Printed Reports

### 10.6 Programming a Linage-File HP COBOL Report

#### Example 10–5 (Cont.) Programming a 20-Line Logical Page Defined by the LINAGE Clause with Automatic Page Overflow

```
A100-READ-INPUT.
  READ INPUT-FILE AT END MOVE "Y" TO END-OF-FILE.
  IF END-OF-FILE NOT = "Y"
    PERFORM A200-PRINT-REPORT.
A200-PRINT-REPORT.
  MOVE I-LAST          TO MINIF1-LAST.
  WRITE MINIF1-PRINT-LINE FROM MINIF1-LINE-3 BEFORE ADVANCING 1 LINE.
  MOVE SPACES TO MINIF1-PRINT-LINE.
  WRITE MINIF1-PRINT-LINE AFTER ADVANCING 9 LINES.
  MOVE I-NAME          TO MINIF1-NAME.
  WRITE MINIF1-PRINT-LINE FROM MINIF1-LINE-13 BEFORE ADVANCING 1 LINE.
  MOVE I-STREET        TO MINIF1-STREET.
  WRITE MINIF1-PRINT-LINE FROM MINIF1-LINE-14 BEFORE ADVANCING 1 LINE.
  MOVE I-CITY          TO MINIF1-CITY.
  MOVE I-STATE         TO MINIF1-STATE.
  MOVE I-ZIP           TO MINIF1-ZIP.
  WRITE MINIF1-PRINT-LINE FROM MINIF1-LINE-15 BEFORE ADVANCING 1 LINE.
A300-FORM-LINE-UP.
  MOVE ALL "X" TO INPUT-RECORD.
  PERFORM A200-PRINT-REPORT 3 TIMES.
  DISPLAY "Is Alignment OK? (Y/N): " WITH NO ADVANCING.
  ACCEPT LINE-UP-OK.
```

## 10.7 Modes for Printing Reports

Your HP COBOL program can spool the report to a mass storage device for printing later. Section 10.7.1 describes this mode of printing.

### 10.7.1 Spooling to a Mass Storage Device

To spool your report to a mass storage device (such as a disk or magnetic tape) for later printing, your HP COBOL program must include a file specification. For example, to spool JAN28P.DAT you would include the following code in your program:

```
SELECT REPORT-FILE ASSIGN TO "USER1$:JAN28P".    (OpenVMS)
SELECT REPORT-FILE ASSIGN TO "/usr1$/JAN28P".    (Tru64 UNIX)
```

Spooling to a mass storage device has the following advantages:

- You can run your job at any time regardless of other printer activity and printer status.
- Your application program does not make immediate resource demands on the printer.
- You can schedule the printing based on production and shop requirements, and print the file according to your priority needs.
- You optimize use of the printer. Spooling results in printing the maximum number of lines per minute.
- You have a backup of the file.

Spooling to a mass storage device has the following disadvantages:

- You do not see immediate results.

## Producing Printed Reports

### 10.7 Modes for Printing Reports

- It is difficult and expensive to input preprinted form numbers (for example, check numbers) from your forms into your report file.

### 10.8 Programming a Report Writer Report

Report Writer allows you to describe the appearance of a report's format. To do this, you specify the Report Writer statements that describe the report's contents and control in the Report Section of the Data Division. These statements replace many complex, detailed procedures that you would otherwise have to include in a conventional or lineage-file report.

The following sections explain how to produce a report with the Report Writer. These sections describe how to do the following:

- Use the REPORT clause in the FD statement of the FILE section.
- Define the Report Section and the report description.
- Define the Report Writer logical page.
- Specify multiple reports.
- Define and increment totals.
- Process a Report Writer report.
- Select a Report Writer type.

Detailed examples using Report Writer are documented in Section 10.9.

#### 10.8.1 Using the REPORT Clause in the File Section

To create a report with Report Writer, you must write a report to a specific file. That file is described by a File Description (FD) entry; however, unlike a conventional or lineage-file report, your FD entry for a Report Writer file must contain the REPORT clause, and you must assign a name for each report in the REPORT clause.

For instance, in the following example, the File Description on the left does not specify Report Writer; however, the example on the right correctly shows a Report Writer File Section entry:

FD SALES-REPORT		FD SALES-REPORT
.		.
.		.
.		.
01 SALES-AREA PIC X(133).		
01 PRINT-AREA PIC X(133).		REPORT IS MASTER-LIST.

To completely describe the report that you specify in the REPORT clause, you must define a Report Section in the Data Division. Section 10.8.2 describes the Report Section.

#### 10.8.2 Defining the Report Section and the Report File

The Report Section in the Data Division provides specific information about the reports that are specified with the REPORT clause. Each report named in the Data Division File Section also must be defined in the Report Section.

To define a report, use a Report Description (RD) entry followed by one or more Report Group Description entries (01-level) in the Report Section. For example:

## Producing Printed Reports 10.8 Programming a Report Writer Report

```
FILE SECTION.  
FD SALES-REPORT  
  REPORT IS MASTER-LIST.  
  .  
  .  
REPORT SECTION.  
RD MASTER-LIST  
  PAGE LIMIT IS 66  
  HEADING      1  
  FIRST DETAIL 13  
  LAST DETAIL  30  
  FOOTING      50.
```

The RD supplies information about the format of the printed page and the organization of the subdivisions (see Section 10.8.4).

### 10.8.3 Defining a Report Writer Logical Page with the PAGE Clause

To define the logical page for a Report Writer report, you use the PAGE clause. This clause enables you to specify the number of lines on a page and the format of that page. For example, the PAGE clause allows you to specify where the heading, detail, and footing appear on the printed page. If you want to use vertical formatting, you must use the PAGE clause.

The RD entry example in Section 10.8.2 contains the following PAGE clause information:

RD Entry Line		Meaning
PAGE LIMIT IS	66	Maximum number of lines per page is 66
HEADING	1	Line number on which the first report heading (RH) or page heading (PH) should print on each page
FIRST DETAIL	13	First line number on which a control heading (CH), detail (DE), or control footing (CF) should print on a page
LAST DETAIL	30	Last line number on which a CH or DE can print on a page
FOOTING	50	Last line number on which a control footing (CF) can print on a page (if specified, page footing (PF) and report footing (RF) report groups follow the line number shown in FOOTING)

The PAGE LIMIT clause line numbers are in ascending order and must not exceed the number specified in the PAGE LIMIT clause (in this example, 66 lines).

Section 10.8.4 describes report group entries in more detail.

### 10.8.4 Describing Report Group Description Entries

In a Report Writer program, report groups are the basic elements that make up the logical page. There are seven types of report groups, which consist of one or more report lines printed as a complete unit (for example, a page heading). Each report line can be subdivided into data items or fields.

Table 10–1 lists the seven types of report groups:

## Producing Printed Reports

### 10.8 Programming a Report Writer Report

**Table 10–1 Report Writer Report Group Types**

Report Group Type	Description
REPORT HEADING	Prints a title or any other information that pertains to the entire report
PAGE HEADING	Prints a page heading and column headings
CONTROL HEADING	Prints a heading when a control break occurs
DETAIL	Prints the primary data of the report
CONTROL FOOTING	Prints totals when a control break occurs
PAGE FOOTING	Prints totals or comments at the bottom of each page
REPORT FOOTING	Prints trailer information for the report

A Report Writer program can include both printable report groups and null report groups. Null report groups are groups that do not print but are used for control breaks.

Figure 10–9 shows the report group presentation order found on a logical page. You must code at least one **DETAIL** report group (printable or null) in your program to produce a report. All other report groups are optional. Note that you can code a report group by using the abbreviations shown in Figure 10–9.

**Figure 10–9 Presentation Order for a Logical Page**

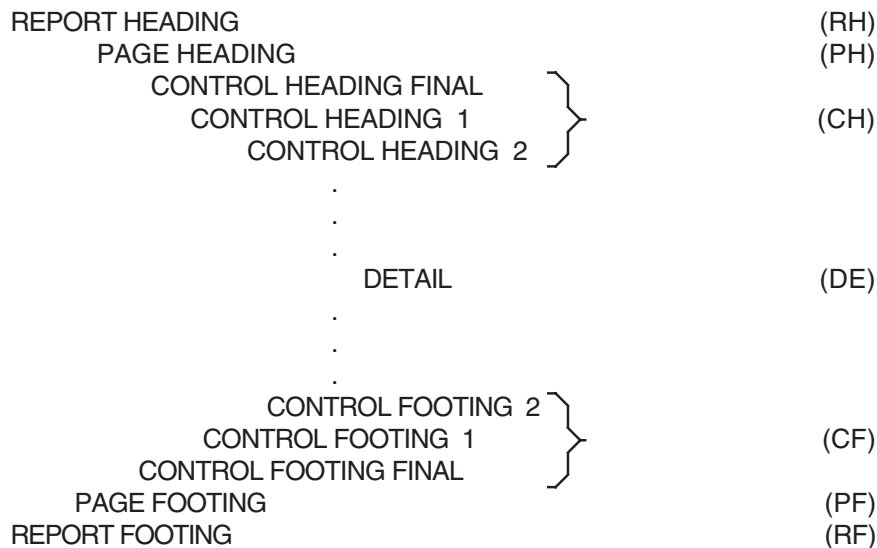

ZK-6087-GE

Figure 10–10 shows a report that uses all seven of the report groups listed in the preceding table.



## Producing Printed Reports 10.8 Programming a Report Writer Report

Figure 10–10 Sample Report Using All Seven Report Groups

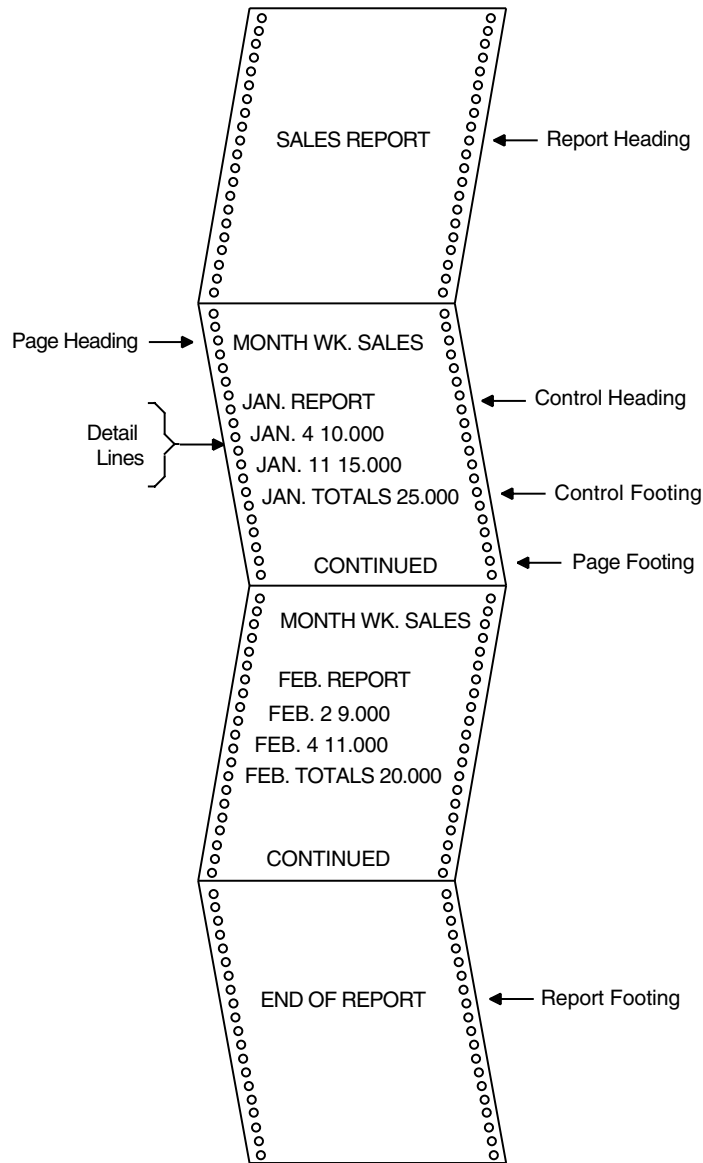

ZK-1551-GE

To code report groups, you use an 01-level entry to describe the physical and logical characteristics of the report group and the Report Writer TYPE clause to indicate the type of the report group. The TYPE clause can be preceded by a user-defined report group name. The CONTROL HEADING and FOOTING report groups use data names that are also specified as CONTROL clause names in the Report Description entry (see Section 10.8.10 for CONTROL clause information).

## Producing Printed Reports

### 10.8 Programming a Report Writer Report

The following example shows how to use the TYPE and CONTROL clauses:

```
DATA DIVISION.  
REPORT SECTION.  
01 REPORT-HEADER TYPE IS REPORT HEADING.  
01 PAGE-HEADER TYPE IS PAGE HEADING.  
01 CONTROL-HEADER TYPE IS CONTROL HEADING CONTROL-NAME-1.  
01 DETAIL-LINE TYPE IS DETAIL.  
01 CONTROL-FOOTER TYPE IS CONTROL FOOTING CONTROL-NAME-2.  
01 PAGE-FOOTER TYPE IS PAGE FOOTING.  
01 REPORT-FOOTER TYPE IS REPORT FOOTING.
```

#### 10.8.5 Vertical Spacing for the Logical Page

You use the LINE clause for positioning vertical lines within a report group or for indicating vertical line space between two report groups. The LINE clause indicates the start of an absolute print line (a specific line on a page) or where a relative print line (an increment to the last line printed) is to print on the page. You can use this clause with all report groups.

In the following example, the LINE clause indicates that this report group begins on absolute line number 5 on a page. LINE IS 7 indicates that this report group has a second line of data found on absolute line number 7. Absolute line numbers must be specified in ascending order.

```
01 PAGE-HEADER TYPE IS PAGE HEADING.  
02 LINE IS 5.  
.  
.  
02 LINE IS 7.
```

In the following example the term PLUS in the LINE clause indicates that DETAIL-LINE prints two lines after the last line of the previous report group. If you used a CONTROL HEADING report group that ended on line 20 before DETAIL-LINE, then DETAIL-LINE would print beginning on line 22.

```
01 DETAIL-LINE TYPE IS DETAIL.  
02 LINE PLUS 2.
```

In the following example the LINE clause specifies that the REPORT FOOTING report group prints on line 32 of the next page:

```
01 REPORT-FOOTER TYPE IS REPORT FOOTING.  
02 LINE IS 32 ON NEXT PAGE.
```

You can code NEXT PAGE only for CONTROL HEADING, DETAIL, CONTROL FOOTING, and REPORT FOOTING groups, and only in the first LINE clause in that report group entry.

Within the report group, absolute line numbers must be in ascending order (although not consecutive) and must precede all relative line numbers.

You can use the NEXT GROUP clause instead of the LINE clause to control line spacing. In NEXT GROUP clause, you specify the amount of vertical line space you want following one report group and before the next. You use this clause in the report group that will have the space following it, as shown in the following example:

```
01 CONTROL-HEADER TYPE IS CONTROL HEADING CONTROL-NAME-1  
NEXT GROUP PLUS 4.  
01 DETAIL-LINE TYPE IS DETAIL.
```

## Producing Printed Reports

### 10.8 Programming a Report Writer Report

This example indicates relative line use. The report group (DETAIL) immediately following this CONTROL HEADING report group will print on the fourth line after the CH's last print line.

You can also specify absolute line spacing with the NEXT GROUP clause. An absolute line example—NEXT GROUP IS 10—places the next report group on line 10 of the page. In addition you can use NEXT GROUP NEXT PAGE, which causes a page-eject to occur before the NEXT GROUP report group prints.

NEXT GROUP can be coded only for REPORT HEADING, CONTROL HEADING, DETAIL, CONTROL FOOTING, and PAGE FOOTING report groups, and only at the 01 level.

A PAGE FOOTING report group must not specify the NEXT PAGE phrase of the NEXT GROUP clause.

Both the LINE and NEXT GROUP clauses must adhere to the page parameters specified in the PAGE clause in the RD entry.

In addition, the Report Writer facility keeps track of the number of lines printed or skipped on each page by using the LINE-COUNTER, which references a special register that the compiler generates for each Report Description entry in the Report Section. The Report Writer facility maintains the value of LINE-COUNTER and uses this value to determine the vertical positioning of a report.

#### 10.8.6 Horizontal Spacing for the Logical Page

The COLUMN NUMBER clause defines the horizontal location of items within a report line.

You use the COLUMN NUMBER clause only at the elementary level. This clause must appear in or be subordinate to an entry that contains a LINE NUMBER clause. Within the description of a report line, the COLUMN NUMBER clauses must show values in ascending column order. Column numbers must be positive integer literals with values from 1 to the maximum number of print positions on the printer. For example:

```
01      DETAIL-LINE
        TYPE DETAIL
        LINE PLUS 1.
        02 COLUMN 1      PIC X(15)          SOURCE LAST-NAME.
        02 COLUMN 17     PIC X(10)          SOURCE FIRST-NAME.
        02 COLUMN 28     PIC XX             SOURCE MIDDLE-INIT.
        02 COLUMN 40     PIC X(20)          SOURCE ADDRESS.
        02 COLUMN 97     PIC $$$,$$$,$$$.$99 SOURCE INVOICE-SALES.
```

Omitting the COLUMN clause creates a null (nonprinting) report item. Null report items are used to accumulate totals and force control breaks as described in Section 10.8.4.

The following example shows the use of a COLUMN NUMBER clause in a LINE clause:

```
02 LINE 15 COLUMN 1 PIC X(12) VALUE "SALES TOTALS".
```

The previous example results in the following output:

```
column 1234567890123456789012345678901234567890
        1           2           3           4
        SALES TOTALS
```

## Producing Printed Reports

### 10.8 Programming a Report Writer Report

In the next example, the COLUMN NUMBER clauses are subordinate to a LINE NUMBER clause:

```
02 LINE 5 ON NEXT PAGE.
03   COLUMN 1 PIC X(12)      VALUE "(Cust-Number".
03   COLUMN 14 PIC 9999      SOURCE CUST-NUM.
03   COLUMN 18 PIC X         VALUE ")".
03   COLUMN 20 PIC X(15)     VALUE "TOTAL PURCHASES".
03   COLUMN 36 PIC $$$$,$$$.$99 SUM TOT-PURCHS.
```

The previous example produces the following output:

```

           1           2           3           4
column 1234567890123456789012345678901234567890123456
      (Cust-Number 1234) TOTAL PURCHASES   $1,432.99
```

#### 10.8.7 Assigning a Value in a Print Line

In a Report Writer program, one way you specify a value for an item is to use the VALUE clause. This clause designates that the data item has a constant literal value. You often use this clause with REPORT HEADING and PAGE HEADING report groups, because the data in these groups is usually constant, as shown in the following example:

```
01   TYPE IS PAGE HEADING.
02   LINE 5.
03   COLUMN 1
      PIC X(27) VALUE "CUSTOMER MASTER FILE REPORT".
03   COLUMN 40
      PIC X(5)  VALUE "SALES".
```

The previous example results in the following output:

```

           1           2           3           4           5
column 12345678901234567890123456789012345678901234567890
      CUSTOMER MASTER FILE REPORT                SALES
```

#### 10.8.8 Defining the Source for a Print Field

To assign a variable value to an item in a Report Writer program, you use the SOURCE clause.

The SOURCE clause, written in the Report Section, is analogous to the MOVE statement.

The clause names a data item that is moved to a specified position on the print line. Before an item that contains a SOURCE clause is printed, the Report Writer moves the value in the field named in the SOURCE clause into the print line at the print position specified by the COLUMN clause, as shown in the following example. Any data editing specified by the PICTURE clause is performed before the data is moved to the print line.

```
01   DETAIL-LINE
      TYPE DETAIL
      LINE PLUS 1.
02   COLUMN 1 PIC X(15) SOURCE LAST-NAME.
02   COLUMN 17 PIC X(10) SOURCE FIRST-NAME.
02   COLUMN 28 PIC XX SOURCE MIDDLE-INIT.
02   COLUMN 35 PIC X(20) SOURCE ADDRESS.
02   COLUMN 55 PIC X(20) SOURCE CITY.
02   COLUMN 75 PIC XX SOURCE STATE.
02   COLUMN 78 PIC 99999 SOURCE ZIP.
```

## Producing Printed Reports

### 10.8 Programming a Report Writer Report

You can also code a SOURCE clause with PAGE-COUNTER or LINE-COUNTER as its operand, as the following example shows. PAGE-COUNTER references a special register created by the compiler for each Report Description entry in the Report Section. This counter automatically increments by 1 each time the Report Writer executes a page advance. The use of PAGE-COUNTER eliminates Procedure Division statements you normally would write to explicitly count pages, as shown in the following example:

```
01      TYPE IS PAGE HEADING.  
      02      LINE 5.  
          03      COLUMN 1  
              PIC X(27) VALUE "CUSTOMER MASTER FILE REPORT".  
          03      COLUMN 52  
              PIC X(4) VALUE "PAGE".  
          03      COLUMN 57  
              PIC ZZZ9  
              SOURCE PAGE-COUNTER.
```

This example produces the following output:

```
          1          2          3          4          5          6  
column 123456789012345678901234567890123456789012345678901234567890  
          CUSTOMER MASTER FILE REPORT                                PAGE 9
```

#### 10.8.9 Specifying Multiple Reports

To include two or more reports in one file, you specify multiple identifiers in the REPORTS clause and provide multiple RDs in the Report Section.

To identify the lines of two or more reports in one file, you use the CODE clause, as shown in the following example:

```
FILE SECTION.  
FD  REPORT-FILE  
    REPORTS ARE REPORT1  
                REPORT2  
                REPORT3.  
  
REPORT SECTION.  
RD  REPORT1...  
    CODE"AA".  
  
RD  REPORT2...  
    CODE"BB".  
  
RD  REPORT3...  
    CODE"CC".
```

The CODE clause specifies a 2-character nonnumeric literal that identifies each print line as belonging to a specific report. When the CODE clause is specified, the literal is automatically placed in the first two character positions of each Report Writer logical record. Note that if the clause is specified for any report in a file, it must be used for all reports in that file.

#### 10.8.10 Generating and Controlling Report Headings and Footings

When you write a report that has control headings and/or footings, you must use the CONTROL clause to create control levels that determine subsequent headings and totals.

The CONTROL clause, found in the RD entry, names data items that indicate when control breaks occur. The CONTROL clause specifies the data items in major to minor order. You must define these CONTROL data items, or control names, in the Data Division, and reference them in the appropriate CONTROL HEADING and FOOTING report groups.

## Producing Printed Reports

### 10.8 Programming a Report Writer Report

When the value of a control name changes, a control break occurs. The Report Writer acknowledges this break only when you execute a `GENERATE` or `TERMINATE` statement for the report, which causes the information related to that `CONTROL` report group to be printed.

In the following example, the report defines two control totals (`MONTH-CONTRL` and `WEEK-CONTRL`) in the `CONTROL` clause. The source of these control totals is in an input file named `IN-FILE`. The file must be already sorted in ascending sequence by `MONTH-CONTRL` and `WEEK-CONTRL`. The Report Writer facility automatically monitors these fields in the input file for any changes. If a new record contains different data than the previous record read, Report Writer triggers a control break.

```
FD   IN-FILE.
01   INPUT-RECORD.
      02 MONTH-CONTRL   PIC...
      02 ...
      02 ...
      02 WEEK-CONTRL   PIC...
FD   REPORT-FILE   REPORT IS SALES-REPORT.
      .
      .
      .
REPORT SECTION.
RD   SALES-REPORT.
      CONTROLS ARE MONTH-CONTRL, WEEK-CONTRL.
01   DETAIL-LINE TYPE IS DETAIL.
01   TYPE IS CONTROL FOOTING MONTH-CONTRL.
01   TYPE IS CONTROL FOOTING WEEK-CONTRL.
```

In the previous example, if the value in `WEEK-CONTRL` changes, a break occurs and Report Writer processes the `CONTROL FOOTING WEEK-CONTRL` report group. If the value in `MONTH-CONTRL` changes, a break occurs and Report Writer processes both `CONTROL FOOTING` report groups, because a break in any control field implies a break in all lower-order control fields as well.

The same process occurs if you include similar `CONTROL HEADING` report groups. However, `CONTROL HEADING` control breaks occur from a break to minor levels, while `CONTROL FOOTING` control breaks occur from a break to major levels.

The following example demonstrates the use of `FINAL`, a special control field that names the most major control field. You specify `FINAL` once, in the `CONTROL` clause, as the most major control level. When you code `FINAL`, a `FINAL` control break and subsequent `FINAL` headings and footings occur during program execution: once at the beginning of the report (as part of the report group, `CONTROL HEADING FINAL`), before the first detail line is printed; and once at the end of the report (as part of the report group, `CONTROL FOOTING FINAL`), after the last detail line is printed.

```
01   TYPE CONTROL FOOTING FINAL.
      02 LINE 58.
          04 COLUMN 1 PIC X(32) VALUE
              "TOTAL SALES FOR YEAR-TO-DATE WAS".
          04 COLUMN 45 PIC 9(6).99 SOURCE TOTAL-SALES.
```



## Producing Printed Reports

### 10.8 Programming a Report Writer Report

#### 10.8.11.2 Crossfooting

In crossfooting, the SUM clause adds all the sum counters in the same CONTROL FOOTING report group and automatically creates another sum counter.

In the following example, the CONTROL FOOTING group shows both subtotalling (SALES-1) and crossfooting (SALES-2):

```
01 TYPE DETAIL LINE PLUS 1.
   05 COLUMN 15 PIC 999.99 SOURCE BRANCH1-SALES.
   05 COLUMN 25 PIC 999.99 SOURCE BRANCH2-SALES.

01 TYPE CONTROL FOOTING BRANCH-TOTAL LINE PLUS 2.
   05 SALES-1 COLUMN 15 PIC 999.99 SUM BRANCH1-SALES.
   05 SALES-2 COLUMN 25 PIC 999.99 SUM BRANCH2-SALES.
   05 SALES-TOT COLUMN 50 PIC 999.99 SUM SALES-1, SALES-2.
```

The SALES-1 sum contains the total of the BRANCH1-SALES column and the SALES-2 sum contains the total of the BRANCH2-SALES column (both sums are subtotals). SALES-TOT contains the sum of SALES-1 and SALES-2; it is a crossfooting.

The crossfooting output is as follows:

	1	2	3	4	5	6
column 123456789012345678901234567890123456789012345678901234567890						
		125.00	300.00		425.00	

#### 10.8.11.3 Rolling Forward

When rolling totals forward, the SUM clause adds a sum counter from a lower-level CONTROL FOOTING report group to a sum counter in a higher-level footing group. The control logic and necessary control hierarchy for rolling counters forward begins in the CONTROL clause.

In the following example, WEEK-AMT is a sum counter found in the lower-level CONTROL FOOTING group, EACH-WEEK. This sum counter is named in the SUM clause in the higher-level CONTROL FOOTING report group, EACH-MONTH. The value of each WEEK-AMT sum is added to the higher-level counter just before the lower-level CONTROL FOOTING group is printed.

```
RD EXPENSE-FILE.
.
.
.
CONTROLS ARE EACH-MONTH, EACH-WEEK.
01 TYPE CONTROL FOOTING EACH-WEEK.
   02 LINE PLUS 2.
     03 COLUMN 1 PIC IS X(30)
       VALUE IS "TOTAL EXPENSES FOR WEEK/ENDING".
     03 COLUMN 33 PIC IS X(9) SOURCE IS MONTH.
     03 COLUMN 42 PIC IS X(2) SOURCE IS DAY.
     03 WEEK-AMT COLUMN 45
       PIC ZZ9.99 SUM COST.

01 TYPE CONTROL FOOTING EACH-MONTH.
   02 LINE PLUS 2.
     03 COLUMN 10 PIC X(18) VALUE IS "TOTAL EXPENSES FOR".
     03 COLUMN 29 PIC X(9) SOURCE MONTH.
     03 COLUMN 50 PIC ZZ9.99 SUM WEEK-AMT.
```

The following output is a result of rolling the totals forward:

	1	2	3	4	5
column 1234567890123456789012345678901234567890123456789012345					
TOTAL EXPENSES FOR DECEMBER				379.19	



**10.8.11.4 RESET Option**

When a CONTROL FOOTING group is printed, the SUM counter in that group is automatically reset to zero. If you want to specify when a SUM counter is reset to zero, use the RESET phrase. RESET names a data item in a higher-level CONTROL FOOTING that will cause the SUM counter to be reset to zero. RESET is used only with a SUM clause.

The following example sums SALES, resetting the counter to zero only when it encounters a new year (YEAR). This prevents the sum from being reset to zero when a new month causes a control break, giving a running total of the months within the year.

```
RD  SALES-REPORT.
    .
    .
    CONTROLS ARE YEAR, EACH-MONTH, EACH-WEEK.
    .
    .
01  TYPE CONTROL FOOTING EACH-MONTH
    02  COLUMN 10  PIC ZZ9.99  SUM SALES RESET ON YEAR.
```

**10.8.11.5 UPON Option**

Another SUM option is the UPON phrase. This phrase allows selective subtotalling for the DETAIL Report Group named in the phrase. When you use the UPON phrase, you cannot reference the sum counter in the SUM clause. You can use any File or Working-Storage Section elementary numeric data item.

When you code the UPON option with the SUM clause, the value of the data items of the SUM clause will be added whenever the TYPE DETAIL report group you name in the UPON option is generated.

```
WORKING-STORAGE SECTION.
    .
    .
01  WORK-AREA.
    .
    .
    03  ADD-COUNTER          PIC 9      VALUE 1.

REPORT SECTION.
    .
    .
01  FIRST-DETAIL-LINE TYPE IS DETAIL LINE IS PLUS 2.
    .
    .
01  TYPE IS CONTROL FOOTING FINAL.
    05  LINE IS PLUS 3.
    .
    .
    05  LINE PLUS 2.
       10  COLUMN 5          PIC Z(3)9  SUM ADD-COUNTER
                               UPON FIRST-DETAIL-LINE.
```

## Producing Printed Reports

### 10.8 Programming a Report Writer Report

In the preceding example, the value of ADD-COUNTER is added to the CONTROL FOOTING FINAL counter every time the FIRST-DETAIL-LINE report group is generated.

#### 10.8.12 Restricting Print Items

In a Report Writer program, the GROUP INDICATE clause eliminates repeated information from report detail lines by allowing an elementary item in a DETAIL report group to be printed only the first time after a control or page break. The following example illustrates the use of this clause:

```
01  DETAIL-LINE TYPE DETAIL LINE PLUS 1.
    05  COLUMN 1 GROUP INDICATE PIC X(6) VALUE "SALES:".
*      (prints only the first time after a control or page break)
    05  COLUMN 10 PIC X(10) SOURCE BRANCH.
*      (prints each time)
```

These statements produce the following lines:

```
SALES:  BRANCH-A
        BRANCH-B
        BRANCH-C
```

The next two examples are nearly identical programs; the only difference is the use of the GROUP INDICATE clause in the second example.

The following program does not contain a GROUP INDICATE clause:

```
01  DETAIL-LINE TYPE IS DETAIL
    LINE IS PLUS 1.
02  COLUMN 1 PIC X(15)
    SOURCE A-NAME.
02  COLUMN 20 PIC 9(6)
    SOURCE A-REG-NO.
```

It produces the following output:

1	2	3
1234567890	1234567890	1234567890
Name	Registration	Number
Rolans R.	123456	
Rolans R.	123457	
Rolans R.	123458	
Vencher R.	654321	
Vencher R.	654322	
Vencher R.	654323	
Vencher R.	654324	
Anders J.	987654	
Anders J.	987655	
Anders J.	987656	

The following example contains a GROUP INDICATE clause:

```
01  DETAIL-LINE TYPE IS DETAIL
    LINE IS PLUS 1.
02  COLUMN 1 PIC X(15)
    SOURCE A-NAME
    GROUP INDICATE.
02  COLUMN 20 PIC 9(6)
    SOURCE A-REG-NO.
```

## Producing Printed Reports

### 10.8 Programming a Report Writer Report

With the GROUP INDICATE clause, the program produces the following output:

	1	2	3
	1234567890	1234567890	1234567890
Name		Registration	
		Number	
Rolans R.		123456	
		123457	
		123458	
Vencher R.		654321	
		654322	
		654323	
		654324	
Anders J.		987654	
		987655	
		987656	

#### 10.8.13 Processing a Report Writer Report

In a Report Writer program, you usually use the following five statements:

- INITIATE
- GENERATE
- TERMINATE
- USE BEFORE REPORTING
- SUPPRESS

You must use the INITIATE, GENERATE, and TERMINATE statements. The USE BEFORE REPORTING and the SUPPRESS statements are optional.

Before any Report Writer statement is executed, the report file must be open.

##### 10.8.13.1 Initiating the Report

The INITIATE statement begins the report processing and is executed before any GENERATE or TERMINATE statements. The report name used in this statement is specified in the RD entry in the Report Section and in the REPORT clause of the FD entry for the file to which the report is written.

INITIATE sets PAGE-COUNTER to 1, LINE-COUNTER to zero, and all SUM counters to zero.

This program code uses the code in Section 10.8.2.

```
PROCEDURE DIVISION.  
.  
.  
.  
MAIN SECTION.  
000-START.  
    OPEN INPUT CUSTOMER-FILE.  
    OPEN OUTPUT PRINTER-FILE.  
    .  
    .  
    .  
    INITIATE MASTER-LIST.
```

A second INITIATE statement for the same report must not be executed until a TERMINATE statement for the report has been executed (see Section 10.8.13.4).

# Producing Printed Reports

## 10.8 Programming a Report Writer Report

### 10.8.13.2 Generating a Report Writer Report

The GENERATE statement prints the report.

You can produce either detail or summary reports depending on the GENERATE identifier. If you code the name of a DETAIL report group with GENERATE, you create a detail report; if you code a report name with GENERATE, you create a summary report.

### 10.8.13.3 Automatic Operations of the GENERATE Statement

When the first GENERATE statement is executed, the following report groups are printed, if they are specified in the program:

- REPORT HEADING report group
- PAGE HEADING report group
- CONTROL HEADING report groups
- For detail reporting, the specified TYPE DETAIL report group

A USE BEFORE REPORTING declarative can also execute just before the associated report group is produced, to produce a cover page for the report, for example.

---

#### Note

---

Figure 10–11 and Figure 10–12 illustrate the major flow of operations, but do not cover all possible operations associated with a GENERATE statement.

---

Figure 10–11 shows the sequence of operations for the first GENERATE statement.

**Figure 10–11 First GENERATE Statement**

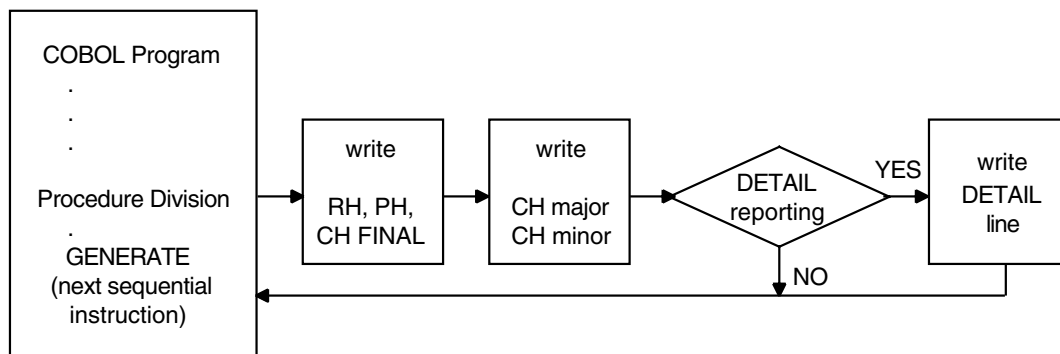

ZK-1552-GE

For subsequent GENERATE statements in the program, the following operations take place:

- Any USE BEFORE REPORTING declaratives execute just before the associated report group is produced.
- Any specified control breaks occur.

## Producing Printed Reports 10.8 Programming a Report Writer Report

- CONTROL FOOTING and CONTROL HEADING report groups print after the specified control breaks occur.
- In a detail report, the TYPE DETAIL report groups print.
- SUM operands are incremented.
- Sum counters are reset as specified.

Figure 10–12 shows the sequence of operations for all GENERATE statements except the first. See Figure 10–11 for a comparison with the sequence of operations for the first GENERATE statement.

**Figure 10–12 Subsequent GENERATE Statements**

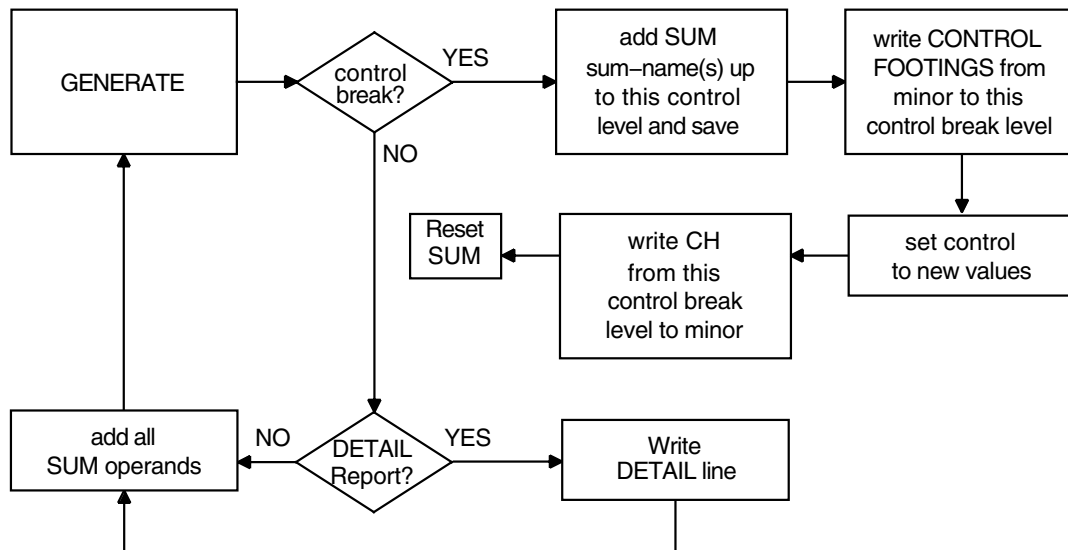

ZK-1553-GE

### 10.8.13.4 Ending Report Writer Processing

The TERMINATE statement completes the processing of a report.

Like INITIATE, the TERMINATE statement report name is specified in the RD entry in the Report Section and in the REPORT clause of the FD entry for the file to which the report is written.

When the TERMINATE statement is executed, breaks occur for all control fields, and all control footings are written; any page footings and report footings are also written.

```

PROCEDURE DIVISION.
.
.
.
300-END-OF-FILE.
  TERMINATE MASTER-LIST.
  CLOSE CUSTOMER-FILE, PRINTER-FILE.
  STOP RUN.
  
```

## Producing Printed Reports

### 10.8 Programming a Report Writer Report

If no `GENERATE` statement has been executed for the report, the `TERMINATE` statement does not produce any report groups.

A second `TERMINATE` statement for the report must not be executed before a second `INITIATE` statement for the report has been executed.

The `TERMINATE` statement does not close the report file; a `CLOSE` statement must be executed after the `TERMINATE` statement.

Figure 10–13 shows the sequence of operations for `TERMINATE`.

**Figure 10–13** `TERMINATE` Statement

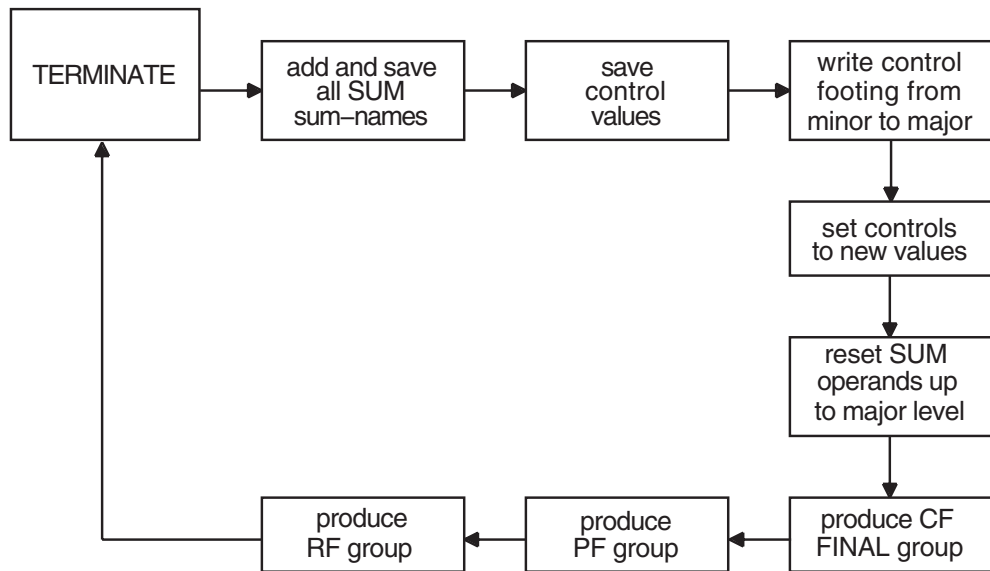

ZK-1554-GE

#### 10.8.13.5 Applying the `USE BEFORE REPORTING` Statement

In a COBOL program, you specify a Declarative section to define procedures that supplement the standard procedures of the program. Note that in a Report Writer program, you can specify the `USE BEFORE REPORTING` statement. This `USE BEFORE REPORTING` statement gives you more control over the data to be printed in a Report Writer program.

The `USE BEFORE REPORTING` statement:

- Allows you to define declarative procedures
- Causes those procedures to be executed just before a specified report group is printed (this specified report group name is written with the `USE` statement)
- Lets you modify the data to be printed (for example, where simple sum operations must be augmented by more complex operations involving multiplication, division, and subtraction)
- Lets you suppress printing the report group

## Producing Printed Reports

### 10.8 Programming a Report Writer Report

The following example indicates that the phrase BEGINNING-OF-REPORT is to be displayed just before the REPORT HEADING group named REPORT-HEADER; the phrase END-OF-REPORT is to be displayed just before the REPORT FOOTING group called REPORT-FOOTER.

```
PROCEDURE DIVISION.  
DECLARATIVES.  
BOR SECTION.  
    USE BEFORE REPORTING REPORT-HEADER.  
BOR-A.  
    DISPLAY "BEGINNING-OF-REPORT".  
EOR SECTION.  
    USE BEFORE REPORTING REPORT-FOOTER.  
EOR-A.  
    DISPLAY "END-OF-REPORT".  
END DECLARATIVES.
```

Note that you cannot use INITIATE, GENERATE, or TERMINATE in a Declarative procedure.

#### 10.8.13.6 Suppressing a Report Group

You can also use the SUPPRESS statement in a USE BEFORE REPORTING procedure to suppress the printing of a report group. For example, you can suppress printing of an unnecessary total line, such as a line for a monthly sales total that has only one sale or a line of zeros.

The SUPPRESS statement nullifies any NEXT GROUP and LINE clauses, but leaves the LINE-COUNTER value unchanged.

Note that the SUPPRESS statement applies only to that particular instance of the report group; that group will be printed the next time unless the SUPPRESS statement is executed again.

The SUPPRESS statement has no effect on sum counters.

#### 10.8.14 Selecting a Report Writer Report Type

You can print two types of reports using the Report Writer feature. In a detail report, you print primary data information as well as totals. In a summary report, you print only control heading and footing information (such as report data headings and totals) and exclude detail input record information.

Section 10.9 provides examples of detail and summary reports.

##### 10.8.14.1 Detail Reporting

In detail reporting, at least one printable TYPE DETAIL report group must be specified. A GENERATE statement produces the specified TYPE DETAIL report group and performs all the automatic operations of the Report Writer facility as specified in the report group entries (see Section 10.8.13.3).

In the following example, DETAIL-LINE is the name of the DETAIL report group. When this GENERATE statement executes, a detail report is printed.

```
200-READ-MASTER.  
    READ CUSTOMER-FILE AT END MOVE HIGH-VALUES TO NAME.  
    IF NAME NOT = HIGH-VALUES GENERATE DETAIL-LINE.
```

## Producing Printed Reports

### 10.8 Programming a Report Writer Report

#### 10.8.14.2 Summary Reporting

In summary reporting, the `GENERATE` statement performs all of the automatic operations of the Report Writer facility, but does not produce any `TYPE DETAIL` report groups.

A report name references the name of an RD entry. If `MASTER-LIST` is an RD entry, then `GENERATE MASTER-LIST` produces `HEADING` and `FOOTING` report groups (in the order defined), but omits `DETAIL` report group lines.

## 10.9 Report Writer Examples

This section provides you with the input data and sample reports produced by five Report Writer programs. Each sample report has a program summary section that describes the Report Writer features used in that program; you can examine the summary and output to determine the usage of Report Writer features. Note that each sample report is followed by the program that was used to generate it.

Also, many of the report pages in Reports 2 through 5 have been compressed into fewer pages than you would normally find. For example, a report title page is typically found on a separate page. Whether you are producing a report for yourself or for a customer, you must begin by designing the report.

---

#### Note

---

On OpenVMS, the Report Writer facility produces a report file in print-file format. When Report Writer positions the file at the top of the next logical page, it positions the pointer by line spacing, rather than page ejection or form feed.

The default OpenVMS `PRINT` command inserts a form-feed character when a form is within four lines of the bottom. Therefore, when the default `PRINT` command refers to a Report Writer file, unexpected page spacing can result.

The `/NOFEED` file qualifier of the `PRINT` command suppresses the insertion of form-feed characters and prints Report Writer files correctly. Consequently, you should use the `/NOFEED` qualifier when you use the Report Writer facility to print a report on OpenVMS. ♦

---

### 10.9.1 Input Data

The data records shown in Figure 10–14 are used for the programs in this section.



Figure 10–14 Sample MASTER.DAT File

Abbott	John	B12 Pleasant Street	Nashua	NH0310212340000001100009007012000
Adam	Harold	B980 Main Street	Nashua	NH0310223410000002210089002062000
Albert	Robert	S100 Meadow Lane	Gardner	MA0142012340000003610090002062000
Alexander	Greg	T317 Narrows Road	Westminster	MA0147334160000004100007102062000
Abbott	John	B12 Pleasant Street	Nashua	NH0310212340000001100009007012000
Allan	David	L10 Wonder Lane	Merrimack	NH0301467800000001241010002062000
Amos	James	A71 State Rd	East Westminster	MA0147312341000006410009002062000
Amico	Art	A31 Athens Road	Nashua	NH0306089000000007123407002062000
Abbott	John	B12 Pleasant Street	Nashua	NH0310212340000001100009007012000
Ames	Alice	J40 Center Road	Nashua	NH030607890000000710000002072000
Alwin	Tom	F400 High Street	Princeton	NJ1234112341000008700001703072000
Alexander	Greg	T317 Narrows Road	Westminster	MA0147334160000004100007102062000
Berger	Tom	H700 McDonald Lane	Merrimack	NH0306012341000010123416002062000
Abbott	John	B12 Pleasant Street	Nashua	NH0310212340000001100009007012000
Ames	Alice	J40 Center Road	Nashua	NH030607890000000710000002072000
Carter	Winston	R123 Timpany Street	Brookline	NH0307823416000011234167602072000
Alexander	Greg	T317 Narrows Road	Westminster	MA0147334160000004100007102062000
Carroll	Alice	L192 Lewis Road	London	NH0341611117000012167890002072000
Abbott	John	B12 Pleasant Street	Nashua	NH0310212340000001100009007012000
Hemingway	Joe	E10 Cuba Street	Westminster	MA0147312341000013876900002072000
Cooper	Frank	J300 Mohican Avenue	Mohawk	MA0148034167000014341678002072000
Alexander	Greg	T317 Narrows Road	East Westminster	MA0147334160000004100007102062000
Dickens	Arnold	C100 Bleak Street	Gardner	MA0144090000000011123416702072000
Thoreaux	Ralph	H800 Emerson Street	Walden	MA0141641678000016000060002072000
Abbott	John	B12 Pleasant Street	Nashua	NH0310212340000001100009007012000
Williams	Samuel	A310 England Road	Worcester	MA014001234100001778900002072000
Alexander	Greg	T317 Narrows Road	Westminster	MA0147334160000004100007102062000
Ames	Alice	J40 Center Road	Nashua	NH030607890000000710000002072000
Dickinson	Rose	E21 Depot Road	Amherst	MA0142341678000019666889002072000
Frost	Alfred	R123 Amherst Street	Merrimack	NH0306012341000020111149002072000
Alexander	Greg	T317 Narrows Road	East Westminster	MA0147334160000004100007102062000
Abbott	John	B12 Pleasant Street	Nashua	NH0310212340000001100009007012000

VM-0698A-AI

## 10.9.2 EX1006—Detail Report Program

EX1006 uses the PAGE HEADING, DETAIL, and CONTROL FOOTING report groups and produces a detail report—EX1006.LIS.

To get EX1006.LIS, you use the following commands:

On OpenVMS

```
$ COBOL EX1006
$ LINK EX1006
$ RUN EX1006
$ PRINT/NOFEED EX1006.LIS
```

Note that the case of the command parameters is insignificant in the preceding command example.

On Tru64 UNIX

```
% cobol ex1006.cob
% a.out
% lpr EX1006.LIS
```

Note that the case of the file name, EX1006.LIS, is significant in the preceding command example, because the file specification in the ASSIGN statement in Example 10–6 was given in upper case. The program (EX1006) in Example 10–6 produces the output shown in Figure 10–15 (EX1006.LIS).

# Producing Printed Reports

## 10.9 Report Writer Examples

### Example 10-6 Sample Program EX1006

```
IDENTIFICATION DIVISION.
PROGRAM-ID. EX1006.
ENVIRONMENT DIVISION.
CONFIGURATION SECTION.
INPUT-OUTPUT SECTION.
FILE-CONTROL.
    SELECT CUSTOMER-FILE ASSIGN TO "MASTER.DAT".
    SELECT SORT-FILE      ASSIGN TO "EX1006-SORTIN.TMP".
    SELECT SORTED-FILE    ASSIGN TO "EX1006-SORTOUT.TMP".
    SELECT PRINTER-FILE  ASSIGN TO "EX1006.LIS".

DATA DIVISION.
FILE SECTION.
SD    SORT-FILE.
01    SORTED-CUSTOMER-MASTER-FILE.
      02 SORT-NAME                PIC X(26).
      02                                PIC X(73).
      FD    CUSTOMER-FILE.
01    CUSTOMER-MASTER-FILE        PIC X(99).
FD    SORTED-FILE.

01    CUSTOMER-MASTER-FILE.
      02 NAME.
          03 LAST-NAME            PIC X(15).
          03 FIRST-NAME           PIC X(10).
          03 MIDDLE-INIT          PIC X.
      02 ADDRESS                  PIC X(20).
      02 CITY                    PIC X(20).
      02 STATE                   PIC XX.
      02 ZIP                     PIC 99999.
      02 SALESMAN-NUMBER         PIC 99999.
          02 INVOICE-DATA.
              03 INVOICE-NUMBER   PIC 999999.
              03 INVOICE-SALES   PIC S9(5)V99.
              03 INVOICE-DATE.
                  04 INV-DAY      PIC 99.
                  04 INV-MO       PIC 99.
                  04 INV-YR       PIC 9999.

FD    PRINTER-FILE
      REPORT IS MASTER-LIST.

WORKING-STORAGE SECTION.
01    UNEDITED-DATE.
      02 UE-YEAR                 PIC 9999.
      02 UE-MONTH               PIC 99.
      02 UE-DAY                 PIC 99.
      02 FILLER                 PIC X(6).
01    ONE-COUNT                 PIC 9 VALUE 1.
```

(continued on next page)

**Example 10–6 (Cont.) Sample Program EX1006**

REPORT SECTION.

```

RD      MASTER-LIST
        PAGE LIMIT IS 66
        HEADING      1
        FIRST DETAIL 13
        LAST DETAIL  55
        CONTROL IS FINAL.
01      TYPE IS PAGE HEADING.
        02          LINE 5.
            03      COLUMN 1
                PIC X(27) VALUE "CUSTOMER MASTER FILE REPORT".
            03      COLUMN 105
                PIC X(4)  VALUE "PAGE".
            03      COLUMN 109
                PIC ZZZ9
                SOURCE PAGE-COUNTER.
            02      LINE 7.
            03      COLUMN 1
                PIC X VALUE "+".
            03      COLUMN 2
                PIC X(110) VALUE ALL "-".
            03      COLUMN 112
                PIC X VALUE "+".
        02      LINE 8.
            03      COLUMN 1
                PIC X VALUE "|".
            03      COLUMN 10
                PIC X(4) VALUE "NAME".
            03      COLUMN 29
                PIC X VALUE "|".
            03      COLUMN 43
                PIC X(7) VALUE "ADDRESS".
            03      COLUMN 81
                PIC X VALUE "|".
            03      COLUMN 91
                PIC X(7) VALUE "INVOICE".
            03      COLUMN 112
                PIC X VALUE "|".
            02      LINE 9.
            03      COLUMN 1
                PIC X VALUE "|".
            03      COLUMN 2
                PIC X(110) VALUE ALL "-".
            03      COLUMN 112
                PIC X VALUE "|".
        02      LINE 10.
            03      COLUMN 1
                PIC X(6) VALUE "| LAST".
            03      COLUMN 16
                PIC X(7) VALUE "| FIRST".
            03      COLUMN 26
                PIC X(4) VALUE "|MI|".
            03      COLUMN 35
                PIC X(6) VALUE "STREET".
            03      COLUMN 48
                PIC X VALUE "|".

```

(continued on next page)

# Producing Printed Reports

## 10.9 Report Writer Examples

### Example 10-6 (Cont.) Sample Program EX1006

```

03     COLUMN 52
        PIC X(4) VALUE "CITY".
03     COLUMN 71
        PIC X VALUE "|".
03     COLUMN 72
        PIC X(2) VALUE "ST".
03     COLUMN 74
        PIC X VALUE "|".
03     COLUMN 81
        PIC X VALUE "|".
03     COLUMN 83
        PIC X(4) VALUE "DATE".
03     COLUMN 90
        PIC X VALUE "|".
03     COLUMN 92
        PIC X(6) VALUE "NUMBER".
03     COLUMN 98
        PIC X VALUE "|".
03     COLUMN 103
        PIC X(6) VALUE "AMOUNT".
03     COLUMN 112
        PIC X VALUE "|".
02     LINE 11.
03     COLUMN 1
        PIC X VALUE "+".
03     COLUMN 2
        PIC X(110) VALUE ALL "-".
03     COLUMN 112
        PIC X VALUE "+".
01     DETAIL-LINE
        TYPE DETAIL
        LINE PLUS 1.
02     COLUMN 1     PIC X(15) SOURCE LAST-NAME.
02     COLUMN 17    PIC X(10) SOURCE FIRST-NAME.
02     COLUMN 28    PIC XX   SOURCE MIDDLE-INIT.
02     COLUMN 30    PIC X(20) SOURCE ADDRESS.
02     COLUMN 51    PIC X(20) SOURCE CITY.
02     COLUMN 72    PIC XX   SOURCE STATE.
02     COLUMN 75    PIC 99999 SOURCE ZIP.
02     COLUMN 81    PIC Z9   SOURCE INV-DAY.
02     COLUMN 83    PIC X    VALUE "-".
02     COLUMN 84    PIC 99   SOURCE INV-MO.
02     COLUMN 86    PIC X    VALUE "-".
02     COLUMN 87    PIC 9999 SOURCE INV-YR.
02     COLUMN 92    PIC 9(6) SOURCE INVOICE-NUMBER.
02     COLUMN 99    PIC $$$,$$$,$$$.$99-
                    SOURCE INVOICE-SALES.
02     DETAIL-COUNT PIC S9(10) SOURCE ONE-COUNT.
02     INV-AMOUNT  PIC S9(9)V99 SOURCE INVOICE-SALES.
01     FINAL-FOOTING TYPE IS CONTROL FOOTING FINAL
        LINE PLUS 5
        NEXT GROUP NEXT PAGE.
02     COLUMN 20    PIC X(17) VALUE "TOTAL RECORDS: ".
02     FDC COLUMN 40 PIC ZZZ,ZZZ,ZZ9 SUM ONE-COUNT.
02     COLUMN 75    PIC X(15) VALUE "TOTAL SALES: ".
02     FIA COLUMN 95 PIC $$$,$$$,$$$,$$$.$99- SUM INVOICE-SALES.

```

(continued on next page)

# Producing Printed Reports 10.9 Report Writer Examples

## Example 10-6 (Cont.) Sample Program EX1006

```

PROCEDURE DIVISION.
000-DO-SORT.
    DISPLAY "*** EX1006 ***".
    SORT SORT-FILE ON ASCENDING KEY SORT-NAME
      WITH DUPLICATES IN ORDER
      USING CUSTOMER-FILE
      GIVING SORTED-FILE.
    DISPLAY "*** Created EX1006.LIS ***".

050-START.
    OPEN INPUT  SORTED-FILE.
    OPEN OUTPUT PRINTER-FILE.
    ACCEPT UNEDITED-DATE FROM DATE.
    INITIATE MASTER-LIST.
    PERFORM 200-READ-MASTER UNTIL NAME = HIGH-VALUES.

100-END-OF-FILE.
    TERMINATE MASTER-LIST.
    CLOSE SORTED-FILE, PRINTER-FILE.
    STOP RUN.

200-READ-MASTER.
    READ SORTED-FILE AT END MOVE HIGH-VALUES TO NAME.
    IF NAME NOT = HIGH-VALUES GENERATE DETAIL-LINE.
  
```

**Figure 10-15 EX1006.LIS Listing**

CUSTOMER MASTER FILE REPORT									PAGE	1	
NAME			ADDRESS			INVOICE					
LAST	FIRST	MI	STREET	CITY	ST	DATE	NUMBER	AMOUNT			
Abbott	John	B	12 Pleasant Street	Nashua	NH 03102	7-01-2000	000001	\$10,000.90			
Abbott	John	B	12 Pleasant Street	Nashua	NH 03102	7-01-2000	000001	\$10,000.90			
Abbott	John	B	12 Pleasant Street	Nashua	NH 03102	7-01-2000	000001	\$10,000.90			
Abbott	John	B	12 Pleasant Street	Nashua	NH 03102	7-01-2000	000001	\$10,000.90			
Abbott	John	B	12 Pleasant Street	Nashua	NH 03102	7-01-2000	000001	\$10,000.90			
Abbott	John	B	12 Pleasant Street	Nashua	NH 03102	7-01-2000	000001	\$10,000.90			
Abbott	John	B	12 Pleasant Street	Nashua	NH 03102	7-01-2000	000001	\$10,000.90			
Adam	Harold	B	980 Main Street	Nashua	NH 03102	2-06-2000	000002	\$21,008.90			
Albert	Robert	S	100 Meadow Lane	Gardner	MA 01420	2-06-2000	000003	\$61,009.00			
Alexander	Greg	T	317 Narrows Road	Westminster	MA 01473	2-06-2000	000004	\$10,000.71			
Alexander	Greg	T	317 Narrows Road	Westminster	MA 01473	2-06-2000	000004	\$10,000.71			
Alexander	Greg	T	317 Narrows Road	Westminster	MA 01473	2-06-2000	000004	\$10,000.71			
Alexander	Greg	T	317 Narrows Road	East Westminster	MA 01473	2-06-2000	000004	\$10,000.71			
Alexander	Greg	T	317 Narrows Road	East Westminster	MA 01473	2-06-2000	000004	\$10,000.71			
Allan	David	L	10 Wonder Lane	Merrimack	NH 03014	2-06-2000	000001	\$24,101.00			
Alwin	Tom	F	400 High Street	Princeton	NJ 12341	3-07-2000	000008	\$70,000.17			
Ames	Alice	J	40 Center Road	Nashua	NH 03060	2-07-2000	000007	\$10,000.00			
Ames	Alice	J	40 Center Road	Nashua	NH 03060	2-07-2000	000007	\$10,000.00			
Ames	Alice	J	40 Center Road	Nashua	NH 03060	2-07-2000	000007	\$10,000.00			
Amico	Art	A	31 Athens Road	Nashua	NH 03060	2-06-2000	000007	\$12,340.70			
Amos	James	A	71 State Rd	East Westminster	MA 01473	2-06-2000	000006	\$41,000.90			
Berger	Tom	H	700 McDonald Lane	Merrimack	NH 03060	2-06-2000	000010	\$12,341.60			
Carroll	Alice	L	192 Lewis Road	London	NH 03416	2-07-2000	000012	\$16,789.00			
Carter	Winston	R	123 Timpany Street	Brookline	NH 03078	2-07-2000	000011	\$23,416.76			
Cooper	Frank	J	300 Mohican Avenue	Mohawk	MA 01480	2-07-2000	000014	\$34,167.80			
Dickens	Arnold	C	100 Bleak Street	Gardner	MA 01440	2-07-2000	000011	\$12,341.67			
Dickinson	Rose	E	21 Depot Road	Amherst	MA 01423	2-07-2000	000019	\$66,688.90			
Frost	Alfred	R	123 Amherst Street	Merrimack	NH 03060	2-07-2000	000020	\$11,114.90			
Hemingway	Joe	E	10 Cuba Street	Westminster	MA 01473	2-07-2000	000013	\$87,690.00			
Thoreaux	Ralph	H	800 Emerson Street	Walden	MA 01416	2-07-2000	000016	\$6.00			
Williams	Samuel	A	310 England Road	Worcester	MA 01400	2-07-2000	000017	\$78,900.00			
TOTAL RECORDS:					32	TOTAL SALES:			\$732,927.86		

VM-0660A-AI

## Producing Printed Reports

### 10.9 Report Writer Examples

#### 10.9.3 EX1007—Detail Report Program

Example 10–7 (EX1007) is a Report Writer program that uses the REPORT HEADING, PAGE HEADING, DETAIL, CONTROL FOOTING, and REPORT FOOTING report groups and produces a detail report—EX1007.LIS (shown in Figure 10–16). The output includes both subtotals and rolling-forward totals.

#### Example 10–7 Sample Program EX1007

```
IDENTIFICATION DIVISION.
PROGRAM-ID. EX1007.
ENVIRONMENT DIVISION.
CONFIGURATION SECTION.
INPUT-OUTPUT SECTION.
FILE-CONTROL.
    SELECT CUSTOMER-FILE ASSIGN TO "MASTER.DAT".
    SELECT SORT-FILE      ASSIGN TO "EX1007-SORTIN.TMP".
    SELECT SORTED-FILE    ASSIGN TO "EX1007-SORTOUT.TMP".
    SELECT PRINTER-FILE   ASSIGN TO "EX1007.LIS".
DATA DIVISION.
FILE SECTION.

SD      SORT-FILE.
01      SORTED-CUSTOMER-MASTER-FILE.
        02 SORT-NAME          PIC X(26).
        02                      PIC X(73).

FD      CUSTOMER-FILE.
01      CUSTOMER-MASTER-FILE          PIC X(99).

FD      SORTED-FILE.
01      CUSTOMER-MASTER-FILE.
        02 NAME.
            03 LAST-NAME          PIC X(15).
            03 FIRST-NAME         PIC X(10).
            03 MIDDLE-INIT        PIC X.
        02 ADDRESS                PIC X(20).
        02 CITY                   PIC X(20).
        02 STATE                  PIC XX.
        02 ZIP                    PIC 99999.
        02 SALESMAN-NUMBER        PIC 99999.
        02 INVOICE-DATA.
            03 INVOICE-NUMBER     PIC 999999.
            03 INVOICE-SALES      PIC S9(5)V99.
            03 INVOICE-DATE.
                04 INV-DAY        PIC 99.
                04 INV-MO         PIC 99.
                04 INV-YR         PIC 9999.

FD      PRINTER-FILE
REPORT IS MASTER-LIST.
WORKING-STORAGE SECTION.
01      UNEDITED-DATE.
        02 UE-YEAR                PIC 9999.
        02 UE-MONTH              PIC 99.
        02 UE-DAY                PIC 99.
        02 FILLER                PIC X(6).

01      ONE-COUNT                PIC 9 VALUE 1.
```

(continued on next page)

## Producing Printed Reports 10.9 Report Writer Examples

### Example 10-7 (Cont.) Sample Program EX1007

REPORT SECTION.

```
RD    MASTER-LIST
      PAGE LIMIT IS 66
      HEADING      1
      FIRST DETAIL 13
      LAST DETAIL  55
      CONTROLS ARE FINAL
                        NAME.
01    REPORT-HEADER TYPE IS REPORT HEADING NEXT GROUP NEXT PAGE.
02    LINE 24.
      03    COLUMN 45
           PIC X(31) VALUE ALL "*".
02    LINE 25.
      03    COLUMN 45
           PIC X VALUE "*".
      03    COLUMN 75
           PIC X VALUE "*".
02    LINE 26.
      03    COLUMN 45
           PIC X(31) VALUE "*" Customer Master File  "*".
02    LINE 27.
      03    COLUMN 45
           PIC X VALUE "*".
      03    COLUMN 75
           PIC X VALUE "*".
02    LINE 28.
      03    COLUMN 45
           PIC X VALUE "*".
      03    COLUMN 55
           PIC Z9
           SOURCE UE-DAY.
      03    COLUMN 57
           PIC X VALUE "-".
      03    COLUMN 58
           PIC 99
           SOURCE UE-MONTH.
      03    COLUMN 60
           PIC X VALUE "-".
      03    COLUMN 61
           PIC 9999
           SOURCE UE-YEAR.
      03    COLUMN 75
           PIC X VALUE "*".
02    LINE 29.
      03    COLUMN 45
           PIC X VALUE "*".
      03    COLUMN 75
           PIC X VALUE "*".
02    LINE 30.
      03    COLUMN 45
           PIC X(31) VALUE "*" Report EX1007  "*".
02    LINE 31.
      03    COLUMN 45
           PIC X(31) VALUE "*" Detail Report  "*".
```

(continued on next page)

## Producing Printed Reports

### 10.9 Report Writer Examples

#### Example 10-7 (Cont.) Sample Program EX1007

```
02      LINE 32.
03      COLUMN 45
        PIC X VALUE "*".
03      COLUMN 75
        PIC X VALUE "*".
02      LINE 33.
03      COLUMN 45
        PIC X VALUE "*".
03      COLUMN 75
        PIC X VALUE "*".
02      LINE 34.
03      COLUMN 45
        PIC X VALUE "*".
03      COLUMN 75
        PIC X VALUE "*".
02      LINE 35.
03      COLUMN 45
        PIC X(31) VALUE ALL "*".
01 TYPE IS PAGE HEADING.
02      LINE 5.
03      COLUMN 1
        PIC X(27) VALUE "CUSTOMER MASTER FILE REPORT".
03      COLUMN 105
        PIC X(4) VALUE "PAGE".
03      COLUMN 109
        PIC ZZZ9
        SOURCE PAGE-COUNTER.
02      LINE 7.
03      COLUMN 1
        PIC X VALUE "+".
03      COLUMN 2
        PIC X(110) VALUE ALL "-".
03      COLUMN 112
        PIC X VALUE "+".
02      LINE 8.
03      COLUMN 1
        PIC X VALUE "|".
03      COLUMN 10
        PIC X(4) VALUE "NAME".
03      COLUMN 29
        PIC X VALUE "|".
03      COLUMN 43
        PIC X(7) VALUE "ADDRESS".
03      COLUMN 81
        PIC X VALUE "|".
03      COLUMN 91
        PIC X(7) VALUE "INVOICE".
03      COLUMN 112
        PIC X VALUE "|".
```

(continued on next page)



Example 10-7 (Cont.) Sample Program EX1007

```
02     LINE  9.
      03     COLUMN  1
          PIC X VALUE "|".
      03     COLUMN  2
          PIC X(110) VALUE ALL "-".
      03     COLUMN 112
          PIC X VALUE "|".
02     LINE 10.
      03     COLUMN  1
          PIC X(6) VALUE "| LAST".
      03     COLUMN 16
          PIC X(7) VALUE "| FIRST".
      03     COLUMN 26
          PIC X(4) VALUE "|MI|".
      03     COLUMN 35
          PIC X(6) VALUE "STREET".
      03     COLUMN 48
          PIC X VALUE "|".
      03     COLUMN 52
          PIC X(4) VALUE "CITY".
      03     COLUMN 71
          PIC X VALUE "|".
      03     COLUMN 72
          PIC X(2) VALUE "ST".
      03     COLUMN 74
          PIC X VALUE "|".
      03     COLUMN 76
          PIC X(3) VALUE "ZIP".
      03     COLUMN 81
          PIC X VALUE "|".
      03     COLUMN 83
          PIC X(4) VALUE "DATE".
      03     COLUMN 90
          PIC X VALUE "|".
      03     COLUMN 92
          PIC X(6) VALUE "NUMBER".
      03     COLUMN 98
          PIC X VALUE "|".
      03     COLUMN 103
          PIC X(6) VALUE "AMOUNT".
      03     COLUMN 112
          PIC X VALUE "|".
02     LINE 11.
      03     COLUMN  1
          PIC X VALUE "+".
      03     COLUMN  2
          PIC X(110) VALUE ALL "-".
      03     COLUMN 112
          PIC X VALUE "+".
```

(continued on next page)

# Producing Printed Reports

## 10.9 Report Writer Examples

### Example 10-7 (Cont.) Sample Program EX1007

```

01  DETAIL-LINE
    TYPE DETAIL
    LINE PLUS 2.
    02 COLUMN 1      PIC X(15) SOURCE LAST-NAME.
    02 COLUMN 17     PIC X(10) SOURCE FIRST-NAME.
    02 COLUMN 28     PIC XX  SOURCE MIDDLE-INIT.
    02 COLUMN 30     PIC X(20) SOURCE ADDRESS.
    02 COLUMN 51     PIC X(20) SOURCE CITY.
    02 COLUMN 72     PIC XX  SOURCE STATE.
    02 COLUMN 75     PIC 99999 SOURCE ZIP.
    02 COLUMN 81     PIC Z9  SOURCE INV-DAY.
    02 COLUMN 83     PIC X   VALUE "-".
    02 COLUMN 84     PIC 99  SOURCE INV-MO.
    02 COLUMN 86     PIC X   VALUE "-".
    02 COLUMN 87     PIC 9999 SOURCE INV-YR.
    02 COLUMN 92     PIC 9(6) SOURCE INVOICE-NUMBER.
    02 COLUMN 99     PIC $$$,$$$,$$$$.99-
                        SOURCE INVOICE-SALES.
    02 DETAIL-COUNT PIC S9(10) SOURCE ONE-COUNT.
    02 INV-AMOUNT  PIC S9(9)V99 SOURCE INVOICE-SALES.
01  TYPE IS CONTROL FOOTING NAME
    NEXT GROUP IS PLUS 2.
    02  LINE IS PLUS 2.
        03  COLUMN 72
            PIC X(41) VALUE ALL "*".
    02  LINE IS PLUS 1.
        03  COLUMN 20 PIC X(17) VALUE " TOTAL RECORDS: ".
        03 IDC COLUMN 40 PIC ZZZ,ZZZ,ZZ9 SUM ONE-COUNT.
        03 IIA COLUMN 99 PIC $$$,$$$,$$$$.99- SUM INVOICE-SALES.
    02  LINE IS PLUS 1.
        03  COLUMN 72
            PIC X(41) VALUE ALL "*".
01  FINAL-FOOTING TYPE IS CONTROL FOOTING FINAL
    NEXT GROUP NEXT PAGE.
    02  LINE IS PLUS 2.
        03  COLUMN 72
            PIC X(41) VALUE ALL "*".
    02  LINE IS PLUS 1.
        03  COLUMN 14 PIC X(21) VALUE "GRAND TOTAL RECORDS: ".
        03 FDC COLUMN 40 PIC ZZZ,ZZZ,ZZ9 SUM IDC.
        03  COLUMN 72 PIC X(22) VALUE " GRAND TOTAL INVOICES:".
        03 FIA COLUMN 95 PIC $,$$$,$$$,$$$$.99- SUM IIA.
    02  LINE IS PLUS 1.
        03  COLUMN 72
            PIC X(41) VALUE ALL "*".
01  REPORT-FOOTER TYPE IS REPORT FOOTING.
    02  LINE 24 ON NEXT PAGE COLUMN 45
        PIC X(31) VALUE ALL "*".
    02  LINE 25.
        03  COLUMN 45
            PIC X VALUE "*".
        03  COLUMN 75
            PIC X VALUE "*".
    02  LINE 26.
        03  COLUMN 45
            PIC X(31) VALUE "** Customer Master File **".

```

(continued on next page)

Example 10-7 (Cont.) Sample Program EX1007

```
02     LINE 27.
      03     COLUMN 45
          PIC X VALUE "*".
      03     COLUMN 75
          PIC X VALUE "*".
02     LINE 28.
      03     COLUMN 45
          PIC X VALUE "*".
      03     COLUMN 55
          PIC Z9
          SOURCE UE-DAY.
      03     COLUMN 57
          PIC X VALUE "-".
      03     COLUMN 58
          PIC 99
          SOURCE UE-MONTH.
      03     COLUMN 60
          PIC X VALUE "-".
      03     COLUMN 61
          PIC 9999
          SOURCE UE-YEAR.
      03     COLUMN 75
          PIC X VALUE "*".
02     LINE 29.
      03     COLUMN 45
          PIC X VALUE "*".
      03     COLUMN 75
          PIC X VALUE "*".
02     LINE 30.
      03     COLUMN 45
          PIC X(31) VALUE "*"      End of EX1007.LIS      "*".
02     LINE 31.
      03     COLUMN 45
          PIC X VALUE "*".
      03     COLUMN 75
          PIC X VALUE "*".
02     LINE 32 COLUMN 45
          PIC X(31) VALUE ALL "*".

PROCEDURE DIVISION.
DECLARATIVES.
BOR SECTION.
    USE BEFORE REPORTING REPORT-HEADER.
EOR SECTION.
    USE BEFORE REPORTING REPORT-FOOTER.
EOR-A.
    DISPLAY "*** Created EX1007.LIS ***".
END DECLARATIVES.
MAIN SECTION.
000-DO-SORT.
    SORT SORT-FILE ON ASCENDING KEY SORT-NAME
      WITH DUPLICATES IN ORDER
      USING CUSTOMER-FILE
      GIVING SORTED-FILE.
```

(continued on next page)

## Producing Printed Reports

### 10.9 Report Writer Examples

#### Example 10-7 (Cont.) Sample Program EX1007

```
000-START.  
    DISPLAY "*** EX1007 ***".  
    DISPLAY "Enter Current Date (YYYYMMDD) :".  
    ACCEPT UNEDITED-DATE.  
    OPEN INPUT  SORTED-FILE.  
    OPEN OUTPUT PRINTER-FILE.  
    INITIATE MASTER-LIST.  
    PERFORM 200-READ-MASTER UNTIL NAME = HIGH-VALUES.  
100-END-OF-FILE.  
    TERMINATE MASTER-LIST.  
    CLOSE SORTED-FILE, PRINTER-FILE.  
    STOP RUN.  
200-READ-MASTER.  
    READ SORTED-FILE AT END MOVE HIGH-VALUES TO NAME.  
    IF NAME NOT = HIGH-VALUES GENERATE DETAIL-LINE.
```

# Producing Printed Reports 10.9 Report Writer Examples

Figure 10-16 EX1007.LIS Listing

```

*****
*
* Customer Master File *
*
* 11-08-2000 *
*
* Report EX1007 *
* Detail Report *
*
*
*****

```

CUSTOMER MASTER FILE REPORT PAGE 2

NAME			ADDRESS			INVOICE			
LAST	FIRST	MI	STREET	CITY	ST	ZIP	DATE	NUMBER	AMOUNT
Abbott	John	B	12 Pleasant Street	Nashua	NH	03102	7-01-2000	000001	\$10,000.90
Abbott	John	B	12 Pleasant Street	Nashua	NH	03102	7-01-2000	000001	\$10,000.90
Abbott	John	B	12 Pleasant Street	Nashua	NH	03102	7-01-2000	000001	\$10,000.90
Abbott	John	B	12 Pleasant Street	Nashua	NH	03102	7-01-2000	000001	\$10,000.90
Abbott	John	B	12 Pleasant Street	Nashua	NH	03102	7-01-2000	000001	\$10,000.90
Abbott	John	B	12 Pleasant Street	Nashua	NH	03102	7-01-2000	000001	\$10,000.90
Abbott	John	B	12 Pleasant Street	Nashua	NH	03102	7-01-2000	000001	\$10,000.90
TOTAL RECORDS:									7
									\$70,006.30
Adam	Harold	B	980 Main Street	Nashua	NH	03102	2-06-2000	000002	\$21,008.90
TOTAL RECORDS:									1
									\$21,008.90
Albert	Robert	S	100 Meadow Lane	Gardner	MA	01420	2-06-2000	000003	\$61,009.00
TOTAL RECORDS:									1
									\$61,009.00
Alexander	Greg	T	317 Narrows Road	Westminster	MA	01473	2-06-2000	000004	\$10,000.71
Alexander	Greg	T	317 Narrows Road	Westminster	MA	01473	2-06-2000	000004	\$10,000.71
Alexander	Greg	T	317 Narrows Road	Westminster	MA	01473	2-06-2000	000004	\$10,000.71
Alexander	Greg	T	317 Narrows Road	East Westminster	MA	01473	2-06-2000	000004	\$10,000.71

CUSTOMER MASTER FILE REPORT PAGE 3

NAME			ADDRESS			INVOICE			
LAST	FIRST	MI	STREET	CITY	ST	ZIP	DATE	NUMBER	AMOUNT
Alexander	Greg	T	317 Narrows Road	Westminster	MA	01473	2-06-2000	000004	\$10,000.71
Alexander	Greg	T	317 Narrows Road	East Westminster	MA	01473	2-06-2000	000004	\$10,000.71
TOTAL RECORDS:									6
									\$60,004.26
Allan	David	L	10 Wonder Lane	Merrimack	NH	03014	2-06-2000	000001	\$24,101.00
TOTAL RECORDS:									1
									\$24,101.00
Alwin	Tom	F	400 High Street	Princeton	NJ	12341	3-07-2000	000008	\$70,000.17
TOTAL RECORDS:									1
									\$70,000.17
Ames	Alice	J	40 Center Road	Nashua	NH	03060	2-07-2000	000007	\$10,000.00
Ames	Alice	J	40 Center Road	Nashua	NH	03060	2-07-2000	000007	\$10,000.00
Ames	Alice	J	40 Center Road	Nashua	NH	03060	2-07-2000	000007	\$10,000.00
TOTAL RECORDS:									3
									\$30,000.00
Amico	Art	A	31 Athens Road	Nashua	NH	03060	2-06-2000	000007	\$12,340.70
TOTAL RECORDS:									1
									\$12,340.70

VM-0661A-AI

(continued on next page)

# Producing Printed Reports 10.9 Report Writer Examples

Figure 10–16 (Cont.) EX1007.LIS Listing

CUSTOMER MASTER FILE REPORT										PAGE 4
NAME			ADDRESS				INVOICE			
LAST	FIRST	MI	STREET	CITY	ST	ZIP	DATE	NUMBER	AMOUNT	
Amos	James	A	71 State Rd	East Westminster	MA	01473	2-06-2000	000006	\$41,000.90	
TOTAL RECORDS:			1				\$41,000.90			
Berger	Tom	H	700 McDonald Lane	Merrimack	NH	03060	2-06-2000	000010	\$12,341.60	
TOTAL RECORDS:			1				\$12,341.60			
Carroll	Alice	L	192 Lewis Road	London	NH	03416	2-07-2000	000012	\$16,789.00	
TOTAL RECORDS:			1				\$16,789.00			
Carter	Winston	R	123 Timpany Street	Brookline	NH	03078	2-07-2000	000011	\$23,416.76	
TOTAL RECORDS:			1				\$23,416.76			
Cooper	Frank	J	300 Mohican Avenue	Mohawk	MA	01480	2-07-2000	000014	\$34,167.80	
TOTAL RECORDS:			1				\$34,167.80			
Dickens	Arnold	C	100 Bleak Street	Gardner	MA	01440	2-07-2000	000011	\$12,341.67	
CUSTOMER MASTER FILE REPORT										PAGE 5
NAME			ADDRESS				INVOICE			
LAST	FIRST	MI	STREET	CITY	ST	ZIP	DATE	NUMBER	AMOUNT	
TOTAL RECORDS:			1				\$12,341.67			
Dickinson	Rose	E	21 Depot Road	Amherst	MA	01423	2-07-2000	000019	\$66,688.90	
TOTAL RECORDS:			1				\$66,688.90			
Frost	Alfred	R	123 Amherst Street	Merrimack	NH	03060	2-07-2000	000020	\$11,114.90	
TOTAL RECORDS:			1				\$11,114.90			
Hemingway	Joe	E	10 Cuba Street	Westminster	MA	01473	2-07-2000	000013	\$87,690.00	
TOTAL RECORDS:			1				\$87,690.00			
Thoreaux	Ralph	H	800 Emerson Street	Walden	MA	01416	2-07-2000	000016	\$6.00	
TOTAL RECORDS:			1				\$6.00			
Williams	Samuel	A	310 England Road	Worcester	MA	01400	2-07-2000	000017	\$78,900.00	
TOTAL RECORDS:			1				\$78,900.00			
CUSTOMER MASTER FILE REPORT										PAGE 6
GRAND TOTAL RECORDS:			32				GRAND TOTAL INVOICES: \$732,927.86			
*****										
* Customer Master File *										
* 11-08-2000 *										
* End of EX1007.LIS *										
*****										

VM-0661B-AI

## 10.9.4 EX1008—Detail Report Program

Example 10–8 (EX1008) is a Report Writer program that uses the REPORT HEADING, PAGE HEADING, DETAIL, CONTROL FOOTING, and REPORT FOOTING report groups and produces a detail report—EX1008.LIS (shown in Figure 10–17).

**Example 10-8 Sample Program EX1008**

```

IDENTIFICATION DIVISION.
PROGRAM-ID. EX1008.
ENVIRONMENT DIVISION.
CONFIGURATION SECTION.
INPUT-OUTPUT SECTION.
FILE-CONTROL.
    SELECT CUSTOMER-FILE ASSIGN TO "MASTER.DAT".
    SELECT SORT-FILE      ASSIGN TO "EX1008-SORTIN.TMP".
    SELECT SORTED-FILE   ASSIGN TO "EX1008-SORTOUT.TMP".
    SELECT PRINTER-FILE  ASSIGN TO "EX1008.LIS".

DATA DIVISION.
FILE SECTION.
SD      SORT-FILE.
01      SORTED-CUSTOMER-MASTER-FILE.
        02 SORT-NAME          PIC X(26).
        02                      PIC X(73).

FD      CUSTOMER-FILE.
01      CUSTOMER-MASTER-FILE PIC X(99).

FD      SORTED-FILE.
01      SORTED-RECORD.
        02 SORTED-NAME        PIC X(26).
        02 S-ADDRESS          PIC X(20).
        02 S-CITY             PIC X(20).
        02 S-STATE            PIC XX.
        02 S-ZIP              PIC 99999.
        02 S-SALESMAN-NUMBER  PIC 99999.
        02 S-INVOICE-DATA.
            03 S-INVOICE-NUMBER PIC 999999.
            03 S-INVOICE-SALES  PIC S9(5)V99.
            03 S-INVOICE-DATE.
                04 S-INV-DAY    PIC 99.
                04 S-INV-MO     PIC 99.
                04 S-INV-YR     PIC 9999.

FD      PRINTER-FILE
        REPORT IS MASTER-LIST.
WORKING-STORAGE SECTION.
01      UNEDITED-DATE.
        02 UE-YEAR            PIC 9999.
        02 UE-MONTH          PIC 99.
        02 UE-DAY            PIC 99.
        02 FILLER            PIC X(6).
01      ONE-COUNT            PIC 9 VALUE 1.
01      EOF                  PIC X VALUE "N".
01      SAVE-INVOICE-SALES  PIC S9(9)V99 VALUE 0.
01      CUSTOMER-MASTER-RECORD.
        02 NAME.
            03 LAST-NAME      PIC X(15).
            03 FIRST-NAME     PIC X(10).
            03 MIDDLE-INIT    PIC X.
        02 ADDRESS           PIC X(20).
        02 CITY              PIC X(20).
        02 STATE             PIC XX.
        02 ZIP               PIC 99999.
        02 SALESMAN-NUMBER  PIC 99999.
    
```

(continued on next page)

# Producing Printed Reports

## 10.9 Report Writer Examples

### Example 10-8 (Cont.) Sample Program EX1008

```
02 INVOICE-DATA.
    03 INVOICE-NUMBER      PIC 999999.
    03 INVOICE-SALES      PIC S9(5)V99.
    03 INVOICE-DATE.
        04 INV-DAY        PIC 99.
        04 INV-MO         PIC 99.
        04 INV-YR         PIC 9999.

REPORT SECTION.

RD  MASTER-LIST
    PAGE LIMIT IS 66
    HEADING      1
    FIRST DETAIL 13
    LAST DETAIL  55
    CONTROLS ARE FINAL.
01  REPORT-HEADER TYPE IS REPORT HEADING NEXT GROUP NEXT PAGE.
    02  LINE 24.
        03  COLUMN 45
            PIC X(31) VALUE ALL "*".
    02  LINE 25.
        03  COLUMN 45
            PIC X VALUE "*".
        03  COLUMN 75
            PIC X VALUE "*".
    02  LINE 26.
        03  COLUMN 45
            PIC X(31) VALUE "*" Customer Master File "*".
    02  LINE 27.
        03  COLUMN 45
            PIC X VALUE "*".
        03  COLUMN 75
            PIC X VALUE "*".
    02  LINE 28.
        03  COLUMN 45
            PIC X VALUE "*".
        03  COLUMN 55
            PIC Z9
            SOURCE UE-DAY.
        03  COLUMN 57
            PIC X VALUE "-".
        03  COLUMN 58
            PIC 99
            SOURCE UE-MONTH.
        03  COLUMN 60
            PIC X VALUE "-".
        03  COLUMN 61
            PIC 9999
            SOURCE UE-YEAR.
        03  COLUMN 75
            PIC X VALUE "*".
```

(continued on next page)



## Producing Printed Reports 10.9 Report Writer Examples

### Example 10-8 (Cont.) Sample Program EX1008

```
02     LINE 29.  
03     COLUMN 45  
        PIC X VALUE "*".  
03     COLUMN 75  
        PIC X VALUE "*".  
02     LINE 30.  
03     COLUMN 45  
        PIC X(31) VALUE "*"      Report EX1008      *".  
02     LINE 31.  
03     COLUMN 45  
        PIC X(31) VALUE "*"      Detail Report      *".  
02     LINE 32.  
03     COLUMN 45  
        PIC X VALUE "*".  
03     COLUMN 75  
        PIC X VALUE "*".  
02     LINE 33.  
03     COLUMN 45  
        PIC X VALUE "*".  
03     COLUMN 75  
        PIC X VALUE "*".  
02     LINE 34.  
03     COLUMN 45  
        PIC X(31) VALUE ALL "*".  
01     TYPE IS PAGE HEADING.  
02     LINE 5.  
03     COLUMN 1  
        PIC X(27) VALUE "CUSTOMER MASTER FILE REPORT".  
03     COLUMN 105  
        PIC X(4) VALUE "PAGE".  
03     COLUMN 109  
        PIC ZZZ9  
        SOURCE PAGE-COUNTER.  
02     LINE 7.  
03     COLUMN 1  
        PIC X VALUE "+".  
03     COLUMN 2  
        PIC X(110) VALUE ALL "-".  
03     COLUMN 112  
        PIC X VALUE "+".  
02     LINE 8.  
03     COLUMN 1  
        PIC X VALUE "|".  
03     COLUMN 10  
        PIC X(4) VALUE "NAME".  
03     COLUMN 29  
        PIC X VALUE "|".  
03     COLUMN 43  
        PIC X(7) VALUE "ADDRESS".  
03     COLUMN 81  
        PIC X VALUE "|".  
03     COLUMN 91  
        PIC X(7) VALUE "INVOICE".  
03     COLUMN 112  
        PIC X VALUE "|".
```

(continued on next page)

## Producing Printed Reports

### 10.9 Report Writer Examples

#### Example 10–8 (Cont.) Sample Program EX1008

```
02      LINE 9.
03      COLUMN 1
03      PIC X VALUE "|".
03      COLUMN 2
03      PIC X(110) VALUE ALL "-".
03      COLUMN 112
03      PIC X VALUE "|".
02      LINE 10.
03      COLUMN 1
03      PIC X(6) VALUE "| LAST".
03      COLUMN 16
03      PIC X(7) VALUE "| FIRST".
03      COLUMN 26
03      PIC X(4) VALUE "|MI|".
03      COLUMN 35
03      PIC X(6) VALUE "STREET".
03      COLUMN 48
03      PIC X VALUE "|".
03      COLUMN 52
03      PIC X(4) VALUE "CITY".
03      COLUMN 71
03      PIC X VALUE "|".
03      COLUMN 72
03      PIC X(2) VALUE "ST".
03      COLUMN 74
03      PIC X VALUE "|".
03      COLUMN 76
03      PIC X(3) VALUE "ZIP".
03      COLUMN 81
03      PIC X VALUE "|".
03      COLUMN 83
03      PIC X(4) VALUE "DATE".
03      COLUMN 90
03      PIC X VALUE "|".
03      COLUMN 92
03      PIC X(6) VALUE "NUMBER".
03      COLUMN 98
03      PIC X VALUE "|".
03      COLUMN 103
03      PIC X(6) VALUE "AMOUNT".
03      COLUMN 112
03      PIC X VALUE "|".
```

(continued on next page)

## Producing Printed Reports 10.9 Report Writer Examples

### Example 10-8 (Cont.) Sample Program EX1008

```
02     LINE 11.
      03     COLUMN 1
          PIC X VALUE "+".
      03     COLUMN 2
          PIC X(110) VALUE ALL "-".
      03     COLUMN 112
          PIC X VALUE "+".
01     DETAIL-LINE
      TYPE DETAIL LINE IS PLUS 1.
      02 COLUMN 1     PIC X(15) SOURCE LAST-NAME.
      02 COLUMN 17    PIC X(10) SOURCE FIRST-NAME.
      02 COLUMN 28    PIC XX  SOURCE MIDDLE-INIT.
      02 COLUMN 30    PIC X(20) SOURCE ADDRESS.
      02 COLUMN 51    PIC X(20) SOURCE CITY.
      02 COLUMN 72    PIC XX  SOURCE STATE.
      02 COLUMN 75    PIC 99999 SOURCE ZIP.
      02 COLUMN 81    PIC Z9  SOURCE INV-DAY.
      02 COLUMN 83    PIC X   VALUE "-".
      02 COLUMN 84    PIC 99  SOURCE INV-MO.
      02 COLUMN 86    PIC X   VALUE "-".
      02 COLUMN 87    PIC 9999 SOURCE INV-YR.
      02 COLUMN 92    PIC 9(6) SOURCE INVOICE-NUMBER.
      02 COLUMN 99    PIC $$$,$$$,$$$.$99-
                      SOURCE SAVE-INVOICE-SALES.
01     FINAL-FOOTING TYPE IS CONTROL FOOTING FINAL
      NEXT GROUP NEXT PAGE.
      02     LINE IS PLUS 2.
      03     COLUMN 70
          PIC X(43) VALUE ALL "*".
      02     LINE IS PLUS 1.
      03     COLUMN 70 PIC X(24) VALUE "*" GRAND TOTAL INVOICES:".
      03 FIA  COLUMN 94 PIC $,$$$,$$$,$$$.$99- SUM INVOICE-SALES.
      03     COLUMN 111 PIC XXX VALUE " * ".
      02     LINE IS PLUS 1.
      03     COLUMN 70
          PIC X(43) VALUE ALL "*".
01     REPORT-FOOTER TYPE IS REPORT FOOTING.
      02     LINE 24 ON NEXT PAGE COLUMN 45
          PIC X(31) VALUE ALL "*".
      02     LINE 25.
      03     COLUMN 45
          PIC X VALUE "*".
      03     COLUMN 75
          PIC X VALUE "*".
      02     LINE 26.
      03     COLUMN 45
          PIC X(31) VALUE "*" Customer Master File  "*".
      02     LINE 27.
      03     COLUMN 45
          PIC X VALUE "*".
      03     COLUMN 75
          PIC X VALUE "*".
```

(continued on next page)

## Producing Printed Reports 10.9 Report Writer Examples

### Example 10-8 (Cont.) Sample Program EX1008

```
02      LINE 28 .
03      COLUMN 45
          PIC X VALUE "*".
03      COLUMN 55
          PIC Z9
          SOURCE UE-DAY.
03      COLUMN 57
          PIC X VALUE "-".
03      COLUMN 58
          PIC 99
          SOURCE UE-MONTH.
03      COLUMN 60
          PIC X VALUE "-".
03      COLUMN 61
          PIC 9999
          SOURCE UE-YEAR.
03      COLUMN 75
          PIC X VALUE "*".
02      LINE 29.
03      COLUMN 45
          PIC X VALUE "*".
03      COLUMN 75
          PIC X VALUE "*".
02      LINE 30 COLUMN 45
          PIC X(31) VALUE "*"      End of Report EX1008      "*".
02      LINE 31.
03      COLUMN 45
          PIC X VALUE "*".
03      COLUMN 75
          PIC X VALUE "*".
02      LINE 32 COLUMN 45
          PIC X(31) VALUE ALL "*".

PROCEDURE DIVISION.

DECLARATIVES.
BOR SECTION.
    USE BEFORE REPORTING REPORT-HEADER.
EOR SECTION.
    USE BEFORE REPORTING REPORT-FOOTER.
EOR-A.
    DISPLAY "**** Created EX1008.LIS ****".
DET SECTION.
    USE BEFORE REPORTING DETAIL-LINE.
DET-A.
    IF SORTED-NAME = NAME
        MOVE SORTED-RECORD TO CUSTOMER-MASTER-RECORD
        ADD INVOICE-SALES TO SAVE-INVOICE-SALES
        SUPPRESS PRINTING.
    IF NAME = SPACES SUPPRESS PRINTING.
END DECLARATIVES.
```

(continued on next page)

**Example 10-8 (Cont.) Sample Program EX1008**

```
MAIN SECTION.  
000-DO-SORT.  
    SORT SORT-FILE ON ASCENDING KEY SORT-NAME  
    WITH DUPLICATES IN ORDER  
    USING CUSTOMER-FILE  
    GIVING SORTED-FILE.  
  
000-START.  
    DISPLAY "*** EX1008 ***".  
    DISPLAY "Enter Current Date (YYYYMMDD) :".  
    ACCEPT UNEDITED-DATE.  
    OPEN INPUT  SORTED-FILE.  
    OPEN OUTPUT PRINTER-FILE.  
    MOVE SPACES TO NAME.  
    INITIATE MASTER-LIST.  
    PERFORM 200-READ-MASTER UNTIL EOF = "Y".  
100-END-OF-FILE.  
    TERMINATE MASTER-LIST.  
    CLOSE SORTED-FILE, PRINTER-FILE.  
    STOP RUN.  
200-READ-MASTER.  
    READ SORTED-FILE AT END MOVE "Y" TO EOF  
    MOVE HIGH-VALUES TO SORTED-NAME.  
    GENERATE DETAIL-LINE.  
    IF SORTED-NAME NOT = NAME  
        MOVE S-INVOICE-SALES TO SAVE-INVOICE-SALES.  
    IF EOF NOT = "Y"  
        MOVE SORTED-RECORD TO CUSTOMER-MASTER-RECORD.
```

# Producing Printed Reports

## 10.9 Report Writer Examples

Figure 10–17 EX1008.LIS Listing

```

*****
*
*      Customer Master File
*
*      11-08-2000
*
*      Report EX1008
*      Detail Report
*
*****

CUSTOMER MASTER FILE REPORT                                     PAGE 2
+-----+-----+-----+-----+-----+-----+-----+-----+-----+
| NAME | ADDRESS | INVOICE |
+-----+-----+-----+-----+-----+-----+-----+-----+-----+
| LAST | FIRST | MI | STREET | CITY | ST | ZIP | DATE | NUMBER | AMOUNT |
+-----+-----+-----+-----+-----+-----+-----+-----+-----+
Abbott  John  B 12 Pleasant Street  Nashua  NH 03102 7-01-2000 000001 $70,006.30
Adam    Harold B 980 Main Street      Nashua  NH 03102 2-06-2000 000002 $21,008.90
Albert  Robert S 100 Meadow Lane      Gardner MA 01420 2-06-2000 000003 $61,009.00
Alexander Greg  T 317 Narrows Road     East Westminster MA 01473 2-06-2000 000004 $60,004.26
Allan   David  L 10 Wonder Lane       Merrimack NH 03014 2-06-2000 000001 $24,101.00
Alwin   Tom    F 400 High Street      Princeton NJ 12341 3-07-2000 000008 $70,000.17
Ames    Alice  J 40 Center Road       Nashua    NH 03060 2-07-2000 000007 $30,000.00
Amico   Art    A 31 Athens Road       Nashua    NH 03060 2-06-2000 000007 $12,340.70
Amos    James A 71 State Rd          East Westminster MA 01473 2-06-2000 000006 $41,000.90
Berger  Tom    H 700 McDonald Lane    Merrimack NH 03060 2-06-2000 000010 $12,341.60
Carroll Alice  L 192 Lewis Road       London    NH 03416 2-07-2000 000012 $16,789.00
Carter  Winston R 123 Timpany Street    Brookline NH 03078 2-07-2000 000011 $23,416.76
Cooper  Frank  J 300 Mohican Avenue    Mohawk    MA 01480 2-07-2000 000014 $34,167.80
Dickens Arnold C 100 Bleak Street      Gardner    MA 01440 2-07-2000 000011 $12,341.67
Dickinson Rose  E 21 Depot Road        Amherst   MA 01423 2-07-2000 000019 $66,688.90
Frost   Alfred R 123 Amherst Street    Merrimack NH 03060 2-07-2000 000020 $11,114.90
Hemingway Joe    E 10 Cuba Street       Westminster MA 01473 2-07-2000 000013 $87,690.00
Thoreaux Ralph H 800 Emerson Street    Walden    MA 01416 2-07-2000 000016 $6.00
Williams Samuel A 310 England Road      Worcester MA 01400 2-07-2000 000017 $78,900.00
*****
* GRAND TOTAL INVOICES: $732,927.86 *
*****

*****
*
*      Customer Master File
*
*      11-08-2000
*
*      End of Report EX1008
*
*****

```

VM-0662A-AI

### 10.9.5 EX1009—Detail Report Program

Example 10–9 (EX1009) is a Report Writer program that uses the REPORT HEADING, PAGE HEADING, DETAIL, PAGE FOOTING, CONTROL FOOTING, and REPORT FOOTING report groups. The program also uses the TYPE DETAIL clause—GROUP INDICATE. The program produces a detail report—EX1009.LIS (shown in Figure 10–18).

#### Example 10–9 Sample Program EX1009

```

IDENTIFICATION DIVISION.
PROGRAM-ID. EX1009.
ENVIRONMENT DIVISION.
CONFIGURATION SECTION.
INPUT-OUTPUT SECTION.
FILE-CONTROL.
    SELECT CUSTOMER-FILE ASSIGN TO "MASTER.DAT".
    SELECT SORT-FILE     ASSIGN TO "EX1009-SORTIN.TMP".
    SELECT SORTED-FILE   ASSIGN TO "EX1009-SORTOUT.TMP".
    SELECT PRINTER-FILE  ASSIGN TO "EX1009.LIS".

```

(continued on next page)

## Producing Printed Reports 10.9 Report Writer Examples

### Example 10-9 (Cont.) Sample Program EX1009

```
DATA DIVISION.
FILE SECTION.
SD      SORT-FILE.
01      SORTED-CUSTOMER-MASTER-FILE.
         02 SORT-NAME          PIC X(26).
         02                      PIC X(73).
FD      CUSTOMER-FILE.
01      CUSTOMER-MASTER-FILE    PIC X(99).
FD      SORTED-FILE.
01      CUSTOMER-MASTER-FILE.
         02 NAME.
             03 LAST-NAME        PIC X(15).
             03 FIRST-NAME       PIC X(10).
             03 MIDDLE-INIT      PIC X.
         02 ADDRESS             PIC X(20).
         02 CITY                PIC X(20).
         02 STATE               PIC XX.
         02 ZIP                 PIC 99999.
         02 SALESMAN-NUMBER     PIC 99999.
         02 INVOICE-DATA.
             03 INVOICE-NUMBER   PIC 999999.
             03 INVOICE-SALES   PIC S9(5)V99.
             03 INVOICE-DATE.
                 04 INV-DAY     PIC 99.
                 04 INV-MO      PIC 99.
                 04 INV-YR     PIC 9999.

FD      PRINTER-FILE
         REPORT IS MASTER-LIST.
WORKING-STORAGE SECTION.
01      UNEDITED-DATE.
         02 UE-YEAR            PIC 9999.
         02 UE-MONTH          PIC 99.
         02 UE-DAY            PIC 99.
         02 FILLER            PIC X(6).

01      ONE-COUNT PIC 9 VALUE 1.
REPORT SECTION.
RD MASTER-LIST
         PAGE LIMIT IS 66
         HEADING          1
         FIRST DETAIL     13
         LAST DETAIL      55
         FOOTING          58
         CONTROLS ARE FINAL
                           NAME.
```

(continued on next page)

# Producing Printed Reports

## 10.9 Report Writer Examples

### Example 10-9 (Cont.) Sample Program EX1009

```
01 REPORT-HEADER TYPE IS REPORT HEADING NEXT GROUP NEXT PAGE.
02 LINE 24.
03 COLUMN 45
   PIC X(31) VALUE ALL "*".
02 LINE 25.
03 COLUMN 45
   PIC X VALUE "*".
03 COLUMN 75
   PIC X VALUE "*".
02 LINE 26.
03 COLUMN 45
   PIC X(31) VALUE "*" Customer Master File "*".
02 LINE 27.
03 COLUMN 45
   PIC X VALUE "*".
03 COLUMN 75
   PIC X VALUE "*".
02 LINE 28.
03 COLUMN 45
   PIC X VALUE "*".
03 COLUMN 55
   PIC Z9
   SOURCE UE-DAY.
03 COLUMN 57
   PIC X VALUE "-".
03 COLUMN 58
   PIC 99
   SOURCE UE-MONTH.
03 COLUMN 60
   PIC X VALUE "-".
03 COLUMN 61
   PIC 9999
   SOURCE UE-YEAR.
03 COLUMN 75
   PIC X VALUE "*".
02 LINE 29.
03 COLUMN 45
   PIC X VALUE "*".
03 COLUMN 75
   PIC X VALUE "*".
02 LINE 30.
03 COLUMN 45
   PIC X(31) VALUE "*" GROUP INDICATE "*".
02 LINE 31.
03 COLUMN 45
   PIC X(31) VALUE "*" Detail Report EX1009 "*".
02 LINE 32.
03 COLUMN 45
   PIC X VALUE "*".
03 COLUMN 75
   PIC X VALUE "*".
```

(continued on next page)



## Producing Printed Reports 10.9 Report Writer Examples

### Example 10–9 (Cont.) Sample Program EX1009

```
02     LINE 33.  
03     COLUMN 45  
        PIC X VALUE "*".  
03     COLUMN 75  
        PIC X VALUE "*".  
02     LINE 34.  
03     COLUMN 45  
        PIC X(31) VALUE ALL "*".  
01 TYPE IS PAGE HEADING.  
02     LINE 5.  
03     COLUMN 1  
        PIC X(27) VALUE "CUSTOMER MASTER FILE REPORT".  
03     COLUMN 105  
        PIC X(4) VALUE "PAGE".  
03     COLUMN 109  
        PIC ZZZ9  
        SOURCE PAGE-COUNTER.  
02     LINE 7.  
03     COLUMN 1  
        PIC X VALUE "+".  
03     COLUMN 2  
        PIC X(110) VALUE ALL "-".  
03     COLUMN 112  
        PIC X VALUE "+".  
02     LINE 8.  
03     COLUMN 1  
        PIC X VALUE "|".  
03     COLUMN 10  
        PIC X(4) VALUE "NAME".  
03     COLUMN 29  
        PIC X VALUE "|".  
03     COLUMN 43  
        PIC X(7) VALUE "ADDRESS".  
03     COLUMN 81  
        PIC X VALUE "|".  
03     COLUMN 91  
        PIC X(7) VALUE "INVOICE".  
03     COLUMN 112  
        PIC X VALUE "|".  
02     LINE 9.  
03     COLUMN 1  
        PIC X VALUE "|".  
03     COLUMN 2  
        PIC X(110) VALUE ALL "-".  
03     COLUMN 112  
        PIC X VALUE "|".  
02     LINE 10.  
03     COLUMN 1  
        PIC X(6) VALUE "| LAST".  
03     COLUMN 16  
        PIC X(7) VALUE "| FIRST".  
03     COLUMN 26  
        PIC X(4) VALUE "|MI|".
```

(continued on next page)

# Producing Printed Reports

## 10.9 Report Writer Examples

### Example 10-9 (Cont.) Sample Program EX1009

```

03      COLUMN 35
        PIC X(6) VALUE "STREET".
03      COLUMN 48
        PIC X VALUE "|".
03      COLUMN 52
        PIC X(4) VALUE "CITY".
03      COLUMN 71
        PIC X VALUE "|".
03      COLUMN 72
        PIC X(2) VALUE "ST".
03      COLUMN 74
        PIC X VALUE "|".
03      COLUMN 76
        PIC X(3) VALUE "ZIP".
03      COLUMN 81
        PIC X VALUE "|".
03      COLUMN 83
        PIC X(4) VALUE "DATE".
03      COLUMN 90
        PIC X VALUE "|".
03      COLUMN 92
        PIC X(6) VALUE "NUMBER".
03      COLUMN 98
        PIC X VALUE "|".
03      COLUMN 103
        PIC X(6) VALUE "AMOUNT".
03      COLUMN 112
        PIC X VALUE "|".
02      LINE 11.
03      COLUMN 1
        PIC X VALUE "+".
03      COLUMN 2
        PIC X(110) VALUE ALL "-".
03      COLUMN 112
        PIC X VALUE "+".
01      DETAIL-LINE
        TYPE DETAIL
        LINE PLUS 1.
02      COLUMN 1      PIC X(15) SOURCE LAST-NAME      GROUP INDICATE.
02      COLUMN 17     PIC X(10) SOURCE FIRST-NAME     GROUP INDICATE.
02      COLUMN 28     PIC XX SOURCE MIDDLE-INIT      GROUP INDICATE.
02      COLUMN 30     PIC X(20) SOURCE ADDRESS.
02      COLUMN 51     PIC X(20) SOURCE CITY.
02      COLUMN 72     PIC XX SOURCE STATE.
02      COLUMN 75     PIC 99999 SOURCE ZIP.
02      COLUMN 81     PIC Z9 SOURCE INV-DAY.
02      COLUMN 83     PIC X VALUE "-".
02      COLUMN 84     PIC 99 SOURCE INV-MO.
02      COLUMN 86     PIC X VALUE "-".
02      COLUMN 87     PIC 9999 SOURCE INV-YR.
02      COLUMN 92     PIC 9(6) SOURCE INVOICE-NUMBER.
02      COLUMN 99     PIC $$$,$$$,$$$$.99-
                     SOURCE INVOICE-SALES.
02      DETAIL-COUNT  PIC S9(10) SOURCE ONE-COUNT.
02      INV-AMOUNT   PIC S9(9)V99 SOURCE INVOICE-SALES.

```

(continued on next page)

## Producing Printed Reports 10.9 Report Writer Examples

### Example 10-9 (Cont.) Sample Program EX1009

```
01 PAGE-FOOTING TYPE IS PAGE FOOTING.
02 LINE 59.
03 COLUMN 45
   PIC X(16) VALUE "C O M P A N Y ".
03 COLUMN 62
   PIC X(25) VALUE "C O N F I D E N T I A L ".
02 LINE 60.
03 COLUMN 45
   PIC X(16) VALUE "C O M P A N Y ".
03 COLUMN 62
   PIC X(25) VALUE "C O N F I D E N T I A L ".

01 TYPE IS CONTROL FOOTING NAME
   NEXT GROUP IS PLUS 2.
02 LINE IS PLUS 2.
03 COLUMN 73
   PIC X(39) VALUE ALL "*".
02 LINE IS PLUS 1.
03 COLUMN 20 PIC X(17) VALUE " TOTAL RECORDS: ".
03 IDC COLUMN 40 PIC ZZZ,ZZZ,ZZ9 SUM ONE-COUNT.
03 COLUMN 73 PIC X(22) VALUE "* INVOICE SUB TOTAL: ".
03 IIA COLUMN 96 PIC $$$,$$$,$$$99- SUM INVOICE-SALES.
03 COLUMN 111 PIC X VALUE "*".
02 LINE IS PLUS 1.
03 COLUMN 73
   PIC X(39) VALUE ALL "*".

01 FINAL-FOOTING TYPE IS CONTROL FOOTING FINAL
   NEXT GROUP NEXT PAGE.
02 LINE IS PLUS 2.
03 COLUMN 70
   PIC X(42) VALUE ALL "*".
02 LINE IS PLUS 1.
03 COLUMN 14 PIC X(21) VALUE "GRAND TOTAL RECORDS: ".
03 FDC COLUMN 40 PIC ZZZ,ZZZ,ZZ9 SUM IDC.
03 COLUMN 70 PIC X(24) VALUE "* GRAND TOTAL INVOICES:".
03 FIA COLUMN 94 PIC $,$$$,$$$,$$$99- SUM IIA.
03 COLUMN 111 PIC X VALUE "*".
02 LINE IS PLUS 1.
03 COLUMN 70
   PIC X(42) VALUE ALL "*".

01 REPORT-FOOTER TYPE IS REPORT FOOTING.
02 LINE 24 ON NEXT PAGE COLUMN 45
   PIC X(31) VALUE ALL "*".
02 LINE 25.
03 COLUMN 45
   PIC X VALUE "*".
03 COLUMN 75
   PIC X VALUE "*".
02 LINE 26.
03 COLUMN 45
   PIC X(31) VALUE "* Customer Master File *".
02 LINE 27.
03 COLUMN 45
   PIC X VALUE "*".
03 COLUMN 75
   PIC X VALUE "*".
```

(continued on next page)

## Producing Printed Reports

### 10.9 Report Writer Examples

#### Example 10-9 (Cont.) Sample Program EX1009

```
02      LINE 28.
03          COLUMN 45
          PIC X VALUE "*".
03          COLUMN 55
          PIC Z9
          SOURCE UE-DAY.
03          COLUMN 57
          PIC X VALUE "-".
03          COLUMN 58
          PIC 99
          SOURCE UE-MONTH.
03          COLUMN 60
          PIC X VALUE "-".
03          COLUMN 61
          PIC 9999
          SOURCE UE-YEAR.
03          COLUMN 75
          PIC X VALUE "*".
02      LINE 29.
03          COLUMN 45
          PIC X VALUE "*".
03          COLUMN 75
          PIC X VALUE "*".
02      LINE 30 COLUMN 45
          PIC X(31) VALUE "*"      End of Report EX1009      *".
02      LINE 31.
03          COLUMN 45
          PIC X VALUE "*".
03          COLUMN 75
          PIC X VALUE "*".
02      LINE 32 COLUMN 45
          PIC X(31) VALUE ALL "*".

PROCEDURE DIVISION.
DECLARATIVES.
BOR SECTION.
    USE BEFORE REPORTING REPORT-HEADER.
EOR SECTION.
    USE BEFORE REPORTING REPORT-FOOTER.
EOR-A.
    DISPLAY "**** Created EX1009.LIS ****".
END DECLARATIVES.
MAIN SECTION.
000-DO-SORT.
    SORT SORT-FILE ON ASCENDING KEY SORT-NAME
      WITH DUPLICATES IN ORDER
      USING CUSTOMER-FILE
      GIVING SORTED-FILE.
000-START.
    DISPLAY "**** EX1009 ****".
    DISPLAY "Enter Current Date (YYYYMMDD) :".
    ACCEPT UNEDITED-DATE.
    OPEN INPUT SORTED-FILE.
    OPEN OUTPUT PRINTER-FILE.
    INITIATE MASTER-LIST.
    PERFORM 200-READ-MASTER UNTIL NAME = HIGH-VALUES.
```

(continued on next page)

**Example 10–9 (Cont.) Sample Program EX1009**

```
100-END-OF-FILE.  
    TERMINATE MASTER-LIST.  
    CLOSE SORTED-FILE, PRINTER-FILE.  
    STOP RUN.  
200-READ-MASTER.  
    READ SORTED-FILE AT END MOVE HIGH-VALUES TO NAME.  
    IF NAME NOT = HIGH-VALUES GENERATE DETAIL-LINE.
```

# Producing Printed Reports 10.9 Report Writer Examples

Figure 10-18 EX1009.LIS Listing

```

*****
*
* Customer Master File *
*
* 11-08-2000 *
*
* GROUP INDICATE *
* Detail Report EX1009 *
*
*****

```

CUSTOMER MASTER FILE REPORT PAGE 2

NAME		ADDRESS				INVOICE			
LAST	FIRST	MI	STREET	CITY	ST	ZIP	DATE	NUMBER	AMOUNT
Abbott	John	B	12 Pleasant Street	Nashua	NH	03102	7-01-2000	000001	\$10,000.90
			12 Pleasant Street	Nashua	NH	03102	7-01-2000	000001	\$10,000.90
			12 Pleasant Street	Nashua	NH	03102	7-01-2000	000001	\$10,000.90
			12 Pleasant Street	Nashua	NH	03102	7-01-2000	000001	\$10,000.90
			12 Pleasant Street	Nashua	NH	03102	7-01-2000	000001	\$10,000.90
			12 Pleasant Street	Nashua	NH	03102	7-01-2000	000001	\$10,000.90
			12 Pleasant Street	Nashua	NH	03102	7-01-2000	000001	\$10,000.90
			12 Pleasant Street	Nashua	NH	03102	7-01-2000	000001	\$10,000.90
TOTAL RECORDS:				7	* INVOICE SUB TOTAL: \$70,006.30 *				
Adam	Harold	B	980 Main Street	Nashua	NH	03102	2-06-2000	000002	\$21,008.90
TOTAL RECORDS:				1	* INVOICE SUB TOTAL: \$21,008.90 *				
Albert	Robert	S	100 Meadow Lane	Gardner	MA	01420	2-06-2000	000003	\$61,009.00
TOTAL RECORDS:				1	* INVOICE SUB TOTAL: \$61,009.00 *				
Alexander	Greg	T	317 Narrows Road	Westminster	MA	01473	2-06-2000	000004	\$10,000.71
			317 Narrows Road	Westminster	MA	01473	2-06-2000	000004	\$10,000.71
			317 Narrows Road	Westminster	MA	01473	2-06-2000	000004	\$10,000.71
			317 Narrows Road	East Westminster	MA	01473	2-06-2000	000004	\$10,000.71
			317 Narrows Road	Westminster	MA	01473	2-06-2000	000004	\$10,000.71
			317 Narrows Road	East Westminster	MA	01473	2-06-2000	000004	\$10,000.71
TOTAL RECORDS:				6	* INVOICE SUB TOTAL: \$60,004.26 *				
Allan	David	L	10 Wonder Lane	Merrimack	NH	03014	2-06-2000	000001	\$24,101.00
TOTAL RECORDS:				1	* INVOICE SUB TOTAL: \$24,101.00 *				

C O M P A N Y C O N F I D E N T I A L  
C O M P A N Y C O N F I D E N T I A L

CUSTOMER MASTER FILE REPORT PAGE 3

NAME		ADDRESS				INVOICE			
LAST	FIRST	MI	STREET	CITY	ST	ZIP	DATE	NUMBER	AMOUNT
Alwin	Tom	F	400 High Street	Princeton	NJ	12341	3-07-2000	000008	\$70,000.17
TOTAL RECORDS:				1	* INVOICE SUB TOTAL: \$70,000.17 *				
Ames	Alice	J	40 Center Road	Nashua	NH	03060	2-07-2000	000007	\$10,000.00
			40 Center Road	Nashua	NH	03060	2-07-2000	000007	\$10,000.00
			40 Center Road	Nashua	NH	03060	2-07-2000	000007	\$10,000.00
TOTAL RECORDS:				3	* INVOICE SUB TOTAL: \$30,000.00 *				
Amico	Art	A	31 Athens Road	Nashua	NH	03060	2-06-2000	000007	\$12,340.70
TOTAL RECORDS:				1	* INVOICE SUB TOTAL: \$12,340.70 *				
Amos	James	A	71 State Rd	East Westminster	MA	01473	2-06-2000	000006	\$41,000.90
TOTAL RECORDS:				1	* INVOICE SUB TOTAL: \$41,000.90 *				
Berger	Tom	H	700 McDonald Lane	Merrimack	NH	03060	2-06-2000	000010	\$12,341.60
TOTAL RECORDS:				1	* INVOICE SUB TOTAL: \$12,341.60 *				
Carroll	Alice	L	192 Lewis Road	London	NH	03416	2-07-2000	000012	\$16,789.00
TOTAL RECORDS:				1	* INVOICE SUB TOTAL: \$16,789.00 *				

C O M P A N Y C O N F I D E N T I A L  
C O M P A N Y C O N F I D E N T I A L

VM-0663A-AI

(continued on next page)

Figure 10–18 (Cont.) EX1009.LIS Listing

CUSTOMER MASTER FILE REPORT										PAGE 4
NAME			ADDRESS				INVOICE			
LAST	FIRST	MI	STREET	CITY	ST	ZIP	DATE	NUMBER	AMOUNT	
Carter	Winston	R	123 Timpany Street	Brookline	NH	03078	2-07-2000	000011	\$23,416.76	
TOTAL RECORDS:				1	* INVOICE SUB TOTAL: \$23,416.76 *					
Cooper	Frank	J	300 Mohican Avenue	Mohawk	MA	01480	2-07-2000	000014	\$34,167.80	
TOTAL RECORDS:				1	* INVOICE SUB TOTAL: \$34,167.80 *					
Dickens	Arnold	C	100 Bleak Street	Gardner	MA	01440	2-07-2000	000011	\$12,341.67	
TOTAL RECORDS:				1	* INVOICE SUB TOTAL: \$12,341.67 *					
Dickinson	Rose	E	21 Depot Road	Amherst	MA	01423	2-07-2000	000019	\$66,688.90	
TOTAL RECORDS:				1	* INVOICE SUB TOTAL: \$66,688.90 *					
Frost	Alfred	R	123 Amherst Street	Merrimack	NH	03060	2-07-2000	000020	\$11,114.90	
TOTAL RECORDS:				1	* INVOICE SUB TOTAL: \$11,114.90 *					
Hemingway	Joe	E	10 Cuba Street	Westminster	MA	01473	2-07-2000	000013	\$87,690.00	
TOTAL RECORDS:				1	* INVOICE SUB TOTAL: \$87,690.00 *					
Thoreaux	Ralph	H	800 Emerson Street	Walden	MA	01416	2-07-2000	000016	\$6.00	
COMPANY CONFIDENTIAL COMPANY CONFIDENTIAL COMPANY CONFIDENTIAL										
CUSTOMER MASTER FILE REPORT										PAGE 5
NAME			ADDRESS				INVOICE			
LAST	FIRST	MI	STREET	CITY	ST	ZIP	DATE	NUMBER	AMOUNT	
TOTAL RECORDS:				1	* INVOICE SUB TOTAL: \$6.00 *					
Williams	Samuel	A	310 England Road	Worcester	MA	01400	2-07-2000	000017	\$78,900.00	
TOTAL RECORDS:				1	* INVOICE SUB TOTAL: \$78,900.00 *					
GRAND TOTAL RECORDS:				32	* GRAND TOTAL INVOICES: \$732,927.86 *					
COMPANY CONFIDENTIAL COMPANY CONFIDENTIAL COMPANY CONFIDENTIAL * * Customer Master File * * * 11-08-2000 * * * End of Report EX1009 * * *****										

VM-0663B-AI

### 10.9.6 EX1010—Summary Report Program

Example 10–10 (EX1010) is a Report Writer program that uses the REPORT HEADING, PAGE HEADING, DETAIL, CONTROL FOOTING, PAGE FOOTING, and REPORT FOOTING report groups. The program produces a summary report—EX1010.LIS (shown in Figure 10–19)—because the GENERATE statement specifies a report name (MASTER-LIST) rather than a DETAIL report group.

# Producing Printed Reports

## 10.9 Report Writer Examples

### Example 10-10 Sample Program EX1010

```
IDENTIFICATION DIVISION.
PROGRAM-ID. EX1010.
ENVIRONMENT DIVISION.
CONFIGURATION SECTION.
INPUT-OUTPUT SECTION.
FILE-CONTROL.
    SELECT CUSTOMER-FILE ASSIGN TO "MASTER.DAT".
    SELECT SORT-FILE      ASSIGN TO "EX1010-SORTIN.TMP".
    SELECT SORTED-FILE    ASSIGN TO "EX1010-SORTOUT.TMP".
    SELECT PRINTER-FILE  ASSIGN TO "EX1010.LIS".

DATA DIVISION.
FILE SECTION.
SD    SORT-FILE.
01    SORTED-CUSTOMER-MASTER-FILE.
      02 SORT-NAME          PIC X(26).
      02                      PIC X(73).

FD    CUSTOMER-FILE.
01    CUSTOMER-MASTER-FILE PIC X(99).

FD    SORTED-FILE.
01    CUSTOMER-MASTER-FILE.
      02 NAME.
          03 LAST-NAME      PIC X(15).
          03 FIRST-NAME     PIC X(10).
          03 MIDDLE-INIT    PIC X.
      02 ADDRESS           PIC X(20).
      02 CITY              PIC X(20).
      02 STATE             PIC XX.
      02 ZIP               PIC 99999.
      02 SALESMAN-NUMBER   PIC 99999.
      02 INVOICE-DATA.
          03 INVOICE-NUMBER PIC 999999.
          03 INVOICE-SALES  PIC S9(5)V99.
          03 INVOICE-DATE.
              04 INV-DAY    PIC 99.
              04 INV-MO     PIC 99.
              04 INV-YR     PIC 9999.

FD    PRINTER-FILE
      REPORT IS MASTER-LIST.

WORKING-STORAGE SECTION.
01    UNEDITED-DATE.
      02 UE-YEAR          PIC 9999.
      02 UE-MONTH        PIC 99.
      02 UE-DAY          PIC 99.
      02 FILLER          PIC X(6).

01    ONE-COUNT          PIC 9 VALUE 1.
```

(continued on next page)



## Producing Printed Reports 10.9 Report Writer Examples

### Example 10-10 (Cont.) Sample Program EX1010

```
REPORT SECTION.  
RD   MASTER-LIST  
     PAGE LIMIT IS 66  
     HEADING      1  
     FIRST DETAIL 13  
     LAST DETAIL  55  
     FOOTING      58  
     CONTROLS ARE FINAL  
           NAME.  
01   REPORT-HEADER TYPE IS REPORT HEADING NEXT GROUP NEXT PAGE.  
     02   LINE 24.  
           03   COLUMN 45  
             PIC X(31) VALUE ALL "*".  
     02   LINE 25.  
           03   COLUMN 45  
             PIC X VALUE "*".  
           03   COLUMN 75  
             PIC X VALUE "*".  
     02   LINE 26.  
           03   COLUMN 45  
             PIC X(31) VALUE "*" Customer Master File      "*".  
     02   LINE 27.  
           03   COLUMN 45  
             PIC X VALUE "*".  
           03   COLUMN 75  
             PIC X VALUE "*".  
     02   LINE 28.  
           03   COLUMN 45  
             PIC X VALUE "*".  
           03   COLUMN 55  
             PIC Z9  
             SOURCE UE-DAY.  
           03   COLUMN 57  
             PIC X VALUE "-".  
           03   COLUMN 58  
             PIC 99  
             SOURCE UE-MONTH.  
           03   COLUMN 60  
             PIC X VALUE "-".  
           03   COLUMN 61  
             PIC 9999  
             SOURCE UE-YEAR.  
           03   COLUMN 75  
             PIC X VALUE "*".  
     02   LINE 29.  
           03   COLUMN 45  
             PIC X VALUE "*".  
           03   COLUMN 75  
             PIC X VALUE "*".  
     02   LINE 30.  
           03   COLUMN 45  
             PIC X(31) VALUE "*" Report EX1010              "*".  
     02   LINE 31.  
           03   COLUMN 45  
             PIC X(31) VALUE "*" Summary Report             "*".
```

(continued on next page)

## Producing Printed Reports

### 10.9 Report Writer Examples

#### Example 10-10 (Cont.) Sample Program EX1010

```
02     LINE 32.
      03     COLUMN 45
          PIC X VALUE "*".
      03     COLUMN 75
          PIC X VALUE "*".
02     LINE 33.
      03     COLUMN 45
          PIC X VALUE "*".
      03     COLUMN 75
          PIC X VALUE "*".
02     LINE 34.
      03     COLUMN 45
          PIC X(31) VALUE ALL "*".
01 TYPE IS PAGE HEADING.
02     LINE 5.
      03     COLUMN 1
          PIC X(27) VALUE "CUSTOMER MASTER FILE REPORT".
      03     COLUMN 105
          PIC X(4) VALUE "PAGE".
      03     COLUMN 109
          PIC ZZZ9
          SOURCE PAGE-COUNTER.
02     LINE 7.
      03     COLUMN 1
          PIC X VALUE "+".
      03     COLUMN 2
          PIC X(110) VALUE ALL "-".
      03     COLUMN 112
          PIC X VALUE "+".
02     LINE 8.
      03     COLUMN 1
          PIC X VALUE "|".
      03     COLUMN 10
          PIC X(4) VALUE "NAME".
      03     COLUMN 29
          PIC X VALUE "|".
      03     COLUMN 43
          PIC X(7) VALUE "ADDRESS".
      03     COLUMN 81
          PIC X VALUE "|".
      03     COLUMN 91
          PIC X(7) VALUE "INVOICE".
      03     COLUMN 112
          PIC X VALUE "|".
```

(continued on next page)

Example 10-10 (Cont.) Sample Program EX1010

```
02     LINE 9.
      03     COLUMN 1
          PIC X VALUE "|".
      03     COLUMN 2
          PIC X(110) VALUE ALL "-".
      03     COLUMN 112
          PIC X VALUE "|".
02     LINE 10.
      03     COLUMN 1
          PIC X(6) VALUE "| LAST".
      03     COLUMN 16
          PIC X(7) VALUE "| FIRST".
      03     COLUMN 26
          PIC X(4) VALUE "|MI|".
      03     COLUMN 35
          PIC X(6) VALUE "STREET".
      03     COLUMN 48
          PIC X VALUE "|".
      03     COLUMN 52
          PIC X(4) VALUE "CITY".
      03     COLUMN 71
          PIC X VALUE "|".
      03     COLUMN 72
          PIC X(2) VALUE "ST".
      03     COLUMN 74
          PIC X VALUE "|".
      03     COLUMN 76
          PIC X(3) VALUE "ZIP".
      03     COLUMN 81
          PIC X VALUE "|".
      03     COLUMN 83
          PIC X(4) VALUE "DATE".
      03     COLUMN 90
          PIC X VALUE "|".
      03     COLUMN 92
          PIC X(6) VALUE "NUMBER".
      03     COLUMN 98
          PIC X VALUE "|".
      03     COLUMN 103
          PIC X(6) VALUE "AMOUNT".
      03     COLUMN 112
          PIC X VALUE "|".
02     LINE 11.
      03     COLUMN 1
          PIC X VALUE "+".
      03     COLUMN 2
          PIC X(110) VALUE ALL "-".
      03     COLUMN 112
          PIC X VALUE "+".
```

(continued on next page)

# Producing Printed Reports

## 10.9 Report Writer Examples

### Example 10-10 (Cont.) Sample Program EX1010

```

01      DETAIL-LINE
        TYPE DETAIL
        LINE PLUS 1.
02 COLUMN 1      PIC X(15) SOURCE LAST-NAME      GROUP INDICATE.
02 COLUMN 17     PIC X(10) SOURCE FIRST-NAME     GROUP INDICATE.
02 COLUMN 28     PIC XX  SOURCE MIDDLE-INIT     GROUP INDICATE.
02 COLUMN 30     PIC X(20) SOURCE ADDRESS.
02 COLUMN 51     PIC X(20) SOURCE CITY.
02 COLUMN 72     PIC XX  SOURCE STATE.
02 COLUMN 75     PIC 99999 SOURCE ZIP.
02 COLUMN 81     PIC Z9  SOURCE INV-DAY.
02 COLUMN 83     PIC X   VALUE "-".
02 COLUMN 84     PIC 99  SOURCE INV-MO.
02 COLUMN 86     PIC X   VALUE "-".
02 COLUMN 87     PIC 9999 SOURCE INV-YR.
02 COLUMN 92     PIC 9(6) SOURCE INVOICE-NUMBER.
02 COLUMN 99     PIC $$$,$$$,$$$$.99-
                  SOURCE INVOICE-SALES.
02 DETAIL-COUNT PIC S9(10) SOURCE ONE-COUNT.
02 INV-AMOUNT   PIC S9(9)V99 SOURCE INVOICE-SALES.
01      TYPE IS CONTROL FOOTING NAME
        NEXT GROUP IS PLUS 2.
02      LINE IS PLUS 2.
03      COLUMN 73
        PIC X(39) VALUE ALL "*".
02      LINE IS PLUS 1.
03      COLUMN 20 PIC X(17) VALUE " TOTAL RECORDS: ".
03 IDC  COLUMN 40 PIC ZZZ,ZZZ,ZZ9 SUM ONE-COUNT.
03      COLUMN 73 PIC X(22) VALUE "* INVOICE SUB TOTAL: ".
03 IIA  COLUMN 96 PIC $$$,$$$,$$$$.99- SUM INVOICE-SALES.
03      COLUMN 111 PIC X VALUE "*".
02      LINE IS PLUS 1.
03      COLUMN 73
        PIC X(39) VALUE ALL "*".
01      FINAL-FOOTING TYPE IS CONTROL FOOTING FINAL
        NEXT GROUP NEXT PAGE.
02      LINE IS PLUS 2.
03      COLUMN 70
        PIC X(42) VALUE ALL "*".
02      LINE IS PLUS 1.
03      COLUMN 14 PIC X(21) VALUE "GRAND TOTAL RECORDS: ".
03 FDC  COLUMN 40 PIC ZZZ,ZZZ,ZZ9 SUM IDC.
03      COLUMN 70 PIC X(24) VALUE "* GRAND TOTAL INVOICES:".
03 FIA  COLUMN 94 PIC $,$$$,$$$,$$$$.99- SUM IIA.
03      COLUMN 111 PIC X VALUE "*".
02      LINE IS PLUS 1.
03      COLUMN 70
        PIC X(42) VALUE ALL "*".

```

(continued on next page)

## Producing Printed Reports 10.9 Report Writer Examples

### Example 10-10 (Cont.) Sample Program EX1010

```
01 REPORT-FOOTER TYPE IS REPORT FOOTING.
02 LINE 24 ON NEXT PAGE COLUMN 45
    PIC X(31) VALUE ALL "*".
02 LINE 25.
03 COLUMN 45
    PIC X VALUE "*".
03 COLUMN 75
    PIC X VALUE "*".
02 LINE 26.
03 COLUMN 45
    PIC X(31) VALUE "*" Customer Master File "*".
02 LINE 27.
03 COLUMN 45
    PIC X VALUE "*".
03 COLUMN 75
    PIC X VALUE "*".
02 LINE 28.
03 COLUMN 45
    PIC X VALUE "*".
03 COLUMN 55
    PIC Z9
    SOURCE UE-DAY.
03 COLUMN 57
    PIC X VALUE "-".
03 COLUMN 58
    PIC 99
    SOURCE UE-MONTH.
03 COLUMN 60
    PIC X VALUE "-".
03 COLUMN 61
    PIC 9999
    SOURCE UE-YEAR.
03 COLUMN 75
    PIC X VALUE "*".
02 LINE 29.
03 COLUMN 45
    PIC X VALUE "*".
03 COLUMN 75
    PIC X VALUE "*".
02 LINE 30 COLUMN 45
    PIC X(31) VALUE "*" End of Report EX1010 "*".
02 LINE 31.
03 COLUMN 45
    PIC X VALUE "*".
03 COLUMN 75
    PIC X VALUE "*".
02 LINE 32 COLUMN 45
    PIC X(31) VALUE ALL "*".

01 PAGE-FOOTING TYPE IS PAGE FOOTING.
02 LINE 59.
03 COLUMN 45
    PIC X(16) VALUE "C O M P A N Y ".
03 COLUMN 62
    PIC X(25) VALUE "C O N F I D E N T I A L ".
02 LINE 60.
03 COLUMN 45
    PIC X(16) VALUE "C O M P A N Y ".
03 COLUMN 62
    PIC X(25) VALUE "C O N F I D E N T I A L ".
```

(continued on next page)

## Producing Printed Reports

### 10.9 Report Writer Examples

#### Example 10–10 (Cont.) Sample Program EX1010

```
PROCEDURE DIVISION.  
DECLARATIVES.  
BOR SECTION.  
    USE BEFORE REPORTING REPORT-HEADER.  
EOR SECTION.  
    USE BEFORE REPORTING REPORT-FOOTER.  
EOR-A.  
    DISPLAY "**** Created EX1010.LIS ****".  
END DECLARATIVES.  
  
MAIN SECTION.  
000-DO-SORT.  
    SORT SORT-FILE ON ASCENDING KEY SORT-NAME  
    WITH DUPLICATES IN ORDER  
    USING CUSTOMER-FILE  
    GIVING SORTED-FILE.  
000-START.  
    DISPLAY "**** EX1010 ****".  
    DISPLAY "Enter Current Date (YYYYMMDD) :".  
    ACCEPT UNEDITED-DATE.  
    OPEN INPUT  SORTED-FILE.  
    OPEN OUTPUT PRINTER-FILE.  
    INITIATE MASTER-LIST.  
    PERFORM 200-READ-MASTER UNTIL NAME = HIGH-VALUES.  
100-END-OF-FILE.  
    TERMINATE MASTER-LIST.  
    CLOSE SORTED-FILE, PRINTER-FILE.  
    STOP RUN.  
200-READ-MASTER.  
    READ SORTED-FILE AT END MOVE HIGH-VALUES TO NAME.  
    IF NAME NOT = HIGH-VALUES GENERATE MASTER-LIST.
```

Figure 10-19 EX1010.LIS Listing

```

*****
*
* Customer Master File
*
* 11-08-2000
*
* Report EX1010
* Summary Report
*
*
*****

```

CUSTOMER MASTER FILE REPORT PAGE 2

NAME			ADDRESS			INVOICE				
LAST	FIRST	MI	STREET	CITY	ST	ZIP	DATE	NUMBER	AMOUNT	
TOTAL RECORDS:			7			* INVOICE SUB TOTAL: \$70,006.30 *				
TOTAL RECORDS:			1			* INVOICE SUB TOTAL: \$21,008.90 *				
TOTAL RECORDS:			1			* INVOICE SUB TOTAL: \$61,009.00 *				
TOTAL RECORDS:			6			* INVOICE SUB TOTAL: \$60,004.26 *				
TOTAL RECORDS:			1			* INVOICE SUB TOTAL: \$24,101.00 *				
TOTAL RECORDS:			1			* INVOICE SUB TOTAL: \$70,000.17 *				
TOTAL RECORDS:			3			* INVOICE SUB TOTAL: \$30,000.00 *				
TOTAL RECORDS:			1			* INVOICE SUB TOTAL: \$12,340.70 *				

C O M P A N Y C O N F I D E N T I A L  
C O M P A N Y C O N F I D E N T I A L

CUSTOMER MASTER FILE REPORT PAGE 3

NAME			ADDRESS			INVOICE				
LAST	FIRST	MI	STREET	CITY	ST	ZIP	DATE	NUMBER	AMOUNT	
TOTAL RECORDS:			1			* INVOICE SUB TOTAL: \$41,000.90 *				
TOTAL RECORDS:			1			* INVOICE SUB TOTAL: \$12,341.60 *				
TOTAL RECORDS:			1			* INVOICE SUB TOTAL: \$16,789.00 *				
TOTAL RECORDS:			1			* INVOICE SUB TOTAL: \$23,416.76 *				
TOTAL RECORDS:			1			* INVOICE SUB TOTAL: \$34,167.80 *				
TOTAL RECORDS:			1			* INVOICE SUB TOTAL: \$12,341.67 *				
TOTAL RECORDS:			1			* INVOICE SUB TOTAL: \$66,688.90 *				
TOTAL RECORDS:			1			* INVOICE SUB TOTAL: \$11,114.90 *				

C O M P A N Y C O N F I D E N T I A L  
C O M P A N Y C O N F I D E N T I A L

VM-0664A-AI

(continued on next page)

# Producing Printed Reports

## 10.9 Report Writer Examples

Figure 10–19 (Cont.) EX1010.LIS Listing

CUSTOMER MASTER FILE REPORT										PAGE 4
NAME			ADDRESS				INVOICE			
LAST	FIRST	MI	STREET	CITY	ST	ZIP	DATE	NUMBER	AMOUNT	
TOTAL RECORDS:			1		* INVOICE SUB TOTAL:			\$87,690.00		*
TOTAL RECORDS:			1		* INVOICE SUB TOTAL:			\$6.00		*
TOTAL RECORDS:			1		* INVOICE SUB TOTAL:			\$78,900.00		*
GRAND TOTAL RECORDS:			32		* GRAND TOTAL INVOICES:			\$732,927.86		*
COMPANY CONFIDENTIAL COMPANY CONFIDENTIAL ***** * Customer Master File * * 11-08-2000 * * End of Report EX1010 * * *****										

VM-0684B-AI

## 10.10 Solving Report Problems

Several variations to the basic report format are discussed in the next sections.

### 10.10.1 Printing More Than One Logical Line on a Single Physical Line

When your report has only a few columns, you can print several logical lines on one physical line. If you were to print names and addresses on four-up self-sticking multilabel forms, you would print the form left to right and top to bottom, as shown in Figure 10–20 and Example 10–11. To print four-up self-sticking labels, you must format each logical line with four input records.

However, if the columns must be sorted by column, the task becomes more difficult. The last line at the end of the first column is continued at the top of the second column of the same page, indented to the right, and so forth, as shown in Figure 10–21 and Example 10–12. Example 10–12 defines a table containing all data to appear on the page. It reads the input records, stores the data in the table as it is to appear on the page, prints the contents of the table and then fills spaces. When it reaches the end of file, the remaining entries in the table are automatically blank. You can extend this technique to print any number of logical lines on a single physical line.



Figure 10–20 Printing Labels Four-Up

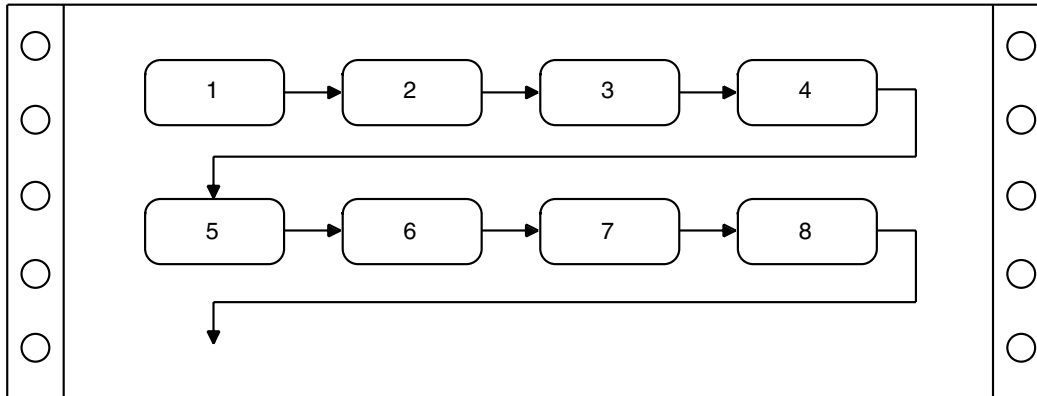

ZK-6088-GE

**Example 10–11 Printing Labels Four-Up**

```

IDENTIFICATION DIVISION.
PROGRAM-ID. REP02.
ENVIRONMENT DIVISION.
INPUT-OUTPUT SECTION.
FILE-CONTROL.
    SELECT INPUT-FILE ASSIGN TO "LABELS.DAT".
    SELECT REPORT-FILE ASSIGN TO "LABELS.REP".
DATA DIVISION.
FILE SECTION.
FD INPUT-FILE.
01 INPUT-RECORD.
    02 INPUT-NAME PIC X(20).
    02 INPUT-ADDRESS PIC X(15).
    02 INPUT-CITY PIC X(10).
    02 INPUT-STATE PIC XX.
    02 INPUT-ZIP PIC 99999.
FD REPORT-FILE.
01 REPORT-RECORD PIC X(132).
WORKING-STORAGE SECTION.
01 LABELS-TABLE.
    03 NAME-LINE.
        05 LINE-1 OCCURS 4 TIMES INDEXED BY INDEX-1.
            07 LABEL-NAME PIC X(20).
            07 FILLER PIC X(10).
    03 ADDRESS-LINE.
        05 LINE-2 OCCURS 4 TIMES INDEXED BY INDEX-2.
            07 LABEL-ADDRESS PIC X(15).
            07 FILLER PIC X(15).
    03 CSZ-LINE.
        05 LINE-3 OCCURS 4 TIMES INDEXED BY INDEX-3.
  
```

(continued on next page)

## Producing Printed Reports

### 10.10 Solving Report Problems

#### Example 10–11 (Cont.) Printing Labels Four-Up

```
          07 LABEL-CITY      PIC X(10).
          07 FILLER          PIC XXXX.
          07 LABEL-STATE    PIC XX.
          07 FILLER          PIC XXXX.
          07 LABEL-ZIP      PIC 99999.
          07 FILLER          PIC XXXXX.
01  END-OF-FILE              PIC X.
PROCEDURE DIVISION.
A000-BEGIN.
      OPEN INPUT  INPUT-FILE
          OUTPUT REPORT-FILE.
      MOVE SPACES TO LABELS-TABLE.
      SET INDEX-1, INDEX-2, INDEX-3 TO 1.
      PERFORM A100-READ-INPUT UNTIL END-OF-FILE = "Y".
A050-WRAP-UP.
      IF LABEL-NAME(1) IS NOT EQUAL TO SPACES
          PERFORM A300-PRINT-FOUR-LABELS.
A050-END-OF-JOB.
      CLOSE INPUT-FILE
          REPORT-FILE.
      DISPLAY "END OF JOB".
      STOP RUN.
*
A100-READ-INPUT.
      READ INPUT-FILE AT END MOVE "Y" TO END-OF-FILE.
      IF END-OF-FILE = "Y" NEXT SENTENCE
          ELSE PERFORM A200-GENERATE-TABLE.
*
A200-GENERATE-TABLE.
      MOVE INPUT-NAME      TO LABEL-NAME(INDEX-1)
      MOVE INPUT-ADDRESS  TO LABEL-ADDRESS(INDEX-2)
      MOVE INPUT-CITY     TO LABEL-CITY(INDEX-3)
      MOVE INPUT-STATE    TO LABEL-STATE(INDEX-3)
      MOVE INPUT-ZIP      TO LABEL-ZIP(INDEX-3)
      IF INDEX-1 = 4 PERFORM A300-PRINT-FOUR-LABELS
          ELSE          SET INDEX-1, INDEX-2, INDEX-3 UP BY 1.
*
A300-PRINT-FOUR-LABELS.
      WRITE REPORT-RECORD FROM NAME-LINE AFTER ADVANCING 3.
      WRITE REPORT-RECORD FROM ADDRESS-LINE AFTER ADVANCING 1.
      WRITE REPORT-RECORD FROM CSZ-LINE AFTER ADVANCING 1.
      MOVE SPACES TO LABELS-TABLE.
      SET INDEX-1, INDEX-2, INDEX-3 TO 1.
```

Figure 10-21 Printing Labels Four-Up in Sort Order

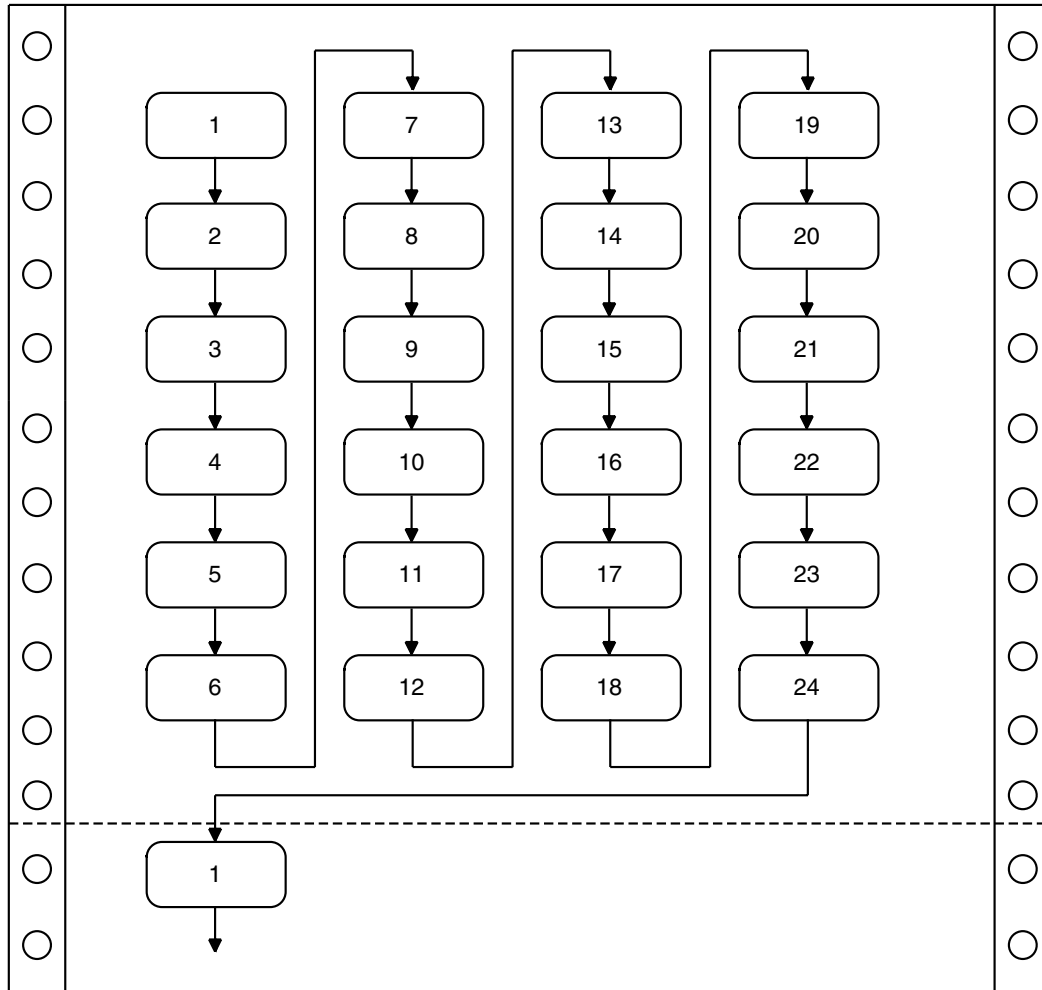

ZK-1556-GE

**Example 10-12 Printing Labels Four-Up in Sort Order**

```
IDENTIFICATION DIVISION.  
PROGRAM-ID. REP03.  
ENVIRONMENT DIVISION.  
INPUT-OUTPUT SECTION.  
FILE-CONTROL.  
    SELECT INPUT-FILE  ASSIGN TO "LABELS.DAT".  
    SELECT REPORT-FILE ASSIGN TO "LABELS.REP".
```

(continued on next page)

## Producing Printed Reports

### 10.10 Solving Report Problems

#### Example 10–12 (Cont.) Printing Labels Four-Up in Sort Order

```
DATA DIVISION.
FILE SECTION.
FD INPUT-FILE.
01 INPUT-RECORD.
   02 INPUT-NAME          PIC X(20).
   02 INPUT-ADDRESS      PIC X(15).
   02 INPUT-CITY         PIC X(10).
   02 INPUT-STATE        PIC XX.
   02 INPUT-ZIP          PIC 99999.
FD REPORT-FILE.
01 REPORT-RECORD        PIC X(132).
WORKING-STORAGE SECTION.
01 LABELS-TABLE.
   03 FOUR-UP OCCURS 6 TIMES INDEXED BY ROW-INDEX.
     04 NAME-LINE.
       05 LINE-1 OCCURS 4 TIMES INDEXED BY NAME-INDEX.
         07 LABEL-NAME    PIC X(20).
         07 FILLER        PIC X(10).
     04 ADDRESS-LINE.
       05 LINE-2 OCCURS 4 TIMES INDEXED BY ADDRESS-INDEX.
         07 LABEL-ADDRESS PIC X(15).
         07 FILLER        PIC X(15).
     04 CSZ-LINE.
       05 LINE-3 OCCURS 4 TIMES INDEXED BY CSZ-INDEX.
         07 LABEL-CITY    PIC X(10).
         07 FILLER        PIC XXXX.
         07 LABEL-STATE   PIC XX.
         07 FILLER        PIC XXXX.
         07 LABEL-ZIP     PIC 99999.
         07 FILLER        PIC XXXXX.
01 END-OF-FILE          PIC X.
PROCEDURE DIVISION.
A000-BEGIN.
   OPEN INPUT INPUT-FILE
   OUTPUT REPORT-FILE.
   MOVE SPACES TO LABELS-TABLE.
   SET ROW-INDEX, NAME-INDEX, ADDRESS-INDEX, CSZ-INDEX TO 1.
   PERFORM A100-READ-INPUT UNTIL END-OF-FILE = "Y".
A050-WRAP-UP.
   IF LABEL-NAME(1, 1) IS NOT EQUAL TO SPACES
   PERFORM A300-PRINT-PAGE-OF-LABELS VARYING ROW-INDEX
   FROM 1 BY 1 UNTIL ROW-INDEX IS GREATER THAN 6.
A050-END-OF-JOB.
   CLOSE INPUT-FILE
   REPORT-FILE.
   DISPLAY "END OF JOB".
   STOP RUN.
```

(continued on next page)

**Example 10–12 (Cont.) Printing Labels Four-Up in Sort Order**

```

A100-READ-INPUT.
  READ INPUT-FILE AT END MOVE "Y" TO END-OF-FILE.
  IF END-OF-FILE = "Y" NEXT SENTENCE
    ELSE PERFORM A200-GENERATE-LABELS.
A200-GENERATE-LABELS.
  MOVE INPUT-NAME      TO LABEL-NAME(ROW-INDEX, NAME-INDEX)
  MOVE INPUT-ADDRESS   TO LABEL-ADDRESS(ROW-INDEX, ADDRESS-INDEX)
  MOVE INPUT-CITY      TO LABEL-CITY(ROW-INDEX, CSZ-INDEX)
  MOVE INPUT-STATE     TO LABEL-STATE(ROW-INDEX, CSZ-INDEX)
  MOVE INPUT-ZIP       TO LABEL-ZIP(ROW-INDEX, CSZ-INDEX)
  IF ROW-INDEX = 6 AND NAME-INDEX = 4
    PERFORM A300-PRINT-PAGE-OF-LABELS VARYING ROW-INDEX
      FROM 1 BY 1 UNTIL ROW-INDEX IS GREATER THAN 6
    MOVE SPACES TO LABELS-TABLE
    SET ROW-INDEX, NAME-INDEX, ADDRESS-INDEX, CSZ-INDEX TO 1
  ELSE
    PERFORM A210-UPDATE-INDEXES.
A210-UPDATE-INDEXES.
  IF ROW-INDEX = 6 SET ROW-INDEX      TO 1
                   SET NAME-INDEX
                   ADDRESS-INDEX
                   CSZ-INDEX      UP BY 1
  ELSE
    SET ROW-INDEX UP BY 1.
A300-PRINT-PAGE-OF-LABELS.
  WRITE REPORT-RECORD FROM NAME-LINE(ROW-INDEX)
    AFTER ADVANCING 3.
  WRITE REPORT-RECORD FROM ADDRESS-LINE(ROW-INDEX)
    AFTER ADVANCING 1.
  WRITE REPORT-RECORD FROM CSZ-LINE(ROW-INDEX)
    AFTER ADVANCING 1.

```

**10.10.2 Group Indicating**

The group indicating process greatly improves a report's readability where long sequences of entries have some element in common. You print the element once, then leave it blank for subsequent lines, as long as there is no change in that element. For example, if your sample file's sort sequence is State (major key) and City (minor key), you get sequences like those in Table 10–2.

**Table 10–2 Results of Group Indicating**

Without Group Indicating			With Group Indicating		
STATE	CITY	STORE NUMBER	STATE	CITY	STORE NUMBER
Arizona	Grand Canyon	111111	Arizona	Grand Canyon	111111
Arizona	Grand Canyon	123456			123456
Arizona	Grand Canyon	222222			222222
Arizona	Tucson	333333	Arizona	Tucson	333333
Arizona	Tucson	444444			444444
Arizona	Tucson	555555			555555

(continued on next page)

## Producing Printed Reports

### 10.10 Solving Report Problems

**Table 10–2 (Cont.) Results of Group Indicating**

Without Group Indicating			With Group Indicating		
STATE	CITY	STORE NUMBER	STATE	CITY	STORE NUMBER
Massachusetts	Maynard	111111	Massachusetts	Maynard	111111
Massachusetts	Maynard	222222			222222
Massachusetts	Maynard	333333			333333
Massachusetts	Maynard	444444			444444
Massachusetts	Tewksbury	111111	Massachusetts	Tewksbury	111111
Massachusetts	Tewksbury	222222			222222
New Hampshire	Manchester	111111	New Hampshire	Manchester	111111
New Hampshire	Manchester	222222			222222
New Hampshire	Merrimack	333333	New Hampshire	Merrimack	333333
New Hampshire	Merrimack	444444			444444
New Hampshire	Merrimack	555555			555555
New Hampshire	Nashua	666666	New Hampshire	Nashua	666666

#### 10.10.3 Fitting Reports on the Page

If you need more columns than physically can fit on a page, you can do the following:

- Eliminate as many unused spaces as possible between columns. Columns should not be run together; however, you can use one blank space instead of several.
- Eliminate nonessential information.
- Print two or more lines with staggered headers and columns.
- Print two reports.

#### 10.10.4 Printing Totals Before Detail Lines

A report that must include totals at the top of the page before the detail lines has three solutions as follows:

- Store the logical print lines in a table, total the table, and then print from the table.
- Pass through the file twice. The first time, compute the totals. The second time, print the report. This method is slow and complicated if there are many subtotals.
- Write the lines into a file with a sort key containing the report, page, and line number. When your program writes the last line and computes the total, have it assign a page and line number to the total line's sort key. Use an appropriate page and line number to cause the total line to sort in front of its detail lines. After the program completes, sort the file, read it, drop the sort key, and produce the report.

### 10.10.5 Underlining Items in Your Reports

The examples in this section apply only to printers that support overprinting.

Sometimes you must underline a column of numbers to denote a total and also underline the total to highlight it:

```
1234
1122
----
2356
=====
```

To print a single underline, use the underscore character and suppress line spacing. For example:

```
WRITE PRINT-LINE FROM SINGLE-UNDERLINE-TOTAL
      BEFORE ADVANCING 0 LINES.
```

This overprints the underscore ( `_` ) on the previous line, underlining the item: 1122. Use the equal sign ( `=` ) to simulate double underlines. Note that you must write the equal signs on the next line. For example:

```
WRITE PRINT-LINE FROM DOUBLE-UNDERLINE-TOTAL
      AFTER ADVANCING 1 LINE.
```

### 10.10.6 Bolding Items in Your Reports

The examples in this section apply only to printers that support overprinting.

To bold an entire line in a report:

1. Write the line as many times as you want, specifying the `BEFORE ADVANCING 0 LINES` phrase (three times is sufficient). This darkens the line but does not advance to the next line.
2. Write the line one last time without the `BEFORE ADVANCING` phrase. This overprints the line again and advances to the next print line.

For example:

```
WRITE PRINT-LINE FROM TOTAL-LINE BEFORE ADVANCING 0 LINES.
WRITE PRINT-LINE FROM TOTAL-LINE BEFORE ADVANCING 0 LINES.
WRITE PRINT-LINE FROM TOTAL-LINE BEFORE ADVANCING 0 LINES.
WRITE PRINT-LINE FROM TOTAL-LINE.
```

This example produces a darker image in the report. You can use similar statements for characters and words, as well as complete lines. To bold only a word or only a character within a line, you must:

1. Write the print line and specify the `BEFORE ADVANCING 0 LINES` phrase.
2. Use reference modification to create a skeleton line containing only the items in the print line you want bolded.
3. Write the skeleton line as many times as you want and specify the `BEFORE ADVANCING 0 LINES` phrase. This darkens the items in the skeleton line but does not advance to the next line.
4. Write the skeleton line one last time without the `BEFORE ADVANCING` phrase. This overprints the line again and advances to the next print line.

## Producing Printed Reports

### 10.10 Solving Report Problems

For example:

```
        WRITE PRINT-LINE FROM TOTAL-LINE BEFORE ADVANCING 0 LINES.  
*  
* Move spaces over the items in the source print line (TOTAL-LINE)  
* that are not to be bolded  
*  
        MOVE SPACES TO ...  
        WRITE PRINT-LINE FROM TOTAL-LINE BEFORE ADVANCING 0 LINES.  
        WRITE PRINT-LINE FROM TOTAL-LINE BEFORE ADVANCING 0 LINES.  
        WRITE PRINT-LINE FROM TOTAL-LINE.
```



---

## Using ACCEPT and DISPLAY Statements for Input/Output and Video Forms

ACCEPT and DISPLAY statements are used to make low-volume data available to specified devices. You will find the following information useful:

- Section 11.1 describes the use of the ACCEPT and DISPLAY statements for interactive I/O.
- Section 11.2 explains how you can design an online video form similar to a printed form by using the Hewlett-Packard extensions to the ACCEPT and DISPLAY statements.
- Section 11.3 describes the X/Open Screen Section features. You can use it to design video forms easily and efficiently in a single section of your COBOL program, and then accept or display a full screen of data with a single ACCEPT statement or DISPLAY statement.

### 11.1 Using ACCEPT and DISPLAY for I/O

The COBOL language provides two statements, ACCEPT and DISPLAY, for low-volume I/O operations. The ACCEPT and DISPLAY statements transfer data between your program and the standard input and output devices. If you do not use the FROM or UPON phrases, or an environment variable, the default device for ACCEPT is the keyboard and the default device for DISPLAY is the terminal screen.

The FROM or UPON phrases refer to mnemonic names that you can define in the Environment Division SPECIAL-NAMES paragraph. You define a mnemonic name by equating it to a COBOL implementor name; for example, the following clause equates STATUS-REPORT to the device LINE-PRINTER:

```
LINE-PRINTER IS STATUS-REPORT
```

You can then use the mnemonic name in a DISPLAY statement:

```
DISPLAY "File contains " REC-COUNT UPON STATUS-REPORT.
```

The COBOL implementor names in the SPECIAL-NAMES paragraph refer to special HP COBOL environment variables or logical names. Environment variables or logical names do not always represent physical devices.

On the Tru64 UNIX operating system, you can assign an environment variable to a file name as follows:

```
% setenv COBOL_LINEPRINTER status.lis ◆
```

## Using ACCEPT and DISPLAY Statements for Input/Output and Video Forms

### 11.1 Using ACCEPT and DISPLAY for I/O

On OpenVMS, you can assign a logical name to a file specification using the ASSIGN command (or the DEFINE command, with the arguments in reverse order):

```
$ ASSIGN [ALLSTATUS]STATUS.LIS COB$LINEPRINTER ◆
```

If you use an environment variable or a logical name, you must define it appropriately for the ACCEPT or DISPLAY statement to succeed.

On OpenVMS, when you run an application, if input and output are both directed to terminals, they must be directed to the same terminal. If input and output are directed to different terminals, the output terminal is used and the input terminal is ignored. ◆

For more information on the logical names or environment variables and the mnemonic names, refer to the SPECIAL-NAMES section in the Environment Division chapter in the *HP COBOL Reference Manual*.

#### ACCEPT Statement

On OpenVMS, the ACCEPT statement transfers data from the input device to a data item. If you do not use the FROM phrase, the system uses the logical name COB\$INPUT if it is defined, otherwise SYS\$INPUT. If you use the FROM phrase, it uses the logical name associated with the mnemonic-name in the FROM clause. ◆

On Tru64 UNIX, the ACCEPT statement transfers data from the input device to a data item. If you do not use the FROM phrase, the system uses the environment variable COBOL\_INPUT if it is defined, or stdin if COBOL\_INPUT is not otherwise defined. If you use the FROM phrase, the system uses the environment variable associated with the mnemonic-name in the FROM clause. ◆

The following example illustrates the FROM phrase used in conjunction with ACCEPT:

```
SPECIAL-NAMES.  
    CARD-READER IS WHATS-THE-NAME  
    .  
    .  
PROCEDURE DIVISION.  
    .  
    .  
    ACCEPT PARAMETER-AREA FROM WHATS-THE-NAME.
```

#### DISPLAY Statement

On OpenVMS, the DISPLAY statement transfers the contents of data items and literals to the output device. If you do not use the UPON phrase, the system uses the logical name COB\$OUTPUT if it is defined, or SYS\$OUTPUT if it is not defined. If you use the UPON phrase, the system uses the logical name associated with the mnemonic-name in the FROM clause. ◆

On Tru64 UNIX, the DISPLAY statement transfers the contents of data items and literals to the output device. If you do not use the UPON phrase, the system uses the environment variable COBOL\_OUTPUT if it is defined, or stdout if it is not defined. If you use the UPON phrase, the system uses the environment variable associated with the mnemonic-name in the UPON clause.

## Using ACCEPT and DISPLAY Statements for Input/Output and Video Forms

### 11.1 Using ACCEPT and DISPLAY for I/O

The following example illustrates the UPON phrase used in conjunction with DISPLAY:

```
SPECIAL-NAMES.  
    LINE-PRINTER IS ERROR-LOG  
    .  
    .  
    .  
PROCEDURE DIVISION.  
    .  
    .  
    .  
    DISPLAY ERROR-COUNT, " phase 2 errors, ", ERROR-MSG UPON ERROR-LOG.
```

## 11.2 Designing Video Forms with ACCEPT and DISPLAY Statement Extensions

The extended HP COBOL options to the ACCEPT and DISPLAY statements provide video forms features. You can develop video forms on VT100 and later series terminals and faithful emulators and write your application without regard to the type of terminal on which the application will eventually run. You can also run your forms application in the terminal emulator window of a workstation.<sup>1</sup>

Using the extended forms of the ACCEPT and DISPLAY statements, you can design video forms to:

- Make data entry applications, menu selections, and special control keys easier to use.
- Clarify the input expected from an operator.
- Improve the appearance of an application's terminal dialog.

Figure 11–1 is a sample form created by an HP COBOL program. It is for entry of employee information into a master file. This program prompts the user to type in data. Then the program writes it to the master file and displays a new form.

---

#### Note

---

The final appearance of screens depends upon the setting of your system display setup properties (for example, dark on light, or light on dark). The following figures are representative only.

---

For information on differences between the HP COBOL and the HP COBOL for OpenVMS VAX implementations of screen management, see Appendix B. For complete reference information on the ACCEPT and DISPLAY statements, including syntax, refer to the *HP COBOL Reference Manual*.

---

<sup>1</sup> HP COBOL does not provide mouse or split screen support.

# Using ACCEPT and DISPLAY Statements for Input/Output and Video Forms

## 11.2 Designing Video Forms with ACCEPT and DISPLAY Statement Extensions

Figure 11–1 Video Form to Gather Information for a Master File Record

```
1 2 3 4 5 6 7 8
1234567890123456789012345678901234567890123456789012345678901234567890
1
2
3 *****PERSONNEL MASTER FILE DATA INPUT FORM*****
4
5
6 Employee Number:  Wage Class: 
7
8 Employee Name: 
9
10 Employee Address: 
11
12 Employee Phone No.: 
13
14 Department: 
15
16 Supervisor Name: 
17
18 Supervisor Phone No.: 
19
20 Current Salary: $ 
21
22 Date Hired: / /  Next Review Date: / / 
23
24
```

ZK-6089-GE

### Designing Your Form with ACCEPT and DISPLAY Options

When you design a video form, you can use the ACCEPT and DISPLAY options to do the following:

- Erase specific parts or the entire screen.
- Use relative and absolute cursor positioning.
- Specify video attributes of data to be displayed and accepted.
- Convert data to appropriate usage when accepting or displaying data.
- Handle error conditions when accepting and displaying data.
- Provide screen protection by limiting the number of characters typed on the terminal when accepting data.
- Accept data without echoing.
- Specify default values for ACCEPT statements.
- Define and handle special control keys for ACCEPT statements.
- Allow field editing.

The remainder of this chapter describes these topics.

### 11.2.1 Clearing a Screen Area

To clear part or all of your screen before you accept or display data, you can use one of the following ERASE options of the ACCEPT and DISPLAY statements:

- ERASE SCREEN—Erase the entire screen before accepting or displaying data at the specified or implied cursor position.

## Using ACCEPT and DISPLAY Statements for Input/Output and Video Forms

### 11.2 Designing Video Forms with ACCEPT and DISPLAY Statement Extensions

- ERASE LINE—Erase the entire specified line before accepting or displaying data at the specified or implied cursor position.
- ERASE TO END OF SCREEN—Erase from the specified or implied cursor position to the end of the screen before accepting or displaying data at the specified cursor position.
- ERASE TO END OF LINE—Erase from the specified or implied cursor position to the end of the line before accepting or displaying data at the specified cursor position.

These options all work with either absolute or relative cursor positioning. (See Section 11.2.2.)

---

#### Note

---

On OpenVMS, for any application that displays or accepts information from a terminal, use the SET TERMINAL/NOBROADCAST command before you start the application. This command prevents broadcast messages (such as notifications of new mail) from interrupting the screen displays. ♦

---

In Example 11–1, an introductory message is first displayed on the screen (along with a prompt to the user). Then the ERASE SCREEN option causes the entire screen to be erased before "Employee number:" is displayed. Figure 11–2 shows how the screen looks after the ERASE statement executes.

#### Example 11–1 Erasing a Screen

```
IDENTIFICATION DIVISION.  
PROGRAM-ID. ERASEIT.  
DATA DIVISION.  
WORKING-STORAGE SECTION.  
01 ANY-CHAR          PIC X.  
PROCEDURE DIVISION.  
A00-BEGIN.  
    DISPLAY "EMPLOYEE ACCESS SYSTEM" LINE 8 COLUMN 30.  
    DISPLAY "Type any character to begin." LINE 20 COLUMN 10.  
    ACCEPT ANY-CHAR.  
A10-EN-SCREEN.  
    DISPLAY "Employee number:" LINE 4 COLUMN 4 ERASE SCREEN.  
    DISPLAY " " LINE 23 COLUMN 1.  
STOP RUN.
```

### 11.2.2 Horizontal and Vertical Positioning of the Cursor

To position data items at a specified line and column, use the LINE NUMBER and COLUMN NUMBER phrases. You can use these phrases with both the ACCEPT and DISPLAY statements. You can use literals or numeric data items to specify line and column numbers.

# Using ACCEPT and DISPLAY Statements for Input/Output and Video Forms

## 11.2 Designing Video Forms with ACCEPT and DISPLAY Statement Extensions

Figure 11–2 Screen After the ERASE Statement Executes

```
1 2 3 4 5 6 7 8
1234567890123456789012345678901234567890123456789012345678901234567890
1
2
3
4 Employee number:
5
6
7
8
9
10
11
12
13
14
15
16
17
18
19
20
21
22
23
24
```

ZK-6091-GE

### Example 11–2 Cursor Positioning

```
IDENTIFICATION DIVISION.
PROGRAM-ID. LOCATE.
ENVIRONMENT DIVISION.
DATA DIVISION.
WORKING-STORAGE SECTION.
01 COL-NUM PIC 99 VALUE 4.
PROCEDURE DIVISION.
A00-OUT-PARA.
    DISPLAY "Employee name:" LINE 19
                                COLUMN COL-NUM
                                ERASE SCREEN.

    DISPLAY " " LINE 24
                                COLUMN 1.

STOP RUN.
```

---

#### Note

---

The default initial cursor position is in the upper left corner of the screen. HP COBOL moves the cursor to this initial position just prior to the execution of the first ACCEPT or DISPLAY statement. This is true regardless of the format of the statement, unless you specify the cursor position.

---

In Example 11–2 and in Figure 11–3, "Employee name:" is displayed on line 19 starting in column 4.

# Using ACCEPT and DISPLAY Statements for Input/Output and Video Forms

## 11.2 Designing Video Forms with ACCEPT and DISPLAY Statement Extensions

Figure 11–3 Positioning the Data on Line 19, Column 5

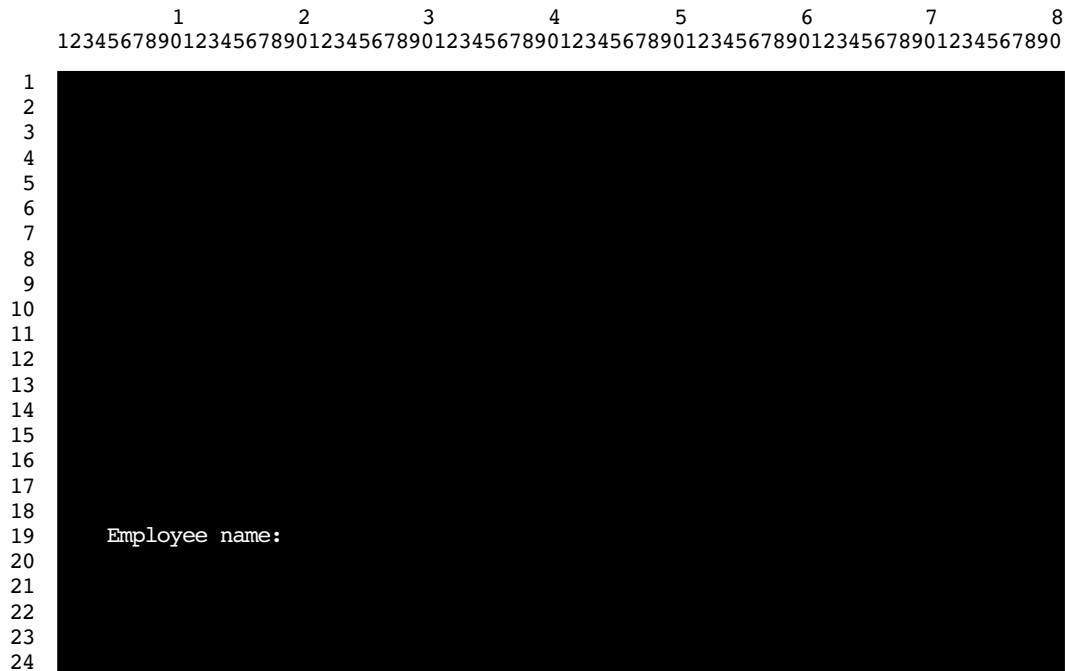

ZK-6092-GE

If you use `LINE`, but not `COLUMN`, data is accepted or displayed at column 1 of the specified line position.

If you use `COLUMN`, but not `LINE`, data is accepted or displayed at the current line and specified column position.

If you do not use either phrase, data is accepted or displayed at the position specified by the rules for Format 1 `ACCEPT` and `DISPLAY` in the *HP COBOL Reference Manual*.

### Note

The presence of either or both the `LINE` and `COLUMN` phrases implies `NO ADVANCING`.

You can use the `PLUS` option with the `LINE` or `COLUMN` phrases for relative cursor positioning. The `PLUS` option eliminates the need for counting lines or columns. Cursor positioning is relative to where the cursor is after the previous `ACCEPT` or `DISPLAY`. If you use the `PLUS` option without an integer, `PLUS 1` is implied.

To get predictable results from your relative cursor positioning statements, *do not*:

- Cause a display line to wrap around to the next line.
- Accept data into unprotected fields.
- Go beyond the top or bottom of the screen.
- Mix displays of double-high characters and relative cursor positioning.

# Using ACCEPT and DISPLAY Statements for Input/Output and Video Forms

## 11.2 Designing Video Forms with ACCEPT and DISPLAY Statement Extensions

In Example 11–3, the PLUS phrase is used twice to show relative positioning, once with an integer, and once without. Figure 11–4 shows the results.

### Example 11–3 Using PLUS for Cursor Positioning

```
IDENTIFICATION DIVISION.  
PROGRAM-ID. LINEPLUS.  
PROCEDURE DIVISION.  
A00-BEGIN.  
    DISPLAY "Positioning Test" LINE 10      COLUMN 20 ERASE SCREEN  
        "Changing Test"   LINE PLUS 5    COLUMN PLUS 26  
        "Adding Test"     LINE PLUS      COLUMN PLUS 14.  
    DISPLAY " " LINE 23 COLUMN 1.  
    STOP RUN.
```

---

#### Note

---

If you use the LINE PLUS phrase so relative positioning goes beyond the bottom of the screen, your form scrolls with each such display.

---

Figure 11–4 Cursor Positioning Using the PLUS Option

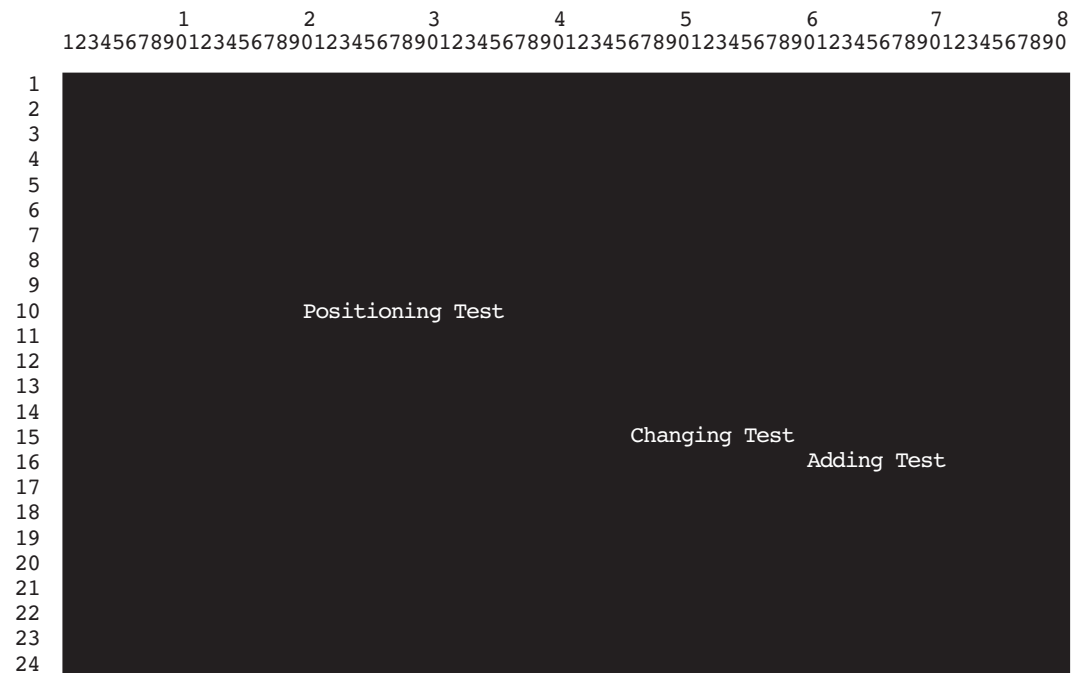

ZK-6120-GE

### 11.2.3 Assigning Character Attributes to Your Format Entries

Depending on your terminal type, you can use one or more of the character attributes in Table 11–1 to highlight your screen data. Example 11–4 shows the use of these attributes in a program segment. Figure 11–5 shows the results of the program segment in Example 11–4.



## Using ACCEPT and DISPLAY Statements for Input/Output and Video Forms

### 11.2 Designing Video Forms with ACCEPT and DISPLAY Statement Extensions

Table 11–1 Available Character Attributes by Terminal Type

Character Attribute	VT500, VT400, VT300, VT200, and VT100 with Advanced Video Option	VT100 Without Advanced Video Option
BELL Sounds the terminal bell	Available	Available
UNDERLINED Underlines the text	Available	Not Available
BOLD Intensifies the text	Available	Not Available
BLINKING Blinks the text	Available	Not Available
REVERSED Changes the text's foreground & background colors	Available	Not Available

#### Example 11–4 Using Character Attributes

```
IDENTIFICATION DIVISION.  
PROGRAM-ID. CHARATTR.  
PROCEDURE DIVISION.  
A00-BEGIN.  
    DISPLAY "Employee No:" UNDERLINED LINE 5 COLUMN 5 ERASE SCREEN.  
    DISPLAY "Employee wage class:" BOLD LINE 5 COLUMN 25.  
    DISPLAY "NAME" BLINKING LINE PLUS 6 COLUMN 6.  
    DISPLAY "SALARY: $" REVERSED LINE PLUS 6 COLUMN 24.  
    DISPLAY " " LINE 23 COLUMN 1.
```

#### 11.2.4 Using the CONVERSION Phrase to Display Numeric Data

Use the CONVERSION phrase to convert the value of a numeric data item for display. It causes the value to appear on the screen as follows:

- In DISPLAY usage
- With a decimal point (if needed) or comma (if DECIMAL-POINT IS COMMA)
- Edited (if needed)
- With a sign (if needed)

Thus, the values of non-DISPLAY data items can be converted to a readable form. The size of the displayed field is determined by the PICTURE clause of the displayed item. Example 11–5 and Figure 11–6 show how to display different types of data with the CONVERSION phrase.

# Using ACCEPT and DISPLAY Statements for Input/Output and Video Forms

## 11.2 Designing Video Forms with ACCEPT and DISPLAY Statement Extensions

Figure 11–5 Screen Display with Character Attributes

```

1      1      2      3      4      5      6      7      8
1234567890123456789012345678901234567890123456789012345678901234567890
1
2
3
4
5      Employee No.:      Employee wage class:
6
7
8
9
10
11     NAME
12
13
14
15
16
17     SALARY: $
18
19
20
21
22
23
24

```

ZK-6093-GE

### Example 11–5 Using the CONVERSION Phrase

```

IDENTIFICATION DIVISION.
PROGRAM-ID. CONVERT.
ENVIRONMENT DIVISION.
DATA DIVISION.
WORKING-STORAGE SECTION.
01 DATA1A PIC X(10).
01 DATA1B PIC X(10) JUST.
01 DATA2 PIC +++++9999.99.
01 DATA3 PIC S9(2)V9(2) COMP.
01 DATA4 PIC S9(3)V9(3) COMP.
01 DATA5 PIC S9(6)V9(6) COMP.
01 DATA6 PIC S9(4)V9(4) COMP-3.
01 DATA7 PIC S9(1)V9(7) SIGN LEADING SEPARATE.
PROCEDURE DIVISION.
CONVERT-CHECK SECTION.
P1.
    DISPLAY "to begin... press your carriage Return key"
        LINE 1 COLUMN 1 ERASE SCREEN
        BELL UNDERLINED REVERSED.
ACCEPT DATA1A.

```

(continued on next page)

## Using ACCEPT and DISPLAY Statements for Input/Output and Video Forms

### 11.2 Designing Video Forms with ACCEPT and DISPLAY Statement Extensions

#### Example 11-5 (Cont.) Using the CONVERSION Phrase

```
DISPLAY "X(10) Test" LINE 8 ERASE LINE.
ACCEPT DATA1A WITH CONVERSION PROTECTED REVERSED
LINE 8 COLUMN 50.
DISPLAY DATA1A REVERSED WITH CONVERSION
LINE 8 COLUMN 65.
DISPLAY "X(10) JUSTIFIED Test" LINE 10 ERASE LINE.
ACCEPT DATA1B WITH CONVERSION PROTECTED REVERSED
LINE 10 COLUMN 50.
DISPLAY DATA1B REVERSED WITH CONVERSION
LINE 10 COLUMN 65.
P2.
DISPLAY "Num edited Test (+++++9999.99):" LINE 12 ERASE LINE.
ACCEPT DATA2 PROTECTED REVERSED WITH CONVERSION
LINE 12 COLUMN 50.
DISPLAY DATA2 REVERSED WITH CONVERSION
LINE 12 COLUMN 65.
P3.
DISPLAY "Num COMP Test S9(2)V9(2):" LINE 14 ERASE LINE.
ACCEPT DATA3 PROTECTED REVERSED WITH CONVERSION
LINE 14 COLUMN 50.
DISPLAY DATA3 REVERSED WITH CONVERSION LINE 14 COLUMN 65.
P4.
DISPLAY "Num COMP Test S9(3)V9(3):" LINE 16 ERASE LINE.
ACCEPT DATA4 PROTECTED REVERSED WITH CONVERSION
LINE 16 COLUMN 50.
DISPLAY DATA4 REVERSED WITH CONVERSION
LINE 16 COLUMN 65.
P5.
DISPLAY "Num COMP Test S9(6)V9(6):" LINE 18 ERASE LINE.
ACCEPT DATA5 PROTECTED REVERSED WITH CONVERSION
LINE 18 COLUMN 50.
DISPLAY DATA5 REVERSED WITH CONVERSION
LINE 18 COLUMN 65.
P6.
DISPLAY "Num COMP-3 Test S9(4)V9(4):" LINE 20 ERASE LINE.
ACCEPT DATA6 PROTECTED REVERSED WITH CONVERSION
LINE 20 COLUMN 50.
DISPLAY DATA6 REVERSED WITH CONVERSION
LINE 20 COLUMN 65.
P7.
DISPLAY "Num DISPLAY Test S9(1)V9(7)Sign Lead Sep:"
LINE 22 ERASE LINE.
ACCEPT DATA7 PROTECTED REVERSED WITH CONVERSION
LINE 22 COLUMN 50.
DISPLAY DATA7 REVERSED WITH CONVERSION
LINE 22 COLUMN 65.
P8.
DISPLAY "To end...type END"
LINE PLUS COLUMN 1 ERASE LINE
BELL UNDERLINED REVERSED.
ACCEPT DATA1A.
IF DATA1A = "END" STOP RUN.
GO TO P1.
```

# Using ACCEPT and DISPLAY Statements for Input/Output and Video Forms

## 11.2 Designing Video Forms with ACCEPT and DISPLAY Statement Extensions

Figure 11–6 Sample Run of Program CONVERT

```

1234567890123456789012345678901234567890123456789012345678901234567890
1  to begin... press your carriage return key
2
3
4
5
6
7
8  X(10) Test                abcdef      abcdef
9
10 X(10) JUSTIFIED Test     abcdef      abcdef
11
12 Num edited Test (+++++9999.99): 1234567.8  +1234567.80
13
14 Num COMP Test S9(2)V9(2):  89.98-     -89.98
15
16 Num COMP Test S9(3)V9(3):  +103.6      103.600
17
18 Num COMP Test S9(6)V9(6):  65432.100009 65432.100009
19
20 Num COMP-3 Test S9(4)V9(4): 1234.1234   1234.1234
21
22 Num DISPLAY Test S9(1)V9(7)Sign Lead Sep: 6.0729375- -6.0729375
23 To end...type ENDEND
24

```

ZK-6094-GE

Note that, in addition to the items illustrated in Figure 11–6, you can also display the following:

- COMP-1 and COMP-2 data items
- On OpenVMS, RMS registers (RMS-STTS, RMS-STV, RMS-FILENAME, RMS-CURRENT-STTS, RMS-CURRENT-STV, RMS-CURRENT-FILENAME) ♦
- LINAGE-COUNTER register
- RETURN-CODE special register
- RWCS registers (PAGE-COUNTER, LINE-COUNTER)
- VALUE EXTERNAL data items
- POINTER VALUE REFERENCE data items

The /DISPLAY\_FORMATTED command-line qualifier is an alternative way to display numeric data without specifying the CONVERSION phrase. It accomplishes the same result, converting any nonprinting values for display. (The default is /NODISPLAY\_FORMATTED.)

### 11.2.5 Handling Data with ACCEPT Options

The ACCEPT options CONVERSION, ON EXCEPTION, PROTECTED, SIZE, NO ECHO, and DEFAULT are described in the following sections.

## Using ACCEPT and DISPLAY Statements for Input/Output and Video Forms

### 11.2 Designing Video Forms with ACCEPT and DISPLAY Statement Extensions

#### 11.2.5.1 Using CONVERSION with ACCEPT Data

When you use the CONVERSION phrase with an ACCEPT numeric operand (other than floating point), HP COBOL converts the data entered on the form to a trailing-signed decimal field. Editing is performed when specified by destination. The data is then moved from the screen to your program using standard MOVE statement rules.

When you use the CONVERSION phrase with an ACCEPT numeric floating-point operand, HP COBOL converts input data to floating-point (COMP-1 or COMP-2 as appropriate). The converted result is then moved to the destination as if moving a numeric literal equivalent to the input data with the MOVE statement.

When an ACCEPT operand is not numeric, the CONVERSION phrase moves the input characters as an alphanumeric string, using standard MOVE statement rules. This lets you accept data into an alphanumeric-edited or JUSTIFIED field.

If you use the CONVERSION phrase while accepting numeric data, you can also use the ON EXCEPTION phrase to control data entry errors.

If you do not use the CONVERSION phrase, data is transferred to the destination item according to Format 1 ACCEPT statement rules.

#### 11.2.5.2 Using ON EXCEPTION When Accepting Data with CONVERSION

If you enter illegal numeric data or exceed the PICTURE description (if not protected) of the ACCEPT data (with an overflow to either the left or right of the decimal point), the imperative statement associated with ON EXCEPTION executes, and the destination field does not change.

Example 11–6 (and Figure 11–7) show how the ON EXCEPTION phrase executes if you enter an alphanumeric or a numeric item out of the valid range. The statements following ON EXCEPTION prompt you to try again.

If you do not use ON EXCEPTION and a conversion error occurs:

- The field on the screen is filled with spaces.
- The terminal bell rings and the terminal automatically reprompts you for the data results.

A DISPLAY statement within an ACCEPT [NOT] ON EXCEPTION statement must be terminated, with, for example, END-DISPLAY.

#### 11.2.5.3 Protecting the Screen

You can use the PROTECTED phrase in an ACCEPT statement to limit the number of characters that can be entered. This phrase prevents overwriting or deleting parts of the screen. For more information about using the PROTECTED phrase, refer to the ACCEPT statement in the *HP COBOL Reference Manual*.

If you use this phrase, and you try to type past the rightmost position of the input field or delete past the left edge of the input field, the terminal bell sounds and the screen cursor does not move. You can accept the data on the screen by pressing a legal terminator key, or you can delete the data by pressing the DELETE key. If you specify PROTECTED WITH AUTOTERMINATE, the ACCEPT operation terminates when the maximum number of characters has

# Using ACCEPT and DISPLAY Statements for Input/Output and Video Forms

## 11.2 Designing Video Forms with ACCEPT and DISPLAY Statement Extensions

### Example 11–6 Using the ON EXCEPTION Phrase

```

IDENTIFICATION DIVISION.
PROGRAM-ID. ONEXC.
ENVIRONMENT DIVISION.
DATA DIVISION.
WORKING-STORAGE SECTION.
01 NUM-DATA PIC S9(3)V9(3) COMP-3.
PROCEDURE DIVISION.
A00-BEGIN.
    DISPLAY "Enter any number in this range: -999.999 to +999.999"
        LINE 10 COLUMN 1
        ERASE SCREEN.
ACCEPT NUM-DATA WITH CONVERSION LINE 15 COLUMN 16
ON EXCEPTION
    DISPLAY "Valid range is: -999.999 to +999.999"
        LINE 20 REVERSED WITH BELL ERASE TO END OF SCREEN
    DISPLAY
        "PLEASE try again... press your carriage return key to continue"
        LINE PLUS REVERSED
ACCEPT NUM-DATA
GO TO A00-BEGIN.
STOP RUN.

```

Figure 11–7 Accepting Data with the ON EXCEPTION Option

```

1234567890123456789012345678901234567890123456789012345678901234567890
1
2
3
4
5
6
7
8
9
10 Enter any number in this range: -999.999 to +999.999
11
12
13
14
15      1234.567-
16
17
18
19
20 Valid range is: -999.999 to +999.999
21 PLEASE try again... press your carriage return key to continue
22
23
24

```

ZK-6095-GE

been entered unless a terminator has been entered prior to this point. For more information on legal terminator keys, refer to the CONTROL KEY phrase of the ACCEPT statement in the *HP COBOL Reference Manual*.

You can also use the REVERSED, BOLD, BLINKING, or UNDERLINED attributes with the PROTECTED phrase. Using these attributes lets you see the size of the input field on the screen before you enter data. The characters you enter also echo the specified attribute.

## Using ACCEPT and DISPLAY Statements for Input/Output and Video Forms

### 11.2 Designing Video Forms with ACCEPT and DISPLAY Statement Extensions

You can specify the NO BLANK and FILLER phrases with the PROTECTED phrase. The NO BLANK phrase specifies that the protected input field is not to be filled with spaces until after the first character is entered. The FILLER phrase initializes each character position of the input field with the filler character specified.

When you use the FILLER phrase with the NO BLANK phrase, the input field is filled with the filler character only after you have entered the first character.

The PROTECTED SIZE phrase sets the size of the input field on the screen and allows you to change the size of the input field from the size indicated by the PICTURE phrase of the destination item. Example 11–7 and Figure 11–8 show how to use the SIZE phrase with the PROTECTED phrase. When the example specifies SIZE 3, any attempt to enter more than three characters makes the terminal bell ring. When the example specifies SIZE 10, the ACCEPT statement includes the ON EXCEPTION phrase to warn you whenever you enter a number that will result in truncation at either end of the assumed decimal point. Figure 11–8 shows such an example in which the operator entered a 10-digit number, exceeding the storage capacity of the data item NUM-DATA on the left side of the assumed decimal point.

---

#### Note

---

The SIZE phrase controls only the number of characters you can enter; it does not alter any other PICTURE clause requirements. Truncation, space or zero filling, and decimal point alignment occur according to MOVE statement rules only if CONVERSION is specified.

---

When you do not use the PROTECTED phrase, the amount of data transferred is determined according to the ACCEPT statement rules. (Refer to the *HP COBOL Reference Manual*.)

#### 11.2.5.4 Using NO ECHO with ACCEPT Data

By default, the characters you type at the terminal are displayed on the screen. Example 11–8 shows how you can use the NO ECHO phrase to prevent the input field from being displayed; thus, the NO ECHO phrase allows you to keep passwords and other information confidential.

# Using ACCEPT and DISPLAY Statements for Input/Output and Video Forms

## 11.2 Designing Video Forms with ACCEPT and DISPLAY Statement Extensions

### Example 11-7 Using the SIZE and PROTECTED Phrases

```

IDENTIFICATION DIVISION.
PROGRAM-ID. PROTECT.
ENVIRONMENT DIVISION.
DATA DIVISION.
WORKING-STORAGE SECTION.
01 NUM-DATA PIC S9(9)V9(9) COMP-3.
PROCEDURE DIVISION.
A00-BEGIN.
    DISPLAY "Enter data item (NUM-DATA) but SIZE = 3:"
        LINE 1 COLUMN 14
        UNDERLINED
        ERASE SCREEN.
    PERFORM ACCEPT-THREE 5 TIMES.
    DISPLAY "Same data item (NUM-DATA) BUT SIZE = 10:" LINE PLUS 3
        COLUMN 14
        UNDERLINED.
    PERFORM ACCEPT-TEN 5 TIMES.
    STOP RUN.

ACCEPT-THREE.
    ACCEPT NUM-DATA WITH CONVERSION PROTECTED SIZE 3
        LINE PLUS COLUMN 14.

ACCEPT-TEN.
    ACCEPT NUM-DATA WITH CONVERSION PROTECTED SIZE 10
        LINE PLUS COLUMN 14
        ON EXCEPTION
            DISPLAY "TOO MANY NUMBERS--try this one again!!!"
                COLUMN PLUS
                REVERSED
                GO TO ACCEPT-TEN.
    
```

Figure 11-8 Screen Display of NUM-DATA Using the PROTECTED Option

```

1234567890123456789012345678901234567890123456789012345678901234567890
1  Enter data item (NUM-DATA) but SIZE = 3:
2  1
3  999
4  1.1
5  .12
6  .99
7
8
9  Same data item (NUM-DATA) BUT SIZE = 10:
10 1234567890 TOO MANY NUMBERS--try this one again!!!
11 123456789
12 123456789.
13 1.23456789
14 .123456789
15 12345.6789
16
17
18
19
20
21
22
23
24
    
```

ZK-6109-GE



## Using ACCEPT and DISPLAY Statements for Input/Output and Video Forms

### 11.2 Designing Video Forms with ACCEPT and DISPLAY Statement Extensions

#### Example 11–8 Using the NO ECHO Phrase

```
IDENTIFICATION DIVISION.  
PROGRAM-ID. NOSHOW.  
ENVIRONMENT DIVISION.  
DATA DIVISION.  
WORKING-STORAGE SECTION.  
01 PASSWORD PIC X(25).  
PROCEDURE DIVISION.  
A00-BEGIN.  
    DISPLAY "ENTER YOUR PASSWORD: " LINE 5 COLUMN 10  
        ERASE SCREEN.  
    ACCEPT PASSWORD WITH NO ECHO.  
    STOP RUN.
```

#### 11.2.5.5 Assigning Default Values to Data Fields

Use the DEFAULT phrase to assign a value to an ACCEPT data item whenever:

- The program requires a value, and the operator does not have a value for the data item.
- There is a high probability that the default value is identical in most of the records, as where a constant (such as a state's abbreviation) is used in a mailing list.

When you use the DEFAULT phrase, the program executes as if the default value had been typed in when you press Return. However, the value is not automatically displayed on the screen.

You can also use the CURRENT VALUE phrase with the DEFAULT phrase to specify that the default input value is the initial value of the ACCEPT destination item.

Example 11–9 and Figure 11–9 show how to use the DEFAULT phrase to specify default input values. (The value must be an alphanumeric data name, a nonnumeric literal, or figurative constant.) The example uses the "TO-BE-SUPPLIED" abbreviations "[TBS]" and "\*\*\*[TBS]\*\*\*\*" and +00.00 as the default values for three data items in the program.

# Using ACCEPT and DISPLAY Statements for Input/Output and Video Forms

## 11.2 Designing Video Forms with ACCEPT and DISPLAY Statement Extensions

### Example 11-9 Using the DEFAULT Phrase

```
IDENTIFICATION DIVISION.
PROGRAM-ID. TRYDEF.
ENVIRONMENT DIVISION.
DATA DIVISION.
WORKING-STORAGE SECTION.
01 DATA1A      PIC 9(12).
01 NAME1A      PIC XXXXX.
01 PRICEA      PIC S99V99.
01 DATA123.
   02 NAME1B   PIC XXXXX.
   02         PIC XX VALUE SPACES.
   02 DATA1B  PIC XXXXXXXXXXXXX.
   02         PIC XXX VALUE SPACES.
   02 PRICEB   PIC $99.99-.
01 NAME-DEFAULT PIC XXXXX VALUE "[TBS]".
01 COL-NUM     PIC 99 VALUE 10.
PROCEDURE DIVISION.
A00-DEFAULT-TEST.
  DISPLAY "*****PLEASE ENTER THE FOLLOWING INFORMATION*****"
    LINE 5 COLUMN 15
    REVERSED BLINKING
    ERASE SCREEN.
  DISPLAY "*****"
    LINE 7 COLUMN 15.
  DISPLAY " Part      Part      -----STORED AS-----"
    LINE 9 COLUMN 15.
  DISPLAY " Name      Number    Price   Name      Number      Price"
    LINE 10 COLUMN 15.
  DISPLAY "Defaults --->[TBS] ***[TBS]**** +00.00"
    LINE 11 COLUMN 2.
  DISPLAY "-----"
    LINE 12 COLUMN 15.
  DISPLAY "*****"
    LINE 20 COLUMN 15.
  DISPLAY "5. " REVERSED BLINKING LINE 18 COLUMN COL-NUM.
  DISPLAY "4. " REVERSED BLINKING LINE 17 COLUMN COL-NUM.
  DISPLAY "3. " REVERSED BLINKING LINE 16 COLUMN COL-NUM.
  DISPLAY "2. " REVERSED BLINKING LINE 15 COLUMN COL-NUM.
  DISPLAY "1. " REVERSED BLINKING LINE 14 COLUMN COL-NUM.
  DISPLAY " " LINE 13 COLUMN 15.
  PERFORM A05-GET-DATA 5 TIMES.
  DISPLAY " " LINE 22 COLUMN 1.
  STOP RUN.
```

(continued on next page)

# Using ACCEPT and DISPLAY Statements for Input/Output and Video Forms

## 11.2 Designing Video Forms with ACCEPT and DISPLAY Statement Extensions

### Example 11-9 (Cont.) Using the DEFAULT Phrase

```
A05-GET-DATA.
ACCEPT NAME1A
    PROTECTED
    DEFAULT NAME-DEFAULT
    LINE PLUS COLUMN 15 ERASE TO END OF LINE.
ACCEPT DATA1A
    PROTECTED
    DEFAULT "***[TBS]****"
    COLUMN 21.
ACCEPT PRICEA
    PROTECTED
    WITH CONVERSION
    DEFAULT ZERO
    COLUMN 34.
MOVE NAME1A TO NAME1B.
MOVE DATA1A TO DATA1B.
MOVE PRICEA TO PRICEB.
DISPLAY DATA123 REVERSED COLUMN 44.
```

Figure 11-9 Accepting Data with the DEFAULT Phrase

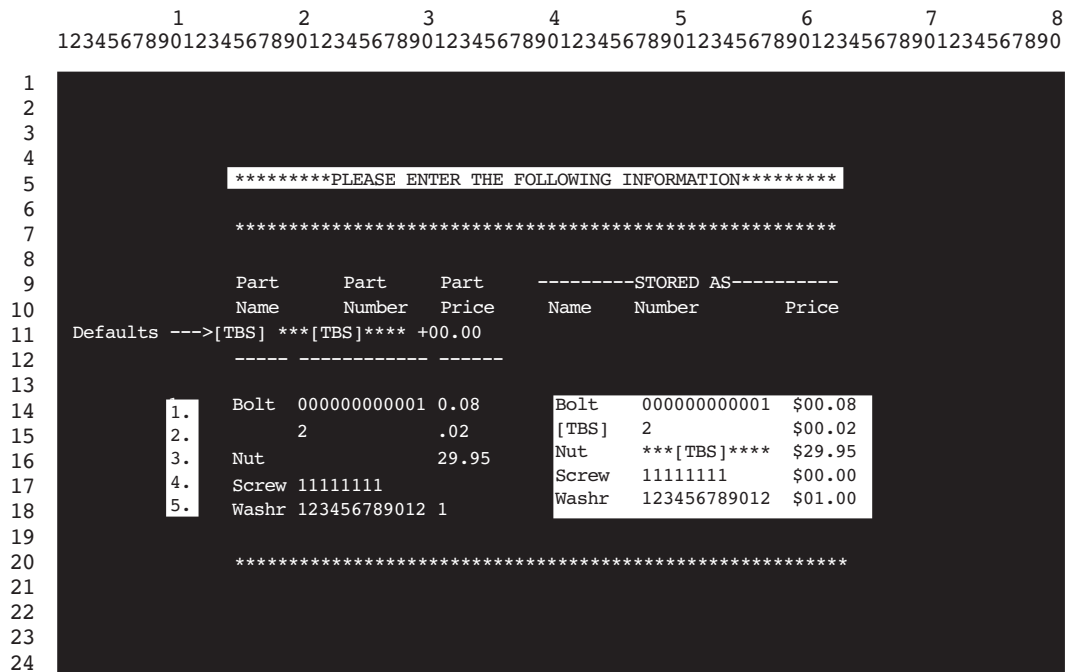

ZK-6097-GE

## Using ACCEPT and DISPLAY Statements for Input/Output and Video Forms

### 11.2 Designing Video Forms with ACCEPT and DISPLAY Statement Extensions

#### 11.2.6 Using Terminal Keys to Define Special Program Functions

Use the CONTROL KEY IN phrase of the ACCEPT statement to tailor your screen-handling programs to give special meanings to any or all of these keys on your terminal:

- Cursor positioning keys (up arrow, down arrow, left arrow, and right arrow keys)
- Program function keys (PF1, PF2, PF3, and PF4)
- Function keys (F6 to F20)
- Keypad keys (if in application keypad mode) 0 to 9, minus (-), comma (,), period (.), ENTER, FIND, INSERT HERE, REMOVE, SELECT, PREV SCREEN, NEXT SCREEN

You can use the CONTROL KEY IN phrase to accept data and to terminate it with a control key or to allow a user to press only a control key (for menu applications).

Table 11–2 lists the characters returned to the data name specified in the CONTROL KEY IN phrase.

Table 11–2 is for VT100 and later series terminals. Depending on your terminal type, certain keys listed in this table are not applicable to your terminal keyboard.

**Table 11–2 HP COBOL Characters Returned for Cursor Positioning, Program Function, Function, Keypad, and Keyboard Keys**

Key Name	Keypad or Keyboard Name	Characters Returned in the Data Name Specified by CONTROL KEY IN	
		First <sup>1</sup>	Remaining (Notes)
Cursor up	up arrow	CSI	A
Cursor down	down arrow	CSI	B
Cursor right	right arrow	CSI	C
Cursor left	left arrow	CSI	D
Program function	PF1	SS3	P
Program function	PF2	SS3	Q
Program function	PF3	SS3	R
Program function	PF4	SS3	S
Keypad	left blank	SS3	P
Keypad	center blank	SS3	Q
Keypad	right blank	SS3	R
Keypad	0	SS3	p
Keypad	1	SS3	q
Keypad	2	SS3	r
Keypad	3	SS3	s

<sup>1</sup>The CSI and SS3 characters are shown for your information only. You need not check for their presence because the remaining characters are unique and need no qualification.

(continued on next page)

## Using ACCEPT and DISPLAY Statements for Input/Output and Video Forms

### 11.2 Designing Video Forms with ACCEPT and DISPLAY Statement Extensions

**Table 11–2 (Cont.) HP COBOL Characters Returned for Cursor Positioning, Program Function, Function, Keypad, and Keyboard Keys**

Key Name	Keypad or Keyboard Name	Characters Returned in the Data Name Specified by CONTROL KEY IN	
		First <sup>1</sup>	Remaining (Notes)
Keypad	4	SS3	t
Keypad	5	SS3	u
Keypad	6	SS3	v
Keypad	7	SS3	w
Keypad	8	SS3	x
Keypad	9	SS3	y
Keypad	-	SS3	m
Keypad	,	SS3	l
Keypad	.	SS3	n
Keypad	ENTER	SS3	M
Keypad	FIND	CSI	1~
Keypad	INSERT HERE	CSI	2~
Keypad	REMOVE	CSI	3~
Keypad	SELECT	CSI	4~
Keypad	PREV SCREEN	CSI	5~
Keypad	NEXT SCREEN	CSI	6~
Tab	Tab	9	
Return	Return	13	
Function key	HOLD SCREEN	Not Available	
Function key	PRINT SCREEN	Not Available	
Function key	SET-UP	Not Available	
Function key	DATA/TALK	Not Available	
Function key	BREAK	Not Available	
Function key	F6 <sup>2</sup>	CSI	17~
Function key	F7	CSI	18~
Function key	F8	CSI	19~
Function key	F9	CSI	20~
Function key	F10	CSI	21~
Function key	F11 (ESC)	CSI	23~
Function key	F12 (BS)	CSI	24~
Function key	F13 (LF)	CSI	25~
Function key	F14	CSI	26~
Function key	F15 (HELP)	CSI	28~

<sup>1</sup>The CSI and SS3 characters are shown for your information only. You need not check for their presence because the remaining characters are unique and need no qualification.

<sup>2</sup>For F6, you must have specified \$ SET TERMINAL/NOLINE\_EDITING before running your program.

(continued on next page)

## Using ACCEPT and DISPLAY Statements for Input/Output and Video Forms

### 11.2 Designing Video Forms with ACCEPT and DISPLAY Statement Extensions

**Table 11–2 (Cont.) HP COBOL Characters Returned for Cursor Positioning, Program Function, Function, Keypad, and Keyboard Keys**

Key Name	Keypad or Keyboard Name	Characters Returned in the Data Name Specified by CONTROL KEY IN	
		First <sup>1</sup>	Remaining (Notes)
Function key	F16 (DO)	CSI	29~
Function key	F17	CSI	31~
Function key	F18	CSI	32~
Function key	F19	CSI	33~
Function key	F20	CSI	34~
Ctrl/A		1	
Ctrl/B		2	
Ctrl/C		Not Available	
Ctrl/D		4	(on Alpha, I64)
Ctrl/D		Results depend on presence or absence of the AT END phrase in the ACCEPT statement	(on Tru64 UNIX)
Ctrl/E		5	
Ctrl/F		6	
Ctrl/G		7	
Ctrl/H		8	
Ctrl/I (Tab)		9	
Ctrl/J		10	
Ctrl/K		11	
Ctrl/L		12	
Ctrl/M (Return)		13	
Ctrl/N		14	
Ctrl/O		Not Available	(on Alpha, I64)
Ctrl/O		15	(on Tru64 UNIX)
Ctrl/P		16	
Ctrl/Q		Not Available	
Ctrl/R		18	
Ctrl/S		Not Available	
Ctrl/T		Depends on SET CONTROL Setting	(on Alpha, I64)
Ctrl/T		20	(on Tru64 UNIX)
Ctrl/U		21	

<sup>1</sup>The CSI and SS3 characters are shown for your information only. You need not check for their presence because the remaining characters are unique and need no qualification.

(continued on next page)

# Using ACCEPT and DISPLAY Statements for Input/Output and Video Forms

## 11.2 Designing Video Forms with ACCEPT and DISPLAY Statement Extensions

**Table 11–2 (Cont.) HP COBOL Characters Returned for Cursor Positioning, Program Function, Function, Keypad, and Keyboard Keys**

Key Name	Keypad or Keyboard Name	Characters Returned in the Data Name Specified by CONTROL KEY IN	
		First <sup>1</sup>	Remaining (Notes)
Ctrl/V		22	
Ctrl/W		23	
Ctrl/X		24	
Ctrl/Y		Not Available	(on Alpha, I64)
Ctrl/Y		25	(on Tru64 UNIX)
Ctrl/Z		Results depend on presence or absence of the AT END phrase in the ACCEPT statement	(on Alpha, I64)
Ctrl/Z		Not Available	(on Tru64 UNIX)

<sup>1</sup>The CSI and SS3 characters are shown for your information only. You need not check for their presence because the remaining characters are unique and need no qualification.

The definition and value of the CSI and SS3 characters used in Table 11–2 follow:

```

01 SS3X          PIC 9999 COMP VALUE 143.
01 SS3 REDEFINES SS3X PIC X.
01 CSIX         PIC 9999 COMP VALUE 155.
01 CSI REDEFINES CSIX PIC X.
    
```

Figure 11–10 and Figure 11–11 show the HP COBOL control keys for various terminals. The shaded keys correspond to the keypad names in Table 11–2, which lists the characters returned to the application program.

**Note**

In Figure 11–11, your keyboard may differ slightly, but the HP COBOL control keys are as pictured.

**Figure 11–10 HP COBOL Control Keys on the Standard VT100 Keypad and Keyboard**

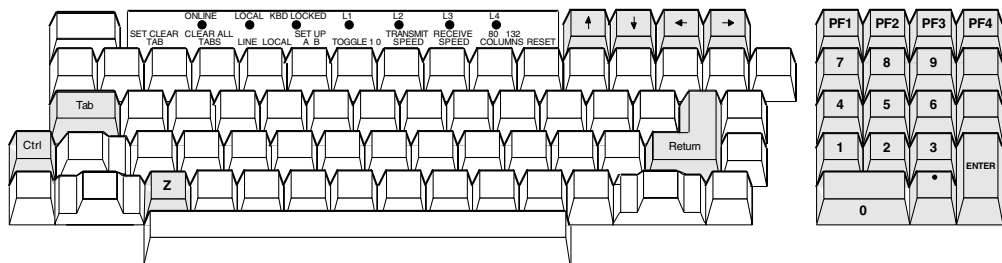

ZK-6099-GE

# Using ACCEPT and DISPLAY Statements for Input/Output and Video Forms

## 11.2 Designing Video Forms with ACCEPT and DISPLAY Statement Extensions

Figure 11–11 HP COBOL Control Keys on a Typical VT200 or Later Keypad and Keyboard

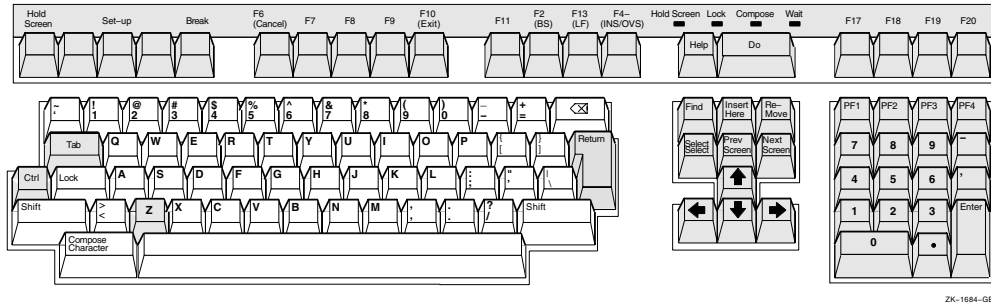

Example 11–10 shows you how to use the CONTROL KEY phrase to handle arrow keys, program function keys, keypad keys, Ctrl/Z, Tab, and Return.

When you use this phrase, you allow program function keys and arrow keys, as well as Return and Tab keys, to terminate input. This phrase also permits you to use those keys to move the cursor and to make menu selections without typing any data on the screen.

---

### Note

---

To activate the auxiliary keypad, your program must execute DISPLAY ESC “=”. You must also define ESC as the escape character. Refer to Example 11–10.

---

In Example 11–10, the terminator key codes are displayed on the screen.



## Using ACCEPT and DISPLAY Statements for Input/Output and Video Forms

### 11.2 Designing Video Forms with ACCEPT and DISPLAY Statement Extensions

#### Example 11-10 Using the CONTROL KEY IN Phrase

```
IDENTIFICATION DIVISION.
PROGRAM-ID. SPECIAL.
ENVIRONMENT DIVISION.
CONFIGURATION SECTION.
SPECIAL-NAMES.
    SYMBOLIC CHARACTERS
        CR-VAL  CSI-VAL  Ctrl-Z-VAL  SS3-VAL  TAB-VAL  ESC
        ARE 14      156      27          144      10       28.
DATA DIVISION.
WORKING-STORAGE SECTION.
*
*       The code returned will be the same regardless of
*       terminal type.
*
01 CONTROL-KEY.
    02 FIRST-CHAR-CONTROL-KEY PIC X.
        88 CR                VALUE CR-VAL.
        88 CSI                VALUE CSI-VAL.
        88 Ctrl-Z            VALUE Ctrl-Z-VAL.
        88 SS3                VALUE SS3-VAL.
        88 TAB                VALUE TAB-VAL.
    02 REMAINING-CHAR-CONTROL-KEY PIC XXXX.
        88 UP-ARROW          VALUE "A".
        88 DOWN-ARROW        VALUE "B".
        88 RIGHT-ARROW       VALUE "C".
        88 LEFT-ARROW        VALUE "D".
        88 PF1                VALUE "P".
        88 PF2                VALUE "Q".
        88 PF3                VALUE "R".
        88 PF4                VALUE "S".
        88 AUX0                VALUE "p".
        88 AUX1                VALUE "q".
        88 AUX2                VALUE "r".
        88 AUX3                VALUE "s".
        88 AUX4                VALUE "t".
        88 AUX5                VALUE "u".
        88 AUX6                VALUE "v".
        88 AUX7                VALUE "w".
        88 AUX8                VALUE "x".
        88 AUX9                VALUE "y".
        88 AUXMINUS           VALUE "m".
        88 AUXCOMMA           VALUE "l".
        88 AUXPERIOD           VALUE "n".
        88 AUXENTER           VALUE "M".

PROCEDURE DIVISION.
P0.
*
* DISPLAY ESC "=" puts you in alternate keypad mode
*
    DISPLAY ESC "=".
    DISPLAY " " ERASE SCREEN.
P1.
    DISPLAY "Press a directional arrow, PF, Return, Tab, "
        LINE 3 COLUMN 4.
    DISPLAY "or auxiliary keypad key (Ctrl/Z stops loop)"
        LINE 4 COLUMN 4.
    ACCEPT CONTROL KEY IN CONTROL-KEY AT END GO TO P2.
```

(continued on next page)

## Using ACCEPT and DISPLAY Statements for Input/Output and Video Forms

### 11.2 Designing Video Forms with ACCEPT and DISPLAY Statement Extensions

#### Example 11–10 (Cont.) Using the CONTROL KEY IN Phrase

```
IF CR DISPLAY "RETURN" LINE 10 COLUMN 5 ERASE LINE GO TO P1.
IF TAB DISPLAY "\TAB" LINE 10 COLUMN 5 ERASE LINE GO TO P1.
IF PF1 DISPLAY "PF1" LINE 10 COLUMN 5 ERASE LINE GO TO P1.
IF PF2 DISPLAY "PF2" LINE 10 COLUMN 5 ERASE LINE GO TO P1.
IF PF3 DISPLAY "PF3" LINE 10 COLUMN 5 ERASE LINE GO TO P1.
IF PF4 DISPLAY "PF4" LINE 10 COLUMN 5 ERASE LINE GO TO P1.
IF UP-ARROW DISPLAY "UP-ARROW" LINE 10 COLUMN 5 ERASE LINE
GO TO P1.
IF DOWN-ARROW DISPLAY "DOWN-ARROW" LINE 10 COLUMN 5
ERASE LINE GO TO P1.
IF LEFT-ARROW DISPLAY "LEFT-ARROW" LINE 10 COLUMN 5
ERASE LINE GO TO P1.
IF RIGHT-ARROW DISPLAY "RIGHT-ARROW" LINE 10 COLUMN 5
ERASE LINE GO TO P1.
IF AUX0 DISPLAY "AUXILIARY KEYPAD 0" LINE 10 COLUMN 5
ERASE LINE GO TO P1.
IF AUX1 DISPLAY "AUXILIARY KEYPAD 1" LINE 10 COLUMN 5
ERASE LINE GO TO P1.
IF AUX2 DISPLAY "AUXILIARY KEYPAD 2" LINE 10 COLUMN 5
ERASE LINE GO TO P1.
IF AUX3 DISPLAY "AUXILIARY KEYPAD 3" LINE 10 COLUMN 5
ERASE LINE GO TO P1.
IF AUX4 DISPLAY "AUXILIARY KEYPAD 4" LINE 10 COLUMN 5
ERASE LINE GO TO P1.
IF AUX5 DISPLAY "AUXILIARY KEYPAD 5" LINE 10 COLUMN 5
ERASE LINE GO TO P1.
IF AUX6 DISPLAY "AUXILIARY KEYPAD 6" LINE 10 COLUMN 5
ERASE LINE GO TO P1.
IF AUX7 DISPLAY "AUXILIARY KEYPAD 7" LINE 10 COLUMN 5
ERASE LINE GO TO P1.
IF AUX8 DISPLAY "AUXILIARY KEYPAD 8" LINE 10 COLUMN 5
ERASE LINE GO TO P1.
IF AUX9 DISPLAY "AUXILIARY KEYPAD 9" LINE 10 COLUMN 5
ERASE LINE GO TO P1.
IF AUXMINUS DISPLAY "AUXILIARY KEYPAD -" LINE 10 COLUMN 5
ERASE LINE GO TO P1.
IF AUXCOMMA DISPLAY "AUXILIARY KEYPAD ," LINE 10 COLUMN 5
ERASE LINE GO TO P1.
IF AUXPERIOD DISPLAY "AUXILIARY KEYPAD ." LINE 10 COLUMN 5
ERASE LINE GO TO P1.
IF AUXENTER DISPLAY "AUXILIARY KEYPAD ENTER" LINE 10 COLUMN 5
ERASE LINE GO TO P1.
```

(continued on next page)

## Using ACCEPT and DISPLAY Statements for Input/Output and Video Forms

### 11.2 Designing Video Forms with ACCEPT and DISPLAY Statement Extensions

#### Example 11–10 (Cont.) Using the CONTROL KEY IN Phrase

```
DISPLAY "Not an allowable control key -"  
        "press the Return key to continue"  
  
        LINE 10 COLUMN 5  
        WITH BELL ERASE LINE.  
ACCEPT CONTROL-KEY.  
GO TO P1.  
P2.  
DISPLAY "Press the Return key to end this job"  
        LINE 11 COLUMN 5 ERASE LINE.  
ACCEPT CONTROL KEY IN CONTROL-KEY LINE 12 COLUMN 5 ERASE LINE.  
IF NOT CR GO TO P0  
ELSE  
    DISPLAY "END OF JOB" LINE 13 COLUMN 35  
        BOLD BLINKING REVERSED BELL  
        ERASE SCREEN.  
P3.  
* DISPLAY ESC ">" WITH NO puts you out of alternate keypad mode  
*  
    DISPLAY ESC ">" WITH NO.  
STOP RUN.
```

Figure 11–12 shows a sample run of the program in Example 11–10 using the right arrow terminal key.

To expand upon Example 11–10, you can, for example, accept data in addition to specifying the CONTROL KEY phrase. This enables you to accept data and determine what to do next based on the data. You can use the CONTROL KEY phrase to move the cursor around on the screen or take a specific course of action.

# Using ACCEPT and DISPLAY Statements for Input/Output and Video Forms

## 11.2 Designing Video Forms with ACCEPT and DISPLAY Statement Extensions

Figure 11–12 Screen Display of Program SPECIAL

```

1      1      2      3      4      5      6      7      8
123456789012345678901234567890123456789012345678901234567890
1
2
3      Press a directional arrow, PF, RETURN, TAB,
4      or auxiliary keypad key (CTRL/Z stops loop)
5
6
7
8
9
10     RIGHT-ARROW
11
12
13
14
15
16
17
18
19
20
21
22
23
24

```

ZK-6100-GE

### 11.2.7 Using the EDITING Phrase

Specifying the EDITING phrase of the ACCEPT statement enables field editing. Table 11–3 briefly describes the keys that the EDITING phrase enables. Refer to the ACCEPT section of the *HP COBOL Reference Manual* for a complete list of field editing keys.

Table 11–3 Key Functions for the EDITING Phrase

Key	Function	Description
Left arrow	Move-left	Moves the cursor one space to the left. If the cursor is at the first character position of the field, the terminal bell rings.
Right arrow	Move-right	Moves the cursor one space to the right. If the cursor is one space beyond the rightmost character position of the field, the terminal bell rings.
F12 (BS)	Beginning-of-field	Positions the cursor to the first character position of the field.
Ctrl/E	End-of-field	Moves the cursor one position beyond the rightmost character position in the field.
Ctrl/U	Erase-field	Erases the entire field and moves the cursor to the first character position of the field.
F14	Switch-mode	Switches the editing mode between insert and overstrike.

Example 11–11 shows the sample code that produces the form in Figure 11–13. (The Current Value field is provided for example purposes only.)

## Using ACCEPT and DISPLAY Statements for Input/Output and Video Forms

### 11.2 Designing Video Forms with ACCEPT and DISPLAY Statement Extensions

#### Example 11-11 EDITING Phrase Sample Code

```
.
.
.
PROCEDURE DIVISION.
A1000-BEGIN.
    OPEN I-O EMP-FILE.
.
.
.
B1000-MODIFY.
    DISPLAY "MODIFY EMPLOYEE INFORMATION FORM" ERASE SCREEN
                                     AT LINE 2      COLUMN 8.
    DISPLAY "Enter Employee Number : " AT LINE PLUS 2 COLUMN 8.

    ACCEPT EMP-KEY
        FROM LINE 4 COLUMN 32
        PROTECTED WITH EDITING REVERSED
        DEFAULT IS CURRENT
        AT END
        STOP RUN.
.
.
.
B2000-DISPLAY.
    MOVE EMP-REC TO OUT-REC.

    DISPLAY "Date of Hire : "          AT LINE PLUS 2 COLUMN 8.
    DISPLAY MON-IN                     AT          COLUMN 24.
    DISPLAY "-"                         AT          COLUMN 26.
    DISPLAY DAY-IN                      AT          COLUMN 27.
    DISPLAY "-"                         AT          COLUMN 29.
    DISPLAY YR-IN                       AT          COLUMN 30.
    DISPLAY "Current Value :"          AT COLUMN 38.
    DISPLAY MON-NUM                     AT          COLUMN 54.
    DISPLAY "-"                         AT          COLUMN 56.
    DISPLAY DAY-NUM                     AT          COLUMN 57.
    DISPLAY "-"                         AT          COLUMN 59.
    DISPLAY YR-NUM                      AT          COLUMN 60.

    DISPLAY "Department :"             AT LINE PLUS 2 COLUMN 8.
    DISPLAY DEPT-IN                    AT          COLUMN 21.
    DISPLAY "Current Value :" AT COLUMN 38.
    DISPLAY DEPT-NUM                   AT          COLUMN PLUS.

    DISPLAY "First Name :"             AT LINE PLUS 2 COLUMN 8.
    DISPLAY F-NAME-IN                  AT          COLUMN 21.
    DISPLAY "Current Value :" AT          COLUMN 38.
    DISPLAY F-NAME                      AT          COLUMN PLUS.

    DISPLAY "Last Name :"              AT LINE PLUS 2 COLUMN 8.
    DISPLAY L-NAME-IN                  AT          COLUMN 20.
    DISPLAY "Current Value :" AT          COLUMN 38.
    DISPLAY L-NAME                      AT          COLUMN PLUS.

    ACCEPT MON-NUM
        FROM LINE 6 COLUMN 24
        PROTECTED WITH EDITING REVERSED
        DEFAULT IS CURRENT
        AT END
        STOP RUN.

    DISPLAY MON-NUM                    AT LINE 6      COLUMN 54.
```

(continued on next page)

## Using ACCEPT and DISPLAY Statements for Input/Output and Video Forms

### 11.2 Designing Video Forms with ACCEPT and DISPLAY Statement Extensions

#### Example 11–11 (Cont.) EDITING Phrase Sample Code

```
ACCEPT DAY-NUM
  FROM LINE 6 COLUMN 27
  PROTECTED WITH EDITING REVERSED
  DEFAULT IS CURRENT
  AT END
  STOP RUN.

DISPLAY DAY-NUM                      AT LINE 6      COLUMN 57.

ACCEPT YR-NUM
  FROM LINE 6 COLUMN 30
  PROTECTED WITH EDITING REVERSED
  DEFAULT IS CURRENT
  AT END
  STOP RUN.

DISPLAY YR-NUM                      AT LINE 6      COLUMN 60.

ACCEPT DEPT-NUM
  FROM LINE 8 COLUMN 21
  PROTECTED WITH EDITING REVERSED
  DEFAULT IS CURRENT
  AT END
  STOP RUN.

DISPLAY DEPT-NUM                    AT LINE 8      COLUMN 54.

ACCEPT F-NAME
  FROM LINE 10 COLUMN 21
  PROTECTED WITH EDITING REVERSED
  DEFAULT IS CURRENT
  AT END
  STOP RUN.

DISPLAY F-NAME                      AT LINE 10     COLUMN 54.

ACCEPT L-NAME
  FROM LINE 12 COLUMN 20
  PROTECTED WITH EDITING REVERSED
  DEFAULT IS CURRENT
  AT END
  STOP RUN.

DISPLAY L-NAME                      AT LINE 12     COLUMN 54.
.
.
.
```

Because the ACCEPT statements in Example 11–11 contain EDITING phrases, a person using the form in Figure 11–13 can use any of the keys listed in Table 11–3 for field editing purposes to make corrections or modifications.

## Using ACCEPT and DISPLAY Statements for Input/Output and Video Forms

### 11.3 Designing Video Forms with Screen Section ACCEPT and DISPLAY (Alpha, I64)

Figure 11–13 Form with ACCEPT WITH EDITING Phrase

```
1 2 3 4 5 6 7 8
123456789012345678901234567890123456789012345678901234567890
1
2   MODIFY EMPLOYEE INFORMATION FORM
3
4   Enter Employee Number : 1221   Current Value : 1221
5
6   Date of Hire : 11-22-88       Current Value : 11-22-88
7
8   Department : UB40             Current Value : UB40
9
10  First Name : HENRY            Current Value : HENRY
11
12  Last Name : JAMES             Current Value : JAMES
13
14
15
16
17
18
19
20
21
22
23
24
```

ZK-1516A-GE

### 11.3 Designing Video Forms with Screen Section ACCEPT and DISPLAY (Alpha, I64)

The Screen Section feature provides an efficient alternative to the ACCEPT and DISPLAY extensions for designing video forms. Screen Section, which is based on the X/Open CAE Specification for COBOL, is also a Hewlett-Packard extension to the ANSI Standard. It enables you to design video forms in a single section of your HP COBOL program. Then, in the Procedure Division, you can accept or display an entire screen of data with a single ACCEPT or DISPLAY statement, instead of multiple statements.

You can design your form as follows:

1. In the SPECIAL-NAMES paragraph in the Environment Division, you can optionally do the following:
  - Specify the cursor position with the CURSOR IS option.
  - Set up an indicator to discover the cause of termination of an ACCEPT statement, with the CRT STATUS IS option.

For example:

```
SPECIAL-NAMES.
    CURSOR IS CURSOR-POSITION
    CRT STATUS IS CRT-STATUS.
```

2. You can use the Screen Section in the Data Division to define a screen description entry to describe each input and output item within the video form. Do this for each screen in your application.

# Using ACCEPT and DISPLAY Statements for Input/Output and Video Forms

## 11.3 Designing Video Forms with Screen Section ACCEPT and DISPLAY (Alpha, I64)

For example:

```
SCREEN SECTION.
01 MENU-SCREEN BLANK SCREEN FOREGROUND-COLOR 7 BACKGROUND-COLOR 1.
02 MENU-SCREEN-2.
03 TITLE-BAR
   FOREGROUND-COLOR 7 BACKGROUND-COLOR 4.
04 LINE 1 PIC X(80) FROM EMPTY-LINE.
04 LINE 1 COLUMN 32 VALUE "Daily Calendar".
```

See Section 11.3.1 for a description of the options available in the Screen Section.

- Then you use the ACCEPT and DISPLAY statements in the Procedure Division with the screen description entries described in the Screen Section to accept or display each entire screen or part of the screen. During a DISPLAY, all output and update screen items are displayed. During an ACCEPT, all input and update screen items are accepted.

For example:

```
DISPLAY MENU-SCREEN.
.
.
.
ACCEPT MENU-SCREEN.
```

### 11.3.1 Using Screen Section Options (Alpha, I64)

You design your screens with screen description entries in the Screen Section of the Data Division of your program. Three formats are available for a screen description entry (and are completely defined in the Data Division chapter of the *HP COBOL Reference Manual*):

- Format 1 — A group screen item
- Format 2 — An elementary output screen item with a literal value; it includes the VALUE clause
- Format 3 — An elementary output, input, or update screen item; it includes the PICTURE clause

Table 11–4 shows the optional clauses you can use in a screen description entry to specify character attributes, the formats to which they apply, and a summary of their functions. (They are completely described in the Data Division chapter of the *HP COBOL Reference Manual*.)

**Table 11–4 Character Attribute Clauses for Screen Description Formats (Alpha, I64)**

Clause	Formats	Function
AUTO	1,3	Moves the cursor to the next field when the last character of a field is entered.
BACKGROUND-COLOR	1, 2, 3	Specifies by number (in the range 0–7) the screen item's background color (see the color list that follows).
BELL	2, 3	Sounds the audio tone on the workstation or terminal.
BLANK LINE	2, 3	Clears the line before displaying the screen item.

(continued on next page)



## Using ACCEPT and DISPLAY Statements for Input/Output and Video Forms

### 11.3 Designing Video Forms with Screen Section ACCEPT and DISPLAY (Alpha, I64)

**Table 11–4 (Cont.) Character Attribute Clauses for Screen Description Formats (Alpha, I64)**

Clause	Formats	Function
BLANK SCREEN	1, 2, 3	Clears the screen before displaying the screen item.
BLANK WHEN ZERO[ES]	3	Replaces zeros with spaces when a screen item's value is zero.
BLINK	2, 3	Causes the displayed item to blink.
COLUMN NUMBER	2, 3	Specifies the horizontal position of an item on the screen.
ERASE EOL	2, 3	Clears the line from the cursor position to the end.
ERASE EOS	2, 3	Clears the screen from the cursor position to the end.
FOREGROUND-COLOR	1, 2, 3	Specifies by number (in range 0–7) the screen item's foreground color. See the color list that follows.
FULL	1, 3	Specifies that a screen item must either be left completely empty or be entirely filled with data.
HIGHLIGHT	2, 3	Specifies that the field is to appear on the screen with the highest intensity.
JUSTIFIED RIGHT	3	Specifies nonstandard data positioning. This can cause truncation of the leftmost characters if the sending item is too large. Otherwise, this aligns the data at the rightmost character position.
LINE NUMBER	2, 3	Specifies the vertical position of an item on the screen.
LOWLIGHT	2, 3	Specifies that the field is to appear on the screen with the lowest intensity. If only two levels of intensity are available, LOWLIGHT is the same as normal.
REQUIRED	1, 3	Specifies that at least one character must be entered in the input or update field.
REVERSE-VIDEO	2, 3	Specifies that the foreground and background colors be exchanged.
SECURE	1, 3	Specifies that no characters are displayed when the input field is entered.
SIGN LEADING [SEPARATE]	1, 3	Specifies the existence of a sign character as the leading character in the field. The SEPARATE option is always in effect if the screen item has an 'S' in the PICTURE clause. Therefore, for a screen item, the sign character never shares its position with a digit.
SIGN TRAILING [SEPARATE]	1, 3	Specifies the existence of a sign character as the trailing character in the field. The SEPARATE option is always in effect if the screen item has an 'S' in the PICTURE clause. Therefore, for a screen item, the sign character never shares its position with a digit.
UNDERLINE	2, 3	Specifies that each character of the field is to be underlined when displayed.
USAGE DISPLAY	1, 3	Specifies the internal format of a data item as DISPLAY (the default).

When you specify the foreground and background colors for a screen item, you use numbers in the range 0–7, which represent specific colors as described in

# Using ACCEPT and DISPLAY Statements for Input/Output and Video Forms

## 11.3 Designing Video Forms with Screen Section ACCEPT and DISPLAY (Alpha, I64)

Table 11–5. Note that these colors are supported only on terminals that support ANSI Standard color sequences.<sup>1</sup>

**Table 11–5 Color Table**

Color	Color Value	Color	Color Value
Black	0	Red	4
Blue	1	Magenta	5
Green	2	Yellow/Brown	6
Cyan	3	White	7

### 11.3.1.1 Comparison of Screen Section Extensions (Alpha, I64) with Other Extensions of ACCEPT and DISPLAY

This section points out some of the major differences and similarities between the Screen Section and non-Screen Section extensions to help you determine which to use.

#### Similarities

There are significant similarities between the Screen Section feature and that of the non-Screen Section screen formats, as follows:

- You can clear part or all of your screen as you DISPLAY a screen. Each output screen item within a screen description entry can specify an ERASE option.
- With all formats, if you do not specify the initial cursor position, by default it will be at the upper left corner of the screen — screen coordinates (1,1), first line, first column.
- Each screen item within a screen description entry can specify a line and column position. If the line and column are not specified for a screen item, then the screen item begins immediately following the previous screen item. Regardless of whether you display or accept the entire screen or only part of the screen, the positioning of each screen item remains the same.
- If you display escape or control sequences within a screen description entry, you need to use absolute cursor positioning to get predictable results.

In a number of cases, a clause that you can use in the Screen Section of the Data Division, in the screen description entry, accomplishes the same purpose as a clause in the Procedure Division's ACCEPT or DISPLAY statement (in a non-Screen Section extended format). The difference is in the clauses' names (not interchangeable) and where you use them: in the Data Division's Screen Section, or in the Procedure Division with the ACCEPT or DISPLAY statement. The following table shows these clauses:

Screen Section Clause	ACCEPT or DISPLAY Clause with Equivalent Effect
AUTO	AUTOTERMINATE
BLANK LINE	ERASE LINE

<sup>1</sup> This does *not* include the VT100, VT200, VT300, VT400, and VT500 series terminals. On workstations that emulate these terminal types, this restriction may not apply.

## Using ACCEPT and DISPLAY Statements for Input/Output and Video Forms

### 11.3 Designing Video Forms with Screen Section ACCEPT and DISPLAY (Alpha, I64)

Screen Section Clause	ACCEPT or DISPLAY Clause with Equivalent Effect
BLANK SCREEN	ERASE SCREEN
BLINK	WITH BLINKING
ERASE EOL	ERASE TO END OF LINE
ERASE EOS	ERASE TO END OF SCREEN
HIGHLIGHT	BOLD
REVERSE-VIDEO	REVERSED
SECURE	WITH NO ECHO
UNDERLINE	UNDERLINED

#### Differences

There are also significant differences between the Screen Section (Alpha, I64) and the non-Screen Section screen formats. With the Screen Section:

- You can define screen items that wrap onto multiple lines. The editing of these fields during an ACCEPT operation differs from that of the other extended formats of ACCEPT.
- The use of editing keys during an ACCEPT is always allowed.
- The size of each field (for an elementary screen item) is defined by the PICTURE or VALUE clause.
- Conversion is always performed during an ACCEPT; as the operator leaves each field, HP COBOL performs field validation and conversion and displays the resulting value.
- The screen does not scroll during a Screen Section ACCEPT or DISPLAY. Any fields that are positioned beyond the edge of the screen are truncated.
- In addition to the line and column position for each screen item, you can also specify a line and column position for the ACCEPT and DISPLAY statements. By default, this position is at (1,1), so your screen item positions are offset from the upper left corner of the screen. However, if you specify new starting screen coordinates with the LINE and COLUMN options of the ACCEPT or DISPLAY statement, you thereby resize the screen. Then any LINE and COLUMN options specified in the screen description entry are positioned for the *resized* screen coordinates.

For example, if you picture the usual terminal screen as follows:



the LINE and COLUMN values specified in the ACCEPT or DISPLAY statement might resize the screen as shown in the following interior box:

## Using ACCEPT and DISPLAY Statements for Input/Output and Video Forms

### 11.3 Designing Video Forms with Screen Section ACCEPT and DISPLAY (Alpha, I64)

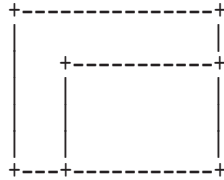

It can be useful to specify LINE and COLUMN in both your screen description entry and in your ACCEPT or DISPLAY statement. For example, in your screen description entry, you could create a legend box, and then specify with the DISPLAY statement's LINE and COLUMN options the starting screen coordinates of (1,60) to display the legend in the upper right corner of the screen (starting in the 60th column of the first line). Elsewhere, you could display the legend box, using the same screen description entry, at a different position on the screen, by choosing different LINE and COLUMN options with the DISPLAY statement.

- The default value for an update screen item is the current value of the FROM or USING data item. The default value for an input screen item is spaces or zero, depending on the data type of the screen item.  
If the operator terminates the ACCEPT before entering a value for each field, the default value remains in the untouched screen items.
- To catch any function keys that the operator presses, use the CRT STATUS option. All control sequences are captured and processed by HP COBOL and not returned to the application.

Refer to Section 11.2, and also the *HP COBOL Reference Manual* Data Division chapter's section on Screen Description and clauses, for details on these features.

In Example 11–12 (Alpha and I64 only), a video form is designed for a daily calendar. With it you can display appointments, schedule new appointments, cancel appointments, and print appointments.

#### Example 11–12 Designing a Video Form for a Daily Calendar (Alpha, I64)

```
IDENTIFICATION DIVISION.  
PROGRAM-ID. MENU.
```

```
ENVIRONMENT DIVISION.  
CONFIGURATION SECTION.
```

- \* The SPECIAL-NAMES paragraph that follows provides for the
- \* capturing of the F10 function key and for positioning of the
- \* cursor.

```
SPECIAL-NAMES.
```

```
    SYMBOLIC CHARACTERS
```

```
        FKEY-10-VAL
```

```
    ARE 11
```

```
    CURSOR IS CURSOR-POSITION
```

```
    CRT STATUS IS CRT-STATUS.
```

(continued on next page)

## Using ACCEPT and DISPLAY Statements for Input/Output and Video Forms

### 11.3 Designing Video Forms with Screen Section ACCEPT and DISPLAY (Alpha, I64)

#### Example 11-12 (Cont.) Designing a Video Form for a Daily Calendar (Alpha, I64)

```
DATA DIVISION.
WORKING-STORAGE SECTION.

*   CURSOR-LINE specifies the line and CURSOR-COL specifies the
*   column of the cursor position.

01 CURSOR-POSITION.
   02 CURSOR-LINE    PIC 99.
   02 CURSOR-COL    PIC 99.

*   Normal termination of the ACCEPT statement will result in a value
*   of '0' in KEY1.  When the user presses F10, the value in KEY1 will
*   be '1' and FKEY-10 will be true.

01 CRT-STATUS.
   03 KEY1           PIC X.
   03 KEY2           PIC X.
   88 FKEY-10       VALUE FKEY-10-VAL.
   03 filler        PIC X.

*   The following data items are for a "Daily Calendar."  It shows
*   the day's appointments and allows appointments to be made,
*   canceled, and printed.

01 ACCEPT-ITEM1    PIC X.
01 APPT-NAME       PIC X(160).
01 APPT-DAY        PIC XX.
01 APPT-MONTH      PIC XX.
01 APPT-YEAR       PIC XX.
01 APPT-HOUR       PIC XX.
01 APPT-MINUTE     PIC XX.
01 APPT-MERIDIEM   PIC XX.
01 APPT-VERIFY     PIC X.
01 EMPTY-LINE     PIC X(80).

*   The SCREEN SECTION designs the Daily Calendar, with a menu
*   screen from which the user selects an option:  to show
*   appointments, schedule an appointment, cancel an appointment,
*   and print the appointments.

SCREEN SECTION.

01 MENU-SCREEN BLANK SCREEN FOREGROUND-COLOR 7 BACKGROUND-COLOR 1.
02 MENU-SCREEN-2.
   03 TITLE-BAR
      FOREGROUND-COLOR 7 BACKGROUND-COLOR 4.
   04 LINE 1 PIC X(80) FROM EMPTY-LINE.
   04 LINE 1 COLUMN 32 VALUE "Daily Calendar".

   03 LINE 7 COLUMN 26
      PIC X TO ACCEPT-ITEM1.
   03 VALUE " Show appointments for a day ".
   03 LINE 9 COLUMN 26
      PIC X TO ACCEPT-ITEM1.
   03 VALUE " Schedule an appointment ".
   03 LINE 11 COLUMN 26
      PIC X TO ACCEPT-ITEM1.
   03 VALUE " Cancel an appointment ".
   03 LINE 13 COLUMN 26
      PIC X TO ACCEPT-ITEM1.
   03 VALUE " Print your appointments ".
```

(continued on next page)

# Using ACCEPT and DISPLAY Statements for Input/Output and Video Forms

## 11.3 Designing Video Forms with Screen Section ACCEPT and DISPLAY (Alpha, I64)

### Example 11-12 (Cont.) Designing a Video Form for a Daily Calendar (Alpha, I64)

```
03 HELP-TEXT
  FOREGROUND-COLOR 6 BACKGROUND-COLOR 0.
04 LINE 19 COLUMN 12
  VALUE
  " Use the arrow keys to move the cursor among menu items. ".
04 LINE 20 COLUMN 12
  VALUE
  " Press <Return> when the cursor is at the desired item. ".
04 LINE 21 COLUMN 12
  VALUE
  " Press <F10> to exit. "
```

```
01 SCHEDULE-SCREEN BLANK SCREEN.
02 TITLE-BAR
  FOREGROUND-COLOR 7 BACKGROUND-COLOR 4.
03 LINE 1 PIC X(80) FROM EMPTY-LINE.
03 LINE 1 COLUMN 30 VALUE "Schedule Appointment".

02 FIELDS-TEXT
  FOREGROUND-COLOR 7 BACKGROUND-COLOR 1.
03 LINE 5 VALUE " Description of Appointment: ".
03 LINE PLUS 4 VALUE " Date of Appointment (DD/MM/YY): ".
03 COLUMN PLUS 5 VALUE "/ /".
03 LINE PLUS 2 VALUE " Time of Appointment (HH:MM mm): ".
03 COLUMN PLUS 5 VALUE ":".

02 FIELDS-INPUT
  FOREGROUND-COLOR 7 BACKGROUND-COLOR 0 AUTO.
03 LINE 6 PIC X(160) TO APPT-NAME.
03 LINE 9 COLUMN 36 PIC XX USING APPT-DAY.
03 LINE 9 COLUMN 39 PIC XX USING APPT-MONTH.
03 LINE 9 COLUMN 42 PIC XX USING APPT-YEAR.
03 LINE 11 COLUMN 36 PIC XX USING APPT-HOUR.
03 LINE 11 COLUMN 39 PIC XX USING APPT-MINUTE.
03 LINE 11 COLUMN 42 PIC XX USING APPT-MERIDIEM.

02 HELP-TEXT
  FOREGROUND-COLOR 6 BACKGROUND-COLOR 0.
03 LINE 16 COLUMN 18
  VALUE " Use Cursor Keys to move within the fields. ".
03 LINE 17 COLUMN 18
  VALUE " Press <Tab> to enter next field. ".
03 LINE 18 COLUMN 18
  VALUE " Press <Return> when finished. "
```

```
01 VERIFY-SUBSCREEN FOREGROUND-COLOR 7 BACKGROUND-COLOR 1.
02 LINE 16 COLUMN 1 ERASE EOS.
02 LINE 17 COLUMN 25 VALUE " Is this entry correct? (Y/N): ".
02 PIC X USING APPT-VERIFY AUTO.
```

PROCEDURE DIVISION.  
P0.

DISPLAY MENU-SCREEN.

\* The cursor position is not within an item on the screen, so the  
\* first item in the menu will be accepted first.

MOVE 0 TO CURSOR-LINE, CURSOR-COL.

(continued on next page)

## Using ACCEPT and DISPLAY Statements for Input/Output and Video Forms

### 11.3 Designing Video Forms with Screen Section ACCEPT and DISPLAY (Alpha, I64)

#### Example 11–12 (Cont.) Designing a Video Form for a Daily Calendar (Alpha, I64)

```
* The user moves the cursor with the arrow keys to the
* desired menu item (to show, schedule, cancel, or print
* appointments) and selects the item by pressing <Return>.
* If the user wishes to exit without selecting an option,
* the user can press the F10 function key.

ACCEPT MENU-SCREEN.

IF KEY1 EQUAL "0"
    PERFORM OPTION_CHOSEN

ELSE IF KEY1 EQUAL "1" AND FKEY-10
    DISPLAY "You pressed the F10 key; exiting..." LINE 22.

STOP RUN.

OPTION_CHOSEN.

* For brevity, the sample program includes complete code
* for the "Schedule Appointment" screen only. A complete
* program for a calendar would also include code for
* displaying, canceling, and printing the day's appointments.

IF CURSOR-LINE = 7
    DISPLAY "You selected Show Appointments" LINE 22.

IF CURSOR-LINE = 9
    MOVE "01" TO APPT-DAY
    MOVE "01" TO APPT-MONTH
    MOVE "94" TO APPT-YEAR
    MOVE "12" TO APPT-HOUR
    MOVE "00" TO APPT-MINUTE
    MOVE "AM" TO APPT-MERIDIEM
    DISPLAY SCHEDULE-SCREEN

* The user types the description, date, and time of the
* appointment.

ACCEPT SCHEDULE-SCREEN

MOVE "Y" TO APPT-VERIFY
DISPLAY VERIFY-SUBSCREEN

* The user is asked, "Is this entry correct?" Answer is
* Y or N.

ACCEPT VERIFY-SUBSCREEN.

IF CURSOR-LINE = 11
    DISPLAY "You selected Cancel Appointments" LINE 22.

IF CURSOR-LINE = 13
    DISPLAY "You selected Print Appointments" LINE 22.

END PROGRAM MENU.
```





---

## Interprogram Communication

COBOL programs can communicate with each other, as well as with non-COBOL programs. Program-to-program communication is conducted by using one (or combinations) of the following:

- The CALL statement
- External data
- cobcall routine
- cobcancel routine
- cobfunc routine

This chapter includes the following information about interprogram communication:

- Multiple COBOL program run units (Section 12.1)
- COBOL program attributes (Section 12.2)
- Transferring flow of control (Section 12.3)
- Accessing another program's Data Division (Section 12.4)
- Communicating with contained COBOL programs (Section 12.5)
- Calling HP COBOL programs from other languages (Alpha, I64) (Section 12.6)
- Calling non-COBOL programs from HP COBOL (Section 12.7)
- Special considerations for interprogram communication (Section 12.8)

### 12.1 Multiple COBOL Program Run Units

A multiple COBOL program run unit consists of either of the following:

- One main (driver) program and one or more separately compiled programs; each program may or may not have contained programs
- One main program with one or more contained (nested) programs

Separately compiled programs can be concatenated in one source file, or can be written as separate source files.

#### 12.1.1 Examples of COBOL Run Units

Example 12–1 shows a run unit with three separately compiled programs, none of which have contained programs. MAIN-PROGRAM (❶) calls separate program SUB1 (❷), that calls separate program SUB2 (❸).

# Interprogram Communication

## 12.1 Multiple COBOL Program Run Units

### Example 12–1 Run Unit with Three Separately Compiled Programs

```
IDENTIFICATION DIVISION.          IDENTIFICATION DIVISION.
PROGRAM-ID. MAIN-PROGRAM. ❶      PROGRAM-ID. SUB1.          ❷
.
.
.
CALL SUB1.
.
.
STOP RUN.
END PROGRAM MAIN-PROGRAM

                                IDENTIFICATION DIVISION.
                                PROGRAM-ID. SUB2.          ❸
                                .
                                .
                                .
                                EXIT PROGRAM.
                                END PROGRAM SUB2.
```

---

#### Note

---

A separately compiled program has a nesting level number of 1. If this program contains other source programs, it is the outermost containing program. A contained program has a nesting level number greater than 1.

---

Example 12–2 shows a run unit with one main program (❷) and two contained programs (SUB1 (❸) is a directly contained program of MAIN-PROGRAM; SUB2 (❹) is an indirectly contained program of MAIN-PROGRAM).

Example 12–3 shows a run unit with three separately compiled programs (❷, ❸, and ❹). One of the separately compiled programs, MAIN-PROGRAM (❷), has two directly contained programs, SUB1 and SUB2 (❸ and ❹).

### 12.1.2 Calling Procedures

A COBOL main (driver) program calls subprograms (contained or separately compiled). Image execution begins and ends in the main program's Procedure Division. The program contains one or more CALL statements and is a calling program.

A COBOL subprogram is called by a main program or another subprogram. The subprogram may or may not contain CALL statements. If a subprogram contains a CALL statement, it is both a calling and a called program. If the subprogram does not contain a CALL statement, it is a called program only.

## Interprogram Communication

### 12.1 Multiple COBOL Program Run Units

#### Example 12–2 Run Unit with a Main Program and Two Contained Programs

```
IDENTIFICATION DIVISION.  
PROGRAM-ID. MAIN-PROGRAM. ④  
.  
.  
CALL SUB1.  
.  
.  
STOP RUN.  
  
IDENTIFICATION DIVISION.  
PROGRAM-ID. SUB1. ⑤  
.  
.  
CALL SUB2.  
EXIT PROGRAM.  
  
IDENTIFICATION DIVISION.  
PROGRAM-ID. SUB2. ⑥  
.  
.  
EXIT PROGRAM.  
  
END PROGRAM SUB2.  
END PROGRAM SUB1.  
END PROGRAM MAIN-PROGRAM.
```

#### Special Code for Programs Called “main” (Tru64 UNIX)

On the Tru64 UNIX operating system, if you have a main program called *main*, that program preempts a COBOL Run-Time Library (RTL) initialization routine also called *main*. This RTL routine is needed to make a *CALL data-name* statement (or *cobfunc*, *cobcall*, *cobcancel*) work correctly. Your program *main* must supply the necessary code by calling the *cob\_init* routine in the RTL. The *cob\_init* routine specification (in C) is as follows:

```
void cob_init (          /* init the RTL */  
    int argc,           /* argument count */  
    char **argv,        /* arguments */  
    char **envp         /* environment variable pointers */  
)
```

---

#### Note

---

An HP COBOL program called MAIN will only interfere with main if it was compiled with the *-names lowercase* flag.

---

◆

## 12.2 COBOL Program Attributes

Any HP COBOL program can have the *INITIAL* clause in the *PROGRAM-ID* paragraph. Data and files in a COBOL program can have the *EXTERNAL* clause.

## Interprogram Communication

### 12.2 COBOL Program Attributes

#### Example 12–3 Run Unit with Three Separately Compiled Programs, One with Two Contained Programs

```
IDENTIFICATION DIVISION.  
PROGRAM-ID. MAIN-PROGRAM. ⑦  
.  
.  
.  
CALL SUB1.  
CALL SUB2.  
.  
STOP RUN.  
  
IDENTIFICATION DIVISION.  
PROGRAM-ID. SUB1. ⑧  
.  
.  
.  
CALL SUB3.  
EXIT PROGRAM.  
END PROGRAM SUB1.  
  
IDENTIFICATION DIVISION.  
PROGRAM-ID. SUB2. ⑨  
.  
.  
.  
EXIT PROGRAM.  
END PROGRAM SUB2.  
END PROGRAM MAIN-PROGRAM.  
  
IDENTIFICATION DIVISION.  
PROGRAM-ID. SUB3. ⑩  
.  
.  
.  
CALL SUB4.  
.  
.  
.  
STOP RUN.  
  
IDENTIFICATION DIVISION.  
PROGRAM-ID. SUB4. ⑪  
.  
.  
.  
EXIT PROGRAM.
```

#### 12.2.1 The INITIAL Clause

A COBOL program with an INITIAL clause is returned to its initial state whenever that program exits. This ensures that it will be in its initial state the next time it is called.

During this initialization process, all internal program data whose description contains a VALUE clause is initialized to that defined value. Any item whose description does not include a VALUE clause will be initialized, and contain an undefined value.

When an INITIAL clause is present and when the program is called, an implicit CLOSE statement executes for all files in the open mode associated with internal file connectors.

When an INITIAL clause is not present, the status of the files and internal program data are the same as when the called program was exited.

The initial attribute is attained by specifying the INITIAL clause in the program's PROGRAM-ID paragraph. For example:

```
IDENTIFICATION DIVISION.  
PROGRAM-ID. TEST-PROG INITIAL.
```

### 12.2.2 The EXTERNAL Clause

Storage of data can be external or internal to the program in which the data is declared. A file connector can also be external or internal to the program in which it is defined.

External data or files can be referenced by every program in a run unit that describes that data or those files as external.

The EXTERNAL clause indicates that data or a file is external. This clause is specified only in File Description entries in the FILE SECTION or in Record Description entries in the WORKING-STORAGE Section. The EXTERNAL clause is one method of sharing data between programs. For example, in the following Working-Storage Section entry, the data items in RECORD-1 are available to any program in the image that also describes RECORD-1 and its data items as EXTERNAL:

```
01 RECORD-1 EXTERNAL.  
   03 ITEMA PIC X.  
   03 ITEMB PIC X(20).  
   03 ITEMC PIC 99.
```

---

**Note**

---

EXTERNAL files and data must be described identically in all programs in which they are defined.

---

## 12.3 Transferring Flow of Control

You control a multiple program run unit sequence by executing the following:

- A controlling CALL statement in the calling program (main or subprogram)
- An EXIT PROGRAM statement in the called subprogram

Contained COBOL programs have additional communication mechanisms that are explained in Section 12.5.

### 12.3.1 The CALL Statement

A CALL statement transfers the run unit's flow of control from the calling program to the beginning of the called subprogram's Procedure Division. Refer to the *HP COBOL Reference Manual* for the CALL statement format.

The first time the called subprogram gains the flow of control, it is in its initial state. Thereafter, each time it is called its state is the same as the last exit from that program, except when: (1) the called program has the INITIAL clause, or (2) the calling program cancels the called program.

## Interprogram Communication

### 12.3 Transferring Flow of Control

---

#### Note

---

A program cannot cancel itself nor can any program cancel the program that called it.

---

In COBOL programs, to call a routine named SPECIALROUTINE from an overlying COBOL program you might use:

```
MOVE "SPECIALROUTINE" TO ROUTINE-NAME.  
CALL ROUTINE-NAME.
```

If you need to call SPECIALROUTINE from a program in another language, use cobcall or cobfunc.

#### 12.3.2 Nesting CALL Statements

A called subprogram can itself transfer control flow after receiving control from a main program or another subprogram. This technique is known as CALL statement nesting. For example, Figure 12–1 shows a nested image that executes a series of three CALL statements from three separate programs.

**Figure 12–1 Nesting CALL Statements**

MAINPROG calls SUB,  
SUB then calls SUBA  
SUBA then calls SUBB

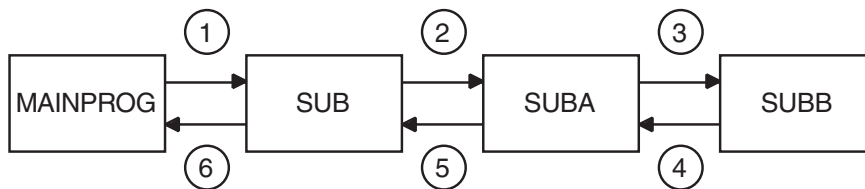

ZK-1475-GE

The MAINPROG, SUB1, and SUB2 programs in Example 12–4 illustrate their execution sequence by displaying a series of 12 messages on the default output device. Image execution begins in MAINPROG with message number 1. It ends in MAINPROG with message number 12. The image's message sequence is shown following the program listings.

#### Example 12–4 Execution Sequence of Nested CALL Statements

```
IDENTIFICATION DIVISION.  
*  
* MAINPROG is a calling program only  
*  
PROGRAM-ID. MAINPROG.  
ENVIRONMENT DIVISION.  
DATA DIVISION.  
PROCEDURE DIVISION.
```

(continued on next page)

## Interprogram Communication 12.3 Transferring Flow of Control

### Example 12-4 (Cont.) Execution Sequence of Nested CALL Statements

```
BEGIN.
  DISPLAY " 1. MAINPROG has control first.           ".
  DISPLAY " 2. MAINPROG transfers control to SUB1     ".
  DISPLAY "      upon executing the following CALL.   ".
  CALL "SUB1"
  DISPLAY "11. MAINPROG has control last.            ".
  DISPLAY "12. MAINPROG terminates the entire image upon ".
  DISPLAY "      execution of the STOP RUN statement. ".
  STOP RUN.
IDENTIFICATION DIVISION.
*
* SUB1 is both a called and calling subprogram
*
*   It is called by MAINPROG
*
*   It then calls SUB2
PROGRAM-ID. SUB1.
ENVIRONMENT DIVISION.
DATA DIVISION.
PROCEDURE DIVISION.
BEGIN.
  DISPLAY " 3.      This is the entry point to SUB1.   ".
  DISPLAY " 4. SUB1 now has control.                   ".
  DISPLAY " 5. SUB1 transfers control to SUB2.         ".
  CALL "SUB2"
  DISPLAY " 9. SUB1 regains control                    ".
  DISPLAY "10.      after executing the following     ".
  DISPLAY "      EXIT PROGRAM statement.              ".
  EXIT PROGRAM.
IDENTIFICATION DIVISION.
*
* SUB2 is called subprogram only
*
*   It is called by SUB1
*
PROGRAM-ID. SUB2.
ENVIRONMENT DIVISION.
DATA DIVISION.
PROCEDURE DIVISION.
BEGIN.
  DISPLAY " 6.      This is the entry point to SUB2.   ".
  DISPLAY " 7. SUB2 now has control.                   ".
  DISPLAY " 8. SUB2 returns control to SUB1            ".
  DISPLAY "      after executing the following         ".
  DISPLAY "      EXIT PROGRAM statement.                ".
  EXIT PROGRAM.
END PROGRAM SUB2.
END PROGRAM SUB1.
END PROGRAM MAINPROG.
```

Example 12-5 shows the messages printed to the default output device when the programs in Example 12-4 are run.

## Interprogram Communication

### 12.3 Transferring Flow of Control

#### Example 12–5 Sequence of Messages Displayed When Example 12–4 Is Run

1. MAINPROG has control first.
2. MAINPROG transfers control to SUB1  
upon executing the following CALL.
3. This is the entry point to SUB1.
4. SUB1 now has control.
5. SUB1 transfers control to SUB2.
6. This is the entry point to SUB2.
7. SUB2 now has control.
8. SUB2 returns control to SUB1  
after executing the following  
EXIT PROGRAM statement.
9. SUB1 regains control
10. after executing the following  
EXIT PROGRAM statement.
11. MAINPROG has control last.
12. MAINPROG terminates the entire image upon  
execution of the STOP RUN statement.

#### 12.3.3 The EXIT PROGRAM Statement

To return control to the calling program, the called subprogram executes an EXIT PROGRAM statement.

You can include more than one EXIT PROGRAM statement in a subprogram. However, if it appears in a consecutive sequence of imperative statements, the EXIT PROGRAM statement must appear as the last statement of the sequence. For example:

```
IF A = B DISPLAY "A equals B", EXIT PROGRAM.  
READ INPUT-FILE AT END DISPLAY "End of input file"  
PERFORM END-OF-FILE-ROUTINE  
EXIT PROGRAM.
```

If you do not include an EXIT PROGRAM statement in a subprogram, the compiler generates one at the end of the program.

On executing an EXIT PROGRAM statement in a called subprogram, control returns to the statement following the calling program's CALL statement or the first imperative statement in a NOT ON EXCEPTION clause specified for that CALL statement.

On executing an EXIT PROGRAM statement in a main program, the EXIT PROGRAM is ignored and control continues with the next statement.

Figure 12–2 shows how control is passed between programs.



## Interprogram Communication 12.3 Transferring Flow of Control

**Figure 12–2 Transfer of Control Flow from a Main Program to Multiple Subprograms**

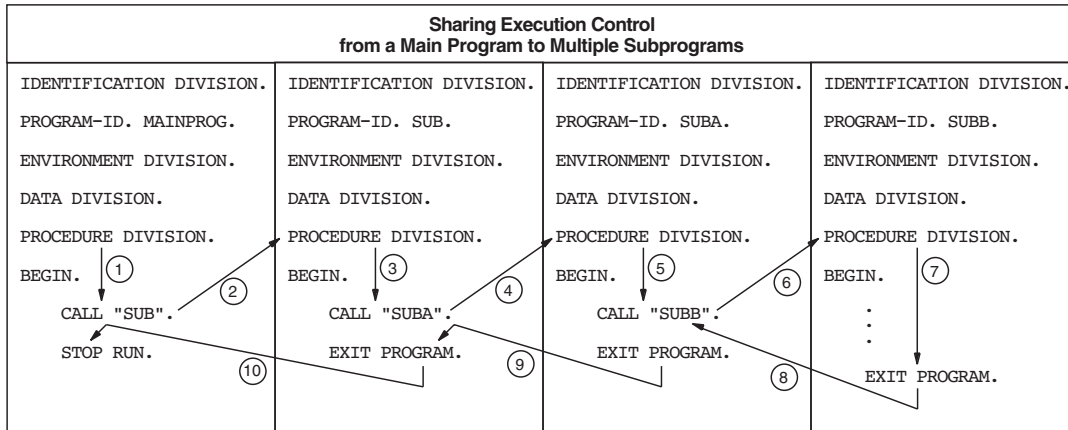

ZK-1474-GE

### 12.3.4 CALL Literal Versus CALL Data Name

CALL data name requires that all modules be specified to link the run unit. In Example 12–6 with 3 files (C1.COB, C2.COB, and C3.COB), there is no link-time reference to C3, but the C3 module must be explicitly included in the link of the run unit so that the C3 reference can be dynamically resolved at run-time.

#### Example 12–6 CALL Literal Versus CALL Data Name

```

IDENTIFICATION DIVISION.
PROGRAM-ID. C1.
ENVIRONMENT DIVISION.
DATA DIVISION.
WORKING-STORAGE SECTION.
01 W1 PIC XX VALUE "C3".
PROCEDURE DIVISION.
P0. DISPLAY "***C1***".
   CALL "C2".
   CALL W1.
   STOP RUN.
  
```

```

IDENTIFICATION DIVISION.
PROGRAM-ID. C2.
ENVIRONMENT DIVISION.
DATA DIVISION.
PROCEDURE DIVISION.
P0. DISPLAY "***C2***".
   EXIT PROGRAM.
  
```

```

IDENTIFICATION DIVISION.
PROGRAM-ID. C3.
ENVIRONMENT DIVISION.
DATA DIVISION.
PROCEDURE DIVISION.
P0. DISPLAY "***C3***".
   EXIT PROGRAM.
  
```

## Interprogram Communication

### 12.3 Transferring Flow of Control

Results for OpenVMS:

```
$ cobol c1,c2,c3
$ link c1
%LINK-W-NUDFSYMS, 1 undefined symbol:
%LINK-I-UDFSYM, C2
$ link c1,c2
$ run c1
***C1***
***C2***
%COB-F-CALL FAILED, call failed to find program C3
$ link c1,c2,c3
$ run c1
***C1***
***C2***
***C3***
```

Results for Tru64 UNIX:

```
csch> cobol c1.cob
ld:
Unresolved:
c2
cobol: Severe: Failed while trying to link.
csch> cobol c1.cob c2.cob
c1.cob:
c2.cob:
csch> a.out
***C1***
***C2***
cobrtl: severe: call failed to find program C3
csch> cobol c1.cob c2.cob c3.cob
c1.cob:
c2.cob:
c3.cob:
csch> a.out
***C1***
***C2***
***C3***
```

## 12.4 Accessing Another Program's Data Division

In a multiple COBOL program run unit, a called subprogram can access some of its calling program's Data Division. The calling program controls how much of it will be accessible to the called subprogram in the following ways:

- The USING phrase in both the CALL statement and the Procedure Division header (see Section 12.4.1)
- The Linkage Section (see Section 12.4.2)
- The EXTERNAL clause (see Section 12.2.2)
- The GLOBAL clause (see Section 12.5.2)

## Interprogram Communication

### 12.4 Accessing Another Program's Data Division

#### 12.4.1 The USING Phrase

To access a calling program's Data Division, use a CALL statement in the calling program and a Procedure Division USING phrase in the called program. The USING phrases of both the CALL statement and the Procedure Division header must contain an equal number of data names. (See Figure 12–3.)

**Figure 12–3 Accessing Another Program's Data Division**

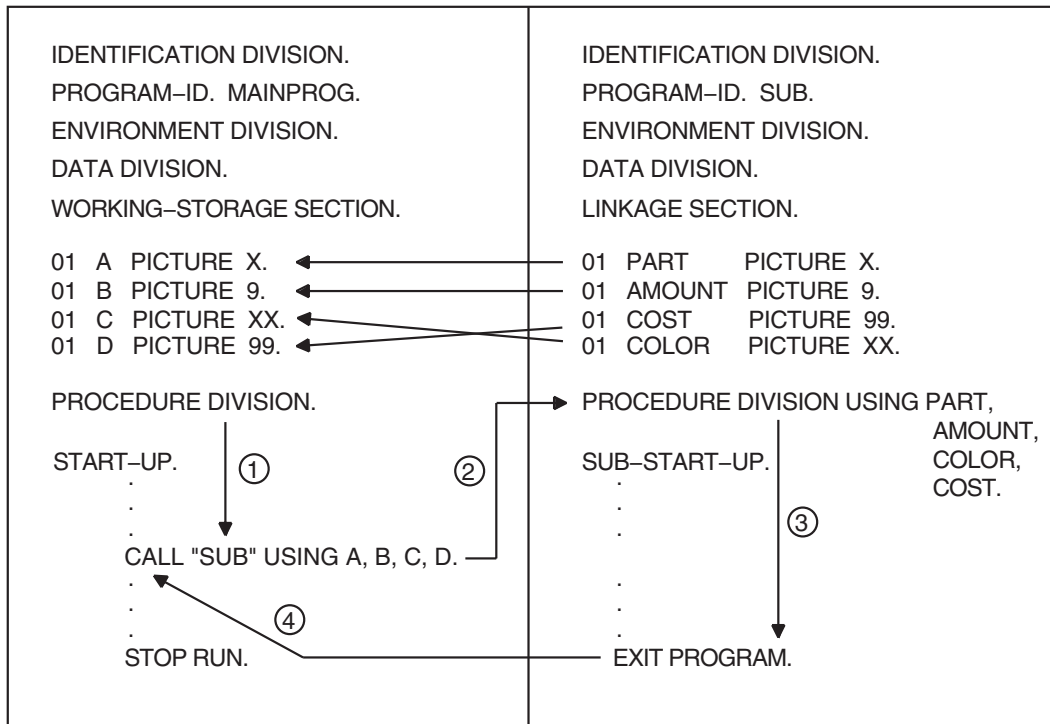

ZK-1731-GE

In Figure 12–3, when execution control transfers to SUB, it can access the four data items in the calling program by referring to the data names in its Procedure Division USING phrase. For example, the data names correspond as follows:

Data Name in MAINPROG (Calling Program)	Corresponding Data Name in SUB (Called Subprogram)
A	PART
B	AMOUNT
C	COLOR
D	COST

The CALL statement can make data available to the called program by the following argument-passing mechanisms:

- **REFERENCE**—The address of (pointer to) the argument (arg) is passed to the calling program. This is the default mechanism.

## Interprogram Communication

### 12.4 Accessing Another Program's Data Division

- **CONTENT**—The address of a copy of the contents of *arg* is passed to the called program. Note that since a copy of the data is passed, the called program cannot change the original calling program data.
- **VALUE**—The value of *arg* is passed to the called program. If *arg* is a data name, its description in the Data Division can be as follows: (a) COMP usage with no scaling positions (the PICTURE clause can specify no more than nine digits) and (b) COMP-1 usage.
- **On OpenVMS, DESCRIPTOR**—The address of (pointer to) the data item's descriptor is passed to the called program. ♦  
(Note that BY DESCRIPTOR is not supported by Tru64 UNIX. Refer to the *HP COBOL Reference Manual*, the CALL statement.)
- **OMITTED**—A value equivalent to BY VALUE 0 is passed to the called program. Note that OMITTED does not change the default mechanism.

---

#### Note

---

A called COBOL subprogram must have arguments passed to it using BY REFERENCE, which is the default, or BY CONTENT. BY VALUE, OMITTED, and BY DESCRIPTOR are HP extensions and will not work as expected if passed to a COBOL program. These argument-passing mechanisms are necessary when calling Run-Time Library Routines and system service routines as described in Chapter 13.

---

The mechanism for each argument in the CALL statement USING phrase must be the same as the mechanism for each argument in the called program's parameter list.

If the BY REFERENCE phrase is either specified or implied for a parameter, the called program references the same storage area for the data item as the calling program. This mechanism ensures that the contents of the parameter in the calling program are always identical to the contents of the parameter in the called program.

If the BY CONTENT phrase is either specified or implied for a parameter, only the initial value of the parameter is made available to the called program. The called program references a separate storage area for the data item. This mechanism ensures that the called program cannot change the contents of the parameter in the calling program's USING phrase. However, the called program can change the value of the data item referenced by the corresponding data name in the called program's Procedure Division header.

Once a mechanism is established in a CALL statement, successive arguments default to the established mechanism until a new mechanism is used. For example:

```
CALL "TESTPRO" USING ITEM-A  
    BY VALUE ITEM-B
```

Note that ITEM-A is passed using the BY REFERENCE phrase and that ITEM-B is passed using the BY VALUE phrase.

If the OMITTED phrase is specified for a parameter, the established call mechanism does not change.

## Interprogram Communication

### 12.4 Accessing Another Program's Data Division

One other mechanism of the CALL verb is the ability to use a GIVING phrase in the CALL statement. This allows the subprogram to return a value through the data item in the GIVING phrase. For example:

```
CALL "FUNCTION" USING ITEMA ITEMB
    GIVING ITEMC.
```

Values can also be returned through the BY REFERENCE parameter in the USING phrase. However, the GIVING phrase uses the return value by immediate value mechanism. Use of this mechanism requires that the GIVING result (ITEMC) be an elementary integer numeric data item with COMP, COMP-1, or COMP-2 usage and no scaling positions.

The RETURN-CODE special register provides an alternative mechanism for returning a value from a called program to the calling program.

The order in which USING identifiers appear in both calling and called programs determines the correspondence of single sets of data available to the called subprogram. The correspondence is by position, not by name.

#### 12.4.2 The Linkage Section

You must define each data name from the Procedure Division header's USING data name list in the called subprogram's Linkage Section. For example:

```
LINKAGE SECTION.
01 PART      PICTURE...
01 AMOUNT    PICTURE...
01 INVOICE   PICTURE...
01 COLOR     PICTURE...
01 COST      PICTURE...

PROCEDURE DIVISION USING PART, AMOUNT, COLOR, COST.
```

Of those data items you define in the Linkage Section, only those named in the calling program's Procedure Division header's USING phrase are accessible to the called program. In the previous example, INVOICE is not accessible from the called program.

When a subprogram references a data name from the Procedure Division header's USING data name list, the subprogram processes it according to the definition in its Linkage Section.

A called program's Procedure Division can reference data names in its Linkage Section only if it references one of the following:

- Any data item named in the Procedure Division USING data-name-list
- A data item that is subordinate to a Linkage Section data item in the Procedure Division USING data-name-list
- Any other association with a data item in the Procedure Division USING data-name-list; for example, index-name, redefinition, and so on

In Figure 12–4, SUB is called by MAINPROG. Because MAINPROG names FILE-RECORD and WORK-RECORD in its CALL "SUB" USING statement, SUB can reference these data names just as if they were in its own Data Division. However, SUB accesses these two data items with its own data names, F-RECORD and W-RECORD.

# Interprogram Communication

## 12.5 Communicating with Contained COBOL Programs

Figure 12–4 Defining Data Names in the Linkage Section

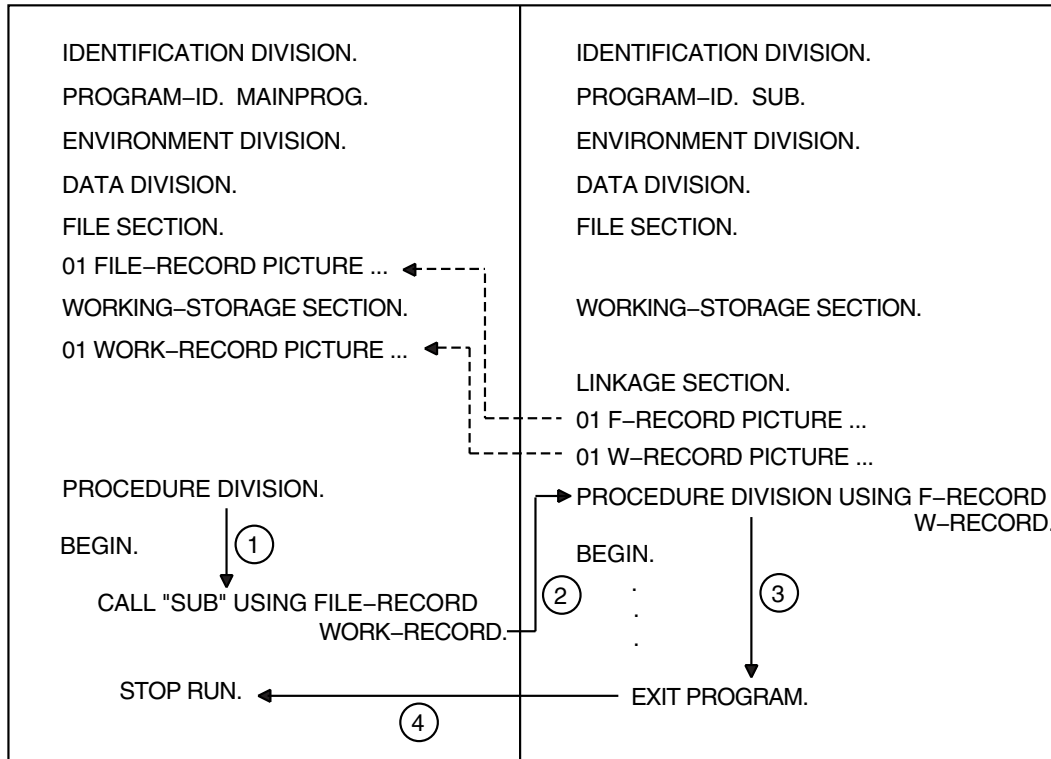

ZK-1477-GE

## 12.5 Communicating with Contained COBOL Programs

A contained COBOL program is a subprogram nested in another COBOL program (the containing program). The complete source of the contained program is found within the containing program. A contained program can also be a containing program.

A COBOL containing/contained program provides you with program and data attributes that noncontained COBOL programs do not have. These attributes, described in the next several sections, often allow you to more easily share and more conveniently access COBOL data items and other program resources.

This COBOL programming and data structuring capability encourages modular programming. In modular programming, you divide the solution of a large data processing problem into individual parts (the contained programs) that can be developed relatively independently.

Consequently, the use of the COBOL containing/contained block structure as a modular programming design can increase program efficiency and assist in program modification and maintainability.

The contained program uses all calling procedures described in Sections 12.3 and 12.4. However, when a contained program includes the COMMON clause (a program attribute) and the GLOBAL clause (a data and file trait), the additional rules described in the following sections apply.

## Interprogram Communication

### 12.5 Communicating with Contained COBOL Programs

#### 12.5.1 The COMMON Clause

The COMMON clause is a program attribute that can be applied to a directly contained program. The COMMON clause is a means of overriding normal scoping rules for program names, namely that a program that does not possess the common attribute and that is directly contained within another program can be referenced only by statements included in that containing program. For more information on Scope of Names rules, refer to the *HP COBOL Reference Manual*.

The common attribute is attained by specifying the COMMON clause in a program's Identification Division. A program that possesses the common attribute can be referenced by statements included in that containing program and by any programs directly or indirectly contained in that containing program, except the program possessing the common attribute and any programs contained within it.

Example 12–7 shows a run unit that has a COBOL program (PROG-MAIN) (❶) with three contained programs (❷, ❸, and ❹); one of which ((❷) has the COMMON clause. The example indicates which programs can call the common program.

#### Example 12–7 Using the COMMON Clause

```
IDENTIFICATION DIVISION.  
PROGRAM-ID. PROG-MAIN. ❶  
.  
.  
.  
CALL PROG-NAME-B  
.  
.  
.  
IDENTIFICATION DIVISION.  
PROGRAM-ID. PROG-NAME-B IS COMMON PROGRAM. ❷  
.  
.  
.  
IDENTIFICATION DIVISION.  
PROGRAM-ID. PROG-NAME-D. ❸  
.  
.  
.  
END PROGRAM PROG-NAME-D.  
END PROGRAM PROG-NAME-B.  
IDENTIFICATION DIVISION.  
PROGRAM-ID. PROG-NAME-C. ❹  
.  
CALL PROG-NAME-B  
.  
.  
END PROGRAM PROG-NAME-C.  
END PROGRAM PROG-MAIN.
```

PROG-NAME-B (❷) and PROG-NAME-C (❹) are directly contained in PROG-MAIN (❶); PROG-NAME-D (❸) is indirectly contained in PROG-MAIN.

## Interprogram Communication

### 12.5 Communicating with Contained COBOL Programs

PROG-MAIN (❶) can call PROG-NAME-B (❷) because PROG-MAIN directly contains PROG-NAME-B. PROG-NAME-B (❷) can call PROG-NAME-D (❸) because PROG-NAME-B directly contains PROG-NAME-D.

PROG-NAME-C (❹) can call PROG-NAME-B (❷) because:

- PROG-NAME-C is not contained in PROG-NAME-B
- PROG-NAME-B has the common attribute
- PROG-NAME-C is contained by PROG-MAIN

However, PROG-NAME-D (❸) cannot call PROG-NAME-B (❷) because PROG-NAME-D (❸) is contained within PROG-NAME-B (❷). Similarly, PROG-NAME-D (❸) cannot call PROG-NAME-C (❹) because PROG-NAME-C (❹) is not visible to PROG-NAME-D (❸). If PROG-NAME-C (❹) was made COMMON it could call PROG-NAME-D (❸). Additionally, PROG-NAME-C (❹) cannot call PROG-NAME-D (❸) because PROG-NAME-C (❹) is outside the scope of PROG-NAME-B (❷).

#### 12.5.2 The GLOBAL Clause

Data and files can be described as either global or local. A local name can be referenced only by the program that declares it. A global name is declared in only one program but can be referenced by both that program and any program contained in the program that declares the global name.

Some names are always global, other names are always local, and some names are either local or global depending on specifications in the program that declares the names. For more information on Scope of Names rules, refer to the *HP COBOL Reference Manual*.

##### 12.5.2.1 Sharing GLOBAL Data

A data name is global if the GLOBAL clause is specified in the Data Description entry by which the data name is declared or in another entry to which that Data Description entry is subordinate. If a program is contained within another program, both programs may reference data possessing the global attribute. The following example shows the Working-Storage Section of a containing program MAINPROG. Any contained program in MAINPROG, as well as program MAINPROG, can reference that data (unless the contained program declares other data with the same name).

```
WORKING-STORAGE SECTION.  
01  CUSTOMER-FILE-STATUS  PIC XX      GLOBAL.  
01  REPLY                 PIC X(10)   GLOBAL.  
01  ACC-NUM               PIC 9(18)   GLOBAL.
```

##### 12.5.2.2 Sharing GLOBAL Files

A file connector is global if the GLOBAL clause is specified in the File Description entry for that file connector. If a program is contained within another program, both programs may reference a file possessing the global attribute. The following example shows a file (CUSTOMER-FILE) with the GLOBAL clause in a containing program MAINPROG. Any contained program in MAINPROG, as well as program MAINPROG, can reference that file.



## Interprogram Communication

### 12.5 Communicating with Contained COBOL Programs

```
IDENTIFICATION DIVISION.  
PROGRAM-ID.  MAINPROG.  
.  
.  
.  
DATA DIVISION.  
FILE SECTION.  
FD  CUSTOMER-FILE  
   GLOBAL  
.  
.  
.
```

Any special registers associated with a GLOBAL file are also global.

#### 12.5.2.3 Sharing USE Procedures

The USE statement specifies declarative procedures to handle input/output errors. It also can specify procedures to be executed before the program processes a specific report group.

More than one USE AFTER EXCEPTION procedure in any given program can apply to an input/output operation when there is one procedure for file name and another for the applicable open mode. In this case, only the procedure for file name executes. Figure 12–5 shows that FILE-NAME-PROBLEM SECTION executes.

Figure 12–5 Sharing USE Procedures

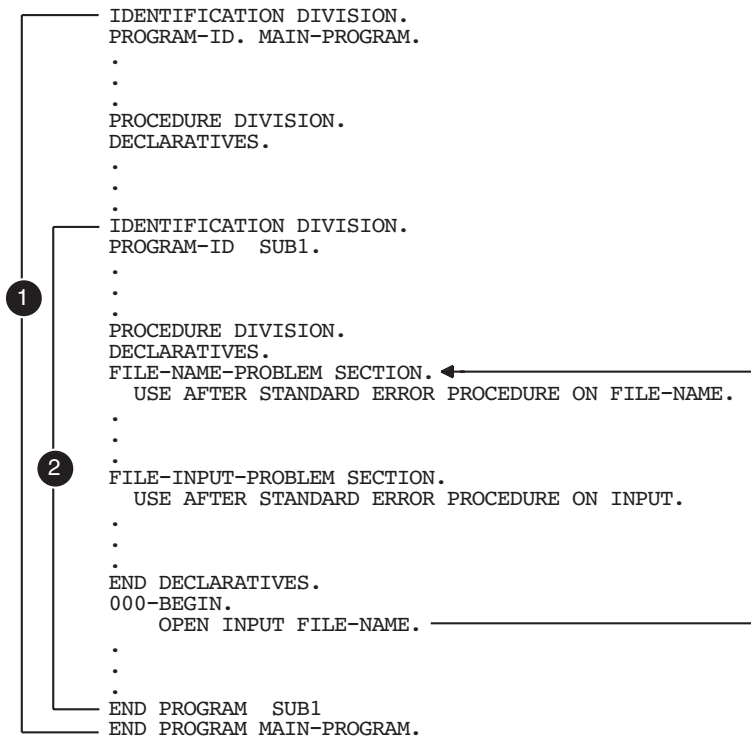

ZK-1429A-GE

# Interprogram Communication

## 12.5 Communicating with Contained COBOL Programs

At run time, two special precedence rules apply for the selection of a declarative when programs are contained in other programs. In applying these two rules, only the first qualifying declarative is selected for execution. The order of precedence for the selection of a declarative follows:

**Rule 1** —The declarative that executes first is the declarative within the program containing the statement that caused the qualifying condition. In Figure 12–6, FILE-NAME-PROBLEM procedure executes.

**Figure 12–6 Executing Declaratives with Contained Programs (Rule 1)**

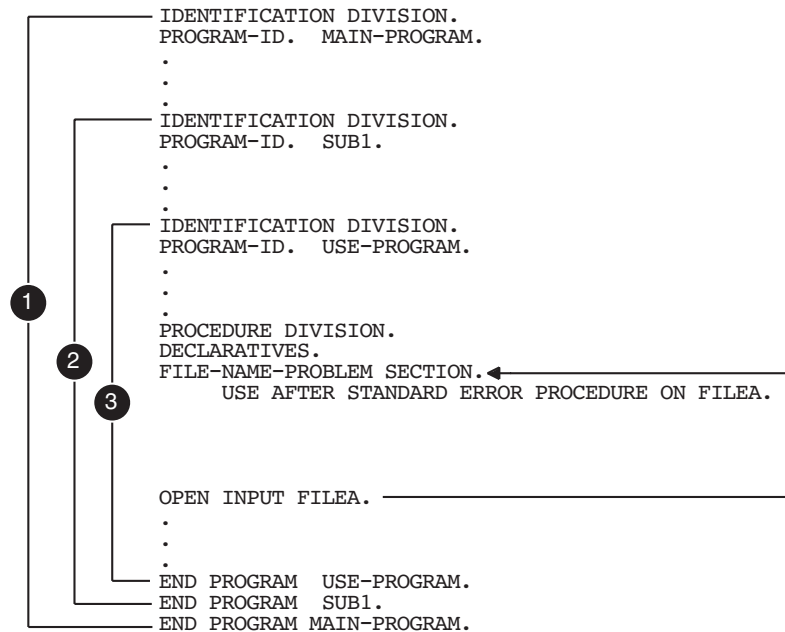

ZK-1428A-GE

**Rule 2** —If a declarative is not found using Rule 1, the Run-Time System searches all programs directly or indirectly containing that program for a global use procedure. This search continues until the Run-Time System either: (1) finds an applicable USE GLOBAL declarative, or (2) finds the outermost containing program. Either condition terminates the search; the second condition terminates both the search and the run unit.

Figure 12–7 shows applicable USE GLOBAL declaratives found in a containing program before the outermost containing program. Note that the first OPEN goes to the mode-specific program in the USE-PROGRAM rather than the file-specific procedure in the MAINPROG-PROGRAM.

For information on the negative effect of USE procedures that reference LINKAGE SECTION items on compiler optimization, see Section 15.5.4.

# Interprogram Communication

## 12.5 Communicating with Contained COBOL Programs

Figure 12–7 Executing Declaratives Within Contained Programs (Rule 2)

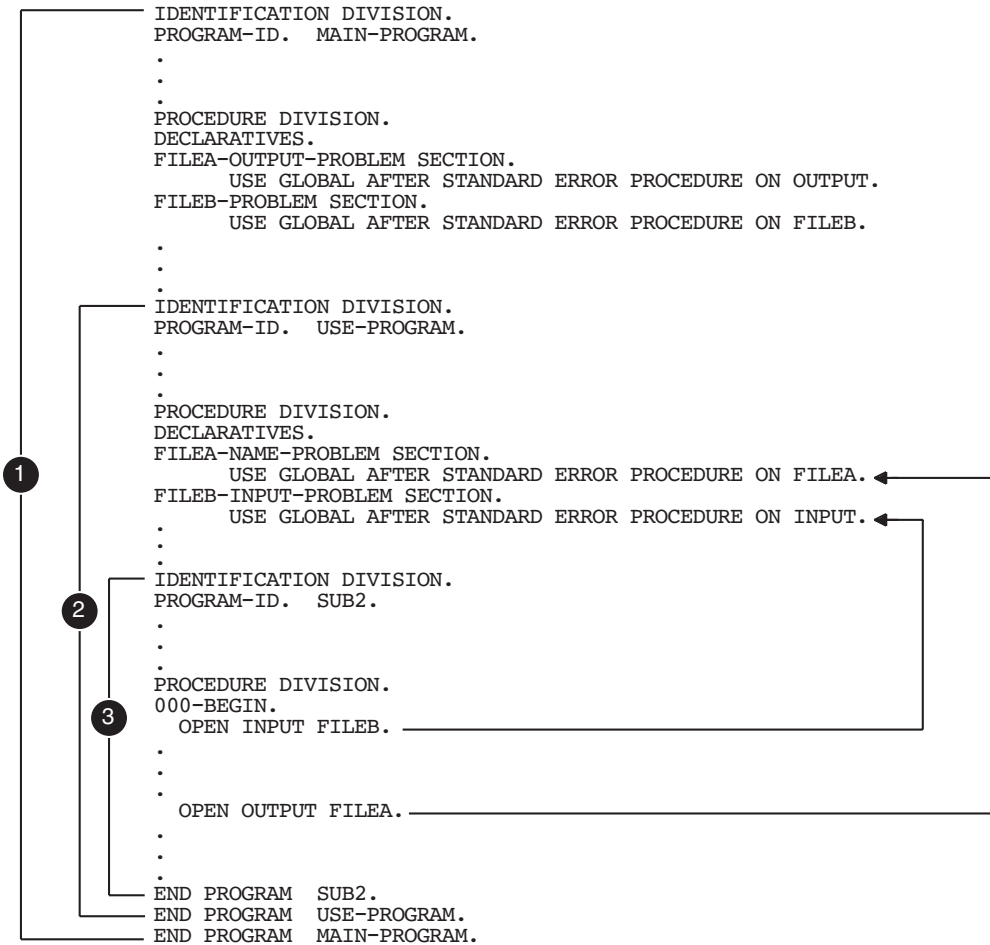

ZK-1427A-GE

### 12.5.2.4 Sharing Other Resources

Condition names, record names, and report names can also have the global attribute. Any program directly or indirectly contained within the program declaring the global name can reference the global name.

A condition name declared in a Data Description entry is global if the condition-variable it is associated with is a global name.

A record name is global if the GLOBAL clause is specified in the Record Description entry by which the record name is declared, or in the case of Record Description entries in the File Section, if the GLOBAL clause is specified in the File Description entry for the file name associated with the Record Description entry.

A report name is global if the GLOBAL clause is specified in the Report Description entry by which the report name is declared. In addition, if the Report Description entry contains the GLOBAL clause, the special registers LINE-COUNTER and PAGE-COUNTER are global names.

## Interprogram Communication

### 12.5 Communicating with Contained COBOL Programs

Because you cannot specify a Configuration Section for a program contained within another program, the following types of user-defined words are always global; that is, they are always accessible from within a contained program:

- Alphabet-name
- Class-name
- Condition-name
- Mnemonic-name
- Symbolic-character

These user-defined words can be referenced by statements and entries either in the program that contains the Configuration Section or any program contained in that program.

### 12.6 Calling HP COBOL Programs from Other Languages (Alpha, I64)

The CALL and CANCEL verbs allow you to call and cancel HP COBOL programs (including routines and separately compiled program units) from within an HP COBOL program. The cobcall, cobcancel, and cobfunc RTL calls allow you to call and cancel those programs from programs written in *other* languages.

When you use cobcall, cobcancel, and cobfunc, the same considerations and results will be in effect as if you had used the CALL and CANCEL statements (see Section 12.1.2 and Section 12.3).

If you need both a CANCEL (to reinitialize data) and a CALL, you can code it with a single cobfunc call. cobfunc is essentially a jacket that calls cobcancel and cobcall.

Table 12–1 shows these calls and their basic differences.

**Table 12–1 Calls to COBOL Programs (Alpha, I64)**

RTL Call	Function
cobcall	Calls a COBOL program. Program variables remain in their last state.
cobcancel	Cancels a COBOL program. Program variables are reset.
cobfunc	Calls a COBOL program then cancels it. Program variables are reset on exit.

#### 12.6.1 Calling COBOL Programs from C (Alpha, I64)

Using cobfunc.h as shown in Example 12–9, the C code in Example 12–8 demonstrates a program that calls a COBOL program with three arguments. In this example the COBOL program, CALLEDFROMC, expects two strings and an integer.

Example 12–9 could be used as an #include file for the cobfunc, cobcall, and cobcancel functions.

## Interprogram Communication

### 12.6 Calling HP COBOL Programs from Other Languages (Alpha, I64)

#### Example 12–8 Calling a COBOL Program from C (Alpha, I64)

```
#include <stdio.h>
#include "cobfunc.h"
extern int calledfromc();

main(int argc, char **argv)
{
    char *arg1="arg1 string";
    char *arg2="1234";
    int arg3 = 16587;
    int func_result;
    char *arglist[10];
#ifdef __osf
    cob_init(argc, argv, NULL);
#endif
    arglist[0] = arg1;
    arglist[1] = arg2;
    arglist[2] = (char *) &arg3;

    func_result = cobfunc ("calledfromc", 3, arglist);
}
```

#### Example 12–9 C Include File cobfunc.h (Alpha, I64)

```
void cobcancel ( /* CANCEL the named COBOL routine */
                char *name
                );

int cobcall ( /* Call a COBOL program from a C routine */
             char *name, /* READ: name of the program */
             int argc, /* READ: how many arguments */
             char **argv /* READ: array of pointers to the arguments */
             );

int cobfunc ( /* Call a COBOL program from a C routine, then CANCEL it */
             char *name, /* name of the program */
             int argc, /* how many arguments */
             char **argv /* array of pointers to the arguments */
             );

#ifdef __osf
void cob_init( /* init the RTL */
              int argc, /* argument count */
              char **argv, /* arguments */
              char **envp /* environment variable pointers */
              );
#endif
```

Note that argv[0] is the first argument to pass and argv[n-1] is the *n*th. The maximum number of arguments supported is 254. ♦

For Tru64 UNIX programs, if the main routine is written in C, it must call cob\_init. (See Section 12.1.2, Calling Procedures.) The HP COBOL program expects its arguments by reference. ♦

## Interprogram Communication

### 12.6 Calling HP COBOL Programs from Other Languages (Alpha, I64)

#### Example 12–10 COBOL Called Program "CALLEDFROMC" (Alpha, I64)

```
IDENTIFICATION DIVISION.  
PROGRAM-ID. CALLEDFROMC.  
DATA DIVISION.  
WORKING-STORAGE SECTION.  
01 TEST-RESET PIC X(10) VALUE "OFF".  
01 RETVAL PIC 9(5) COMP VALUE 357.  
LINKAGE SECTION.  
01 ARG1 PIC X(10).  
01 ARG2 PIC 9(4).  
01 ARG3 PIC 9(5) COMP.  
PROCEDURE DIVISION USING ARG1 ARG2 ARG3 GIVING RETVAL.  
P0.  
    DISPLAY "In CALLEDFROMC".  
    DISPLAY "test-reset is: " TEST-RESET  
    MOVE "on" TO TEST-RESET.  
    DISPLAY "arg1=" ARG1.  
    DISPLAY "arg1=" ARG1 ", arg2=" ARG2 ", arg3=" ARG3 WITH CONVERSION.  
END PROGRAM CALLEDFROMC.
```

#### Values Returned by cobcall and cobfunc (Alpha, I64)

The RTL calls `cobcall` and `cobfunc` can return a signed integer value from the `GIVING` clause of the COBOL program whose value is a longword integer (for example, `PIC S9(9) COMP`). The results of returning other values from the program called by `cobcall` or `cobfunc` are undefined.

Consider this example of the use of `cobcall`/`cobfunc`/`cobcancel` in a C program that uses `cobcall`, `cobfunc`, and `cobcancel` to call or cancel another COBOL program. Following is *prog.c*, the C program that calls the COBOL program:

## Interprogram Communication

### 12.6 Calling HP COBOL Programs from Other Languages (Alpha, I64)

#### Example 12–11 C Program Using `cobcall`, `cobfunc`, and `cobcancel` (Alpha, I64)

```
/* File: prog.c */
#include "stdlib.h"
#include "stdio.h"          /* printf */
#include "string.h"        /* strlen */
#define NUMARGS 4          /* up to 254 allowed */

void  cobcancel(char *name);
int   cobcall (char *name, int argc, char **argv);
int   cobfunc (char *name, int argc, char **argv);

void display(char *s, int r, int a);

extern int progcob();      /* COBOL returns int */

void mainx(){
  int  retval = 0;         /* progcob returns int */
  char *a_list[NUMARGS];  /* progcob needs 4 args */
  int  arg1 = 1, arg2 = 2, arg3 = 3, arg4 = 4;

  a_list[0] = (char *) &arg1; /* address of 1st arg */
  a_list[1] = (char *) &arg2; /* address of 2nd arg */
  a_list[2] = (char *) &arg3; /* address of 3rd arg */
  a_list[3] = (char *) &arg4; /* address of 4th arg */

  display("[0] All the initialized values", retval, arg1);

  retval = cobcall("progcob", NUMARGS, a_list);
  display("[1] After calling cobcall:", retval, arg1);

  retval = cobfunc("progcob", NUMARGS, a_list);
  display("[2] After calling cobfunc:", retval, arg1);

  retval = cobcall("progcob", NUMARGS, a_list);
  display("[3] After calling cobcall again:", retval, arg1);

  cobcancel("progcob");
  display("[4] After calling cobcancel:", retval, arg1);

  retval = cobcall("progcob", NUMARGS, a_list);
  display("[5] After calling cobcall again:", retval, arg1);
}

void display(char *s, int r, int a){
  unsigned int i = 0;
  printf("\n%s\n", s);
  for (i = 0; i < strlen(s); i++) printf("=");
  printf("\n  retval = %d", r);
  printf("\n  arg1   = %d", a);
  printf("\n");
}
```

Following is *progcob.cob*, the COBOL program that is called by the C program:

## Interprogram Communication

### 12.6 Calling HP COBOL Programs from Other Languages (Alpha, I64)

#### Example 12–12 COBOL Called Program "PROGCOB" (Alpha, I64)

```

identification division.
* File progcob.cob
*****
* The C program calls this COBOL program with four arguments:
*   arg1, arg2, arg3, arg4.
*
* This program performs:
*   arg1, myVal get the value of arg1 + arg2 + arg3 + arg4
*
* When cobfunc or cobcancel is called the values in
* working-storage are reset to their initial values.
*
* retVal: to demonstrate the value returned by this program.
* myVal : to demonstrate cobcancel in the C program
* arg1  : to demonstrate cobcall and cobfunc in the C program.
*****
program-id. progcob.
data division.
working-storage section.
01 retVal pic 9(9) comp value 987654321.
01 myVal  pic 9(9) comp value 0.
linkage section.
01 arg1   pic 9(9) comp value 0.
01 arg2   pic 9(9) comp value 0.
01 arg3   pic 9(9) comp value 0.
01 arg4   pic 9(9) comp value 0.
procedure division using
    arg1 arg2 arg3 arg4 giving retVal.
p0.  display " +----- From COBOL -----".
      display " | myVal = " myVal with conversion.
      display " | arg1  = " arg1  with conversion.
      display " | arg2  = " arg2  with conversion.
      display " | arg3  = " arg3  with conversion.
      display " | arg4  = " arg4  with conversion.
      display " | retVal = " retVal with conversion.
      add  arg1 arg2 arg3 arg4 giving arg1 myVal.
      display " + After 'add arg1 arg2 arg3 arg4 giving arg1 myVal':".
      display " | myVal = " myVal with conversion.
      display " | arg1  = " arg1  with conversion.
      display " | arg2  = " arg2  with conversion.
      display " | arg3  = " arg3  with conversion.
      display " | arg4  = " arg4  with conversion.
      display " | retVal = " retVal with conversion.
      display " +-----".

```

Note that the C program *progc.c* does not have a function called *main*. The function name "main" has to be renamed, because the COBOL RTL already contains a symbol called *main*. To resolve this, *progc.c* is called from a dummy COBOL program called *progmain.cob*. On Tru64 UNIX, if a COBOL routine is not the main program, you need to call *cob\_init*.

Here is *progmain.cob*:

```

identification division.
* file progmain.cob
program-id. progmain.
procedure division.
s1.
    call "mainx".
    stop run.
end program progmain.

```



## Interprogram Communication

### 12.6 Calling HP COBOL Programs from Other Languages (Alpha, I64)

The return value from the COBOL program is an int. Therefore, it is customary to use the int data type for the variables in C and COBOL programs that are passed back and forth. For example, `retval`, `arg1`, `arg2`, `arg3`, and `arg4` are declared as int and `pic(9)` in the C and COBOL programs, respectively.

Here are the commands to compile, link, and run on different platforms:

```
[OpenVMS] $ cobol PROGMAIN.COB, PROGC.COB
           $ cc PROGC.C
           $ link PROGMAIN.OBJ +PROGC.COB.OBJ +PROGC.OBJ  (*)
           $ run PROGMAIN.EXE

[UNIX]   % cobol progmain.cob progcob.cob prog.c  (*)
           % a.out
```

The order of listing at (\*) is fundamental. Here is a sample run:

```
[0] All the initialized values
=====
retval = 0
arg1   = 1
+----- From COBOL -----+
| myVal =      0
| arg1  =      1
| arg2  =      2
| arg3  =      3
| arg4  =      4
| retVal = 987654321
+ After 'add arg1 arg2 arg3 arg4 giving arg1 myVal':
| myVal =     10
| arg1  =     10
| arg2  =      2
| arg3  =      3
| arg4  =      4
| retVal = 987654321
+-----+

[1] After calling cobcall:
=====
retval = 987654321
arg1   = 10
+----- From COBOL -----+
| myVal =     10
| arg1  =     10
| arg2  =      2
| arg3  =      3
| arg4  =      4
| retVal = 987654321
+ After 'add arg1 arg2 arg3 arg4 giving arg1 myVal':
| myVal =     19
| arg1  =     19
| arg2  =      2
| arg3  =      3
| arg4  =      4
| retVal = 987654321
+-----+
```

## Interprogram Communication

### 12.6 Calling HP COBOL Programs from Other Languages (Alpha, I64)

```
[2] After calling cobfunc:
=====
retval = 987654321
arg1   = 19
+----- From COBOL -----
| myVal =      0
| arg1  =     19
| arg2  =      2
| arg3  =      3
| arg4  =      4
| retVal = 987654321
+ After 'add arg1 arg2 arg3 arg4 giving arg1 myVal':
| myVal =     28
| arg1  =     28
| arg2  =      2
| arg3  =      3
| arg4  =      4
| retVal = 987654321
+-----

[3] After calling cobcall again:
=====
retval = 987654321
arg1   = 28

[4] After calling cobcancel:
=====
retval = 987654321
arg1   = 28
+----- From COBOL -----
| myVal =      0
| arg1  =     28
| arg2  =      2
| arg3  =      3
| arg4  =      4
| retVal = 987654321
+ After 'add arg1 arg2 arg3 arg4 giving arg1 myVal':
| myVal =     37
| arg1  =     37
| arg2  =      2
| arg3  =      3
| arg4  =      4
| retVal = 987654321
+-----

[5] After calling cobcall again:
=====
retval = 987654321
arg1   = 37      ◆
```

### 12.7 Calling Non-COBOL Programs from HP COBOL

Because the HP COBOL compiler is part of a common language environment, an HP COBOL program can call a procedure written in another language available in this environment. This communication among high-level languages exists because these languages adhere to the *HP OpenVMS Calling Standard* or the *Tru64 UNIX Calling Standard for Alpha Systems*, as applicable, when generating a call to a procedure. Section 13.2 briefly describes the OpenVMS calling standard.

On Alpha and I64, for more information, refer to the material on calling system routines in the *OpenVMS Programming Concepts Manual*, the *OpenVMS RTL Library (LIB\$) Manual*, and the *OpenVMS System Services Reference Manual*. ◆

## Interprogram Communication

### 12.7 Calling Non-COBOL Programs from HP COBOL

#### 12.7.1 Calling a Fortran Program

Calling a procedure written in Fortran allows you to take advantage of features of that language. Example 12–13 demonstrates how to call a non-COBOL program in the run unit.

##### Example 12–13 Calling a Fortran Program from a COBOL Program

```
IDENTIFICATION DIVISION.
PROGRAM-ID.   GETROOT.
*****
* This program accepts a value from the terminal, *
* calls the Fortran subroutine SQROOT, and passes *
* the value as a character string. Program      *
* SQROOT returns the square root of the value.  *
*****
DATA DIVISION.
WORKING-STORAGE SECTION.
01 INPUT-NUMBER.
   03 INTEGER          PIC 9(5).
   03 DEC-POINT        PIC X(1).
   03 DECIMAL          PIC 9(8).
01 WORK-NUMBER.
   03 INTEGER          PIC 9(5).
   03 DECIMAL          PIC 9(8).
01 WORK-NUMBER-A REDEFINES WORK-NUMBER PIC 9(5)V9(8).
01 DISPLAY-NUMBER    PIC ZZ,ZZ9.9999.
PROCEDURE DIVISION.
STARTER SECTION.
SBEGIN.
  MOVE SPACES TO INPUT-NUMBER.
  DISPLAY "Enter number (with decimal point): "
    NO ADVANCING.
  ACCEPT INPUT-NUMBER.
  IF INPUT-NUMBER = SPACES
    GO TO ENDJOB.
  CALL "SQROOT" USING BY DESCRIPTOR INPUT-NUMBER.
  IF INPUT-NUMBER = ALL "*"
    DISPLAY "*** INVALID ARGUMENT FOR SQUARE ROOT"
  ELSE
    DISPLAY "The square root is: " INPUT-NUMBER
    INSPECT INPUT-NUMBER
      REPLACING ALL " " BY "0"
    MOVE CORRESPONDING INPUT-NUMBER TO WORK-NUMBER
    WORK-NUMBER-A TO DISPLAY-NUMBER
    DISPLAY DISPLAY-NUMBER.
  GO TO SBEGIN.
ENDJOB.
STOP RUN.
```

Example 12–14 shows the Fortran program SQROOT called by the program in Example 12–13 and sample output from the programs' execution.

The SQROOT subroutine accepts a 14-character string and decodes it into a real variable (DECODE is analogous to an internal READ). It then calls the SQRT function in the statement that encodes the result into the 14-character argument.

## Interprogram Communication

### 12.7 Calling Non-COBOL Programs from HP COBOL

#### Example 12–14 Fortran Subroutine SQROOT

```
      SUBROUTINE SQROOT(ARG)
      CHARACTER*14 ARG
      DECODE(14,10,ARG,ERR=20)VAL
10    FORMAT(F12.6)
      IF(VAL.LT.0.)GO TO 20
      ENCODE(14,10,ARG)SQRT(VAL)
999   RETURN
20    ARG='*****'
      GO TO 999
      END
```

#### Sample Run of GETROOT (OpenVMS)

```
$ RUN GETROOT 
Enter number (with decimal point): 25. 
The square root is:    5.000000
                    5.0000
Enter number (with decimal point): )HELLO 
** INVALID ARGUMENT FOR SQUARE ROOT
Enter number (with decimal point): 1000000. 
The square root is:  1000.000000
                    1,000.0000
Enter number (with decimal point): 2. 
The square root is:   1.414214
                    1.4142
Enter number (with decimal point): 
$
```

◆

#### 12.7.2 Calling a BASIC Program

The rich, yet easily accessed features of BASIC make that language a natural environment for development of short routines to be called from COBOL. Example 12–15 shows one example of an HP COBOL program that calls a BASIC program.

## Interprogram Communication 12.7 Calling Non-COBOL Programs from HP COBOL

### Example 12–15 Calling a BASIC Program from a COBOL Program

```
IDENTIFICATION DIVISION.
PROGRAM-ID.    APPL.
*****
* This COBOL program accepts credit application *
* information and passes this information to a BASIC *
* program that performs a credit analysis. Notice *
* that the data passed to the BASIC program is in *
* the standard binary format. *
*****
DATA DIVISION.
WORKING-STORAGE SECTION.
01 APPLICATION-NUMBER PIC 999.
01 C-APPLICATION-NUMBER PIC 9(3) COMP.
01 ANNUAL-SALARY PIC 9(5).
01 C-ANNUAL-SALARY PIC 9(5) COMP.
01 MORTGAGE-RENT PIC 999.
01 C-MORTGAGE-RENT PIC 9(3) COMP.
01 YEARS-EMPLOYED PIC 99.
01 C-YEARS-EMPLOYED PIC 9(2) COMP.
01 YEARS-AT-ADDRESS PIC 99.
01 C-YEARS-AT-ADDRESS PIC 9(2) COMP.
PROCEDURE DIVISION.
010-BEGIN.
    DISPLAY "Enter 3 digit application number".
    ACCEPT APPLICATION-NUMBER.
    IF APPLICATION-NUMBER = 999
        DISPLAY "All applicants processed" STOP RUN.
    MOVE APPLICATION-NUMBER TO C-APPLICATION-NUMBER.
    DISPLAY "Enter 5 digit annual salary".
    ACCEPT ANNUAL-SALARY.
    MOVE ANNUAL-SALARY TO C-ANNUAL-SALARY.
    DISPLAY "Enter 3 digit mortgage/rent".
    ACCEPT MORTGAGE-RENT.
    MOVE MORTGAGE-RENT TO C-MORTGAGE-RENT.
    DISPLAY "Enter 2 digit years employed by current employer".
    ACCEPT YEARS-EMPLOYED.
    MOVE YEARS-EMPLOYED TO C-YEARS-EMPLOYED.
    DISPLAY "Enter 2 digit years at present address".
    ACCEPT YEARS-AT-ADDRESS.
    MOVE YEARS-AT-ADDRESS TO C-YEARS-AT-ADDRESS.
    CALL "APP" USING BY REFERENCE C-APPLICATION-NUMBER
    C-ANNUAL-SALARY C-MORTGAGE-RENT
    C-YEARS-EMPLOYED C-YEARS-AT-ADDRESS.
    GO TO 010-BEGIN.
```

Example 12–16 shows the BASIC program APP called in Example 12–15, and sample output from the program's execution.

## Interprogram Communication

### 12.7 Calling Non-COBOL Programs from HP COBOL

#### Example 12–16 BASIC Program "APP" and Output Data

```
10 SUB APP (A%,B%,C%,D%,E%)
40 IF A% = 999 THEN 999
50 IF B% => 26000 THEN 800
60 IF B% => 18000 THEN 600
70 IF B% > 15000 THEN 500
80 IF B% => 10000 THEN 400
90 GO TO 700
400 IF E% < 4 THEN 800
410 IF D% < 2 THEN 800
420 GO TO 800
500 IF E% < 4 THEN 700
510 GO TO 800
600 LET X% = B% / 12
650 IF C% => X%/4 THEN 670
660 GO TO 800
670 IF E% => 4 THEN 800
700 PRINT TAB(1);"APPLICANT NUMBER ";A%; " REJECTED"
710 GO TO 999
800 PRINT TAB(1);"APPLICANT NUMBER ";A%;" ACCEPTED"
999 SUBEND
```

#### Sample Run of APPL

```
$ RUN APPL
Enter 3 digit application number
376 
Enter 5 digit annual salary
35000 
Enter 3 digit mortgage/rent
461 
Enter 2 digit years employed by current employer
03 
Enter 2 digit years at present address
05 
APPLICANT NUMBER 376 ACCEPTED
Enter 3 digit application number
999 
All applicants processed
```

### 12.7.3 Calling a C Program

Calling a program or routine that is written in C allows you to take advantage of features of that language. Example 12–17 features a C routine that can be called from a COBOL program.

Example 12–17 has two global external variables, `__Argc` and `**__Argv`. Note that `**__Argv[]` has an extra level of indirection; it is a pointer to a pointer to an array.

#### Example 12–17 C Routine to Be Called from a COBOL Program

```
/* crtn - c function to test use of argc and argv in c routines
 * called from HP COBOL */

#include "cobfunc.h"
#include <stdio.h>
```

(continued on next page)

## Interprogram Communication

### 12.7 Calling Non-COBOL Programs from HP COBOL

#### Example 12–17 (Cont.) C Routine to Be Called from a COBOL Program

```
extern int  _Argc;
extern char ** _Argv[];
#define argc  _Argc
#define argv (*_Argv)

void crtn()
{
    int i;

    i = 0;
    for (i = 0; i < argc; i++) {
        printf("argv[%d] = %s\n", i, argv[i]);
    }
}
```

Example 12–18 is a representation of how you can call a C program from your HP COBOL application. In this case, the C routine `crtn` (in Example 12–17) is called.

#### Example 12–18 Calling a C Program from a COBOL Program

```
IDENTIFICATION DIVISION.
PROGRAM-ID. CTEST.
DATA DIVISION.
WORKING-STORAGE SECTION.
.
.
.
PROCEDURE DIVISION.
MAIN SECTION.
A001-MAIN.
.
.
.
    CALL "crtn".
EXIT PROGRAM.
END PROGRAM CTEST.
```

For information on handling `LIB$INITIALIZE` when calling a C program, see Appendix B.

## 12.8 Special Considerations for Interprogram Communication

Certain situations require special consideration when your programs will communicate with other programs.

### 12.8.1 CALL and CANCEL Arguments

The `CALL` verb with a data item and the `CANCEL` verb with either a literal or a data item are implemented by a Run-Time Library routine that finds the appropriate program.

## Interprogram Communication

### 12.8 Special Considerations for Interprogram Communication

On Tru64 UNIX, these language features are implemented using `nlist`. Because of this implementation, the following items will not work on stripped images (for additional information on the `strip` command, refer to `strip(1)`):

- `CALL` data item
- `CANCEL` statement
- `cobcall` routine
- `cobcancel` routine
- `cobfunc` routine ♦

On OpenVMS, these features are implemented by depositing information in compiler generated `psects`. ♦

#### 12.8.2 Calling OpenVMS Alpha and I64 Shareable Images (OpenVMS)

When calling a subprogram installed as a shareable image, the program name specified in the `CALL` statement can be either a literal or a data-name. The same is true for the `CANCEL` verb. For more information on shareable images refer to HP COBOL online help file and the *OpenVMS Linker Utility Manual*. ♦

#### 12.8.3 Calling Tru64 UNIX Shareable Objects (Tru64 UNIX)

When you call a subprogram contained in a shared object, the program name specified in the `CALL` statement must be a literal. The `CANCEL` verb cannot be applied to programs in shared objects. For more information on shared objects, refer to the Tru64 UNIX programming documentation.

#### 12.8.4 Case Sensitivity on Tru64 UNIX

One difference between Tru64 UNIX and OpenVMS Alpha and I64 is case sensitivity. From program code creation, to your application internal operations, you must maintain an awareness of this issue when you consider porting COBOL source code between the platforms.

##### 12.8.4.1 Linker Case Sensitivity

The linker on Tru64 UNIX is case sensitive. “JOB1” is not the same routine as “job1”. However, COBOL is defined as a case *insensitive* language: `CALL` “job1” should invoke a routine whose PROGRAM-ID is JOB1. This is not true of case sensitive languages, such as C. The `names` option flag increases the flexibility of the HP COBOL compiler in communicating with case sensitive languages.

The `names` option has three values:

- `lower`—Forces all external data names, PROGRAM-ID names, and `CALL` literals to be lowercase. This is the default.
- `upper`—Forces all external data names, PROGRAM-ID names, and `CALL` literals to be uppercase.
- `as_is`—The case of literals used in `CALL` literals is taken as is. This is useful when you are calling subroutines with mixed case (for example, `GetStatusRoutine`). Data items defined with `EXTERNAL` will be treated as lowercase. PROGRAM-ID names will be treated as uppercase.

The `names` option flag does not apply to the `CANCEL` verb or to the `CALL` verb used with a data item. These language features are meaningful only when both the calling program and the called program are HP COBOL programs.



## Interprogram Communication

### 12.8 Special Considerations for Interprogram Communication

#### 12.8.4.2 Calling C Programs from HP COBOL on Tru64 UNIX

Because *lowercase* is the names option default, the names upper option is only required to call C functions whose names contain uppercase letters, as described in Table 12–2.

**Table 12–2 C Routine Called by Statement: CALL “Job1”**

FLAG, option	Routine Called
-names lowercase /names=lower	job1() {}
-names uppercase /names=upper	JOB1() {}
-names as_is /names=as_is	Job1() {}

For example, an HP COBOL program must be compiled with the names upper option to be able to call a C program named JOB1.

#### 12.8.4.3 Calling COBOL Programs from C on Tru64 UNIX

The lower and upper options to the -names flag and /names= option apply to the PROGRAM-ID as well as to the literals used with CALL literal. This makes it possible for C programs to call HP COBOL programs with either lowercase or uppercase names, as described in Table 12–3.

**Table 12–3 C Invocation to Call COBOL PROGRAM-ID “Job2”**

FLAG, option	Routine Called
-names lowercase /names=lower	job2();
-names uppercase /names=upper	JOB2();
-names as_is /names=as_is	not possible

The lower(case) and upper(case) options to the -names flag and /names= option preserve the semantics of calls among HP COBOL programs. However, the as\_is option does not preserve these semantics. For example, the following code fragment will have different behavior if compiled with as\_is.

```
PROGRAM ID JOB1.  
CALL "Job2."  
END-PROGRAM JOB1.  
PROGRAM ID JOB2.  
END-PROGRAM JOB2.
```

With the lower(case) and upper(case) options on the -names flag and /names= option, the program JOB2 will be called by JOB1. However, with the as\_is option, the linker will look to resolve a call to “Job2”—which in this case is just as different as if it were named job3, WORLD99, or any other routine name other than JOB2. ♦

## Interprogram Communication

### 12.8 Special Considerations for Interprogram Communication

#### 12.8.5 Additional Information

On OpenVMS, for more detailed information on system services and Run-Time Library routines, refer to the following manuals in the OpenVMS documentation set:

- Material on calling system routines in the *OpenVMS Programming Concepts Manual*
- *OpenVMS RTL Library (LIB\$) Manual*
- *OpenVMS System Services Reference Manual*

The following OpenVMS documentation mentioned in this chapter may also be of interest:

- *HP OpenVMS Calling Standard*
- *Guide to Creating OpenVMS Modular Procedures* ♦

For more detailed information on programming in the Tru64 UNIX environment, refer to the following manuals in the Tru64 UNIX documentation set:

- *Programmer's Guide*
- *Assembly Language Programmer's Guide*
- *Tru64 UNIX Calling Standard for Alpha Systems*

Refer to also the following:

- The man pages for information on system service routines in Tru64 UNIX.
- Reading an Indexed File from Other Languages on Tru64 UNIX section in Chapter 6 of this manual
- *HP COBOL Reference Manual*, CALL and CANCEL sections ♦

---

## Using HP COBOL in the Alpha, I64, or VAX Common Language Environment

The HP COBOL compiler is part of the common language environment. This environment defines certain calling procedures and guidelines that allow you to call programs written in different languages or prewritten system routines from HP COBOL. You can call the following routine types from HP COBOL:

- Subprograms written in other languages supported by Alpha, I64 or VAX
- Run-Time Library routines
- OpenVMS system services
- Tru64 UNIX library routines

On Tru64 UNIX, your HP COBOL programs can also call routines written in other languages, including system services routines on Tru64 UNIX. These calls must conform to the *Tru64 UNIX Calling Standard for Alpha Systems*.

For information on Tru64 UNIX, refer to the Tru64 UNIX operating system documentation. Alternatively, use the `man -k` command to search through the man pages for topics. For example, to find all routines containing the string “curses,” enter the following command:

```
% man -k curses
```

The operating system will display information similar to the following:

```
curses (3)           - Library that controls cursor movement and windowing
curses_intro (3)    - Introduction to the curses routines which optimizes
                    terminal screen handling and updating
restartterm (3)     - Restart terminal for curses application      ◆
```

### 13.1 Routines, Procedures, and Functions

The terms routine, procedure, and function are used throughout this chapter. A **routine** is a closed, ordered set of instructions that performs one or more specific tasks. Every routine has an entry point (the routine name) and optionally an argument list. Procedures and functions are specific types of routines: a **procedure** is a routine that does not return a value, whereas a **function** is a routine that returns a value by assigning that value to the function’s identifier. In COBOL, routines are also referred to as subprograms and called programs.

**System routines** are prewritten operating system routines that perform common tasks, such as finding the square root of a number or allocating virtual memory. You can call any system routine from your program, provided that COBOL supports the data structures required to call the routine. The system routines used most often are Run-Time Library routines and system services.

# Using HP COBOL in the Alpha, I64, or VAX Common Language Environment

## 13.1 Routines, Procedures, and Functions

For more information on system routines on OpenVMS Alpha and I64, refer to the *OpenVMS RTL Library (LIB\$) Manual* and the *OpenVMS System Services Reference Manual*. ♦

## 13.2 The OpenVMS Calling Standard (OpenVMS)

The *HP OpenVMS Calling Standard* and *OpenVMS Programming Interfaces: Calling a System Routine* (an archived manual still available on the documentation CD-ROM) describe the concepts used by all OpenVMS Alpha and VAX languages for invoking routines and passing data between them. The following attributes are specified by the *HP OpenVMS Calling Standard*:

- Register usage
- Stack usage
- Function value return
- Argument list

The following sections discuss these attributes in more detail. The *HP OpenVMS Calling Standard* also defines such attributes as the calling sequence, the argument data types and descriptor formats, condition handling, and stack unwinding. These attributes are discussed in detail in the *OpenVMS Programming Concepts Manual*.

### 13.2.1 Register and Stack Usage (Alpha, I64)

The OpenVMS Alpha and I64 architecture provides 32 general purpose integer registers (R0-R31) and 32 floating-point registers (F0-F31), each 64 bits in length. The *OpenVMS Programming Interfaces: Calling a System Routine* defines the use of these registers, as listed in Table 13–1.

**Table 13–1 OpenVMS Alpha and I64 Register Usage**

Register	Use
R0	Function value return register (see also F0, F1)
R1	Conventional scratch register
R2-R15	Conventional saved registers
R16-R21	Argument registers, one register per argument, additional arguments are placed on the stack
R22-R24	Conventional scratch registers
R25	Argument information (AI); contains argument count and argument type
R26	Return address (RA) register
R27	Procedure value (PV) register
R28	Volatile scratch register
R29	Frame pointer (FP)
R30	Stack pointer (SP)
R31	Read As Zero/Sink (RZ) register
PC	Program counter

(continued on next page)

# Using HP COBOL in the Alpha, I64, or VAX Common Language Environment

## 13.2 The OpenVMS Calling Standard (OpenVMS)

Table 13–1 (Cont.) OpenVMS Alpha and I64 Register Usage

Register	Use
F0,F1	Function value return registers for floating-point values (F1 is used if floating-point data exceeds 8 bytes)
F2-F9	Conventional saved registers for floating-point values
F10-F15	Conventional scratch registers for floating-point values
F16-F21	Argument registers for floating-point values (one per argument, additional arguments are placed on the stack)
F22-F30	Conventional scratch registers
F31	Read As Zero/Sink (RZ) register

A **stack** is a LIFO (last-in/first-out) temporary storage area that the system allocates for every user process. The system keeps information about each routine call in the current image on the call stack. Then, each time you call a routine, the system creates a structure on the stack, defined as a **stack frame** and further discussed in the *HP OpenVMS Calling Standard* and the *OpenVMS Programming Interfaces: Calling a System Routine*.

### 13.2.2 Return of the Function Value

A function is a routine that returns a single value to the calling routine. The **function value** represents the return value that is assigned to the function's identifier during execution. According to the *HP OpenVMS Calling Standard*, a function value may be returned as either an actual value or a condition value that indicates success or failure.

### 13.2.3 The Argument List

You can use an argument list to pass information to a routine and receive results.

For Alpha and I64 systems, the *HP OpenVMS Calling Standard* defines a data structure called an **argument list** as an **argument item sequence**, consisting of the first six arguments occupying six integer and six floating-point registers (R16-R21 and F16-F21), with additional argument placed on the stack. The argument information is contained in R25 (AI register). The stack pointer is contained in R30.

For detailed information, refer to the *HP OpenVMS Calling Standard*.

## 13.3 OpenVMS System Routines (OpenVMS)

**System routines** are OpenVMS routines that perform common tasks, such as finding the square root of a number or allocating virtual memory. You can call any system routine from your program, provided that HP COBOL supports the data structures required to call the routine.

The system routines used most often are OpenVMS Run-Time Library routines and system services. System routines are documented in detail in the *OpenVMS RTL Library (LIB\$) Manual* and the *OpenVMS System Services Reference Manual*.

# Using HP COBOL in the Alpha, I64, or VAX Common Language Environment

## 13.3 OpenVMS System Routines (OpenVMS)

### 13.3.1 OpenVMS Run-Time Library Routines

The OpenVMS Run-Time Library provides commonly used routines that perform a wide variety of functions. These routines are grouped according to the types of tasks they perform, and each group has a prefix that identifies those routines as members of a particular OpenVMS Run-Time Library facility. Table 13–2 lists all the language-independent Run-Time Library facility prefixes and the types of tasks each facility performs.

**Table 13–2 Run-Time Library Facilities (OpenVMS)**

Facility Prefix	Types of Tasks Performed
CVT\$	Library routines that handle floating-point data conversion
DTK\$	DECtalk routines that are used to control an HP DECTalk device
LIB\$	Library routines that: Obtain records from devices Manipulate strings Convert data types for I/O Allocate resources Obtain system information Signal exceptions Establish condition handlers Enable detection of hardware exceptions Process cross-reference data
MTH\$	Mathematics routines that perform arithmetic, algebraic, and trigonometric calculations
OTS\$	General-purpose routines that perform tasks such as data type conversions as part of a compiler's generated code
PPL\$	Parallel processing routines that help you implement concurrent programs on single-CPU and multiprocessor systems
SMG\$	Screen management routines that are used in designing, composing, and keeping track of complex images on a video screen
STR\$	String manipulation routines that perform such tasks as searching for substrings, concatenating strings, and prefixing and appending strings

### 13.3.2 System Services

System services are prewritten system routines that perform a variety of tasks, such as controlling processes, communicating among processes, and coordinating I/O.

Unlike the Run-Time Library routines, which are divided into groups by facility, all system services share the same facility prefix (SYS\$ on OpenVMS or SYS\_ on Tru64 UNIX). However, these services are logically divided into groups that perform similar tasks. Table 13–3 describes these groups.

**Table 13–3 System Services (OpenVMS)**

Group	Types of Tasks Performed
AST	Allows processes to control the handling of asynchronous system traps
Change Mode	Changes the access mode of particular routines

(continued on next page)

# Using HP COBOL in the Alpha, I64, or VAX Common Language Environment

## 13.3 OpenVMS System Routines (OpenVMS)

**Table 13–3 (Cont.) System Services (OpenVMS)**

Group	Types of Tasks Performed
Condition Handling	Designates condition handlers for special purposes
Event Flag	Clears, sets, reads, and waits for event flags, and associates with event flag clusters
Information	Returns information about the system, queues, jobs, processes, locks, and devices
Input/Output	Performs I/O directly, without going through RMS
Lock Management	Enables processes to coordinate access to shareable system resources
Logical Names	Provides methods of accessing and maintaining pairs of character-string logical names and equivalence names
Memory Management	Increases or decreases available virtual memory, controls paging and swapping, and creates and accesses shareable files of code or data
Process Control	Creates, deletes, and controls execution of processes
Security	Enhances the security of OpenVMS systems
Timer and Time Conversion	Schedules events and obtains and formats binary time values

### 13.4 Calling Routines

The basic steps for calling routines are the same whether you are calling a routine (subprogram) written in COBOL, a routine written in some other language, a system service, or a Run-Time Library routine. There are five steps required to call any system routine:

1. Determining the type of call
2. Defining the arguments
3. Calling the routine or service
4. Checking the condition value, if applicable
5. Locating the result

The following sections outline the steps for calling non-COBOL routines.

#### 13.4.1 Determining the Type of Call (OpenVMS)

Before you call an external routine, you must first determine whether the call should be a procedure call or a function call. In COBOL, a routine that does not return a value should be called as a procedure call. A routine that returns a value should be called as a function call. Thus, a function call returns one of the following:

- A function value (a COMP integer, COMP-1, or COMP-2 number). For example, on OpenVMS the call LIB\$INDEX returns an integer value.
- A return status, which is a longword (PIC 9(5) to 9(9) USAGE IS COMP) condition value that indicates the program has either successfully executed or failed. For example, on OpenVMS, LIB\$GET\_INPUT returns a return status.

## Using HP COBOL in the Alpha, I64, or VAX Common Language Environment

### 13.4 Calling Routines

Although you can call most system routines as a procedure call, it is recommended that you do so *only* when the system routine does not return a value. By checking the condition value, you can avoid errors.

The OpenVMS documentation on system services and Run-Time Library routines contains descriptions of each system routine and a description of the condition values returned. For example, the RETURNS section for the system routine LIB\$STAT\_TIMER follows:

#### RETURNS

OpenVMS	cond_value
usage:	longword (unsigned)
type:	write only
access:	by value
mechanism:	

Because LIB\$STAT\_TIMER returns a value, it should be called as a function. If a system routine contains the following description under the RETURNS section, you should call the system routine as a procedure call:

#### RETURNS

None.

#### 13.4.2 Defining the Argument (OpenVMS)

Most system routines have one or more arguments. These arguments are used to pass information to the system routine and to obtain information from it. Arguments can be either required or optional, and each argument has the following characteristics:

- Access type (read, write, modify...)
- Data type (floating point, longword...)
- Passing mechanisms (by value, by reference, by descriptor...)
- Argument form (scalar, array, string... )

To determine which arguments are required by a routine, check the format description of the routine in the OpenVMS documentation on system services or Run-Time Library routines. For example, the format for LIB\$STAT\_TIMER is as follows:

```
LIB$STAT_TIMER code ,value-argument [,handle-address]
```

The handle-address argument appears in square brackets ([ ]), indicating that it is an optional argument. Hence, when you call the system routine LIB\$STAT\_TIMER, only the first two arguments are required.



## Using HP COBOL in the Alpha, I64, or VAX Common Language Environment

### 13.4 Calling Routines

Once you have determined which arguments you need, read the argument description for information on how to call that system routine. For example, the system routine LIB\$STAT\_TIMER provides the following description of the code argument:

#### **code**

OpenVMS      longword\_signed  
Usage:        longword integer (signed)  
type:         read only  
access:       by reference  
mechanism:

Code that specifies the statistic to be returned. The **code** argument contains the address of a signed longword integer that is this code. It must be an integer from 1 to 5.

After you check the argument description, refer to Table 13–4 for the COBOL equivalent of the argument description. For example, the code argument description lists the OpenVMS usage entry longword\_signed. To define the code argument, use the COBOL equivalent of longword\_signed:

```
01 LWS      PIC S9(9) COMP.
```

Follow the same procedure for the value argument. The description of value contains the following information:

#### **value-argument**

OpenVMS      user\_arg  
Usage:        longword (unsigned)  
type:         write only  
access:       by reference  
mechanism:

The statistic returned by LIB\$STAT\_TIMER. The **value-argument** argument contains the address of a longword or quadword that is this statistic. All statistics are longword integers except elapsed time, which is a quadword.

For the value-argument argument, the OpenVMS usage, user\_arg, indicates that the data type returned by the routine is dependent on other factors. In this case, the data type returned is dependent upon which statistic you want to return. For example, if the statistic you want to return is code 5, page fault count, you must use a signed longword integer. Refer to Table 13–4 to find the following definition for a longword\_signed:

```
01 LWS      PIC S9(9) COMP.
```

Regardless of which Run-Time Library routine or system service you call, you can find the definition statements for the arguments in the OpenVMS usage in Table 13–4.

### 13.4.3 Calling the External Routine (OpenVMS)

Once you have decided which routine you want to call, you can access the routine using the CALL statement. You set up the call to the routine or service the same way you set up any call in COBOL. To determine the syntax of the CALL statement for a function call or a procedure call, refer to the *HP COBOL Reference Manual*, and see the examples in this chapter.

# Using HP COBOL in the Alpha, I64, or VAX Common Language Environment

## 13.4 Calling Routines

Remember, you must specify the name of the routine being called and all parameters required for that routine. Make sure the data types and passing mechanisms for the parameters you are passing coincide with those defined in the routine.

### 13.4.4 Calling System Routines (OpenVMS)

The basic steps for calling system routines are the same as those for calling any routine. However, when calling system routines, you need to provide some additional information discussed in the following sections.

#### 13.4.4.1 System Routine Arguments (OpenVMS)

All OpenVMS system routine arguments are described in terms of the following information:

- OpenVMS usage
- Data type
- Type of access allowed
- Passing mechanism

**OpenVMS usages** are data structures layered on the standard OpenVMS data types. For example, the OpenVMS usage `mask_longword` signifies an unsigned longword integer used as a bit mask, and the OpenVMS usage `floating_point` represents any OpenVMS floating-point data type. Table 13–4 lists the OpenVMS usages and the COBOL statements you need to implement them.

**Table 13–4 COBOL Implementation of the OpenVMS Data Types (OpenVMS)**

OpenVMS Data Type	COBOL Definition
<code>access_bit_names</code>	NA . . . PIC X(128). <sup>1</sup>
<code>access_mode</code>	NA . . . PIC X. <sup>1</sup> access_mode is usually passed BY VALUE as PIC 9(9) COMP.
<code>address</code>	USAGE POINTER.
<code>address_range</code>	01 ADDRESS-RANGE. 02 BEGINNING-ADDRESS USAGE POINTER. 02 ENDING-ADDRESS USAGE POINTER.
<code>arg_list</code>	NA . . . Constructed by the compiler as a result of using the COBOL CALL statement. An argument list may be created as follows, but may not be referenced by the COBOL CALL statement.  01 ARG-LIST. 02 ARG-COUNT PIC S9(9) COMP. 02 ARG-BY-VALUE PIC S9(9) COMP. 02 ARG-BY-REFERENCE USAGE POINTER 02 VALUE REFERENCE ARG-NAME. . . . continue as needed
<code>ast_procedure</code>	01 AST-PROC PIC 9(9) COMP. <sup>2</sup>

<sup>1</sup>Most OpenVMS data types not directly supported in COBOL can be represented as an alphanumeric data item of a certain number of bytes. While COBOL does not interpret the data type, it may be used to pass objects from one language to another.

<sup>2</sup>Although unsigned computational data structures are not directly supported in COBOL, you may substitute the signed equivalent provided you do not exceed the range of the signed data structure.

(continued on next page)

# Using HP COBOL in the Alpha, I64, or VAX Common Language Environment

## 13.4 Calling Routines

**Table 13–4 (Cont.) COBOL Implementation of the OpenVMS Data Types (OpenVMS)**

OpenVMS Data Type	COBOL Definition
boolean	01 BOOLEAN-VALUE PIC 9(9) COMP. <sup>2</sup>
byte_signed	NA . . . PIC X. <sup>1</sup>
byte_unsigned	NA . . . PIC X. <sup>1</sup>
channel	01 CHANNEL PIC 9(4) COMP. <sup>2</sup>
char_string	01 CHAR-STRING PIC X to PIC X(268435455).
complex_number	NA . . . PIC X(n) where n is length. <sup>1</sup>
cond_value	01 COND-VALUE PIC 9(9) COMP. <sup>2</sup>
context	01 CONTEXT PIC 9(9) COMP. <sup>2</sup>
date_time	NA . . . PIC X(8). <sup>1</sup>
device_name	01 DEVICE-NAME PIC X(n) where n is length.
d_floating	01 D-FLOAT USAGE COMP-2. (when /FLOAT=D_FLOAT)
ef_cluster_name	01 CLUSTER-NAME PIC X(n) where n is length.
ef_number	01 EF-NO PIC 9(9) COMP. <sup>2</sup>
exit_handler_block	NA . . . PIC X(n) where n is length. <sup>1</sup>
fab	NA . . . Too complex for general COBOL use. Most of a FAB structure can be described by a lengthy COBOL record description, but such a FAB cannot then be referenced by a COBOL I-O statement. It is much simpler to do the I-O completely within COBOL, and let the COBOL compiler generate the FAB structure, or do the I-O in another language.
file_protection	01 FILE-PROT PIC 9(4) COMP. <sup>2</sup>
function_code	01 FUNCTION-CODE. 02 MAJOR-FUNCTION PIC 9(4) COMP. <sup>2</sup> 02 SUB-FUNCTION PIC 9(4) COMP. <sup>2</sup>
f_floating	01 F-FLOAT USAGE COMP-1. (when /FLOAT=D_FLOAT or /FLOAT=G_FLOAT)
g_floating	01 G-FLOAT USAGE COMP-2. (when /FLOAT=G_FLOAT)
identifier	01 ID PIC 9(9) COMP. <sup>2</sup>
io_status_block	01 IOSB. 02 COND-VAL PIC 9(4) COMP. <sup>2</sup> 02 BYTE-CNT PIC 9(4) COMP. <sup>2</sup> 02 DEV-INFO PIC 9(9) COMP. <sup>2</sup>
item_list_2	01 ITEM-LIST-TWO. 02 ITEM-LIST OCCURS n TIMES. 04 COMP-LENGTH PIC S9(4) COMP. 04 ITEM-CODE PIC S9(4) COMP. 04 COMP-ADDRESS PIC S9(9) COMP. 02 TERMINATOR PIC S9(9) COMP VALUE 0.

<sup>1</sup>Most OpenVMS data types not directly supported in COBOL can be represented as an alphanumeric data item of a certain number of bytes. While COBOL does not interpret the data type, it may be used to pass objects from one language to another.

<sup>2</sup>Although unsigned computational data structures are not directly supported in COBOL, you may substitute the signed equivalent provided you do not exceed the range of the signed data structure.

(continued on next page)

# Using HP COBOL in the Alpha, I64, or VAX Common Language Environment

## 13.4 Calling Routines

**Table 13–4 (Cont.) COBOL Implementation of the OpenVMS Data Types (OpenVMS)**

OpenVMS Data Type	COBOL Definition
item_list_3	01 ITEM-LIST-3. 02 ITEM-LIST OCCURS n TIMES. 04 BUF-LEN PIC S9(4) COMP. 04 ITEM-CODE PIC S9(4) COMP. 04 BUFFER-ADDRESS PIC S9(9) COMP. 04 LENGTH-ADDRESS PIC S9(9) COMP. 02 TERMINATOR PIC S9(9) COMP VALUE 0.
item_list_pair	01 ITEM-LIST-PAIR. 02 ITEM-LIST OCCURS n TIMES. 04 ITEM-CODE PIC S9(9) COMP. 04 ITEM-VALUE PIC S9(9) COMP. 02 TERMINATOR PIC S9(9) COMP VALUE 0.
item_quota_list	NA
lock_id	01 LOCK-ID PIC 9(9) COMP. <sup>2</sup>
lock_status_block	NA
lock_value_block	NA
logical_name	01 LOG-NAME PIC X TO X(255).
longword_signed	01 LWS PIC S9(9) COMP.
longword_unsigned	01 LWU PIC 9(9) COMP. <sup>2</sup>
mask_byte	NA . . . PIC X. <sup>1</sup>
mask_longword	01 MLW PIC 9(9) COMP. <sup>2</sup>
mask_quadword	01 MQW PIC 9(18) COMP. <sup>2</sup>
mask_word	01 MW PIC 9(4) COMP. <sup>2</sup>
null_arg	CALL . . . USING OMITTED or PIC S9(9) COMP VALUE 0 passed USING BY VALUE.
octaword_signed	NA
octaword_unsigned	NA
page_protection	01 PAGE-PROT PIC 9(9) COMP. <sup>2</sup>
procedure	01 ENTRY-MASK PIC 9(9) COMP. <sup>2</sup>
process_id	01 PID PIC 9(9) COMP. <sup>2</sup>
process_name	01 PROCESS-NAME PIC X TO X(15).
quadword_signed	01 QWS PIC S9(18) COMP.
quadword_unsigned	01 QWU PIC 9(18) COMP. <sup>2</sup>
rights_holder	01 RIGHTS-HOLDER. 02 RIGHTS-ID PIC 9(9) COMP. <sup>2</sup> 02 ACCESS-RIGHTS PIC 9(9) COMP. <sup>2</sup>
rights_id	01 RIGHTS-ID PIC 9(9) COMP. <sup>2</sup>

<sup>1</sup>Most OpenVMS data types not directly supported in COBOL can be represented as an alphanumeric data item of a certain number of bytes. While COBOL does not interpret the data type, it may be used to pass objects from one language to another.

<sup>2</sup>Although unsigned computational data structures are not directly supported in COBOL, you may substitute the signed equivalent provided you do not exceed the range of the signed data structure.

(continued on next page)

# Using HP COBOL in the Alpha, I64, or VAX Common Language Environment

## 13.4 Calling Routines

**Table 13–4 (Cont.) COBOL Implementation of the OpenVMS Data Types (OpenVMS)**

OpenVMS Data Type	COBOL Definition
rab	NA . . . Too complex for general COBOL use. Most of a RAB structure can be described by a lengthy COBOL record description, but such a RAB cannot then be referenced by a COBOL I-O statement. It is much simpler to do the I-O completely within COBOL, and let the COBOL compiler generate the RAB structure, or do the I-O in another language.
section_id	01 SECTION-ID PIC 9(18) COMP. <sup>2</sup>
section_name	01 SECTION-NAME PIC X to X(43).
system_access_id	01 SECTION-ACCESS-ID PIC 9(18) COMP. <sup>2</sup>
s_floating	01 S-FLOAT USAGE COMP-1. (when /FLOAT=IEEE_FLOAT)
time_name	01 TIME-NAME PIC X(n) where n is the length.
t_floating	01 T-FLOAT USAGE COMP-2. (when /FLOAT=IEEE_FLOAT )
uic	01 UIC PIC 9(9) COMP. <sup>2</sup>
user_arg	01 USER-ARG PIC 9(9) COMP. <sup>2</sup>
varying_arg	Dependent upon application.
vector_byte_signed	NA . . . <sup>3</sup>
vector_byte_unsigned	NA . . . <sup>3</sup>
vector_longword_signed	NA . . . <sup>3</sup>
vector_longword_unsigned	NA . . . <sup>3</sup>
vector_quadword_signed	NA . . . <sup>3</sup>
vector_quadword_unsigned	NA . . . <sup>3</sup>
vector_word_signed	NA . . . <sup>3</sup>
vector_word_unsigned	NA . . . <sup>3</sup>
word_signed	01 WS PIC S9(4) COMP.
word_unsigned	01 WS PIC 9(4) COMP. <sup>2</sup>

<sup>2</sup>Although unsigned computational data structures are not directly supported in COBOL, you may substitute the signed equivalent provided you do not exceed the range of the signed data structure.

<sup>3</sup>COBOL does not permit the passing of variable-length data structures.

### 13.4.4.2 Calling a System Routine in a Function Call (OpenVMS)

In the following example, LIB\$STAT\_TIMER returns a condition value called RET-STATUS. To call this system routine, use the FORMAT of the function call described in the OpenVMS documentation on system services or Run-Time Library routines. In this case, the format is as follows:

```

01 ARG-CODE   PIC S9(9) COMP.
01 ARG-VALUE  PIC S9(9) COMP.
01 RET-STATUS PIC S9(9) COMP.
.
.
.
CALL "LIB$STAT_TIMER"
    USING BY REFERENCE ARG-CODE, ARG-VALUE
    GIVING RET-STATUS.

```

## Using HP COBOL in the Alpha, I64, or VAX Common Language Environment

### 13.4 Calling Routines

As stated earlier, this example does not pass a value for the optional handle-address argument.

The FORMAT will describe optional arguments in one of two ways:

```
[,optional-argument]
```

or

```
,[optional-argument]
```

If the comma appears outside of the brackets, you must pass a zero by value or use the OMITTED phrase to indicate the place of the omitted argument.

If the comma appears inside the brackets, you can omit the argument as long as it is the last argument in the list.

For example, look at the optional arguments of a hypothetical routine, LIB\$EXAMPLE\_ROUTINE:

```
LIB$EXAMPLE_ROUTINE arg1 [,arg2] [,arg3] [,arg4]
```

You can omit the optional arguments without using a placeholder:

```
CALL "LIB$EXAMPLE_ROUTINE"  
     USING ARG1  
     GIVING RET-STATUS.
```

However, if you omit an optional argument in the middle of the argument list, you must insert a placeholder:

```
CALL "LIB$EXAMPLE_ROUTINE"  
     USING ARG1, OMITTED, ARG3  
     GIVING RET-STATUS.
```

In general, Run-Time Library routines use the [,optional-argument] format, while system services use the ,[optional-argument] format.

In passing arguments to the procedure, you must define the passing mechanism required if it is not the default. The default passing mechanism for all COBOL data types is BY REFERENCE.

The passing mechanism required for a system routine argument is indicated in the argument description. The passing mechanisms allowed in system routines are those listed in the *HP OpenVMS Calling Standard*.

If the passing mechanism expected by the routine or service differs from the default mechanism in COBOL, you must override the default. To force an argument to be passed by a specific mechanism, refer to the following list:

- If the argument is described as “the address of,” use BY REFERENCE, which is the default.
- If the argument is described as “the value of,” use BY VALUE.
- If the argument is described as “address of descriptor,” use BY DESCRIPTOR.

---

#### Note

---

If a routine requires a passing mechanism that is not supported by COBOL, calling that routine from COBOL is not possible.

---

## Using HP COBOL in the Alpha, I64, or VAX Common Language Environment

### 13.4 Calling Routines

Even when you use the default passing mechanism, you can include the passing mechanism that is used. For example, to call LIB\$STAT\_TIMER, you can use either of the following definitions:

```
CALL "LIB$STAT_TIMER"  
    USING ARG-CODE, ARG-VALUE  
    GIVING RET-STATUS.  
  
CALL "LIB$STAT_TIMER"  
    USING BY-REFERENCE ARG-CODE, ARG-VALUE  
    GIVING RET-STATUS.
```

#### 13.4.4.3 Calling a System Routine in a Procedure Call (OpenVMS)

If the routine or service you are calling does not return a function value or condition value, you can call the system routine as a procedure. The same rules apply to optional arguments; you must follow the calling sequence presented in the FORMAT section of the OpenVMS documentation on system services or Run-Time Library routines.

One system routine that does not return a condition value or function value is the Run-Time Library routine LIB\$SIGNAL. LIB\$SIGNAL should always be called as a procedure, as shown in the following example:

```
01 ARG-VALUE PIC S9(5) COMP VALUE 90.  
  .  
  .  
  .  
  CALL "LIB$SIGNAL" USING BY VALUE ARG-VALUE.
```

#### 13.4.5 Checking the Condition Value (OpenVMS)

Many system routines return a condition value that indicates success or failure; this value can be either returned or signaled. In general, system routines return a condition value with the following exceptions:

- The system routine returns a function value.
- The CONDITION VALUES RETURNED is None.
- There is no CONDITION VALUES RETURNED description, but rather a CONDITION VALUES SIGNALLED description. (Success conditions are not signaled.)
- The call to the routine was made as a procedure call.

If any of these conditions apply, there is no condition value to check.

If there is a condition value, you must check this value to make sure that it indicates successful completion. All success condition values are listed in the CONDITION VALUES RETURNED description.

Condition values indicating success always appear first in the list of condition values for a particular routine, and success codes always have odd values. A success code common to many system routines is the condition value SS\$\_NORMAL, which indicates that the routine completed normally and successfully. You can reference the condition values symbolically in your COBOL program by specifying them in the EXTERNAL phrase of the VALUE IS clause. Symbolic names specified in VALUE IS EXTERNAL become link-time constants; that is, the evaluation of the symbolic name is deferred until link time because it is known only at link time.

# Using HP COBOL in the Alpha, I64, or VAX Common Language Environment

## 13.4 Calling Routines

For example:

```
01 SS$_NORMAL PIC S9(5) COMP VALUE EXTERNAL SS$_NORMAL
  .
  .
  .
  CALL "LIB$STAT_TIMER" USING ARG-CODE, ARG-VALUE GIVING RET-STATUS.
  IF RET-STATUS NOT EQUAL SS$_NORMAL...
```

Because all success codes have odd values, you can check a return status for any success code. For example, you can cause execution to continue only if a success code is returned by including the following statement in your program:

```
IF RET-STATUS IS SUCCESS ...
```

Sometimes several success condition values are possible. You may only want to continue execution on specific success codes.

For example, the \$SETEF system service returns one of two success values: SS\$\_WASSET or SS\$\_WASCLR. If you want to continue only when the success code SS\$\_WASSET is returned, you can check for this condition value as follows and branch accordingly:

```
IF RET-STATUS EQUAL SS$_WASSET ...
```

or

```
EVALUATE RET-STATUS
  WHEN SS$_WASSET ...
```

If the condition value returned is not a success condition, then the routine did not complete normally, and the information it should have returned may be missing, incomplete, or incorrect.

You can also check for specific error conditions as follows:

```
WORKING-STORAGE SECTION.
01 USER-LINE      PIC X(30).
01 PROMPT-STR    PIC X(16) VALUE IS "Type Your Name".
01 OUT-LEN       PIC S9(4) USAGE IS COMP.
01 COND-VALUE    PIC S9(9) USAGE IS COMP.
88 LIB$_INPSTRTRU VALUE IS EXTERNAL LIB$_INPSTRTRU.
  .
  .
  .

PROCEDURE DIVISION.
P0.
  CALL "LIB$GET_INPUT" USING BY DESCRIPTOR USER-LINE PROMPT-STR
                          BY REFERENCE OUT-LEN
                          GIVING COND-VALUE.

  EVALUATE TRUE
    WHEN LIB$_INPSTRTRU
      DISPLAY "User name too long"
    WHEN COND-VALUE IS FAILURE
      DISPLAY "More serious error".
  .
  .
  .
```



# Using HP COBOL in the Alpha, I64, or VAX Common Language Environment

## 13.4 Calling Routines

### 13.4.5.1 Library Return Status and Condition Value Symbols (OpenVMS)

Library return status and condition value symbols have the following general form:

fac\$\_abcmnoxyz

where:

- fac is a 2- or 3-letter facility symbol (LIB, MTH, STR, OTS, BAS, COB, FOR, SS).
- abc are the first 3 letters of the first word of the associated message.
- mno are the first 3 letters of the next word.
- xyz are the first 3 letters of the third word, if any.

Articles and prepositions are not considered significant words in this format. If a significant word is only two letters long, an underscore character is used to fill out the third space. The OpenVMS normal or success code is used to indicate successful completion. Some examples of this code are as follows:

RETURN Status	Meaning
LIB\$_INSVIRMEM	Insufficient virtual memory
FOR\$_NO_SUCDEV	No such device
MTH\$_FLOOVEMAT	Floating overflow in Math Library procedure
BAS\$_SUBOUTRAN	Subscript out of range

### 13.4.6 Locating the Result (OpenVMS)

Once you have defined the arguments, called the procedure, and checked the condition value, you are ready to locate the result. To find out where the result is returned, look at the description of the system routine you are calling.

For example, in the following call to MTH\$ACOS the result is written into the variable COS:

```
01 ARG-CODE PIC S9(9) COMP VALUE 1.  
01 COS          COMP1 VALUE 0.  
:  
:  
CALL "MTH$ACOS" USING BY REFERENCE ARG-CODE GIVING COS.
```

This result is described in the OpenVMS documentation on system services and Run-Time Library routines, under the description of the system routine.

## 13.5 Establishing and Removing User Condition Handlers (OpenVMS)

To establish a user condition handler, call the LIB\$ESTABLISH routine.

The form of the call is as follows:

```
CALL LIB$ESTABLISH USING BY VALUE new-handler GIVING old-handler
```

## Using HP COBOL in the Alpha, I64, or VAX Common Language Environment

### 13.5 Establishing and Removing User Condition Handlers (OpenVMS)

#### **new-handler**

Specifies the name of the routine to be set up as a condition handler.

#### **old-handler**

Receives the address of the previously established condition handler.

The GIVING phrase is optional.

LIB\$ESTABLISH moves the address of the condition-handling routine into the appropriate process context and returns the address of a previously established condition handler.

The handler itself could be a user-written routine, or a library routine. The following example shows how a call to establish a user-written handler might be coded:

```
01 HANDLER      PIC S9(9) COMP VALUE EXTERNAL HANDLER_ROUT.
01 OLD-HANDLER  PIC S9(9) COMP.
.
.
.
      CALL "LIB$ESTABLISH" USING BY VALUE HANDLER GIVING OLD-HANDLER.
```

In the preceding example, HANDLER\_ROUT is the name of a program that is established as the condition handler for the program unit containing these source statements. A program unit can remove an established condition handler in two ways:

- Issue another LIB\$ESTABLISH call which specifies a different handler.
- Issue the LIB\$REVERT call.

The LIB\$REVERT call has no arguments:

```
CALL "LIB$REVERT" .
```

This call removes the condition handler established in the current program unit.

Note that the LIB\$ESTABLISH and LIB\$REVERT routines only affect user condition handlers, not the default HP COBOL condition handler. When an exception occurs, the user condition handler, if one exists, is executed first, followed by the HP COBOL condition handler, *if* the user condition handler could not handle the exception.

When a program unit returns to its caller, the condition handler associated with that program unit is automatically removed (the program unit's stack frame, which contains the condition handler address, is removed from the stack).

Example 13–1 illustrates a user written condition handling routine that determines the reason for a system service failure. The example handler handles only one type of exception, system service failures. All other exceptions are resignalled, allowing them to be handled by the system default handlers. This handler is useful because the system traceback handler indicates only that a system service failure occurred, not which specific error caused the failure.

LIB\$ESTABLISH is used by the main program, SSSCOND, to establish the user written condition handler, SSHAND. System service failure mode is enabled so that errors in system service calls will initiate a search for a condition handler.

## Using HP COBOL in the Alpha, I64, or VAX Common Language Environment

### 13.5 Establishing and Removing User Condition Handlers (OpenVMS)

The condition handler is written as a subprogram that returns a result. The result indicates whether or not the condition handler handled the exception. Note that space must be allocated in the LINKAGE SECTION for the signal and mechanism arrays. The mechanism array always contains five elements, but the signal array varies according to the number of additional arguments.

When an exception occurs, the user condition handler is invoked first. The handler checks the error condition to determine if it is one that it can handle (the LIB\$MATCH\_COND routine would be useful here if the routine wanted to check for one of a collection of conditions). If the exception is not handled by this condition handler, then the default COBOL condition handler is invoked. If the default COBOL condition handler does not handle the exception, then the exception is handled by the operating system.

#### Example 13-1 User-Written Condition Handler

```
IDENTIFICATION DIVISION.
PROGRAM-ID.      SSSCOND.
DATA DIVISION.
WORKING-STORAGE SECTION.

01      SSHANDA          PIC S9(9) COMP VALUE EXTERNAL SSHAND.
PROCEDURE DIVISION.
BEGIN.
*
*      Establish condition handler
CALL "LIB$ESTABLISH" USING BY VALUE SSHANDA.
*
*      Enable system service failure mode
CALL "SYS$SETSEFM" USING BY VALUE 1.
*
*      Generate a bad system service call
CALL "SYS$QIOW" USING BY VALUE 0 0 0 0
                                0 0 0 0
                                0 0 0 0.

      STOP RUN.
END PROGRAM SSSCOND.

IDENTIFICATION DIVISION.
*
PROGRAM-ID.      SSHAND.
*
*      This routine is to be used as a condition handler
*      for system service failures.
*
*      If this routine does not remedy the exception condition, it will
*      return with a value of SS$_RESIGNAL. If the routine does remedy
*      the exception condition, then it should return with a value of
*      SS$_CONTINUE.
*
DATA DIVISION.
```

(continued on next page)

# Using HP COBOL in the Alpha, I64, or VAX Common Language Environment

## 13.5 Establishing and Removing User Condition Handlers (OpenVMS)

### Example 13-1 (Cont.) User-Written Condition Handler

```
WORKING-STORAGE SECTION.
01    SS_HAND          PIC S9(9) COMP.
01    SS$_SSFAIL      PIC S9(9) COMP VALUE EXTERNAL SS$_SSFAIL.
01    SS$_RESIGNAL    PIC S9(9) COMP VALUE EXTERNAL SS$_RESIGNAL.
01    MSGLEN          PIC S9(4) COMP.
01    MSGID           PIC S9(9) COMP.
01    ERRMSG          PIC X(80).
01    STAT            PIC S9(9) COMP.

LINKAGE SECTION.
01    SIGNAL_ARRAY.
      03    SIGNAL_ARGS    PIC 9(9) COMP.
      03    SIGNAL        OCCURS 4 TO 10 TIMES
                          DEPENDING ON SIGNAL_ARGS.
      05    SIGNAL_VALUE  PIC S9(9) COMP.
01    MECHANISM_ARRAY.
      03    MECH_ARGS     OCCURS 5 TIMES.
      05    MECH         PIC 9(9) COMP.

PROCEDURE DIVISION USING SIGNAL_ARRAY MECHANISM_ARRAY
                      GIVING SS_HAND.
BEGIN.
*
*      Initialize the return result
*
      MOVE SS$_RESIGNAL TO SS_HAND.
      IF SIGNAL_VALUE(1) NOT EQUAL SS$_SSFAIL
      THEN
          MOVE SS$_RESIGNAL TO SS_HAND
      ELSE
*
*          Disable system service failure mode
*
          CALL "SYS$SETSFM" USING BY VALUE 0
          MOVE SIGNAL(2) TO MSGID
          CALL "SYS$GETMSG" USING BY VALUE MSGID
                                BY REFERENCE MSGLEN
                                BY DESCRIPTOR ERRMSG
                                BY VALUE 0 0
                                GIVING STAT
          IF STAT IS FAILURE
          THEN
              CALL "LIB$STOP" USING BY VALUE STAT
          END-IF
          DISPLAY "System service call failed with error:"
          DISPLAY ERRMSG(1:MSGLEN)
*
*          This is where the handler would perform
*          corrective measures
*          .
*          .
*          .
*          MOVE SS$_CONTINUE TO SS_HAND
*
      END-IF.
      EXIT PROGRAM.
END PROGRAM SSSHAND.
```

## Using HP COBOL in the Alpha, I64, or VAX Common Language Environment

### 13.5 Establishing and Removing User Condition Handlers (OpenVMS)

To run this example program:

```
$ COBOL SSSCOND
$ LINK SSSCOND
$ RUN SSSCOND
```

System service call failed with error:

```
%SYSTEM-F-IVCHAN, invalid I/O channel
%SYSTEM-F-SSFAIL, system service failure exception, status=0000013C,
      PC=8005FA40, PS=0000001B
```

%TRACE-F-TRACEBACK, symbolic stack dump follows

Image Name	Module Name	Routine Name	Line Number	rel PC	abs PC
			0	8005FA40	8005FA40
SSCOND	SSCOND	SSCOND	21	000000CC	000300CC
SSCOND			0	00020470	00030470
			0	870C8170	870C8170
			0	849708F0	849708F0

For more information about condition handling, including LIB\$ESTABLISH and LIB\$REVERT, refer to the *OpenVMS RTL Library (LIB\$) Manual*. ♦

## 13.6 Examples (OpenVMS)

This section provides examples that demonstrate how to call system routines from COBOL programs.

Example 13–2 shows a procedure call and gives a sample run of the program RUNTIME. It calls MTH\$RANDOM, a random number generator from the Run-Time Library, and generates 10 random numbers. To obtain different random sequences on separate runs, change the value of data item SEED for each run.

### Example 13–2 Random Number Generator (OpenVMS)

```
IDENTIFICATION DIVISION.
PROGRAM-ID. RUNTIME.

*****
* This program calls MTH$RANDOM, a random number *
* generator from the Run-Time Library. *
*****

DATA DIVISION.
WORKING-STORAGE SECTION.
01 SEED PIC 9(5) COMP VALUE 967.
01 A-NUM COMP-1.
01 C-NUM PIC Z(5).
PROCEDURE DIVISION.
GET-RANDOM-NO.
    PERFORM 10 TIMES
        CALL "MTH$RANDOM" USING SEED GIVING A-NUM
        MULTIPLY A-NUM BY 100 GIVING C-NUM
        DISPLAY "Random Number is " C-NUM
    END-PERFORM.
```

Example 13–3 shows a program fragment that calls the SYS\$SETDDIR system service.

Example 13–4 calls the System Service routine \$ASCTIM.

## Using HP COBOL in the Alpha, I64, or VAX Common Language Environment

### 13.6 Examples (OpenVMS)

#### Example 13-3 Using the SYS\$SETDDIR System Service (OpenVMS)

```
01 DIRECTORY PIC X(24) VALUE "[MYACCOUNT.SUBDIRECTORY]".
01 STAT PIC S9(9) COMP.
.
.
.
CALL "SYS$SETDDIR" USING BY DESCRIPTOR DIRECTORY
                        OMITTED
                        OMITTED
                        GIVING STAT.
```

#### Example 13-4 Using \$ASCTIM (OpenVMS)

```
IDENTIFICATION DIVISION.
PROGRAM-ID.    CALLTIME.
*****
* This program calls the system service routine *
* $ASCTIM which converts binary time to an ASCII *
* string representation.                        *
*****
DATA DIVISION.
WORKING-STORAGE SECTION.
01 TIMLEN          PIC 9999  COMP VALUE 0.
01 D-TIMLEN       PIC 9999  VALUE 0.
01 TIMBUF         PIC X(24) VALUE SPACES.
01 RETURN-VALUE   PIC S9(9) COMP VALUE 999999999.
PROCEDURE DIVISION.
000-GET-TIME.
    DISPLAY "CALL SYS$ASCTIM".
    CALL "SYS$ASCTIM" USING BY REFERENCE TIMLEN
                        BY DESCRIPTOR TIMBUF
                        OMITTED
                        GIVING RETURN-VALUE.
    IF RETURN-VALUE IS SUCCESS
    THEN
        DISPLAY "DATE/TIME " TIMBUF
        MOVE TIMLEN TO D-TIMLEN
        DISPLAY "LENGTH OF RETURNED = " D-TIMLEN
    ELSE
        DISPLAY "ERROR".
    STOP RUN.
```

Example 13-5 shows output from a sample run of the CALLTIME program.

# Using HP COBOL in the Alpha, I64, or VAX Common Language Environment

## 13.6 Examples (OpenVMS)

### Example 13–5 Sample Run of CALLTIME (OpenVMS)

```
CALL SYSSASCTIM
DATE/TIME 11-AUG-2000 09:34:33.45
LENGTH OF RETURNED = 0023
```

The following example shows how to call the procedure that enables and disables detection of floating-point underflow (LIB\$FLT\_UNDER) from a COBOL program. The format of the LIB\$FLT\_UNDER procedure is explained in the *OpenVMS RTL Library (LIB\$) Manual*.

```
WORKING-STORAGE SECTION.
01  NEW-SET          PIC S9(9) USAGE IS COMP.
01  OLD-SET         PIC S9(9) USAGE IS COMP.
.
.
.
PROCEDURE DIVISION.
.
.
.
P0.
    MOVE 1 TO NEW-SET.
    CALL "LIB$FLT_UNDER" USING NEW-SET GIVING OLD-SET.
```

The following example shows how to call the procedure that finds the first clear bit in a given bit field (LIB\$FFC). This procedure returns a COMP longword condition value, represented in the example as RETURN-STATUS.

```
WORKING-STORAGE SECTION.
01  START-POS       PIC S9(9) USAGE IS COMP VALUE 0.
01  SIZ             PIC S9(9) USAGE IS COMP VALUE 32.
01  BITS           PIC S9(9) USAGE IS COMP VALUE 0.
01  POS            PIC S9(9) USAGE IS COMP VALUE 0.
01  RETURN-STATUS  PIC S9(9) USAGE IS COMP.
.
.
.
PROCEDURE DIVISION.
.
.
.
    CALL "LIB$FFC" USING START-POS,
                        SIZ,
                        BITS,
                        POS
                        GIVING RETURN-STATUS.

    IF RETURN-STATUS IS FAILURE
        THEN GO TO error-proc.
```

Example 13–6 uses LIB\$SET\_SYMBOL to set a value for a DCL symbol and shows the use of LIB\$K\_\* symbols for arguments and LIB\$\_\* symbols for return status values.

## Using HP COBOL in the Alpha, I64, or VAX Common Language Environment

### 13.6 Examples (OpenVMS)

#### Example 13–6 Using LIB\$K\_\* and LIB\$\_\* Symbols (OpenVMS)

```
identification division.
program-id. SETSYM.
environment division.

data division.
working-storage section.
01 LOCAL-SYM pic S9(9) comp value external LIB$K_CLI_LOCAL_SYM.
01 GLOBAL-SYM pic S9(9) comp value external LIB$K_CLI_GLOBAL_SYM.
01 COND-VAL pic S9(9) comp.
88 COND-NORMAL value external SS$ NORMAL.
88 COND-AMBSYMDEF value external LIB$_AMBSYMDEF.
procedure division.
1. call "LIB$SET_SYMBOL" using
    by descriptor "XSET*SYM"
    by descriptor "Test1A"
    by reference LOCAL-SYM
    giving COND-VAL.
    if COND-AMBSYMDEF display "Ambiguous"
    else if COND-NORMAL display "OK"
    else display "Not OK".
2. call "LIB$SET_SYMBOL" using
    by descriptor "XSETS"
    by descriptor "Test1B"
    by reference LOCAL-SYM
    giving COND-VAL.
    if COND-AMBSYMDEF display "Ambiguous"
    else if COND-NORMAL display "OK"
    else display "Not OK".
3. call "LIB$SET_SYMBOL" using
    by descriptor "XSETS"
    by descriptor "Test1C"
    by reference GLOBAL-SYM
    giving COND-VAL.
    if COND-AMBSYMDEF display "Ambiguous"
    else if COND-NORMAL display "OK"
    else display "Not OK".
9. stop run.
```

This uses the following macro, libdef.mar:

```
.TITLE libdef
$HLPDEF GLOBAL ; case sensitive!
.END
```

The program is compiled, linked, and run, as follows:

```
$ cobol setsym
$ macro libdef
$ link setsym,libdef
$ run setsym
OK
Ambiguous
OK
$ show symbol xset*
XSETS == "Test1C"
XSET*SYM = "Test1A"
```



---

## Using the REFORMAT Utility

The REFORMAT Utility converts source programs between terminal format and conventional ANSI format. Consider the two formats and their characteristics:

- Terminal format eliminates the line-number and identification fields of ANSI format and allows horizontal tab characters and short lines. It saves disk space and decreases compile time.
- Conventional ANSI format produces source programs compatible with the reference format as defined in the ANSI-85 COBOL Standard.

The *HP COBOL Reference Manual* describes both formats in detail.

On OpenVMS, REFORMAT is installed by the HP COBOL installation procedure (if you answered "yes" to the query during installation), and is placed in the following location:

```
SYS$SYSTEM:REFORMAT.EXE ◆
```

This chapter provides the following information about using the REFORMAT utility:

- Running the REFORMAT utility (Section 14.1)
- ANSI-to-terminal format conversion (Section 14.2)
- Terminal-to-ANSI format conversion (Section 14.3)
- REFORMAT error messages (Section 14.4)

### 14.1 Running the REFORMAT Utility

On OpenVMS, you can define REFORMAT as a foreign command as follows:

```
$ REFORMAT := "$SYS$SYSTEM:REFORMAT.EXE"
```

Then you would type the following command:

```
$ reformat ◆
```

On Tru64 UNIX, type the following:

```
% reformat ◆
```

The following example shows a typical session using the REFORMAT Utility (the command line prompt is omitted):

## Using the REFORMAT Utility

### 14.1 Running the REFORMAT Utility

```
REFORMAT -  
REFORMAT - Enter Y for ANSI-to-terminal conversion, or  
REFORMAT - Enter N (default) for terminal-to-ANSI conversion.  
REFORMAT - Enter ^Z to exit.  
REFORMAT - ANSI-to-terminal format conversion mode [ Y / [N] ]? n  
REFORMAT - Terminal-to-ANSI format selected  
REFORMAT - Terminal-format input file spec : myprog.cob  
REFORMAT - ANSI-format output file spec: myprog2.cob  
REFORMAT - Columns 73 to 80:  
REFORMAT - 42 Terminal source code records converted to ANSI format  
REFORMAT -  
REFORMAT - Enter Y for ANSI-to-terminal conversion, or  
REFORMAT - Enter N (default) for terminal-to-ANSI conversion.  
REFORMAT - Enter ^Z to exit.  
REFORMAT - ANSI-to-terminal format conversion mode [ Y / [N] ]? ^Z  
REFORMAT -
```

In the preceding example, the following events took place:

1. The user typed n in response to the first prompt, indicating a desire to convert a file from Terminal to ANSI format (the user could have simply pressed Return, as the default direction is Terminal-to-ANSI).
2. The user typed myprog.cob in response to the prompt for an input file spec.
3. The user typed myprog2.cob in response to the prompt for an output file spec.
4. The program next prompted for an identification entry in columns 73 to 80, and the user simply pressed Return.
5. Ending that dialog, the program reported that it converted 42 source code records.
6. The program then repeated the original prompts, to which the user replied with a Ctrl/Z.

The Ctrl/Z ends this reformatting session.

## 14.2 ANSI-to-Terminal Format Conversion

REFORMAT converts each ANSI format source line to terminal format by:

- Removing the 6-character sequence field in the first six character positions of the ANSI format line
- Moving any continuation symbol (-) or comment symbols (\* or /) from character position 7 into character position 1
- Moving the conditional compilation character (if any) from the ANSI format indicator area into character position 2 and inserting a backslash character (\) into character position 1 of the terminal format line
- Removing the identification entry field in character positions 73 to 80 of the ANSI format line
- Removing insignificant trailing spaces before character position 73 of the ANSI format line
- Replacing every form-feed record with a line containing a slash (/) in character position 1

- Placing the converted code in positions 1 to the end of the line, thereby creating a terminal format line

---

**Note**

---

When you convert programs that contain continued nonnumeric literals you should examine those literals to see if they require any changes. (This should occur only when going from ANSI format to terminal format.)

---

## 14.3 Terminal-to-ANSI Format Conversion

REFORMAT converts each terminal format source line to ANSI format by:

- Placing a 6-character line number (000010) in the first six character positions of the first line and increasing it by 000010 for each subsequent line.
- Moving any continuation symbol (-), or the comment symbols (\* or /) from character position 1 into character position 7.
- Removing the backslash character (\), if any, from character position 1 in terminal format and moving the following conditional compilation character into character position 7 of the ANSI format line.
- Replacing horizontal tabs with space characters at every eighth character position, starting at character position 5 and ending at the end of the line.
- Moving spaces into remaining character positions after the last character of code and before character position 73.
- Expanding a terminal line with more than 65 characters into two or more ANSI format lines and right-justifying these lines at character position 72.
- Placing either identification characters (if supplied at program initialization) or spaces into character positions 73 to 80.
- Right-justifying (at position 72) the first line of a continued nonnumeric literal. This ensures that the literal remains the same length as it was in the default format.
- Replacing every form-feed record with a line containing a slash (/) in position 7 and space characters in positions 8 to 72.
- Placing the converted code in character positions 8 to 72, thereby creating one or more ANSI format lines.

Note that it is possible to construct a terminal format line that converts to an invalid ANSI formatted line. Consider the case of a conditional compilation line with a long nonnumeric literal:

```
\A 01 ART PIC X(80) VALUE "A ... A".
```

This statement cannot be reformatted to a valid ANSI statement. The literal is 80 characters long, which indicates that the literal must be continued on the next line by placing a continuation symbol (-) in the indicator area. The line is also a conditional compilation line, which indicates that the A is to be placed in the indicator area. Clearly both characters cannot be placed in the indicator area. HP COBOL continues the conditional compilation line by placing the A in the indicator area. This means the program remains valid if conditionals are not used in the compilation because the lines become comment lines. If conditionals are used, you must locate and correct these invalid lines. The reformat program

## Using the REFORMAT Utility

### 14.3 Terminal-to-ANSI Format Conversion

is a text processor and does not perform the level of checking required by lines such as these. You detect this error during a compile operation.

### 14.4 REFORMAT Error Messages

If any of your responses to the prompts are incorrect, REFORMAT displays error messages. It replaces the parentheses and the parenthetical text with the appropriate format type you specified.

```
REFORMAT - Error in opening (ANSI or terminal) format input file:
REFORMAT -      (ANSI or terminal) format input file spec:
```

The system could not open the input file; either the file is not on the specified device or you typed the file name incorrectly.

The default device is SYS\$DISK on OpenVMS systems; it is stdin on Tru64 UNIX systems.

To continue processing, examine the input file specification and type a corrected version. To process another file, type a new input file specification. To end execution, type Ctrl/Z (on OpenVMS systems) or CTRL/D (on Tru64 UNIX systems).

```
REFORMAT - Error in opening (ANSI or terminal) format output file:
REFORMAT -      (ANSI or terminal) format output file spec:
```

The system could not open the output file. An incorrectly typed file specification usually causes this error.

The default device is SYS\$DISK on OpenVMS systems; it is ./ on Tru64 UNIX systems.

To continue, examine the output file specification and type a corrected version. To end execution, type Ctrl/Z (on OpenVMS systems) or CTRL/D (on Tru64 UNIX systems).

```
REFORMAT - (ANSI or terminal) format input file is empty
REFORMAT -      (ANSI or terminal) format input file spec:
```

The system opened an empty input file. To continue, type a new input file specification. To end execution, type Ctrl/Z (on OpenVMS systems) or CTRL/D (on Tru64 UNIX systems).

```
REFORMAT - Error in reading (ANSI or terminal) format input file
REFORMAT - Reformating aborted
REFORMAT - n (ANSI or terminal) COBOL source records converted to
              (ANSI or terminal) format
REFORMAT - ANSI-to-terminal format conversion mode [ Y or N ]?
```

REFORMAT failed to read a record from the input file. This error ends the conversion process. REFORMAT closes both files and displays the number of converted input records.

You can convert another file, or you can end the session by typing Ctrl/Z (on OpenVMS systems) or CTRL/D (on Tru64 UNIX systems).

```
REFORMAT - Error in writing (ANSI or terminal) format output file
REFORMAT - Reformating aborted
REFORMAT - n (ANSI or terminal) COBOL source records converted to
              (ANSI or terminal) format
REFORMAT - ANSI-to-terminal format conversion mode [ Y or N ]?
```

REFORMAT failed in an attempt to write an output record. It ends execution and closes both files.

## Using the REFORMAT Utility

### 14.4 REFORMAT Error Messages

To process another file, type a new input file specification and continue the prompting message sequence. To end execution, type Ctrl/Z (on OpenVMS systems) or CTRL/D (on Tru64 UNIX systems).



---

## Optimizing Your HP COBOL Program

You can specify optimization and data alignment on the COBOL compiler command line to improve run-time performance. You can also decrease processing time and save storage space by writing programs that take advantage of compiler optimizations.

The information that you find here contains guidelines only, not rules. Follow those suggestions that fit your needs.

This chapter provides the following information about optimizing your HP COBOL programs on the OpenVMS and Tru64 UNIX operating systems:

- Specifying optimization on the compiler command line (Alpha, I64) (Section 15.1)
- Specifying alignment of data for optimum performance (Alpha, I64) (Section 15.2)
- Using COMP data items for speed (Section 15.3)
- Other ways to improve the performance of operations on numeric data (Section 15.4)
- Choices in Procedure Division statements (Section 15.5)
- I/O operations (Section 15.6)
- Optimizing file design (Section 15.7)
- Optimizing image activation (Section 15.8)

### 15.1 Specifying Optimization on the Compiler Command Line (Alpha, I64)

The HP COBOL compiler is a highly optimizing compiler. Full optimization is the default with the COBOL compiler command and usually results in improved run-time performance. You can specify the desired level of optimization by adding a value to the optimize option. The various formats are provided here to illustrate the similarity in processes across the supported platforms.

On Alpha and I64 systems, the /OPTIMIZE qualifier has the following forms:

```
/OPTIMIZE[=LEVEL=n]
```

```
/OPTIMIZE=TUNE=keyword
```

or

```
/NOOPTIMIZE     ◆
```

## Optimizing Your HP COBOL Program

### 15.1 Specifying Optimization on the Compiler Command Line (Alpha, I64)

On Tru64 UNIX systems, the `-O` flag and the `-tune` flag specify optimization. The `-O` flag has the following form:

`-On`

The `-tune` flag has the following form:

`-tune keyword` ◆

The `-tune` flag is the equivalent of the `/OPTIMIZE=TUNE` qualifier.

`/OPTIMIZE=LEVEL` is the same on OpenVMS Alpha, OpenVMS I64, and Tru64 UNIX systems. *n* is a number ranging from 0 to 4, specifying the level of optimization. In brief, these levels mean the following:

- Level 0—Has the same effect as `/NOOPTIMIZE`. All optimizations are turned off, and the compiler does not check for unassigned variables.
- Level 1—Enables local optimizations, including instruction scheduling and recognition of common subexpressions.
- Level 2—Enables all level 1 optimizations, and adds some global optimizations (such as split lifetime analysis, code motion, strength reduction and test replacement, and code scheduling).
- Level 3—Enables all level 2 optimizations, and adds more global optimizations (such as decimal shadowing, integer multiplication and division expansion, using shifts, loop unrolling, and code replication to eliminate branches). All optimizations are turned on.
- Level 4—Is identical to level 3 for COBOL. This is the default if you specify optimize with no value, or if you compile without specifying any form of the optimize option on the command line.

`/OPTIMIZE=TUNE=keyword` (or `-tune keyword` specifies the kind of optimized code to be generated, allowing you to tune optimization to the specific Alpha hardware. The *keyword* can be any of the following:

- **GENERIC**—Generates and schedules code that will execute well for both generations (EV4 and EV5 and later) of Alpha processors. This is the default. This provides generally efficient code for those cases where both processor generations are likely to be used.
- **HOST**—Generates and schedules code optimized for the processor generation in use on the system being used for compilation.
- **EV4**—Generates and schedules code optimized for the 21064, 21064A, 21066, and 21068 implementations of the Alpha chip.
- **EV5**—Generates and schedules code optimized for the 21164 implementation of the Alpha chip. This processor generation is faster than EV4.
- **EV56**—Generates code for some 21164 chip implementations that use the byte and word manipulation instruction extensions of the Alpha architecture. Programs compiled with the EV56 keyword might incur run-time emulation overhead on EV4 and EV5 processors, but will still run correctly on OpenVMS Version 7.1 (or later) systems.
- **EV6**—Generates and schedules code for the 21264 chip implementation that uses the following extensions to the base Alpha instruction set: **BWX** (Byte/Word manipulation) and **MAX** (Multimedia) instructions, square root and **FIX** (Floating-point convert) instructions.



## 15.1 Specifying Optimization on the Compiler Command Line (Alpha, I64)

- **EV67**—Generates and schedules code for the 21264A chip implementation that uses the following extensions to the base Alpha instruction set: **BWX** (Byte/Word manipulation) and **MAX** (Multimedia) instructions, square root and **FIX** (Floating-point convert) instructions, and **CIX** (Count) instructions.
- **EV68**—Generates and schedules code that uses the following extensions to the base Alpha instruction set: **BWX** (Byte/Word manipulation) and **MAX** (Multimedia) instructions, square root and **FIX** (Floating-point convert) instructions, and **CIX** (Count) instructions.
- **PCA56**—Generates code for the 21164PC chip implementation that uses the byte and word manipulation instruction extensions and multimedia instruction extensions of the Alpha architecture.

Programs compiled with the **PCA56** keyword might incur run-time emulation overhead on **EV4**, **EV5**, and **EV56** processors, but will still run correctly on OpenVMS Version 7.1 (or later) systems.

- The **/OPTIMIZE=TUNE** qualifier is currently ignored on OpenVMS I64.

### **/ARCHITECTURE** Qualifier

The **/ARCHITECTURE=option** qualifier (or **-arch** option on Tru64 UNIX) determines the type of Alpha chip code that will be generated for a particular program.

The **/ARCHITECTURE** qualifier uses the same options (keywords) as the **/OPTIMIZE=TUNE** qualifier, and their definitions are similar. However, their effects are not identical. The **/OPTIMIZE=TUNE** qualifier is primarily used by certain higher-level optimizations for instruction scheduling purposes, while the **/ARCHITECTURE** qualifier determines the type of code instructions generated for the program unit being compiled.

OpenVMS Version 7.1 and subsequent releases provide an operating system kernel that includes an instruction emulator. This emulator allows new instructions, not implemented on the host processor chip, to execute and produce correct results. All Alpha processors implement a core set of instructions. Certain Alpha processor versions include additional instruction extensions. Applications using emulated instructions will run correctly, but might incur significant software emulation overhead at run time.

The following **/ARCHITECTURE** options are supported:

- **GENERIC**—Generates code that is appropriate for all Alpha processor generations. This is the default.

Programs compiled with the **GENERIC** option run all implementations of the Alpha architecture without any instruction emulation overhead.

- **HOST**—Generates code for the processor generation in use on the system being used for compilation.

Programs compiled with this option on other implementations of the Alpha architecture may encounter instruction emulation overhead.

- **EV4**—Generates code for the 21064, 21064A, 21066, and 21068 implementations of the Alpha architecture.

Programs compiled with the **EV4** option run without instruction emulation overhead on all Alpha processors.

- **EV5**—Generates code for some 21164 chip implementations of the Alpha architecture that use only the base set of Alpha instructions (no extensions).

## Optimizing Your HP COBOL Program

### 15.1 Specifying Optimization on the Compiler Command Line (Alpha, I64)

Programs compiled with the EV5 option run without instruction emulation overhead on all Alpha processors.

- EV56—Generates code for some 21164 chip implementations that use the byte and word manipulation instruction extensions of the Alpha architecture.

Programs compiled with the EV56 option may incur emulation overhead on EV4 and EV5 processors, but will still run correctly on OpenVMS Version 7.1 (or later) systems.

- EV6—Generates code for the 21264 chip implementation that uses the following extensions to the base Alpha instruction set: BWX (Byte/Word manipulation) and MAX (Multimedia) instructions, square root and FIX (Floating-point convert) instructions.

Programs compiled with the EV6 option may incur emulation overhead on EV4, EV5, EV56, and PCA56 processors, but will still run correctly on OpenVMS Version 7.1 (or later) systems.

- EV67—Generates code for the 21264A chip implementation that uses the following extensions to the base Alpha instruction set: BWX (Byte/Word manipulation) and MAX (Multimedia) instructions, square root and FIX (Floating-point convert) instructions, and CIX (Count) instructions.

Programs compiled with the EV67 option may incur emulation overhead on EV4, EV5, EV56, EV6, and PCA56 processors, but will still run correctly on OpenVMS Version 7.1 (or later) systems.

- EV68—Generates code that uses the following extensions to the base Alpha instruction set: BWX (Byte/Word manipulation) and MAX (Multimedia) instructions, square root and FIX (Floating-point convert) instructions, and CIX (Count) instructions.

Programs compiled with the EV68 option may incur emulation overhead on EV4, EV5, EV56, EV6, EV7, and PCA56 processors, but will still run correctly on OpenVMS Version 7.1 (or later) systems.

- PCA56—Generates code for the 21164PC chip implementation that uses the byte and word manipulation instruction extensions and multimedia instruction extensions of the Alpha architecture.

Programs compiled with the PCA56 option may incur emulation overhead on EV4, EV5, and EV56 processors, but still run correctly on OpenVMS Version 7.1 (or later) systems.

- The /ARCHITECTURE qualifier is currently ignored on OpenVMS I64.

---

#### Note

---

If a program contains declarations of non-EXTERNAL variables that are not referenced in the program, the HP COBOL compiler does not allocate those variables. These variables are not affected by /OPTIMIZE; they simply are not allocated. This feature improves both resource usage and run-time performance, and allows the use of site “copybooks” that have numerous standardized variables. Only those copybook variables that are referenced will be allocated within a given program.

---

## 15.1 Specifying Optimization on the Compiler Command Line (Alpha, I64)

### Optimization and Debugging

You should disable optimization when you compile a program for debugging. Optimizations can cause unexpected and confusing behavior in a debugging session by changing the order of machine code. When you turn optimization off, a debugging session is expedited and simplified because the machine code is put in the same order as the lines in your source program.

On the Tru64 UNIX operating system, full optimization, corresponding to the `-O4` or `-O` flag, is the default *unless* you specify the `-g` flag on the command line for debugging. The `-g` flag disables optimization entirely, and displays this message:

```
cobol: Warning: . . . File not optimized; use -g3 if both
optimization and debugging wanted      ◆
```

On OpenVMS Alpha systems, in general, specify `/NOOPTIMIZE` if you specify `/DEBUG` when you compile a program. If you specify `/DEBUG` but omit any form of the `/OPTIMIZE` qualifier on the command line, the compiler issues the following informational message:

```
%COBOL-I-DEBUGOPT, /NOOPTIMIZE is recommended with /DEBUG
```

Unlike other informational messages, which are turned off by default, this message is issued even if `/WARNINGS=NOINFORMATION` is in effect. You can turn it off by specifying any form of the `/OPTIMIZE` qualifier.

If you need to debug optimized code, refer to the *OpenVMS Debugger Manual*. ◆

### Other Effects of Optimization

An effect of optimization is larger object modules and longer compile times. These potential disadvantages are typically outweighed by faster run times.

To speed compilations during program development, you may want to compile with the `noobject` option when you want to check syntax.

When checking for correct execution, you may want to compile initially with no optimization, and later with optimization when the program is executing correctly.

If your program is not executing correctly and you suspect an optimization-related problem, try compiling it with no optimization or with level 2 optimization. The latter is a compromise that can often help, because it turns off some of the more aggressive optimizations, such as decimal shadowing.

## 15.2 Specifying Alignment of Data for Optimum Performance (Alpha, I64)

Proper alignment of numeric data items within record structures can make run-time performance significantly faster. See Chapter 16 for information on data alignment specified on the compiler command line, and information on compiler directives that specify alignment. Refer to the *HP COBOL Reference Manual* for information on the `SYNCHRONIZED` clause, which is also used to specify alignment. ◆

## 15.3 Using COMP Data Items for Speed

Large, compute-intensive applications can often run faster if arithmetic data items are USAGE COMP.<sup>3</sup> As you write COBOL code, maximize your use of COMP for arithmetic operands. COMP data items typically run faster for arithmetic operations than PACKED-DECIMAL (COMP-3) or DISPLAY data items. In general, the following guidelines hold true:

- When the data item is part of an arithmetic operation, specify USAGE IS COMP.
- When the data item is used as a subscript, specify USAGE IS INDEX.

For existing COBOL programs, you should consider converting numeric data items to COMP if an application is compute-bound and time-critical and you would like to improve execution speed. Some factors in the decision whether to convert are discussed in this section.

### Precision Not Reduced by Conversion to COMP

The data types usually employed for COBOL data items are summarized below:

Usage	Data Type
COMP, BINARY, COMP-5, COMP-X	Binary
COMP-1	F-Float (compiled with /FLOAT=D_FLOAT or /FLOAT=G_FLOAT)
	S-Float (compiled with /FLOAT=IEEE_FLOAT)
COMP-2	D-Float (compiled with /FLOAT=D_FLOAT)
	G-Float (compiled with /FLOAT=G_FLOAT)
	T-Float (compiled with /FLOAT=IEEE_FLOAT)
COMP-3, PACKED-DECIMAL	Packed-decimal
DISPLAY	Text or decimal

On Tru64 UNIX systems, the F\_FLOAT, D\_FLOAT and G\_FLOAT data types are not supported. ♦

Operations on COMP-1 and COMP-2 data items are fast. However, it is *not* recommended that you convert data items to COMP-1 or COMP-2, because you could lose precision. Floating-point numbers are approximations using a scientific notation relative to powers of two. A COMP-1 operand gives approximately 7 decimal digits of precision, a COMP-2 approximately 15; either often represents a value less precisely than the other data types, which are fixed point.

The semantics of COMP (BINARY, COMP-5, COMP-X), COMP-3 (PACKED-DECIMAL), and DISPLAY operands are the same: each can be scaled (except for COMP-5 and COMP-X) and signed, and can hold up to 18 decimal digits. Therefore, converting existing programs from COMP-3 or DISPLAY to COMP will yield results that are no less accurate or precise. The only effect on operands

<sup>3</sup> Following are some reasons: COMP data items can be manipulated by direct and natural use of the Alpha instruction set. Manipulation of decimal types requires longer sequences of instructions, most of which are implemented as HP COBOL Run-Time Library routines. While floating point is also a natural Alpha data type, it does not support the full 18-digit precision allowed in COBOL. For more information, refer to the *HP COBOL Reference Manual*.

## Optimizing Your HP COBOL Program

### 15.3 Using COMP Data Items for Speed

is the method of storage; and the primary effect on operations is improved performance.

Because changing the data type changes the way data is stored, you may not be able to change the data type of items that participate in a REDEFINES or that are elements of file record structures.

#### Tools That Can Help You Decide Whether to Convert a Program

Hewlett-Packard does not recommend a massive conversion of all source programs to use COMP operands. Most existing COBOL programs perform very well, and conversions of old programs can be expensive. The following tools can help you decide which programs would run significantly faster if converted, and to discover program interdependencies:

#### PCA

On OpenVMS, the Performance and Coverage Analyzer (PCA) can target specific areas of programs that require large amounts of CPU time. If 80 percent of the processing time is used by 20 percent of the COBOL routines, you may benefit from converting only these routines to use COMP.

#### SCA and LSE

The Source Code Analyzer (SCA) can help discover program interdependencies as you contemplate changes. For example, if it is proposed that an item declared COMP-3 be changed, SCA can quickly and easily find all the references to that item.

If SCA is used in conjunction with the Language-Sensitive Editor (LSE), LSE can bring up buffers in your editing session with each of the references.

#### Oracle CDD/Repository

The Common Data Dictionary can store data definitions and dependency information, which can then be maintained from one centralized location. ♦

#### prof, pixie

On Tru64 UNIX, these performance analysis tools can be used to identify programs (prof) or sections of programs (pixie) that require large amounts of CPU time. If 80 percent of the processing time is used by 20 percent of the COBOL routines, you may benefit from converting only these routines to use COMP. ♦

## 15.4 Other Ways to Improve the Performance of Operations on Numeric Data

In addition to using COMP data items whenever possible for arithmetic operations in programs, there are other ways to improve performance through the choice of numeric data types, as discussed in this section.

### 15.4.1 Mixing Scale Factors and Data Types

Scaling is the process of aligning decimal points for numeric data items. Where possible, avoid mixing different scale-factors and data types in arithmetic operations.

In general, type conversions can be minimized by using operands of the same usage. Scaling operations can be minimized by using compatible scale factors according to the operation. For example, for add and subtract, all operands should have the same number of fractional digits; for multiply, the number of

## Optimizing Your HP COBOL Program

### 15.4 Other Ways to Improve the Performance of Operations on Numeric Data

fractional digits in the result should be the same as the sum of the number of fractional digits in the other two operands.

#### 15.4.2 Limiting Significant Digits

In general, the fewer significant digits in an item, the better the performance (except as described in Section 15.4.1). For example, for a numeric data item to contain a number from 1 to 999, declare it as PIC 9(3), not PIC 9(10). This will also save storage.

#### 15.4.3 Reducing the Complexity of Arithmetic Expressions

When the compiler evaluates an arithmetic expression, it must create intermediate data items to store the cumulative results of the successive arithmetic operations in the expression. Such intermediate data items have PICTUREs large enough to hold the largest and smallest possible intermediate resulting values for the particular arithmetic operation and the data items upon which it operates. In general, the more complex the arithmetic expression, the larger each successive intermediate data item's PICTURE grows. In particular, if a divide or exponentiation operation is not the last or only arithmetic operation in the expression, the corresponding intermediate data item and subsequent intermediate data items will have very large PICTUREs, which will adversely affect performance.

If you can break complex arithmetic expressions into two or more simpler expressions, performance can be greatly improved. Try to break expressions to make any divide or exponentiation operation the last operation in the subexpression. Store the results of each subexpression in data items you declare, and ensure that such data items have PICTUREs just sufficient to hold the expected partial results.

#### 15.4.4 Selection of Data Types (OpenVMS)

The Alpha architecture provides a full set of arithmetic operations for G-FLOAT. When your program operates upon G-FLOAT data items, the arithmetic operations are carried out at maximum native speed and with full precision. When D-FLOAT data types are encountered in your program source the HP COBOL compiler must perform a conversion to G-FLOAT. Similarly, data returned from an arithmetic

While these operations are actually transparent to you, there is a cost in both performance and accuracy, as some data can be lost in the two conversions.

HP COBOL supports different floating-point data types on each platform it supports, as summarized below:

Platform	Supported Floating-Point Data Types
OpenVMS Alpha	F-FLOAT, D-FLOAT, G-FLOAT, S-FLOAT, T-FLOAT
OpenVMS I64	F-FLOAT, D-FLOAT, G-FLOAT, S-FLOAT, T-FLOAT
OpenVMS VAX	F-FLOAT, D-FLOAT
Tru64 UNIX	S-FLOAT, T-FLOAT

The OpenVMS VAX floating-point implementation on OpenVMS Alpha is not totally compatible with the VAX floating-point implementation on VAX. Similarly, the OpenVMS VAX floating-point implementation on OpenVMS I64 is not totally compatible with the VAX floating-point implementations on either VAX or Alpha.

## 15.4 Other Ways to Improve the Performance of Operations on Numeric Data

In general, you should use the floating-point data types that are appropriate to your particular applications. In some cases, you have data in files based on a particular floating-point data type. In other cases, you are sharing floating-point data with modules written in other languages and the choice of which floating-point data type to use is dictated by the application's call interface.

If you are planning to use floating-point data where you are not already constrained by the application, it may make sense for you to use the specified defaults for each platform. Since all languages, including COBOL, have different defaults on different platforms, take this into account when deploying applications across multiple platforms.

For more information on floating-point arithmetic on the OpenVMS I64 operating system, see the whitepaper at:

[http://www.hp.com/products1/evolution/alpha\\_retaintrust/download/i64-floating-pt-wp.pdf](http://www.hp.com/products1/evolution/alpha_retaintrust/download/i64-floating-pt-wp.pdf)

## 15.5 Choices in Procedure Division Statements

Some Procedure Division statements make better use of the HP COBOL compiler than others. This section describes these statements and shows how to use them.

### 15.5.1 Using Indexing Instead of Subscripting

Using index names for table handling is generally more efficient than using PACKED-DECIMAL or numeric DISPLAY subscripts, since the compiler declares index names as binary data items. Subscript data items described in the Working-Storage Section as binary items are as efficient as index items. Indexing also provides more flexibility in table-handling operations, since it allows you to use the SEARCH statement for sequential and binary searches.

The following two examples are equally efficient:

#### Example 1

```
WORKING-STORAGE SECTION.
01 TABLE-SIZE.
   03 FILLER                                PIC X(300).
01 THE-TABLE REDEFINES TABLE-SIZE.
   03 TABLE-ENTRY OCCURS 30 TIMES PIC X(10).
01 SUB1          PIC S9(5) BINARY VALUE ZEROES.
```

#### Example 2

```
WORKING-STORAGE SECTION.
01 TABLE-SIZE.
   03 FILLER                                PIC X(300).
01 THE-TABLE REDEFINES TABLE-SIZE.
   03 TABLE-ENTRY OCCURS 30 TIMES PIC X(10)
      INDEXED BY IND-1.
```

### 15.5.2 Using SEARCH ALL Instead of SEARCH

When performing table look-up operations, SEARCH ALL, a binary search operation, is usually faster than SEARCH, a sequential search operation. However, SEARCH ALL requires the table to be in ascending or descending order by search key, while SEARCH imposes no restrictions on table organization. Also, with SEARCH ALL there should be unique key values in the table. Before using SEARCH ALL, you must pre-sort the table. If the table is not sorted, SEARCH ALL often gives incorrect results.

## Optimizing Your HP COBOL Program

### 15.5 Choices in Procedure Division Statements

The SORT statement (Format 2, which is an HP extension) can be used to sort an entire table. This is particularly useful in connection with SEARCH ALL. Refer to the SORT statement description in the Procedure Division chapter of the *HP COBOL Reference Manual* for the syntax and examples.

A binary search (SEARCH ALL) determines a table's size, finds the median table entry, and searches the table in sections, by using compare processes. A sequential search (SEARCH) manipulates the contents of an index to search the table sequentially. Section 4.3.8 contains examples of binary and sequential table-handling operations.

SEARCH ALL is supported for the EBCDIC as well as the ASCII collating sequence, on both VAX and Alpha.

#### 15.5.3 Selecting Hypersort or SORT-32 for Sorting Tasks

Hypersort is a high-performance sorting tool. COBOL has Hypersort on both Alpha platforms: OpenVMS and Tru64 UNIX.

On Tru64 UNIX, Hypersort is the only method. ♦

On OpenVMS Alpha, a different sorting method, SORT-32, is the default, but you can choose Hypersort instead for both sorting within COBOL and sorting at the DCL level. Refer to the DCL online help (type \$HELP SORT) for details on the differences between the two sorting methods and instructions for switching between methods. ♦

On OpenVMS VAX, only SORT-32 is available. ♦

#### 15.5.4 Minimizing USE Procedures with LINKAGE SECTION References

HP COBOL can perform certain optimizations if a program unit does not contain USE procedures that reference LINKAGE SECTION items. Note that USE procedures implicitly reference the following variables for any files associated with the USE procedures:

FILE STATUS  
DEPENDING ON  
RELATIVE KEY  
LINAGE-COUNTER  
Record buffer

If you need to reference LINKAGE SECTION items in a USE procedure, try to limit the size of the program unit containing that USE procedure. HP COBOL will be able to perform more aggressive optimizations on all the other program units that do not contain the LINKAGE SECTION references in any USE procedures.

## 15.6 I/O Operations

HP COBOL provides methods of controlling actions taken by the I/O system during I/O operations. You have the choice of accepting the defaults the I/O system provides or using these optional methods to make your program more efficient.

The HP COBOL language elements that can specify alternatives to the I/O system defaults are as follows:

- The APPLY clause in the I-O-CONTROL paragraph
- The RESERVE n AREAS clause in the FILE-CONTROL paragraph



- The SAME RECORD AREA clause in the I-O-CONTROL paragraph
- The BLOCK CONTAINS clause in the FD entry

On OpenVMS, for additional information on the RMS terms and concepts included in this section, refer to the *OpenVMS Record Management Utilities Reference Manual* and the *OpenVMS Record Management Services Reference Manual*.

### 15.6.1 Using the APPLY Clause

On OpenVMS, the APPLY clause in the I-O-CONTROL paragraph of the Environment Division provides phrases that you can use to improve I/O processing. ♦

On Tru64 UNIX systems, many elements of the I-O-CONTROL paragraph are for documentation only (accepted and ignored by the compiler), including the phrases described in this section. ♦

For complete information on the APPLY clause and its phrases, refer to the I-O-CONTROL section of the Environment Division chapter in the *HP COBOL Reference Manual*.

#### 15.6.1.1 Using the PREALLOCATION Phrase of the APPLY Clause (OpenVMS)

By default, the system does not preallocate disk blocks. As a result, files can require multiple extensions of disk blocks. Although file extension is transparent to your program, it can reduce performance. To avoid a degradation in performance, use the APPLY PREALLOCATION clause to preallocate disk blocks.

Specifying APPLY PREALLOCATION preallocates noncontiguous disk blocks. When you specify the CONTIGUOUS-BEST-TRY phrase, the I/O system makes up to three attempts to allocate as many contiguous disk blocks as it can; it then preallocates remaining blocks noncontiguously. The CONTIGUOUS-BEST-TRY phrase minimizes disk space fragmentation and gives better system throughput than CONTIGUOUS.

The APPLY CONTIGUOUS (physically adjacent) clause makes one attempt at contiguous preallocation; if it fails, the OPEN operation fails. Use APPLY CONTIGUOUS if you require contiguous physical space on disk.

Contiguous files can reduce or eliminate window turning. When you access a file, the file system maps virtual block numbers to logical block numbers. This map is a window to the file. It contains one pointer for each file extent. The file system cannot map a large noncontiguous file: the file system may have to turn the window to access records in another extent. However, a contiguous file is one extent. It needs one map pointer only, and window turning does not take place after you open the file.

The following statements create a file (after OPEN/WRITE) and preallocate 150 contiguous blocks:

## Optimizing Your HP COBOL Program

### 15.6 I/O Operations

```
ENVIRONMENT DIVISION.  
FILE-CONTROL.  
    SELECT A-FILE ASSIGN TO "MYFILE".  
    .  
    .  
I-O-CONTROL.  
    APPLY CONTIGUOUS PREALLOCATION 150 ON A-FILE.  
    .  
    .
```

#### 15.6.1.2 Using the EXTENSION Phrase of the APPLY Clause (OpenVMS)

The format of APPLY EXTENSION is as follows:

APPLY EXTENSION extend-amt ON { file-name } ...

The APPLY EXTENSION clause is another way to reduce I/O allocation and extension time. Adding records to a file whose current extent is full causes the file system to extend the file by one disk cluster. (A disk cluster is a set of contiguous blocks; its size is determined when you initialize the volume with the DCL INITIALIZE command or when the volume is mounted with the DCL MOUNT qualifier: /EXTENSION=n.)

You can override the default extension by specifying the number of blocks in the APPLY EXTENSION clause. The APPLY EXTENSION integer becomes a file attribute stored with the file.

#### 15.6.1.3 Using the DEFERRED-WRITE Phrase of the APPLY Clause (OpenVMS)

The format of APPLY DEFERRED-WRITE is as follows:

APPLY DEFERRED-WRITE ON { file-name } ...

Each WRITE or REWRITE statement can cause an I/O operation. The APPLY DEFERRED-WRITE clause permits writes to a file only when the buffer is full. Reducing the number of WRITE operations reduces file access time. However, the APPLY DEFERRED-WRITE clause can affect file integrity: records in the I/O buffer are not written to the file if the system crashes or the program aborts. DEFERRED-WRITE is very useful on write-shared files.

#### 15.6.1.4 Using the FILL-SIZE ON Phrase of the APPLY Clause (OpenVMS)

The format of APPLY FILL-SIZE is as follows:

APPLY FILL-SIZE ON { file-name } ...

Use the APPLY FILL-SIZE clause to populate (load) the file and force the HP COBOL compiler to write records into the bucket area not reserved by the fill number. Routine record insertion uses the fill space, thereby reducing bucket splitting and the resulting overhead.

Do not use the APPLY FILL-SIZE clause for routine record insertion; it prohibits the use of bucket fill space and creates unnecessary buckets.

#### 15.6.1.5 Using the WINDOW Phrase of the APPLY Clause (OpenVMS)

The format of APPLY WINDOW is as follows:

```
APPLY WINDOW ON { file-name } ...
```

Window size is the number of file mapping pointers stored in memory. A large window improves I/O because the system spends less time remapping the file.

When a disk is initialized, the default window size is set by specifying the /WINDOW qualifier. You can override this qualifier with the APPLY WINDOW clause. However, avoid specifying too large a window size. Window size is part of the system's pool space, and a large window size could affect system performance.

◆

#### 15.6.2 Using Multiple Buffers

Multibuffering can increase the speed of I/O operations by reducing the number of file accesses. When a program accesses a record already in the I/O buffer, the system moves the record to the current record area without executing an I/O operation.

You can specify multiple buffering by using the RESERVE clause in the SELECT statement of the Environment Division. The RESERVE clause specification overrides the system default. (The system default is usually set by means of the DCL SET RMS\_DEFAULT command.) The following example reserves six areas for FILE-A:

```
SELECT FILE-A ASSIGN TO "FILE-A"  
RESERVE 6 AREAS.
```

You can specify up to 127 areas in the RESERVE clause. In general, specifying from 2 to 10 areas is best.

#### 15.6.3 Sharing Record Areas

The compiler allocates unique storage space in the Data Division for each file's current record area. Transferring records between files requires an intermediate buffer area and adds to a program's processing requirements.

To reduce address space and processing overhead, files can share current record areas. Specify the SAME RECORD AREA clause in the I-O-CONTROL paragraph of the Environment Division. Records need not be the same size, nor must the maximum size of each current record area be the same.

Figure 15-1 shows the effect of current record area sharing in a program that reads records from one file and writes them to another. However, it also shows a drawback: current record area sharing is equivalent to implicit redefinition. The records do not exist separately. Therefore, if the program changes a record defined for the output file, the input file record is no longer available.

# Optimizing Your HP COBOL Program

## 15.6 I/O Operations

Figure 15-1 Sharing Record Areas

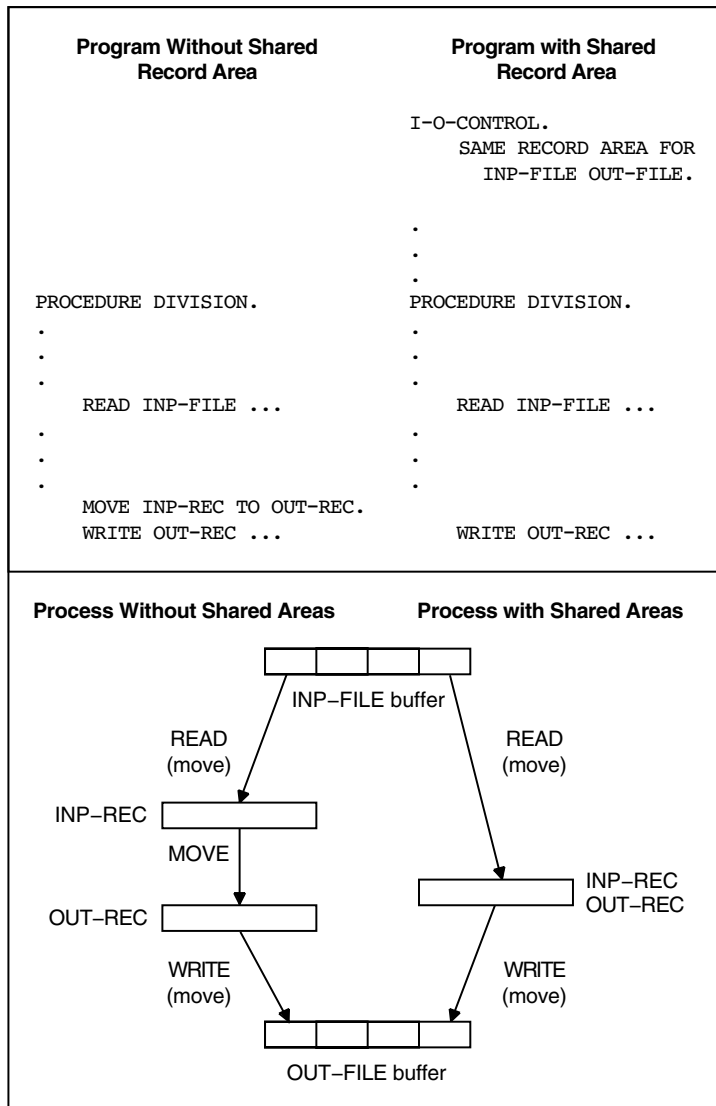

ZK-1539-GE

### 15.6.4 Using COMP Unsigned Longword Integers

The compiler generates the most efficient code to process the following clauses if a COMP unsigned longword integer (that is, PIC 9(9) COMP) is used in those cases where a variable is needed:

```
RELATIVE KEY  
DEPENDING ON  
LINAGE IS  
WITH FOOTING AT  
LINES AT TOP  
LINES AT BOTTOM  
ADVANCING LINES
```

## 15.7 Optimizing File Design (OpenVMS)

This section provides information on how to optimize the following file types:

- Sequential
- Relative
- Indexed

For a full discussion of file types, see Chapter 6.

### 15.7.1 Sequential Files

Sequential files have the simplest structure and the fewest options for definition, population, and handling. You can reduce the number of disk accesses by minimizing record length.

With a sequential disk file, you can use multiblocking to access a buffer area larger than the default. Because the system transfers disk data in 512-byte blocks, a blocking factor with a multiple of 512 bytes improves I/O access time. In the following example, the multiblock count (four) causes reads and writes to FILE-A to access a buffer area of four physical blocks:

```
FILE SECTION.  
FD FILE-A  
   BLOCK CONTAINS 2048 CHARACTERS  
   .  
   .  
   .
```

If you do not want to calculate the buffer size, but want to specify the number of records in each buffer, use the BLOCK CONTAINS n RECORDS clause. The following example specifies a buffer large enough to hold 15 records:

```
BLOCK CONTAINS 15 RECORDS
```

When using the BLOCK CONTAINS n RECORDS clause for sequential files on disk, RMS calculates the buffer size by using the maximum record unit size and rounding up to a multiple of 512 bytes. Consequently, the buffer could hold more records than you specify.

In the following example, the BLOCK CONTAINS clause specifies five records. RMS calculates the block size as eight records, or 512 bytes.

## Optimizing Your HP COBOL Program

### 15.7 Optimizing File Design (OpenVMS)

```
FILE SECTION.  
FD FILE-A  
   BLOCK CONTAINS 5 RECORDS.  
01 FILE-A-REC      PIC X(64).  
   .  
   .  
   .
```

By contrast, for magnetic tape, the program code entirely controls blocking. Hence, efficiency of the program and the file depends on the programmer's care with magnetic-tape blocking.

#### 15.7.2 Relative Files

I/O optimization of a relative file depends on four concepts:

- Maximum record number—The highest numbered record written to a relative file.
- Cell size—The unit of disk space needed to store a record unit size (record unit size = record + record overhead).
- Bucket size—The number of blocks read or written in one I/O operation (equivalent to buffer size). A bucket contains from 1 to 63 physical blocks.
- File size—The number of blocks used to preallocate the file.

##### 15.7.2.1 Maximum Record Number (MRN)

If you create a relative file with an HP COBOL program, the system sets the maximum record number (MRN) to 0, allowing the file to expand to any size.

If you create a relative file with the CREATE/FDL Utility, select a realistic MRN, since an attempt to insert a record with a number higher than the MRN will fail.

##### 15.7.2.2 Cell Size

The system calculates cell size. (However, you can specify a different cell size when you create the file by using the RECORD CONTAINS clause in the file description.) You cannot write records larger than the specified cell size.

Avoid selecting a cell size larger than necessary since this wastes disk space. To optimize the packing of cells into buckets, cell size should be evenly divisible into bucket size.

The system calculates cell size using these formulas:

Fixed-length records:            cell size = 1 + record size

Variable-length records:        cell size = 3 + record size

For fixed-length records, the overhead byte is a record deletion indicator. Variable-length records use two additional overhead bytes to indicate record length. The following example calculates a cell size of 101 for fixed-length records:

```
FD A-FILE  
   RECORD CONTAINS 100 CHARACTERS  
   .  
   .  
   .
```

### 15.7.2.3 Bucket Size

A bucket's size is from 1 to 63 blocks. A large bucket improves sequential access to a relative file. You can prevent wasted space between the last cell and the end of a bucket by specifying a bucket size that is a multiple of cell size.

If you omit the BLOCK CONTAINS clause, the system calculates a bucket size large enough to hold at least one cell or 512 bytes, whichever is larger (that is, large enough to hold a record and its overhead bytes). Records cannot cross bucket boundaries, although they can cross block boundaries.

Use the BLOCK CONTAINS n CHARACTERS clause of the file description to set your own bucket size (in bytes per bucket). Consider the following example:

```
FILE-CONTROL.  
  SELECT A-FILE  
    ORGANIZATION IS RELATIVE.  
  .  
  .  
  .  
DATA DIVISION.  
FILE SECTION.  
FD  A-FILE  
   RECORD CONTAINS 60 CHARACTERS  
   BLOCK CONTAINS 1536 CHARACTERS  
  .  
  .  
  .
```

In the preceding example, the bucket size is 3 blocks. Each bucket contains:

25 records (25 x 60)	= 1500 bytes
1 overhead byte per record (1 x 25)	= 25 bytes
11 bytes of wasted space	= <u>11 bytes</u>
TOTAL	= 1536 bytes

If you use the BLOCK CONTAINS CHARACTERS clause and specify a value that is not a multiple of 512, the I/O system rounds the value to the next higher multiple of 512.

In the following example, the BLOCK CONTAINS clause specifies one record per bucket. Because the cell needs only 61 bytes, there are 451 wasted bytes in each bucket.

```
FILE-CONTROL.  
  SELECT B-FILE  
    ORGANIZATION IS RELATIVE.  
  .  
  .  
  .  
DATA DIVISION.  
FILE SECTION.  
FD  A-FILE  
   RECORD CONTAINS 60 CHARACTERS  
   BLOCK CONTAINS 1 RECORD.  
  .  
  .  
  .
```

## Optimizing Your HP COBOL Program

### 15.7 Optimizing File Design (OpenVMS)

To improve I/O access time: (1) specify a small bucket size, and (2) use the BLOCK CONTAINS n RECORDS clause to specify the number of records (cells) in each bucket. This example creates buckets that contain eight records.

```
FD  A-FILE
    RECORD CONTAINS 60 CHARACTERS
    BLOCK CONTAINS 8 RECORDS.
    .
    .
    .
```

In the preceding example, the bucket size is one 512-byte block. Each bucket contains:

8 records (8 x 60)	= 480 bytes
1 overhead byte per record (1 x 8)	= 8 bytes
24 bytes of wasted space	<u>= 24 bytes</u>
<b>TOTAL</b>	<b>= 512 bytes</b>

#### 15.7.2.4 File Size

Calculating a file's size helps you determine its space requirements. A file's size is a function of its bucket size. When you create a relative file, use the following calculations to determine the number of blocks that you need, rounding up the result in each case:

$$\text{file size (in blocks)} = \frac{511 + (\text{number of buckets} * \text{bytes per bucket})}{512}$$

$$\text{number of buckets} = \frac{\text{number of records in the file}}{\text{number of cells per bucket}}$$

Assume that you want to create a relative file able to hold 3,000 records. The records are 255 bytes long (plus 1 byte per record for overhead), with 4 cells to a bucket (BLOCK CONTAINS 4 RECORDS). To determine file size:

1. Calculate the number of buckets:

$$750 = \frac{3000}{4}$$

2. Calculate bucket size (see Section 15.7.2.3)

$$2 = \frac{4 * (1 + 255)}{512}$$

3. Calculate bytes per bucket = (bucket size \* number of bytes in a block):

$$1024 = 2 * 512$$

4. Calculate file size:

$$1500 = \frac{511 + (750 * 1024)}{512}$$

*file size = 1500 physical blocks*

To allocate the 1500 calculated blocks to populate the entire file, use the APPLY CONTIGUOUS-BEST-TRY PREALLOCATION clause; otherwise, allocate fewer blocks.

Before writing a record to a relative file, the I/O system must have formatted all buckets up to and including the bucket to contain the record. Each time bucket reformatting occurs, response time suffers. Therefore, writing the highest-numbered record first forces formatting of the entire file only once. However, this technique can waste disk space if the file is only partially loaded and not preallocated.



### 15.7.3 Indexed Files

An indexed file contains data records and pointers to facilitate record access.

All data records and record pointers are stored in buckets. A bucket contains an integral number of contiguous, 512-byte blocks. The number of blocks is the bucket size.

Every indexed file must have a primary key, a field in the record description that contains a value for each record. When the I/O system writes records to the indexed file, it collates them according to increasing primary key value in a series of chained buckets. Thus, you can access the records sequentially by specifying ACCESS SEQUENTIAL.

As the I/O system writes records, it builds and maintains a tree-like structure of key-value and location pointers. The highest level of the index is a single bucket, called the root bucket. The I/O system scans one bucket at each level until it reaches the bottom, or data level. In a primary key index, this level contains actual data records. Buckets in each higher level, called index levels, contain index records. Successive levels of an index file are numbered. The data level is level zero. The number of levels above level zero is called the index depth. Figure 15-2 shows a 2-level primary index.

Figure 15-2 Two-Level Primary Index

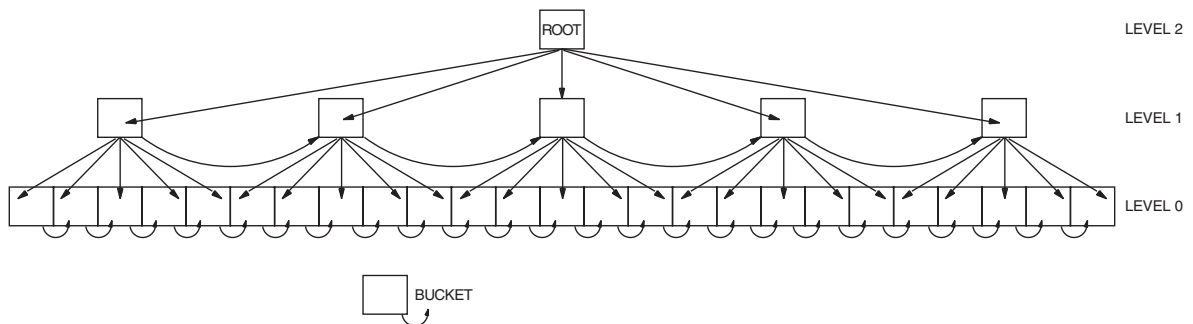

ZK-1540-GE

An index is also built for each alternate key that you define for the file. Like the primary index, alternate key indexes are contained in the file. The collating and chaining done for primary keys are also done for alternate keys. However, alternate keys do not contain data records at the data level; instead, they contain pointers, or secondary index data records (SIDRs), to data records in the data level of the primary index.

Each random access request begins by comparing a key value to the root bucket's entries. It seeks the first root bucket entry whose key value equals or exceeds the value of the access request key. (This search is always successful, because the root bucket's highest key value is the highest possible value that the key field can contain.) Once that key value is located, the bucket pointer is used to bring the target bucket on the next lower level into memory. This process is repeated for each level of the index.

One bucket is searched at each level of the index until a target bucket is reached at the data level. The data record's location is then determined so that a record can be retrieved or a new record written.

## Optimizing Your HP COBOL Program

### 15.7 Optimizing File Design (OpenVMS)

A data level bucket may not be large enough to contain a new record. In this case, the I/O system inserts a new bucket in the chain, moving enough records from the old bucket to preserve the key value sequence. This is known as a bucket split.

Data bucket splits can cause index bucket splits.

#### 15.7.3.1 Optimizing Indexed File I/O

I/O optimization of an indexed file depends on five concepts:

- Records—The size and format of the data records can affect the disk space used by the file.
- Keys—The number of keys and existence of duplicate key values can affect disk space and processing time.
- Buckets—Bucket size can affect disk space and processing time. Index depth and file activity can affect bucket size.
- Index depth—The depth of the index can affect bucket size and processing time.
- File size—The length of files affects space and access time.

#### Records

Variable-length records can save file space: you need write only the primary record key data item (plus alternate keys, if any) for each record. In contrast, fixed-length records require that all records be equal in length.

For example, assume that you are designing an employee master file. A variable-length record file lets you write a long record for a senior employee with a large amount of historical data, and a short record for a new employee with less historical data.

In the following example of a variable-length record description, integer 10 of the RECORD VARYING clause represents the length of the primary record key, while integer 80 describes the length of the longest record in A-FILE:

```
FILE-CONTROL.  
    SELECT A-FILE ASSIGN TO "AMAST"  
        ORGANIZATION IS INDEXED.  
DATA DIVISION.  
FILE SECTION.  
FD  A-FILE  
    ACCESS MODE IS DYNAMIC  
    RECORD KEY IS A-KEY  
    RECORD VARYING FROM 10 TO 80 CHARACTERS.  
01  A-REC.  
    03  A-KEY          PIC X(10).  
    03  A-REST-OF-REC PIC X(70).  
    .  
    .  
    .
```

Buckets must contain enough room for record insertion, or bucket splitting occurs. The I/O system handles it by creating a new data bucket for the split, moving some records from the original to the new bucket, and putting the pointer to the new bucket into the lowest-level index bucket. If the lowest-level index bucket overflows, the I/O system splits it in similar fashion, on up to the top level (root level).

In an indexed file, the I/O system also maintains chains of forward pointers through the buckets.

## Optimizing Your HP COBOL Program 15.7 Optimizing File Design (OpenVMS)

For each record moved, a 7-byte pointer to the new record location remains in the original bucket. Thus, bucket splits can accumulate overhead and possibly reduce usable space so much that the original bucket can no longer receive records.

Record deletions can also accumulate storage overhead. However, most of the space is available for reuse.

There are several ways to minimize overhead accumulation. First, determine or estimate the frequency of certain operations. For example, if you expect to add or delete 100 records of a 100,000-record file, your database is stable enough to allow some wasted space for record additions and deletions. However, if you expect frequent additions and deletions, try to:

- Choose a bucket size that allows for overhead accumulation, if possible. Avoid bucket sizes that are an exact or near multiple of your record size. See the Bucket Size section below.
- Optimize record insertion by using the RMS DEFINE Utility (refer to the *OpenVMS Record Management Utilities Reference Manual*) to define the file with fill numbers; use the APPLY FILL-SIZE clause when loading the file.

### Alternate Keys

Each alternate key requires the creation and maintenance of a separate index structure. The more keys you define, the longer each WRITE, REWRITE, and DELETE operation takes. (The throughput of READ operations is not affected by multiple keys.)

If your application requires alternate keys, you can minimize I/O processing time if you avoid duplicate alternate keys. Duplicate keys can create long record pointer arrays, which fill bucket space and increase access time.

### Bucket Size

Bucket size selection can influence indexed file performance.

To the system, bucket size is an integral number of physical blocks, each 512 bytes long. Thus, a bucket size of 1 specifies a 512-byte bucket, while a bucket size of 2 specifies a 1024-byte bucket, and so on.

The HP COBOL compiler passes bucket size values to the I/O system based on what you specify in the BLOCK CONTAINS clause. In this case, you express bucket size in terms of records or characters.

If you specify block size in records, the bucket can contain more records than you specify, but never fewer. For example, assume that your file contains fixed-length, 100-byte records, and you want each bucket to contain five records, as follows:

```
BLOCK CONTAINS 5 RECORDS
```

This appears to define a bucket as a 512-byte block, containing five records of 100 bytes each. However, the compiler adds I/O system record and bucket overhead to each bucket, as follows:

Bucket overhead	= 15 bytes per bucket
Record overhead	= 7 bytes per record (fixed-length) 9 bytes per record (variable-length)

Thus, in this example, the bucket size calculation is:

Bucket overhead	= 15 bytes
-----------------	------------

## Optimizing Your HP COBOL Program

### 15.7 Optimizing File Design (OpenVMS)

Total record space is  $(100 + 7) * 5 = \underline{535 \text{ bytes}}$  (Record size is 100 bytes, record overhead is 7 bytes for each of 5 records)

TOTAL = 550 bytes

Because blocks are 512 bytes long, and buckets are always an integral number of blocks, the smallest bucket size possible (the system default) in this case is two blocks. The system, however, puts in as many records as fit into each bucket. Thus, the bucket actually contains nine records, not five.

The CHARACTERS option of the BLOCK CONTAINS clause lets you specify bucket size more directly. For example:

```
BLOCK CONTAINS 2048 CHARACTERS
```

This specifies a bucket size of four 512-byte blocks. The number of characters in a bucket is always a multiple of 512. If not, the I/O system rounds it to the next higher multiple of 512.

#### Index Depth

The length of data records, key fields, and buckets in the file determines the depth of the index. Index depth, in turn, determines the number of disk accesses needed to retrieve a record. The smaller the index depth, the better the performance. In general, an index depth of 3 or 4 gives satisfactory performance. If your calculated index depth is greater than 4, you should consider redesigning the file.

You can optimize your file's index depth after you have determined file, record, and key size. Calculating index depth is an iterative process, with bucket size as the variable. Keep in mind that the highest level (root level) can contain only one bucket.

If much data is added over time to an indexed file, you should reorganize the file periodically to restore its indexes to their optimal levels.

Following is detailed information on calculating file size, and an example of index depth calculation:

#### File Size

When you calculate file size:

- Every bucket in an indexed file contains 15 bytes of overhead.
- Every bucket in an indexed file contains records. Only record type and size differ.
- Data records are only in level 0 buckets of the primary index.
- Index records are in level 1 and higher-numbered buckets.
- If you use alternate keys, secondary index data records (SIDRs) are only in level 0 buckets of alternate indexes.

Use these calculations to determine data and index record size:

- Data records:

$$\text{Fixed-length record size} = \text{actual record size} + 7$$

$$\text{Variable-length record size} = \text{actual record size} + 9$$

## Optimizing Your HP COBOL Program 15.7 Optimizing File Design (OpenVMS)

- Index records:

$$\text{Record size} = \text{key size} + 3$$

If a file has more than 65,536 blocks, the 3-byte index record overhead could increase to 5 bytes.

Use these calculations to determine SIDR record length:

- No duplicates allowed:

$$\text{Record size} = \text{key size} + 9$$

- Duplicates allowed:

$$\text{Record size} = \text{key size} + 8 + 5 * (\text{number of duplicate records})$$

---

### Note

---

Bucket packing efficiency determines how well bucket space is used. A packing efficiency of 1 means the buckets of an index are full. A packing efficiency of .5 means that, on the average, the buckets are half full.

---

Consider an indexed file with these attributes:

- 100,000 fixed-length records of 200 characters each
- Primary key = 20 characters
- Alternate key = 8 characters, no duplicates allowed
- Bucket size = 3 (an arbitrary value)
- No fill number

#### Primary key index level calculations:

In the following calculations, some results are to be rounded up, and some truncated.

Level 0 (data level buckets):

$$\begin{aligned} \text{data records per bucket} &= \frac{\text{bytes per bucket} - 15}{\text{record size} + 7} \text{ (result is truncated)} \\ &= \frac{1536 - 15}{200 + 7} = 7 \text{ data records per bucket} \\ \text{number of data buckets} &= \frac{\text{number of data records}}{\text{records per bucket}} \text{ (result is rounded up)} \\ &= \frac{100,000}{7} = 14,286 \text{ buckets to contain all data records.} \end{aligned}$$

Level 1 (index buckets):

$$\begin{aligned} \text{index records per bucket} &= \frac{\text{bytes per bucket} - 15}{\text{key size} + 3} \text{ (result is truncated)} \\ &= \frac{1536 - 15}{20 + 3} = 66 \text{ index records per bucket} \\ \text{number of index buckets} &= \frac{\text{no. of buckets from level } (n - 1)}{\text{index records per bucket}} \text{ (result is rounded up)} \\ &= \frac{14,286}{66} = 217 \text{ level 1 buckets to address all data buckets at level 0} \end{aligned}$$

## Optimizing Your HP COBOL Program

### 15.7 Optimizing File Design (OpenVMS)

Continue calculating index depth until you reach the root level—that is, when the number of buckets needed to address the buckets from the previous level equals 1.

Level 2 (index buckets):

$$\text{number of buckets} = \frac{217}{66} = 4 \text{ level 2 buckets to address all level 1 buckets}$$

Level 3 (index buckets):

$$\text{number of buckets} = \frac{4}{66} = 1 \text{ level 3 bucket to address all}$$

*level 2 buckets (Level 3 is the root bucket for the primary index.)*

#### 15.7.3.2 Calculating Key Index Levels

If you allow duplicate keys in alternate indexes, the number and size of SIDRs depend on the number of duplicate key values in the file. (For duplicate key alternate index calculations, refer to the *OpenVMS Record Management Services Reference Manual*.) Because alternate index records are usually inserted in random order, the bucket packing efficiency ranges from about .5 to about .65. The following example uses an average efficiency of .55.

In each of the following calculations, the results are either rounded up or truncated.

Level 0 (data level buckets—no duplicate alternate keys):

$$\text{SIDRs per bucket} = \frac{\text{bytes per bucket} - 15}{\text{key size} + 9} \text{ (result is truncated)}$$

$$= \frac{1536 - 15}{8 + 9} = 89 \text{ SIDRs per bucket}$$

$$\text{number of buckets} = \frac{\text{number of records}}{\text{records per bucket}} \text{ (result is rounded up)}$$

$$= \frac{100,000}{89} = 1124 \text{ level 0 alternate index buckets}$$

Level 1 (index buckets):

$$\text{records per bucket} = \frac{1536 - 15}{8 + 3} = 138 \text{ index records per bucket ...}$$

$$\dots \text{ number of buckets} = \frac{1124}{138} = 9 \text{ level 1 buckets to address data buckets (SIDRs)}$$

*at level 0*

Level 2 (index buckets):

$$\text{number of buckets} = \frac{9}{138} = 1 \text{ level 2 bucket to address data buckets}$$

*at level 1 (level 2 is the root level)*

### 15.7.3.3 Caching Index Roots

The system requires at least two buffers to process an indexed file: one for a data bucket, the other for an index bucket. In fact, a data buffer and an index buffer are needed for every level of indexing available in the file (a fact that is not visible to the COBOL program, because the minimum amount of space is always allocated). Each buffer is large enough to contain a single bucket. If your program does not contain a RESERVE n AREAS clause, or if you do not use the DCL SET RMS\_DEFAULT command, the system sets the default.

A RESERVE n AREAS clause creates additional buffers for processing an indexed file. At run time, the system retains (caches) in memory the roots of one or more indexes of the file. Random access to any record through that index requires one less I/O operation.

You can also use the SET RMS\_DEFAULT/BUFFER\_COUNT=count to create additional buffers.

The following rules apply for caching index roots:

- Allocate one buffer for each key that your program uses to access file records, in addition to the two required buffers. For example, if the file contains a primary key and two alternate keys, and you use all these keys to access records, allocate a total of five buffers. If you use only one key, you need only one additional buffer area, or a total of three.
- Use the RESERVE n AREAS clause to obtain allocation, where n is two more than the number of distinct keys used for access. For example, the RESERVE 5 AREAS clause allocates two required buffers, plus three buffer areas for caching the roots of three distinct file access keys.
- Use the DCL SET RMS\_DEFAULT/BUFFER\_COUNT=count command if you want to allocate buffers without specifying the RESERVE AREA clause in your program, or for buffer allocation on a process or systemwide basis.

The DCL SET RMS commands also apply to sequential and relative files. The DCL SET RMS commands and RESERVE AREA clause provide the same functionality.

For information about DCL commands, refer to the *OpenVMS DCL Dictionary*.

◆

## 15.8 Image Activation Optimization (Tru64 UNIX)

Shared objects are checksummed when images are activated. If the checksum does not match, symbols will be re-resolved, extending image activation time for existing images. You can avoid this potential performance hit by relinking. Relinking can improve image activation time for any HP COBOL applications that were built -call\_shared (which is the default). ◆





---

## Managing Memory and Data Access

HP COBOL provides compile-time mechanisms you can select to control run-time memory access. Effective memory management can improve:

- Compile-time performance
- Run-time performance
- Compatibility
- System resource usage

You place compiler command-line qualifiers and flags, and/or embedded directives in your source code to alter data alignment and to structure memory references. All such directives begin with the characters `*DC`, where the asterisk (\*) signals the beginning of the structured comment to the compiler. You use these alignment directives exclusively in the Data Division. (If you compile this code on HP COBOL for OpenVMS VAX, a structured comment `*DC` directive is treated like any other comment and ignored.)

This chapter provides the following information about managing memory and data access:

- Managing memory granularity (Alpha, I64) (Section 16.1)
- Using the `VOLATILE` compiler directive (Alpha, I64) (Section 16.2)
- Aligning data for performance and compatibility (Alpha, I64) (Section 16.3)
- Using alignment directives, qualifiers, and flags (Alpha, I64) (Section 16.4)

### 16.1 Managing Memory Granularity (Alpha, I64)

You can control the HP COBOL compiler *granularity* to set the minimum size of a memory access. Granularity refers to the amount of storage that can be modified when updating a data item.

The form on Tru64 UNIX systems is:

```
-granularity option ◆
```

The form on OpenVMS Alpha and I64 systems is:

```
/GRANULARITY=option ◆
```

You can specify the following values for *option*:

- byte
- long
- quad (default)

## Managing Memory and Data Access

### 16.1 Managing Memory Granularity (Alpha, I64)

To update a data byte, the HP COBOL compiler will issue a sequence of instructions to fetch the longword or quadword containing the byte, update the memory inside the longword or quadword, and then write the longword or quadword back to memory.

If different processes sharing memory try concurrently to update different parts of the same aligned quadword, this multi-instruction sequence can cause one of the updates to be lost. If you have multiple processes concurrently updating different bytes within the same aligned quadword, you should use byte granularity. Use longword granularity for better performance if you are sure the processes never make concurrent updates within the same aligned longword. Use quadword granularity for best performance if you are sure the processes never make concurrent updates within the same aligned quadword.

To successfully use byte/word granularity, you need to consider at least four important restrictions:

- An EV56 or higher CPU is necessary for byte/word granularity.
- LIBOTS.EXE support for byte/word granularity is necessary if PIC X support is needed. However, LIBOTS.EXE Version 1.3 on OpenVMS Alpha Version 7.1 does not support byte/word granularity.
- Use of PIC 9 COMP-3 (PACKED numerics) and PIC 9 (DISPLAY numerics) should be restricted, because they do not have byte/word granularity support.
- You need to evaluate any NONGRNACC diagnostics as potential sources of incorrect data update. These warnings contain critical information and must not be ignored.

You should avoid the use of /GRANULARITY=BYTE unless all of these requirements are met.

In the following example (which is OpenVMS specific), the warnings at lines 16, 17, and 18 must be heeded. If this application is run on a CPU that supports byte/word granularity, the warning at line 16 (PIC X) indicates that the move will not produce byte granularity unless it is run on a system with a LIBOTS.EXE version that supports byte/word granularity. The warnings at line 17 (PIC 9 display numeric) and line 18 (PIC 9 COMP-3 packed numeric) indicate that these moves will not produce byte granularity.

```
$ cobol c3484/granularity=byte/list=sys$output
C3484 Source Listing 5-JUN-2004 07:37:22 HP COBOL V2.8-1060 Page 1

1 identification division.
2 program-id. c3484.
3 environment division.
4 data division.
5 working-storage section.
6 01 w1.
7 03 a1 pic 9(9) comp.
8 03 a2 pic 9(4) comp.
9 03 a3 pic x(9).
10 03 a4 pic 9(9).
11 03 w2 occurs 3 times.
12 05 a5 pic 9(18) comp-3.
13 procedure division.
14 0. move 1 to a1.
15 move 2 to a2.
16 move "c" to a3.
.....1
%COBOL-W-NONGRNACC, (1) Unable to generate code for requested granularity
```

## Managing Memory and Data Access

### 16.1 Managing Memory Granularity (Alpha, I64)

```
17 move 4 to a4.
.....1
%COBOL-W-NONGRNACC, (1) Unable to generate code for requested granularity
18 move 5 to a5(2).
.....1
%COBOL-W-NONGRNACC, (1) Unable to generate code for requested granularity
19 if a1 not = 1 display "?1".
20 if a2 not = 2 display "?2".
21 if a3(1:1) not = "c" display "?3 ".
22 if a4 not = 4 display "?4".
23 if a5(2) not = 5 display "?5".
24 stop run.
```

### 16.2 Using the VOLATILE Compiler Directive (Alpha, I64)

VOLATILE directives offer flexibility and selectivity: they alter the current storage of certain data items by specifying new storage information from within the program source.

The SET VOLATILE directive enables you to direct that certain data items be stored in memory, rather than in machine registers. This technique is useful for declaring data that is to be accessed asynchronously. (Device driver applications often use volatile data storage.)

The forms of the VOLATILE directives are as follows:

```
*DC SET VOLATILE
*DC SET NOVOLATILE
*DC END-SET VOLATILE
```

In your application you specify \*DC SET VOLATILE to begin a range of data declarations with this attribute set. You terminate the volatile attribute range with the \*DC END-SET VOLATILE (or \*DC SET NOVOLATILE) directive. Subsequent declarations will not be affected.

### 16.3 Aligning Data for Performance and Compatibility (Alpha, I64)

Proper alignment is important for HP COBOL applications on Tru64 UNIX, OpenVMS Alpha, and OpenVMS I64 platforms. Manipulation of binary data (that is, COMP, COMP-1, COMP-2, INDEX, and POINTER data items) is significantly faster if alignment is on natural boundaries. A natural boundary is the smallest boundary at which data can be aligned without crossing the next boundary for that type. (For example, longword is the natural boundary for four-byte integers.)

Two forms of alignment are available in HP COBOL. The basic form of alignment allows you to align only elementary data items without padding the record structures and substructures within which they reside. The alternate form, which is Alpha alignment and padding, aligns both the elementary data items and the structures and substructures in which they are found. It also pads out those structures and substructures to lengths which are multiples of their alignments. This form of alignment and padding conforms to the *HP OpenVMS Calling Standard*.

OpenVMS VAX compatible record layouts are available for compatibility with applications running on OpenVMS VAX platforms, including HP COBOL for OpenVMS VAX.

## Managing Memory and Data Access

### 16.3 Aligning Data for Performance and Compatibility (Alpha, I64)

#### 16.3.1 Data Boundaries (Alpha, I64)

Natural alignment for binary data is detailed in Table 16–1. The boundaries described in Table 16–1 are specified in the *HP OpenVMS Calling Standard*. The table generally applies both to Tru64 UNIX and to OpenVMS Alpha, with the exception that IEEE is the only floating point data type on the Tru64 UNIX operating system.

**Table 16–1 Boundaries for Naturally Aligned Binary Data (Alpha, I64)**

COBOL USAGE	PICTURE Declaration	Alpha, I64 Standard Data Type	Natural Alignment	Allocated Storage
DISPLAY	PIC A PIC X PIC 9 PIC EDITED	8-bit character string	BYTE	1 byte
COMP	PIC [S]9(1-4)	16-bit word integer	WORD	2 bytes
	PIC [S]9(5-9)	32-bit longword integer	LONGWORD	4 bytes
	PIC [S]9(10-18)	64-bit quadword integer	QUADWORD	8 bytes
	PIC [S]9(19-31)	128-bit octaword integer	QUADWORD	16 bytes
COMP-1	Not applicable	32-bit F-floating 32-bit IEEE S-floating	LONGWORD	4 bytes 4 bytes
COMP-2	Not applicable	64-bit D-floating 64-bit G-floating 64-bit IEEE T-floating	QUADWORD	8 bytes 8 bytes 8 bytes
INDEX	Not applicable	32-bit longword integer	LONGWORD	4 bytes <sup>1</sup>
POINTER	Not applicable	32-bit longword integer	LONGWORD	4 bytes <sup>2</sup>

<sup>1</sup> On the Alpha and I64 systems, USAGE IS INDEX is allocated as a longword integer for OpenVMS VAX compatibility. On the Tru64 UNIX system, it is allocated as a 64-bit quadword integer, with 8 bytes of storage.

<sup>2</sup> On Alpha and I64 systems, HP COBOL allocates 4 bytes for POINTER data to maintain HP COBOL for OpenVMS VAX compatibility. On the Tru64 UNIX system, it allocates 8 bytes for POINTER data (a 64-bit quadword integer).

#### 16.3.2 Data Field Padding (Alpha, I64)

In HP COBOL, all 01 and 77-level data items are always aligned on quadword boundaries. With Alpha natural alignment and padding invoked, the lengths of all data-items are compiled to be multiples of the greatest alignment of any subordinate elementary field.

The compiler will flag (with an Informational diagnostic) all fields that might incur side effects when compiled with alignment and padding enabled.

#### 16.3.3 Alignment Directives, Qualifiers, and Flags (Alpha, I64)

Within your program, you can specify alignment with the alignment directives, which consist of structured comments embedded within the DATA DIVISION of the program source.

When you compile a COBOL program, you can use the /ALIGNMENT qualifier or the /ALIGNMENT=Padding qualifier on Alpha and I64 systems and -align or -align pad on Tru64 UNIX systems to specify aligned elementary data items or naturally aligned and padded record layouts for optimal performance. If you do not specify this option, the default alignment is used, which is OpenVMS VAX

## Managing Memory and Data Access

### 16.3 Aligning Data for Performance and Compatibility (Alpha, I64)

compatible record layouts for compatibility with HP COBOL for OpenVMS VAX and other OpenVMS VAX languages.

In addition to the primary goal of optimum performance, specifying data alignment offers the following advantages:

- Ease of use and conversion—You might need to make a minimal number of changes to existing source files before compiling them with the HP COBOL compiler. In some cases, all you need to do is specify the `-align` flag or the `/ALIGNMENT` qualifier with or without the padding option when you compile.
- Flexibility—You can specify VAX compatible alignment (byte alignment) or natural alignment on a record-by-record basis. For example, you can specify VAX compatible alignment for files shared by both compilers and natural alignment for HP COBOL-only files and records.

---

#### Note

---

The two types of padding (use of alignment with the `PADDING` option, or use of `*DC SET PADALIGN`) are not recommended in a COBOL program that contains the `REDEFINES` or `RENAMES` syntax.

---

#### 16.3.4 Specifying Alignment at Compile Time (Alpha, I64)

The result of the alignment command-line option is identical on the OpenVMS Alpha, OpenVMS I64 and the Tru64 UNIX operating systems.

On Alpha and I64 systems, the `/ALIGNMENT` qualifier used with the COBOL command aligns data on Alpha natural boundaries and optionally pads data structures that contain them, in conformity with the *HP OpenVMS Calling Standard*. The format of the `/ALIGNMENT` qualifier is as follows:

```
/ALIGNMENT[=[NO]PADDING] or /NOALIGNMENT ◆
```

On Tru64 UNIX systems, you use the `-align` flag with the `cobol` command to align elementary data items on Alpha natural boundaries and optionally to pad data structures which contain them, in conformity with the *HP OpenVMS Calling Standard*. The format of the `-align` flag is as follows:

```
-align [padding] ◆
```

On all three platforms, the default is alignment on Alpha natural boundaries and no padding of interior or terminal fields (for 01-level data items and data structures).

The alignment command-line qualifier or flag specifies the minimum alignment for data items specified within the program source when no additional alignment information has been specified. You can specify the minimum alignment of specific data items within your program by including compiler directives in the program source.

The `-align` flag or the `/ALIGNMENT` qualifier aligns all `COMP`, `COMP-1`, `COMP-2`, `INDEX`, and `POINTER` data along natural boundaries. (See Table 16–1.)

By default, alignment is turned off and data is aligned on byte boundaries.

The alignment specified in the compile command is in force throughout a given compilation, except as modified by any compiler directives. In addition, the alignment of elementary binary data that has been specified with the `SYNCHRONIZED` clause is unchanged.

## Managing Memory and Data Access

### 16.4 Using Alignment Directives, Qualifiers, and Flags (Alpha, I64)

#### 16.4 Using Alignment Directives, Qualifiers, and Flags (Alpha, I64)

Alignment directives offer flexibility and selectivity: they alter the current alignment by specifying new alignment information from within the source program.

The forms of the alignment directives are as follows:

```
*DC SET ALIGNMENT
*DC SET NOALIGNMENT
*DC END-SET ALIGNMENT

*DC SET PADALIGN
*DC SET NOPADALIGN
*DC END-SET PADALIGN
```

The `*DC SET ALIGNMENT` directive and the `*DC SET PADALIGN` directive function independently of each other, except when their scopes overlap in the program source. In case of overlapping scope, the effect of the `*DC SET PADALIGN` directive prevails.

The `*DC SET ALIGNMENT` directive specifies natural Alpha alignment of elementary data items. The `*DC SET PADALIGN` specifies Alpha natural alignment and padding.

The `*DC SET NOALIGNMENT` directive specifies OpenVMS VAX compatible alignment.

The optional `*DC END-SET ALIGNMENT` directive terminates the current `*DC SET ALIGNMENT` or `*DC SET NOALIGNMENT` directive that is currently in effect.

The alignment of binary data that has been specified with the `SYNCHRONIZED` clause is unaffected by the `*DC SET ALIGNMENT` and `*DC SET PADALIGN` directives.

When you use an alignment directive or qualifier to align data in records, you should consider whether the data will be written to a file to be accessed by applications written in HP COBOL for OpenVMS VAX.

---

#### Note

---

These directives are not allowed in the PROCEDURE DIVISION of a program source.

---

##### 16.4.1 Order of Alignment Operations (Alpha, I64)

Table 16–2 shows the order of precedence of the primary alignment qualifiers and directives in HP COBOL.

## Managing Memory and Data Access

### 16.4 Using Alignment Directives, Qualifiers, and Flags (Alpha, I64)

**Table 16–2 Alignment and Padding Order of Precedence (Alpha, I64)**

Command line Qualifier and Option	Compiler Directives			
	No Directive in Effect	*DC SET ALIGNMENT	*DC SET PADALIGN	*DC SET NOALIGN
(none)	None	Align elementary data items.	Align and pad elementary data items and structures.	None
/ALIGNMENT -align	Align elementary data items.	Align elementary data items.	Align and pad elementary data items and structures.	None
/ALIGN=PAD -align pad	Align and pad elementary data items and structures.	Align elementary data items and structures.	Align and pad elementary data items.	None

#### 16.4.2 Nesting Alignment Directives (Alpha, I64)

Alignment directives located within the source program alter the current alignment by specifying a new alignment, which remains in effect (except for data specified with SYNCHRONIZED, which remains unchanged) until changed precedence, or until the beginning of the next file specified in a comma list. You can nest alignment directives within a program to specify different alignments for selected sets of data. Alignment directives do the following:

- A SET ALIGNMENT (or SET NOALIGNMENT) directive. At this point in the program source the alignment specified by this directive becomes the current alignment.
- An END-SET ALIGNMENT directive. At this point, the immediately preceding SET ALIGNMENT (or SET NOALIGNMENT) directive is closed. The current alignment now becomes one of the following:
  - The alignment specified by the closest previous unclosed alignment directive
  - The alignment specified by the command-line option if no previous alignment directive exists
- The beginning of the next file specified in a comma list (on the HP COBOL command line). This event closes all of the preceding alignment directives. The alignment specified with the command-line option becomes the current alignment.

Example 16–1 shows an example of nested alignment directives in source code.

## Managing Memory and Data Access

### 16.4 Using Alignment Directives, Qualifiers, and Flags (Alpha, I64)

#### Example 16–1 Using \*DC SET ALIGNMENT Directives

```
.
.
.
*DC SET ALIGNMENT
01 comp-group.
   02 cg-x1  pic x.
   02 cg-c1  pic 9(1) comp.
*DC SET NOALIGNMENT
01 comp-group-2.
   02 cg-x2  pic x.
   02 cg-c2  pic 9(1) comp.
*DC END-SET ALIGNMENT
01 comp-group-3.
   02 cg-x3  pic x.
   02 cg-c3  pic 9(1) comp.
*DC END-SET ALIGNMENT
01 comp-group-4.
   02 cg-x4  pic x.
   02 cg-c4  pic 9(1) comp.
```

- ❶ Initially, OpenVMS VAX compatible alignment is specified either by NOALIGNMENT or the absence of ALIGN on the compile command.
- ❷ The SET ALIGNMENT directive specifies alignment along natural boundaries, superseding the initial OpenVMS VAX compatible alignment.
- ❸ The SET NOALIGNMENT directive specifies VAX compatible alignment; data is now byte-aligned.
- ❹ The END-SET ALIGNMENT directive terminates the alignment specified with the previous SET directive (❸ SET NOALIGNMENT). Alignment is once again along the natural boundaries as specified by ❷, the SET ALIGNMENT directive.
- ❺ This END-SET ALIGNMENT directive terminates the alignment specified with the original directive (❷ SET ALIGNMENT). Alignment is now OpenVMS VAX compatible as specified by the default command-line option. ♦

#### 16.4.2.1 SYNCHRONIZED Clause

The SYNCHRONIZED clause, which aligns binary data on natural boundaries, is included in both HP COBOL and HP COBOL for OpenVMS VAX. Refer to the *HP COBOL Reference Manual* for complete information on the SYNCHRONIZED clause.



## Managing Memory and Data Access

### 16.4 Using Alignment Directives, Qualifiers, and Flags (Alpha, I64)

#### 16.4.3 Comparing Alignment Directive Effects

The alignment examples that follow illustrate the following important points:

- HP COBOL for OpenVMS VAX and HP COBOL align 01 (and 77) data items along different boundaries, as follows:
  - HP COBOL for OpenVMS VAX aligns 01 data records and items along longword boundaries. It byte-aligns all other fields unless SYNC has been specified.
  - HP COBOL aligns 01 records and items along quadword boundaries. It byte-aligns all other fields unless SYNC or the alignment option has been specified.
- On Alpha and I64, the effects of the SYNCHRONIZED clause, the alignment command-line option, and the SET ALIGNMENT directive on elementary data alignment are identical.

Example 16–2 through Example 16–6 show a comparison of the use and results of several alignment cases. They are applicable to Tru64 UNIX, OpenVMS I64 and OpenVMS Alpha; and Example 16–2 is additionally applicable to OpenVMS VAX (except for the information on the /ALIGNMENT qualifier, which is Alpha- and I64- specific). Example 16–2 shows the effects of the SYNCHRONIZED clause in program source, as compared with the /ALIGNMENT qualifier on the command line.

#### Example 16–2 Using /ALIGNMENT with SYNCHRONIZED

```

01 comp-group.
   02 cg-x1   pic x.           ❶
   02 cg-c1   pic 9(1) comp.   ❷
   02 cg-c3   pic 9(3) comp.   ❸
   02 cg-c7   pic 9(7) comp.   ❹
   02 cg-c12  pic 9(12) comp.  ❺
01 comp-group-synch.
   02 cg-x1-synch  pic x.           ❻
   02 cg-c1-synch  pic 9(1) comp synchronized.  ❼
   02 cg-c3-synch  pic 9(3) comp synchronized.  ❸
   02 cg-c7-synch  pic 9(7) comp synchronized.  ❹
   02 cg-c12-synch pic 9(12) comp synchronized.  ❺

```

The data is aligned as shown in the following examples using different alignment configurations. In the accompanying data diagrams, a number (n) indicates that that byte is occupied by the nth field of the record, and a dash (—) indicates a filler byte. The fields are indicated by the callouts in the right column of Example 16–2.

HP COBOL for OpenVMS VAX would align the data as follows:

```

| 1223 | 3444 | 4555 | 5555 | 5 | 6-77 | 88-- | 9999 | ---- | 1111 | 1111 |

```

## Managing Memory and Data Access

### 16.4 Using Alignment Directives, Qualifiers, and Flags (Alpha, I64)

HP COBOL without the `-align` flag or the `/ALIGNMENT` qualifier or with the `/NOALIGNMENT` qualifier would align the data as follows:

```
| 1223 | 3444 | 4555 | 5555 | 5   |      | 6-77 | 88-- | 9999 | ---- | 1111 | 1111 |
|      |      |      |      |      |      |      |      |      |      | 0000 | 0000 |
```

And finally, HP COBOL *with* the `-align` flag or the `/ALIGNMENT` qualifier would align the data as follows:

```
| 1-22 | 33-- | 4444 | ---- | 5555 | 5555 | 6-77 | 88-- | 9999 | ---- | 1111 | 1111 |
|      |      |      |      |      |      |      |      |      |      | 0000 | 0000 |
```

The examples that follow are applicable to Alpha and I64 only.

Example 16–3 shows the differences in the actions of `/NOALIGN`, `/ALIGN` and `-align`, and `/ALIGN=PADDING` and `-align pad` on the internal alignments of data fields within COBOL data structures in the Alpha, I64 and Tru64 UNIX environments.

The program fragment in Example 16–3 was extracted from a COBOL program that was compiled three times on HP COBOL, using the following qualifiers for each compilation:

1. **`/LIST/MAP=D`**—No alignment and no padding, as in HP COBOL for OpenVMS VAX (see Example 16–4)
2. **`/ALIGN/LIST/MAP=D`**—HP COBOL V1.0-style field elementary alignment, but no Alpha natural alignment and padding (see Example 16–5)
3. **`/ALIGN=PAD/LIST/MAP=D`**—Alpha natural alignment and padding (see Example 16–6)

The excerpts of the Data Names in Declared Order from the listing maps show the differences in vertical format in the Location and Byte columns. Note the horizontal byte layouts to make it easier to read in that orientation.

Example 16–3 shows that `/ALIGNMENT` without `PADDING` will align internal `COMP` fields in the record format on longword boundaries, but will not pad out the lengths of substructures to be multiples of the alignments of the most strongly aligned fields within them. Also, it does not pad the entire data structure. Alternatively, `/ALIGNMENT=PADDING` pads internal substructures as well as the entire record. The result is many more slack bytes in the record layout for Example 16–6.

## Managing Memory and Data Access

### 16.4 Using Alignment Directives, Qualifiers, and Flags (Alpha, I64)

#### Example 16–3 Comparing /NOALIGN, /ALIGN and /ALIGN=Padding (Alpha, I64)

```

4 DATA DIVISION.
5 WORKING-STORAGE SECTION.
6
7 01 REC1.
8   02 FLD1.
9     03 FLD1-1 PIC S9(9) USAGE COMP.
10    03 FLD1-2 PIC S9(03)V9(04) USAGE DISPLAY.
11   02 FLD2 PIC X(005).
12   02 FLD3.
13     03 FLD3-1 PIC X.
14     03 FLD3-2 PIC S9(9) USAGE COMP.
15     03 FLD3-3 PIC S9(5) USAGE DISPLAY.

```

#### Example 16–4 Data Map for /NOALIGNMENT (Alpha, I64)

Source Listing							
Data Names in Declared Order							
Line	Level	Name	Location	Size	Bytes	Usage	Category
7	01	REC1	2 00000000	26	26	DISPLAY	Group
8	02	FLD1	2 00000000	11	11	DISPLAY	Group
9	03	FLD1-1	2 00000000	9	4	COMP	N
10	03	FLD1-2	2 00000004	7	7	DISPLAY	N
11	02	FLD2	2 0000000B	5	5	DISPLAY	AN
12	02	FLD3	2 00000010	10	10	DISPLAY	Group
13	03	FLD3-1	2 00000010	1	1	DISPLAY	AN
14	03	FLD3-2	2 00000011	9	4	COMP	N
15	03	FLD3-3	2 00000015	5	5	DISPLAY	N

#### Byte Layout for Example 16–4:

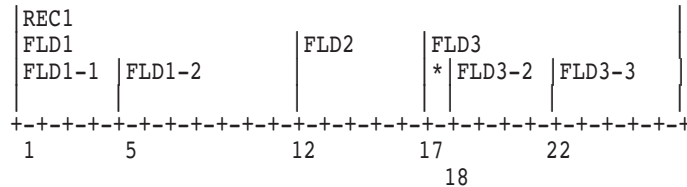

Begin byte number (starting with 0)  
Record length is 26 bytes.

#### Note

The asterisk (\*) designates FLD3-1. Also, no padding or filler will result, just as with HP COBOL for OpenVMS VAX on OpenVMS VAX.

# Managing Memory and Data Access

## 16.4 Using Alignment Directives, Qualifiers, and Flags (Alpha, I64)

**Example 16–5 Data Map for /ALIGNMENT, -align (Alpha, I64)**

Source Listing								
Data Names in Declared Order								
Line	Level	Name	Location	Size	Bytes	Usage	Category	
7	01	REC1	2 00000000	29	29	DISPLAY	Group	
8	02	FLD1	2 00000000	11	11	DISPLAY	Group	
9	03	FLD1-1	2 00000000	9	4	COMP	N	
10	03	FLD1-2	2 00000004	7	7	DISPLAY	N	
11	02	FLD2	2 0000000B	5	5	DISPLAY	AN	
12	02	FLD3	2 00000010	13	13	DISPLAY	Group	
13	03	FLD3-1	2 00000010	1	1	DISPLAY	AN	
14	03	FLD3-2	2 00000014	9	4	COMP	N	
15	03	FLD3-3	2 00000018	5	5	DISPLAY	N	

**Example 16–6 Data Map for /ALIGNMENT=Padding, -align pad (Alpha, I64)**

Source Listing								
Data Names in Declared Order								
Line	Level	Name	Location	Size	Bytes	Usage	Category	
7	01	REC1	2 00000000	36	36	DISPLAY	Group	
8	02	FLD1	2 00000000	12	12	DISPLAY	Group	
9	03	FLD1-1	2 00000000	9	4	COMP	N	
10	03	FLD1-2	2 00000004	7	7	DISPLAY	N	
11	02	FLD2	2 0000000C	5	5	DISPLAY	AN	
12	02	FLD3	2 00000014	16	16	DISPLAY	Group	
13	03	FLD3-1	2 00000014	1	1	DISPLAY	AN	
14	03	FLD3-2	2 00000018	9	4	COMP	N	
15	03	FLD3-3	2 0000001C	5	5	DISPLAY	N	

**Byte Layout for Example 16–5:**

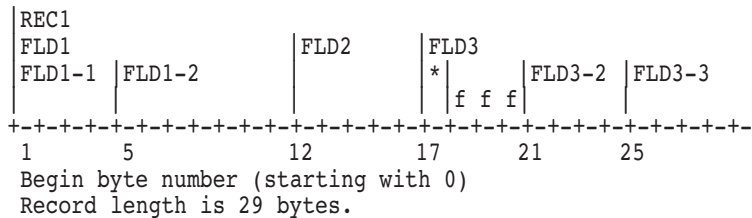

**Notes:**

The asterisk (\*) designates FLD3-1.

The letter **f** designates internal filler bytes produced because the field FLD3-2 has to start on the boundary that is the next higher multiple of 4 because it is longword-aligned. The intervening three bytes following FLD3-1 are skipped over.

## Managing Memory and Data Access

### 16.4 Using Alignment Directives, Qualifiers, and Flags (Alpha, I64)

#### Byte Layout for Example 16-6:

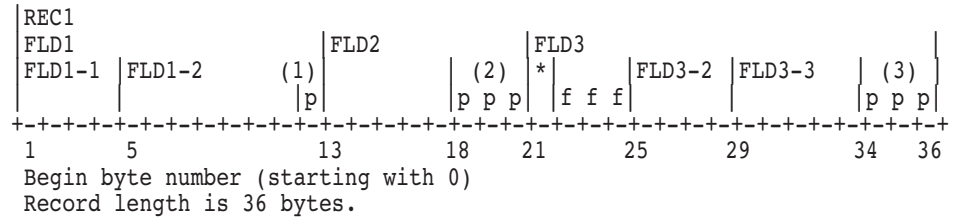

1. This pad byte brings substructure FLD1 up to:  
 $12 = 3 * 4$  bytes - multiple of longword alignment
2. These three pad bytes are skipped over. They are required because FLD3, the next substructure, has to start on a longword boundary because it contains FLD3-2.  
 FLD2 contains five bytes and is padded three bytes out to eight.
3. These three pad bytes bring FLD3 up to:  
 $16 = 4 * 4$  bytes
4. The total number of bytes in the record is now:  
 $36 = 12 + 8 + 16$  bytes
5. \*, p, f apply in the same way as for /ALIGN without PADDING. ♦



---

## Compiler Implementation Specifications

The following list summarizes the specifications and restrictions for the HP COBOL compiler. The compiler issues diagnostic messages whenever you exceed its design parameters.

- Run-time storage (generated object code and data) for COBOL programs cannot exceed 2,147,483,647 bytes.
- The length of an FD's record cannot exceed 32,767 bytes for a sequential file, 32,234 bytes for an indexed file, or 32,255 bytes for a relative file. For SD records, the length cannot exceed 32,759 bytes for a sequential file, 32,226 bytes for an indexed file, or 32,247 bytes for a relative file.
- On OpenVMS, bucket size for relative and indexed files cannot be greater than 63.
- A sequential disk file's multiblock count cannot be greater than 127.
- The physical block size for a sequential tape file must be from 20 to 65,532 bytes, inclusively. ♦
- Run-time storage for an indexed file's RECORD KEY or ALTERNATE RECORD KEY data item must not be greater than:
  - 255 bytes on OpenVMS systems
  - 120 bytes on Tru64 UNIX systems
- The number of bytes in the string making up a VALUE OF ID file name or data name must not exceed 255.
- The number of indexed file RECORD KEY and ALTERNATE RECORD KEY data items must not exceed 255 per file.
- The maximum number of segments in a segmented key is eight.
- The number of literal phrases specified to define an alphabet in an ALPHABET clause of the SPECIAL-NAMES paragraph must not be greater than 256.
- The value of a numeric literal in a literal phrase of an ALPHABET clause must not be greater than 255.
- The value of a switch number in the SWITCH clause of the SPECIAL-NAMES paragraph must be from 1 to 16, inclusively.
- The value of a numeric literal in the SYMBOLIC CHARACTERS clause must be from 1 to 256, inclusively.
- On OpenVMS, the value of an integer in the EXTENSION option of the APPLY clause must be from 0 to 65,535, inclusive.
- The value of an integer in the WINDOW option of the APPLY clause must be from 0 to 127, inclusive, or equal to 255.

## Compiler Implementation Specifications

- The value of the integer in the RESERVE AREAS clause must not be greater than 127.
- If a data item is allocated more than 268,435,455 bytes, a COBOL program cannot reference it except with INITIALIZE and CALL BY REFERENCE.
- Alphanumeric or numeric edited picture character-strings cannot represent more than 255 standard data format characters.
- Alphanumeric or alphabetic picture character-strings cannot represent more than 268,435,455 standard data format characters.
- A nonnumeric literal cannot be greater than 256 characters.
- A hexadecimal literal cannot be greater than 256 hexadecimal digits.
- A PICTURE character-string cannot contain more than 256 characters.
- The number of operands in the USING phrase of a CALL statement cannot be greater than 255.
- The number of USING files in a SORT or MERGE statement cannot exceed 10.
- On OpenVMS, the maximum number of characters in a subschema pathname specification is 256. ♦
- The maximum static nesting depth of contained programs is 256.
- The maximum number of characters in a user-word in HP COBOL is 31. The maximum number of characters allowed in a user-word as defined by the ANSI COBOL standard is 30. The compiler issues an informational diagnostic if you use 31-character user-words. The maximum number of characters in an external report file name is 30.
- On OpenVMS, the maximum number of strings associated with the /AUDIT command line qualifier is 64.
- The maximum number of characters in a Oracle CDD/Repository pathname specification is 256.
- The maximum number of levels in a database subschema record definition supported by HP COBOL is 49.
- The maximum number of digits in a numeric database data item supported by HP COBOL is 31 for Alpha and I64 and 18 for VAX.
- The maximum number of standard data format characters in a character-type database data item is 65,535. ♦
- The maximum number of digits in a picture character string describing fixed-point numeric and numeric-edited data items is 31 for Alpha and I64 and 18 for VAX.
- The maximum number of digits in numeric literals is 31 for Alpha and I64 and 18 for VAX.
- The maximum number of characters in a picture character string is 50.
- The maximum number of digits supported in most intrinsic functions is 31 for Alpha and I64 and 18 for VAX.
- The maximum number of digits in numeric SORT/MERGE keys is 31 for Alpha and I64 and 18 for VAX.



## Compiler Implementation Specifications

- The maximum number of digits in PACKED-DECIMAL (COMP-3) numeric and unsigned DISPLAY numeric ISAM keys is 31 for Alpha and I64 and 18 for VAX.
- The SORT-32 (available on OpenVMS) record size limit is 65,535 bytes.
- The SORT-32 key size limit is 65,529 bytes. ♦
- The Hypersort (available on Alpha and I64) key size limit is 65,535 bytes. ♦
- If a file is assigned to magnetic tape media and you use the BLOCK CONTAINS clause in the associated file description, the number of characters in a physical block determined from the BLOCK CONTAINS clause must be an even multiple of 8.
- If a file is assigned to a disk medium and you use the BLOCK CONTAINS clause in the associated file description, the BLOCK CONTAINS value must be an even multiple of 1024.
- The maximum number of lines in any report file is 999,998,000,001.
- The maximum subscript value for any subscript or index name is 2,147,483,647.
- In the OCCURS  $n$  TIMES clause of a Data Description entry, the maximum allowable value for  $n$  is 2,147,483,647.
- On OpenVMS, the maximum static scoping depth of database USE procedures is 84.
- The maximum number of operands in a given COBOL DML statement is 255. ♦
- In a PERFORM  $n$  TIMES statement, the maximum allowable value for  $n$  is 2,147,483,647.
- The maximum static nesting depth of nested IF statements is 64.
- The maximum number of levels for subscripts is 48.
- The maximum number of files in a MULTIPLE FILE TAPE clause is 255.
- For files assigned to magnetic tape, the record size for variable-length record files cannot exceed 9995 characters.
- For files assigned to magnetic tape, the block size must be from 20 to 999,999 characters, inclusive.
- For files assigned to magnetic tape, the number of files in a given volume set cannot exceed 9999 files.
- The number of magnetic tapes spanned by a single file cannot exceed 9999 tapes.



# B

## HP COBOL on Four Platforms: Compatibility and Migration

HP COBOL on its Alpha platforms (OpenVMS Alpha and Tru64 UNIX) and on its Itanium® platform (OpenVMS I64) is based on and is highly compatible with HP COBOL for OpenVMS VAX. However, there are differences, which are summarized in this appendix.<sup>1</sup> Knowing the differences can help you develop COBOL applications that are compatible with other platforms, and can help you migrate your HP COBOL for OpenVMS VAX applications to HP COBOL on an Alpha or I64 platform.

### B.1 Compatibility Matrix

Table B–1 shows the current (as of the date of publication of this manual) state of compatibility for numerous features in HP COBOL on its three platforms. Always check the Release Notes for the latest developments if there is a question about the availability of a given feature.

#### Legend

- ✓ = Supported
- N = Not supported
- P = Partially supported

**Table B–1 Cross-Platform Compatibility of COBOL Features**

	OpenVMS VAX	OpenVMS Alpha	OpenVMS I64	Tru64 UNIX
/CHECK=DECIMAL	N	✓	✓	✓
/CHECK=(PERFORM,BOUNDS)	✓	✓	✓	✓
/STANDARD=V3	✓	P	P	P
18-digit intermediates	✓	✓	✓	✓
31-digit user items	N	✓	✓	✓
32-digit intermediates	N	✓	✓	✓
64-bit pointers	N	P	P	✓
ACCEPT/DISPLAY BLINK	✓	✓	✓	✓
ACCEPT/DISPLAY WITH CONVERSION	✓	✓	✓	✓
ACCEPT/DISPLAY, extended	✓	✓	✓	✓

(continued on next page)

<sup>1</sup> Because this appendix is comparative and full of system-specific information, the diamond (◆) that elsewhere in the manual signals the end of system-specific sections is not used here except once, at the end of the appendix.

# HP COBOL on Four Platforms: Compatibility and Migration

## B.1 Compatibility Matrix

**Table B-1 (Cont.) Cross-Platform Compatibility of COBOL Features**

	OpenVMS VAX	OpenVMS Alpha	OpenVMS I64	Tru64 UNIX
ACCEPT support for four-digit years	✓	✓	✓	✓
Alignment: Alpha natural, and padding	N	✓	✓	✓
Alignment: VAX compatible	✓	✓	✓	✓
ANSI-74 FILE STATUS support	✓	✓	✓	✓
ANSI-85 REPORT WRITER	✓	✓	✓	✓
ANSI-85/-89/-93 HIGH	✓	✓	✓	✓
Arithmetic, standard	N	P	P	P
CALL USING BY DESCRIPTOR	✓	✓	✓	N
CURRENCY SIGN, enhanced	N	✓	✓	✓
Floating point: "E" literal	✓	✓	✓	✓
Floating point: F,D floating	✓	✓	✓	N
Floating point: G floating	N	✓	✓	N
Floating point: IEEE S,T floating	N	✓	✓	✓
FUNCTION ARGCOUNT	✓	✓	✓	N
Internationalization (PIC N, etc.)	✓	✓	✓	✓
Invalid decimal data checking	P	P	P	P
ISAM key checking	✓	✓	✓	✓
ISAM keys, segmented	✓	✓	✓	✓
ISAM READ PRIOR/START LESS	N	✓	✓	✓
Little-endian COMP data	✓	✓	✓	✓
Locking: UCX/NFS support (nolocking)	N	N	N	✓
Locking: file sharing and record locking	✓	✓	✓	✓
Oracle CDD/DML support	✓	✓	✓	N
Reformat	✓	✓	✓	✓
RMS special registers	✓	✓	✓	N
Symbolic debugger support	✓	✓	✓	✓
SYS\$CURRENCY	✓	✓	✓	N
Table sort	N	✓	✓	✓
Tape handling	✓	✓	✓	✓
Terminal source format	✓	✓	✓	✓
Tools:				
DECset PCA, LSE/SCA support	✓	✓	✓	N
DECset PDF support	✓	N	N	N
FUSE support	N	N	N	✓
Transarc Encina (-tps) support	N	N	N	✓
VFC, print control files with	✓	✓	✓	N
VFC, print control files without	N	✓	✓	✓

(continued on next page)

# HP COBOL on Four Platforms: Compatibility and Migration

## B.1 Compatibility Matrix

**Table B-1 (Cont.) Cross-Platform Compatibility of COBOL Features**

	OpenVMS VAX	OpenVMS Alpha	OpenVMS I64	Tru64 UNIX
X/Open	N	P	P	P
ASSIGN TO	N	✓	✓	✓
Command line	N	✓	✓	✓
COMP-5/COMP-X	N	✓	✓	✓
DISPLAY ON EXCEPTION	N	✓	✓	✓
Environment variables	N	✓	✓	✓
File sharing / record locking	N	✓	✓	✓
LINE SEQUENTIAL	N	✓	✓	✓
RETURN-CODE	N	✓	✓	✓
SCREEN SECTION	N	✓	✓	✓
Y2K intrinsic functions	✓	✓	✓	✓

## B.2 Differences in Extensions and Other Features

HP COBOL on Alpha and I64 contains the following language extensions and other features that are not in HP COBOL on VAX:

- A choice of alignment (with the /ALIGNMENT qualifier or -align flag) on the compile command line or as a source directive for individual records; you can select Alpha data alignment for performance or VAX data alignment for compatibility.
- A qualifier or flag (/ARCHITECTURE or -arch) that enhances performance through targeted code generation.
- A qualifier or flag (/ARITHMETIC or -arithmetic) that selects native or standard arithmetic.
- A qualifier or flag (/CONVERT=LEADING\_BLANKS or -convert leading\_blanks) that changes all blanks to zeros in numeric display items in arithmetic expressions or statements.
- A qualifier or flag (/DISPLAY\_FORMATTED or -display\_formatted) that causes the proper display of numeric values without the use of WITH CONVERSION on the DISPLAY statement.
- A qualifier (/FLOAT) on OpenVMS Alpha that selects IEEE or VAX floating-point data types for single- and double-precision data items.  
On Tru64 UNIX, only IEEE floating point is supported.  
On OpenVMS I64, only IEEE floating point is supported.
- A qualifier or flag (/INCLUDE or -include) to control where the compiler searches for files for simple COPY statements.
- A qualifier or flag (/MATH\_INTERMEDIATE or -math\_intermediate) to specify the intermediate data type for extended arithmetic precision and/or compatibility.

# HP COBOL on Four Platforms: Compatibility and Migration

## B.2 Differences in Extensions and Other Features

- A qualifier or flag (/OPTIMIZE=TUNE or -tune) that improves optimization through instruction scheduling, and a choice of levels of optimization (with /OPTIMIZE=LEVEL or -On.)
- A qualifier or flag (/RESERVED\_WORDS or -rsv) to recognize or not to recognize additional COBOL reserved words defined by the *X/Open Portability Guide*, words that are foreign extensions, or selected words that are reserved as defined by the draft ANSI Standard for COBOL.
- A qualifier (/TIE) on OpenVMS I64 to generate code that allows native OpenVMS I64 images to call translated Alpha images and translated Alpha images to call native OpenVMS I64 images.
- COMP-5 and COMP-X as synonyms for COMP.
- READ PRIOR and START LESS.
- X/Open ASSIGN TO, LINE SEQUENTIAL, RETURN-CODE, SCREEN SECTION, FILE-SHARING, and RECORD-LOCKING.

HP COBOL on Alpha and I64 does not contain the following VAX features:

- The DECset/LSE Program Design Facility, the /DESIGN qualifier, design comments, or pseudocode placeholders.

HP COBOL on Alpha and I64 includes the following:

- Support for the relevant subset of the features in the HP COBOL on VAX /STANDARD=V3 qualifier. See Section B.3.3.
- Support for file status values that are compatible with HP COBOL for OpenVMS VAX Version 5.1 or higher. These differ from those of Version 5.0 and previous versions.

## B.3 Command-Line Qualifiers (Options or Flags)

Sections B.3.1, B.3.2, and B.3.3 compare the HP COBOL command-line qualifiers and flags on the four operating systems. For more information about HP COBOL command-line qualifiers on the OpenVMS Alpha, I64, or VAX operating systems, invoke the online help facility: Type HELP COBOL at the OpenVMS system prompt. For more information on the flags, refer to the man page: Type man cobol at the Tru64 UNIX system prompt.

### B.3.1 Qualifiers and Flags Shared by HP COBOL on Alpha, I64, and VAX

Table B-2 lists the OpenVMS command-line qualifiers shared by HP COBOL on the Alpha, I64, and VAX platforms and the equivalent flags on Tru64 UNIX.

**Table B-2 Qualifiers Shared by HP COBOL for OpenVMS Alpha, I64, and VAX and Equivalent Tru64 UNIX Flags and Options**

OpenVMS Qualifier	Equivalent Tru64 UNIX Flag <sup>1</sup>
/ANALYSIS_DATA	None
/ANSI_FORMAT	-ansi

<sup>1</sup>The flags are generally equivalent in features to the qualifiers, except that flags do not have a negative form.

(continued on next page)

## HP COBOL on Four Platforms: Compatibility and Migration

### B.3 Command-Line Qualifiers (Options or Flags)

**Table B–2 (Cont.) Qualifiers Shared by HP COBOL for OpenVMS Alpha, I64, and VAX and Equivalent Tru64 UNIX Flags and Options**

OpenVMS Qualifier	Equivalent Tru64 UNIX Flag <sup>1</sup>
/AUDIT	None
/CHECK <sup>2</sup>	-check
/CONDITIONALS	-conditionals
/COPY_LIST	-copy_list
/CROSS_REFERENCE	-cross_reference
/DEBUG	-g
/DEPENDENCY_DATA	None
/DIAGNOSTICS	None
/FIPS <sup>2</sup>	-fips 74
/FLAGGER	-flagger
/LIST	-list
/MACHINE_CODE	-machine_code
/MAP	-map
/NATIONALITY={JAPAN   US}	-nationality {japan us}
/OBJECT	None
/SEQUENCE_CHECK	-sequence_check
/STANDARD <sup>2</sup>	-std
/STANDARD=MIA	-std mia
/TRUNCATE	-trunc
/WARNINGS	-warn

<sup>1</sup>The flags are generally equivalent in features to the qualifiers, except that flags do not have a negative form.

<sup>2</sup>There are some differences in behavior and features between HP COBOL on Alpha, I64, and VAX. See the specific documentation for details.

#### **/NATIONALITY={JAPAN | US}, -nationality japan**

When /NATIONALITY=JAPAN or -nationality japan is specified, the yen sign (¥) is the default currency sign and symbol, and Japanese Language Support features are enabled. Also, in this case /NODIAGNOSTICS and /NOANALYSIS\_DATA are specified implicitly.

Oracle CDD/Repository is not supported when /NATIONALITY=JAPAN is used.

When /NATIONALITY=US or -nationality us is specified on the compile command line, the dollar sign (\$) is the default currency sign and symbol, and Japanese Language Support features are disabled.

#### **/STANDARD=MIA, -std mia**

If /STANDARD=MIA or -std mia are present on the compile command line, the compiler will issue informational diagnostics for those language elements that do not conform to the MIA specifications:

- Hewlett-Packard syntax extension from Base Standards (ANSI-85, JIS-88)
- Two of four optional modules
- All obsolete language elements of required modules in Base Standards

## HP COBOL on Four Platforms: Compatibility and Migration

### B.3 Command-Line Qualifiers (Options or Flags)

- Language elements omitted from required modules in Base Standards because of the different implementation of the vendors
- HP-specific Japanese features out of MIA Extension Elements related to Japanese

To receive the diagnostics, the `-warn all` flag, `/WARNINGS=ALL` qualifier, `-warn information` flag, or `/WARNING=INFORMATION` qualifier is required.

The default is NOMIA.

#### B.3.2 Alpha- and I64-Specific COBOL Qualifiers and Flags

Table B–3 lists the command-line qualifiers and flags for features specific to HP COBOL on Alpha and I64 and not available on VAX.

**Table B–3 HP COBOL on Alpha and I64 Options Not Available on VAX**

OpenVMS Alpha and I64 Qualifier	Tru64 UNIX Flag
/ALIGNMENT	-align
/ARCHITECTURE= <i>keyword</i>	-arch <i>keyword</i>
/ARITHMETIC=NATIVE	-arithmetic native
/ARITHMETIC=STANDARD	-arithmetic standard
No equivalent qualifier	-c
No equivalent qualifier	-call_shared
/CHECK=DECIMAL	-check decimal
/CONVERT=LEADING_BLANKS	-convert leading_blanks
No equivalent qualifier	-cord
No equivalent qualifier	-D <i>num</i>
/DISPLAY_FORMATTED	-display_formatted
No equivalent qualifier	-feedback <i>file</i>
/FLOAT=D_FLOAT (Alpha default)	No equivalent flag
/FLOAT=G_FLOAT	No equivalent flag
/FLOAT=IEEE_FLOAT (I64 default)	No equivalent flag
/GRANULARITY= <i>keyword</i>	-granularity <i>keyword</i>
/INCLUDE	-include
No equivalent qualifier	-K
No equivalent qualifier	-L
No equivalent qualifier	-Ldir
No equivalent qualifier	-lstring
/MATH_INTERMEDIATE=CIT3	-math_intermediate cit3
/MATH_INTERMEDIATE=CIT4	-math_intermediate cit4
/MATH_INTERMEDIATE=FLOAT	-math_intermediate float
No equivalent qualifier	-names as_is
No equivalent qualifier	-names lowercase
No equivalent qualifier	-names uppercase

(continued on next page)



## HP COBOL on Four Platforms: Compatibility and Migration

### B.3 Command-Line Qualifiers (Options or Flags)

**Table B–3 (Cont.) HP COBOL on Alpha and I64 Options Not Available on VAX**

OpenVMS Alpha and I64 Qualifier	Tru64 UNIX Flag
No equivalent qualifier	-nolocking
No equivalent qualifier	-non_shared
/OPTIMIZE=LEVEL= <i>n</i>	-O <i>n</i>
No equivalent qualifier	-p[ <i>n</i> ]
No equivalent qualifier	-relax_key_checking
/RESERVED_WORDS=[NO]200X	-rsv [no]200x
/RESERVED_WORDS=[NO]FOREIGN_EXTENSIONS	-rsv [no]foreign_extensions
/RESERVED_WORDS=[NO]XOPEN	-rsv [no]xopen
No equivalent qualifier	-shared
No equivalent qualifier	-T [ <i>num</i> ]
No equivalent qualifier	-taso
/TIE	No equivalent flag
No equivalent qualifier	-tps
/OPTIMIZE=TUNE= <i>keyword</i>	-tune <i>keyword</i>
No equivalent qualifier	-V
No equivalent qualifier	-v
No equivalent qualifier	-xref,-xref_stdout

#### **/ALIGNMENT=Padding, -align padding**

The *HP OpenVMS Calling Standard* requires that data fields be aligned on specific addresses (shown in those standards). The same standards specify that the lengths of all data records and group data items must be multiples of their alignments.

If /ALIGNMENT=Padding or -align padding is present on the compile command line, COBOL group data-items will be aligned on their natural boundaries and those group items will be padded out to multiples of their alignments. Refer to the *HP COBOL Reference Manual* for detailed information about elementary data item alignment with Alpha alignment and padding in effect.

### **B.3.3 Qualifiers Only on HP COBOL for OpenVMS VAX**

Table B–4 lists the command-line qualifiers and qualifier-option combinations that are specific to HP COBOL on VAX. Except as noted, these qualifiers have no equivalents on Alpha or I64 systems.

**Table B–4 HP COBOL for OpenVMS VAX Specific Qualifiers**

Qualifier	Comments
/DESIGN	Controls whether the compiler processes the input file as a detailed design.

(continued on next page)

# HP COBOL on Four Platforms: Compatibility and Migration

## B.3 Command-Line Qualifiers (Options or Flags)

**Table B–4 (Cont.) HP COBOL for OpenVMS VAX Specific Qualifiers**

Qualifier	Comments
<code>/INSTRUCTION_SET[=option]</code>	Improves run-time performance on single-chip VAX processors, using different portions of the VAX instruction set.
<code>/STANDARD=OPENVMS_AXP</code>	Produces informational messages on language features that are not supported by the HP COBOL compiler on Alpha or I64. (See the section on <code>/STANDARD=OPENVMS_AXP</code> in this appendix, and refer to the HP COBOL for OpenVMS VAX release notes.)
<code>/STANDARD=PDP11</code>	Produces informational messages on language features that are not supported by the COBOL-81 compiler.
<code>/WARNINGS=STANDARD</code>	Produces informational messages on language features that are HP extensions. The HP COBOL equivalent on Alpha and I64 is the <code>/STANDARD=SYNTAX</code> qualifier or the <code>-std syntax</code> flag.

### **`/STANDARD=V3, -std v3`**

HP COBOL on Alpha and I64 does not support a number of features supported by the implementation of the `/STANDARD=V3` qualifier on VAX, as follows:

- When subscripts are evaluated in `STRING`, `UNSTRING`, and `INSPECT (Format 3)` statements and the `REMAINDER` phrase of the `DIVIDE` statement
- When reference modification is evaluated in `STRING`, `UNSTRING`, and `INSPECT (Format 3)` statements
- When an out-of-range expression specifying the starting position or length of reference modification is detected; HP COBOL on Alpha and I64 detects the out-of-range expression at run time (if `/CHECK=BOUNDS` is used), whereas HP COBOL on VAX in some cases detects it at compile time
- When the variable associated with the `VARYING` phrase is augmented in `PERFORM . . . VARYING . . . AFTER` statements (Format 4)
- How PIC P digits are interpreted in some moves
- When the size of variable-length tables (`OCCURS DEPENDING ON`) is determined in the `MOVE` statement

The `/WARNINGS=ALL` qualifier or the `-warn all` flag can help you determine the effects of `/STANDARD=V3` and `-std v3`; in particular, the HP COBOL compiler on Alpha and I64 will generate the following informational messages if `/STANDARD=V3` or `-std v3` has been specified:

- For items that may be affected by evaluation order in the `INSPECT`, `STRING`, `UNSTRING`, and `DIVIDE` statements:  
`/STANDARD=V3 evaluation order not supported for this construct`
- For destinations where `OCCURS DEPENDING ON` requires different behavior in the `MOVE` statement:  
`/STANDARD=V3 variable length item rules not supported for this construct`

## HP COBOL on Four Platforms: Compatibility and Migration

### B.3 Command-Line Qualifiers (Options or Flags)

For full information on the differences in the HP COBOL for OpenVMS Alpha or the OpenVMS I64 implementation of the /STANDARD=V3 qualifier, refer to the online help.

#### **/STANDARD=OPENVMS\_AXP**

HP COBOL for OpenVMS VAX Version 5.1 (and higher) provides a flagging system, via the /STANDARD=OPENVMS\_AXP qualifier option, to identify language features in your existing programs that are not available in HP COBOL on the OpenVMS Alpha system. (There may be additional language features not available on the Tru64 UNIX system.)

When you specify /STANDARD=OPENVMS\_AXP, the HP COBOL for OpenVMS VAX compiler generates informational messages to alert you to language constructs that are not available in HP COBOL on OpenVMS Alpha or OpenVMS I64. (You must also specify /WARNINGS=ALL or /WARNINGS=INFORMATIONAL to receive these messages.) You can use this information to modify your program.

Specify /STANDARD=NOOPENVMS\_AXP, which is the default, to suppress these informational messages.

## B.4 HP COBOL Behavior Differences on VAX and Alpha and I64

This section describes behavior differences between HP COBOL on its Alpha and I64 and VAX platforms.

### B.4.1 Program Structure Messages

In some cases, the HP COBOL compiler (whether on the OpenVMS Alpha, OpenVMS I64, or the Tru64 UNIX system) generates more complete messages about unreachable code or other logic errors than does the HP COBOL for OpenVMS VAX compiler.

The following example illustrates a sample program and the messages issued, or not issued, by the HP COBOL compiler on each of the three platforms:

#### **Source file**

```
IDENTIFICATION DIVISION.  
PROGRAM-ID. T1.  
ENVIRONMENT DIVISION.  
PROCEDURE DIVISION.  
P0.  
    GO TO P1.  
P2.  
    DISPLAY "This is unreachable code".  
P1.  
    STOP RUN.
```

#### **On OpenVMS VAX systems**

```
$ COBOL /ANSI/WARNINGS=ALL T1.COB  
$
```

The program compiles. The HP COBOL for OpenVMS VAX compiler produces no messages.

#### **On OpenVMS Alpha and I64 systems**

```
$ COBOL/ANSI/OPTIMIZE/WARNINGS=ALL T1.COB  
      P2.  
      ^  
.....  
%COBOL-I-UNREACH, code can never be executed at label P2  
at line number 7 in file DISK$YOURDISK:[TESTDIR]T1.COB;1
```

# HP COBOL on Four Platforms: Compatibility and Migration

## B.4 HP COBOL Behavior Differences on VAX and Alpha and I64

### On Tru64 UNIX systems

```
% cobol -ansi -O -warn all T1.COB
cobol: Info: T1.COB, line 7: code can never be executed at label P2
      P2
-----^
```

HP COBOL on either Alpha platform, or on I64 is an optimizing compiler. One use of optimization is to perform analysis for uncalled routines and unreachable paragraphs. The compiler performs the unreachable code analysis for all levels of optimization, including /NOOPTIMIZE or the equivalent -O0 flag. HP COBOL for OpenVMS VAX does not have an /OPTIMIZE qualifier.

### B.4.2 Program Listing Differences

Some differences appear in program listings depending upon whether they were produced by the HP COBOL compiler on OpenVMS Alpha, OpenVMS I64, OpenVMS VAX, or Tru64 UNIX.

#### B.4.2.1 Machine Code

With HP COBOL on Alpha and I64, /NOOBJECT and -noobject cause the compiler to suppress code generation, so no machine code is produced either for the listing or for the object module.

If you want the machine code to be included in the program listing, do not use /NOOBJECT or -noobject.

On VAX, /NOOBJECT suppresses just the creation of the .OBJ file. The compiler still does all the work to generate the object code so it can be placed in the listing.

#### B.4.2.2 Module Names

With HP COBOL on Alpha and I64, the name of the first program is the module name throughout the compilation. On VAX, the module name changes as the various programs are encountered.

#### B.4.2.3 COPY and REPLACE Statements

The HP COBOL compiler produces output in slightly different formats on Alpha and I64 and VAX when listing annotations for the COPY statement in COBOL programs.

The following two compiler listing files illustrate the difference in the position of the listing annotations, represented by the letter "L":

#### HP COBOL on Alpha and I64 Listing File for COPY Statement

```
1 IDENTIFICATION DIVISION.
2 PROGRAM-ID. DCOPIB.
3 *
4 *          This program tests the copy library file.
5 *          with a comment in the middle of it.
6 *          It should not produce any diagnostics.
7          COPY
8 *          this is the comment in the middle
9          LCOPIA.
L          10 ENVIRONMENT DIVISION.
```

## HP COBOL on Four Platforms: Compatibility and Migration

### B.4 HP COBOL Behavior Differences on VAX and Alpha and I64

```
L          11 INPUT-OUTPUT SECTION.  
L          12 FILE-CONTROL.  
L          13 SELECT FILE-1  
L          14          ASSIGN TO "FILE1.TMP".  
          15 DATA DIVISION.  
          16 FILE SECTION.  
          17 FD          FILE-1.  
          18 01          FILE1-REC          PIC X.  
          19 WORKING-STORAGE SECTION.  
          20 PROCEDURE DIVISION.  
          21 PE.          DISPLAY "***END***"  
          22          STOP RUN.
```

#### HP COBOL on VAX Listing File for COPY Statement

```
1          IDENTIFICATION DIVISION.  
2          PROGRAM-ID. DCOPIB.  
3          *  
4          * This program tests the copy library file.  
5          * with a comment in the middle of it.  
6          * It should not produce any diagnostics.  
7          COPY  
8          * this is the comment in the middle  
9          LCOPIA.  
10L        ENVIRONMENT DIVISION.  
11L        INPUT-OUTPUT SECTION.  
12L        FILE-CONTROL.  
13L        SELECT FILE-1  
14L        ASSIGN TO "FILE1.TMP".  
15        DATA DIVISION.  
16        FILE SECTION.  
17        FD FILE-1.  
18        01 FILE1-REC          PIC X.  
19        WORKING-STORAGE SECTION.  
20        PROCEDURE DIVISION.  
21        PE. DISPLAY "***END***"  
22        STOP RUN.
```

#### B.4.2.4 Multiple COPY Statements

The HP COBOL compiler also produces output in slightly different formats on Alpha and I64 and VAX when listing a COBOL program with multiple COPY statements on a single line.

The following two compiler listing files illustrate the difference in the position of the listing annotations, represented by the letter "L," for multiple COPY statements on a single line:

# HP COBOL on Four Platforms: Compatibility and Migration

## B.4 HP COBOL Behavior Differences on VAX and Alpha and I64

### HP COBOL on Alpha and I64 Listing File for Multiple COPY Statements

```
1 IDENTIFICATION DIVISION.
2 PROGRAM-ID. DCOPIJ.
3 *
4 *       Tests copy with three copy statements on 1 line.
5 *
6 ENVIRONMENT DIVISION.
7 DATA DIVISION.
8 PROCEDURE DIVISION.
9 THE.
10      COPY LCOP1J. COPY LCOP1J. COPY LCOP1J.
L 11      DISPLAY "POIUYTREWQ".
L 12      DISPLAY "POIUYTREWQ".
L 13      DISPLAY "POIUYTREWQ".
14      STOP RUN.
```

### HP COBOL on VAX Listing File for Multiple COPY Statements

```
1 IDENTIFICATION DIVISION.
2 PROGRAM-ID. DCOPIJ.
3 *
4 *       Tests copy with three copy statements on 1 line.
5 *
6 ENVIRONMENT DIVISION.
7 DATA DIVISION.
8 PROCEDURE DIVISION.
9 THE.
10      COPY LCOP1J.
11L     DISPLAY "POIUYTREWQ".
12C           COPY LCOP1J.
13L     DISPLAY "POIUYTREWQ".
14C           COPY LCOP1J.
15L     DISPLAY "POIUYTREWQ".
16      STOP RUN.
```

#### B.4.2.5 COPY Insert Statement

The compiler listing file for an HP COBOL program differs on Alpha and I64 from VAX when a COPY statement inserts text in the middle of a line.

In the following two compiler listing files, LCOP5D.LIB contains "O". The HP COBOL on Alpha and I64 compiler keeps the same line and inserts the COPY file contents below the source line. On VAX, the compiler splits the original source line into parts.

### HP COBOL on Alpha and I64 Listing File for COPY Statement

```
-----
13 P0.      MOVE COPY LCOP5D. TO ALPHA.
L 14           "O"
```

### HP COBOL on VAX Listing File for COPY Statement

```
-----
13      P0. MOVE COPY LCOP5D.
14L           "O"
15C           TO ALPHA.
```

# HP COBOL on Four Platforms: Compatibility and Migration

## B.4 HP COBOL Behavior Differences on VAX and Alpha and I64

### B.4.2.6 REPLACE and COPY REPLACING Statements

For the REPLACE and COPY REPLACING statements, the line numbers in compiler listing files differ between Alpha and I64 listing files and VAX listing files. HP COBOL on Alpha and I64 arranges the line number for the replacement line to correspond to its line number in the original source text, while subsequent line numbers differ. HP COBOL for OpenVMS VAX arranges the line numbers consecutively.

The following source program produces compiler listing files with different ending line numbers on Alpha and I64 and VAX:

#### Source File

```
REPLACE ==A VERY LONG STATEMENT== by ==EXIT PROGRAM==.
A
VERY
LONG
STATEMENT.
DISPLAY "To REPLACE or not to REPLACE".
```

#### HP COBOL on Alpha and I64 Listing File for REPLACE Statement

```
-----
1 REPLACE ==A VERY LONG STATEMENT== by ==EXIT PROGRAM==.
2 EXIT PROGRAM.
6 DISPLAY "To REPLACE or not to REPLACE".
```

#### HP COBOL on VAX Listing File for REPLACE Statement

```
-----
1 REPLACE ==A VERY LONG STATEMENT== by ==EXIT PROGRAM==.
2 EXIT PROGRAM.
3 DISPLAY "To REPLACE or not to REPLACE".
```

The diagnostic messages for the COBOL source statements REPLACE and DATE-COMPILED result in compiler listing files that contain multiple instances of the source line.

On Alpha and I64, for a REPLACE statement in an HP COBOL program, if the compiler issues a message on the replacement text, the message corresponds to the original text in the program, as shown in the following:

#### HP COBOL on Alpha and I64 Listing File for REPLACE Statement

```
18 P0.    REPLACE ==xyzpdqnothere==
19                BY ==nothere==.
20
21                copy "drep3hlib".
L           22                display xyzpdqnothere.
                .....1
                %COBOL-F-UNDEFSYM, (1) Undefined name
LR          22                display nothere.
```

On VAX, the compiler message corresponds to the replacement text, as shown in the following:

## HP COBOL on Four Platforms: Compatibility and Migration

### B.4 HP COBOL Behavior Differences on VAX and Alpha and I64

#### HP COBOL on VAX Listing File for REPLACE Statement

```
18          P0. REPLACE ==xyzpdqnothere==
19                      BY ==nothere==.
20
21          copy "drep3hlib".
22LR        display nothere.
           1
%COBOL-F-ERROR 349, (1) Undefined name
```

#### B.4.2.7 DATE COMPILED Statement

The following two compiler listing files demonstrate the difference between using the DATE-COMPILED statement with HP COBOL on Alpha or I64 and VAX.

#### HP COBOL on Alpha and I64 Listing File for DATE-COMPILED Statement

```
33 *
34 date-compiled
   .....1
%COBOL-E-NODOT, (1) Missing period is assumed
34 date-compiled 16-Jul-1992.
35 security. none.
```

#### HP COBOL on VAX Listing File for DATE-COMPILED Statement

```
33 *
34 date-compiled 16-Jul-1992.
           1
%COBOL-E-ERROR 65, (1) Missing period is assumed
35 security. none.
```

#### B.4.2.8 Compiler Listings and Separate Compilations (OpenVMS)

On OpenVMS Alpha and I64, the /SEPARATE\_COMPILATION qualifier produces distinct listings. For separately compiled programs (SCP) compiled *without* /SEPARATE\_COMPILATION, the listings are ordered as follows:

- PROGRAM\_1 source listing
- PROGRAM\_2 source listing
- PROGRAM\_3 source listing
- PROGRAM\_1 machine code listing
- PROGRAM\_2 machine code listing
- PROGRAM\_3 machine code listing

With /SEPARATE\_COMPILATION, the listings are ordered as follows (consistent with the order on VAX):

- PROGRAM\_1 source listing
- PROGRAM\_1 machine code listing
- PROGRAM\_2 source listing
- PROGRAM\_2 machine code listing
- PROGRAM\_3 source listing
- PROGRAM\_3 machine code listing



# HP COBOL on Four Platforms: Compatibility and Migration

## B.4 HP COBOL Behavior Differences on VAX and Alpha and I64

### B.4.3 Output Formatting

#### Control Byte Sequences

HP COBOL on Alpha and I64 and HP COBOL on VAX may use different control byte sequences in VFC files to accomplish similar output file formatting.

#### VFC Files

VFC formatted REPORT WRITER or LINAGE files are normally viewed by using the TYPE command or by printing them out. If you need to mail reports through electronic mail or to bring them up in an editor, you can do so by compiling with /NOVFC on the compile command line.

All REPORT WRITER and LINAGE files that are opened in a single .COB source file will have the same format (either VFC or NOVFC). VFC is the default. For example:

```
$ COBOL A/NOVFC,B/VFC,C/NOVFC,D
```

In this example, source files B and D will produce reports in VFC format. (Behavior is different when the source file list items are separated by plus (+) signs. See Section 1.2.2.1, Format of the COBOL Command on OpenVMS.)

On Tru64 UNIX, the REPORT WRITER and LINAGE files produce ASCII file output, which can be viewed or mailed electronically.

### B.4.4 HP COBOL Statement Differences on Alpha, I64, and VAX

The following COBOL statements and clause behave differently on Alpha and I64 than they do on VAX:

- ACCEPT
- DISPLAY
- EXIT PROGRAM
- LINAGE clause
- MOVE
- SEARCH

#### B.4.4.1 ACCEPT and DISPLAY Statements

When you use any extended feature of ACCEPT or DISPLAY within your program, visible differences in behavior between HP COBOL on Alpha and I64 and VAX exist in some instances. The Alpha and I64 behavior in these instances is as follows:

- When you mix ANSI ACCEPT statements and extended ACCEPT statements in a program, the editing keys used by the extended ACCEPT statements are also used by the ANSI ACCEPT statements. (See Table 11–3 for a complete list of editing keys.)
- When your terminal is set to no-wrap mode and you display an item whose characters extend past the edge of the screen, all characters past the rightmost column are truncated. For example, if you specify a display of “1234” at column 79 on an 80-column screen, HP COBOL on Alpha and I64 will display 12. By contrast, HP COBOL on VAX overstrikes the character in the rightmost column and displays 14.

## HP COBOL on Four Platforms: Compatibility and Migration

### B.4 HP COBOL Behavior Differences on VAX and Alpha and I64

- If your application uses the HP extensions to the ACCEPT or DISPLAY statements, HP COBOL on Alpha and I64 positions the cursor in the upper left corner of the screen prior to the execution of the first ACCEPT or DISPLAY statement.

This difference is clearly shown when the first ACCEPT or DISPLAY statement does not contain the LINE and COLUMN clauses. In this case HP COBOL on Alpha and I64 moves the cursor to the top of the screen to perform the ACCEPT or DISPLAY, whereas HP COBOL on VAX does not move the cursor.

Screen update behavior is not identical for HP COBOL on Alpha and I64 and HP COBOL on VAX, and they sometimes use different escape sequences for ACCEPT and DISPLAY to accomplish similar screen formatting.

If you attempt to use extended ACCEPT/DISPLAY with input redirected from a file or output redirected to a file, the operation differs between HP COBOL on VAX and HP COBOL on Alpha and I64. In general, on Alpha and I64, the HP COBOL RTL attempts to use ANSI ACCEPT/DISPLAY to handle all ACCEPT and DISPLAY statements in this situation. For example, if you use DISPLAY AT LINE or ACCEPT DEFAULT, the RTL will ignore the extensions (that is, LINE or DEFAULT) if you redirect output to a file or input from a file. On VAX, the RTL ignores some, but not all, ACCEPT/DISPLAY extensions when input is redirected from a file or output is redirected to a file.

#### **END-DISPLAY Difference**

In HP COBOL on Alpha and I64, a DISPLAY statement in an ON EXCEPTION for an ACCEPT statement must be terminated, with, for example, END-DISPLAY. END-DISPLAY is supported for all formats of DISPLAY on Alpha and I64.

In HP COBOL on VAX, END-DISPLAY is not supported. If you convert code with ACCEPT ON EXCEPTION to handle DISPLAY on VAX and also on Alpha and I64, you need to PERFORM a paragraph with the DISPLAY from the ON EXCEPTION processing in the ACCEPT.

For more information about ACCEPT and DISPLAY, including sample programs, see Chapter 11, Using ACCEPT and DISPLAY Statements for Input/Output and Video Forms.

#### **B.4.4.2 LINAGE Clause**

HP COBOL on Alpha and I64 and HP COBOL on VAX exhibit different behavior when handling large values for the LINAGE clause. If the line count for the ADVANCING clause of the WRITE statement is larger than 127, HP COBOL on Alpha and I64 advances one line, whereas VAX results are undefined.

#### **B.4.4.3 MOVE Statement**

Unsigned computational fields can hold larger values than signed computational fields. In accordance with the ANSI COBOL Standard, the values for unsigned items should always be treated as positive. HP COBOL on VAX, however, treats unsigned items as signed, while HP COBOL on Alpha and I64 treats them as positive. Therefore, in some rare cases, a mixture of unsigned and signed data items in MOVE or arithmetic statements can produce different results between HP COBOL on VAX and HP COBOL on Alpha and I64.

Example B-1 produces different results for HP COBOL for OpenVMS VAX and HP COBOL on Alpha and I64.

# HP COBOL on Four Platforms: Compatibility and Migration

## B.4 HP COBOL Behavior Differences on VAX and Alpha and I64

### Example B-1 Signed and Unsigned Differences

```
IDENTIFICATION DIVISION.  
PROGRAM-ID. SHOW-DIFF.  
ENVIRONMENT DIVISION.  
DATA DIVISION.  
WORKING-STORAGE SECTION.  
01 A2          PIC 99    COMP.  
01 B1          PIC S9(5) COMP.  
01 B2          PIC 9(5)  COMP.  
PROCEDURE DIVISION.  
TEST-1.  
    MOVE 65535 TO A2.  
    MOVE A2 TO B1.  
    DISPLAY B1 WITH CONVERSION.  
    MOVE A2 TO B2.  
    DISPLAY B2 WITH CONVERSION.  
STOP RUN.
```

#### VAX Results

```
B1 = -1  
B2 = -1
```

#### Alpha and I64 Results

```
B1 = 65535  
B2 = 65535
```

#### B.4.4.4 SEARCH Statement

In HP COBOL on Alpha and I64 and in HP COBOL on VAX Version 5.0 and higher, the END-SEARCH and NEXT SENTENCE phrases are mutually incompatible in a SEARCH statement. If you use one, you must not use the other. This rule, which complies with the ANSI COBOL Standard, does not apply to VAX COBOL versions earlier than Version 5.0.

#### B.4.5 System Return Codes

Example B-2 illustrates an illegal coding practice that exhibits different behavior on Alpha and I64 and VAX. The cause is an architectural difference in the register sets between the VAX and Alpha and I64 architectures: on Alpha and I64, there are separate sets of registers for floating-point data types.

The bad coding practice exhibited in Example B-2 can impact OpenVMS Alpha, OpenVMS I64, and Tru64 UNIX systems and any supported Alpha or I64 floating-point data type.

# HP COBOL on Four Platforms: Compatibility and Migration

## B.4 HP COBOL Behavior Differences on VAX and Alpha and I64

### Example B-2 Illegal Return Value Coding

```
IDENTIFICATION DIVISION.
PROGRAM-ID. BADCODING.
ENVIRONMENT DIVISION.
DATA DIVISION.
FILE SECTION.
WORKING-STORAGE SECTION.
    01 FIELDS-NEEDED.
        05 CYCLE-LOGICAL          PIC X(14) VALUE 'A_LOGICAL_NAME'.
    01 EDIT-PARM.
        05 EDIT-YR                PIC X(4).
        05 EDIT-MO                PIC XX.
    01 CMR-RETURN-CODE           COMP-1 VALUE 0.
LINKAGE SECTION.
    01 PARM-REC.
        05 CYCLE-PARM            PIC X(6).
        05 MY-RETURN-CODE        COMP-1 VALUE 0.
PROCEDURE DIVISION USING PARM-REC GIVING CMR-RETURN-CODE.
P0-CONTROL.
    CALL 'LIB$SYS_TRNLOG' USING BY DESCRIPTOR CYCLE-LOGICAL,
                                OMITTED,
                                BY DESCRIPTOR CYCLE-PARM
                                GIVING MY-RETURN-CODE.

    IF MY-RETURN-CODE GREATER 0
        THEN
            MOVE MY-RETURN-CODE TO CMR-RETURN-CODE
            GO TO P0-EXIT.
    MOVE CYCLE-PARM TO EDIT-PARM.
    IF EDIT-YR NOT NUMERIC
        THEN
            MOVE 4 TO CMR-RETURN-CODE, MY-RETURN-CODE.
    IF EDIT-MO NOT NUMERIC
        THEN
            MOVE 4 TO CMR-RETURN-CODE, MY-RETURN-CODE.
    IF CMR-RETURN-CODE GREATER 0
        OR
        MY-RETURN-CODE GREATER 0
        THEN
            DISPLAY "*****"
            DISPLAY "** BADCODING.COB **"
            DISPLAY "** A_LOGICAL_NAME> ", CYCLE-PARM, "   **"
            DISPLAY "*****".
P0-EXIT.
    EXIT PROGRAM.
```

In Example B-2, the programmer incorrectly defined the return value for a system service call to be F\_floating when it should have been binary (COMP). The programmer was depending on the following VAX behavior: in the VAX architecture, all return values from routines are returned in register R0. The VAX architecture has no separate integer and floating-point registers. The Alpha and Itanium® architectures define separate register sets for floating-point and binary data. Routines that return floating-point values return them in a register other than R0; routines that return binary values return them in register R0.

The HP COBOL on Alpha and I64 compilers have no method for determining what data type an external routine may return. You must specify the correct data type for the GIVING-VALUE item in the CALL statement. On the Alpha and Itanium® architectures, the generated code is testing a register other than R0 because of the different set of registers used for floating-point data items.

## HP COBOL on Four Platforms: Compatibility and Migration

### B.4 HP COBOL Behavior Differences on VAX and Alpha and I64

In the sample program, the value in F0 is unpredictable in this code sequence. In some cases, this coding practice may produce the expected behavior, but in most cases it will not.

#### B.4.6 Diagnostic Messages

Several diagnostic messages have different meanings and results depending on the platform, as follows:

- HP COBOL on Alpha and I64 does not perform the same run-time error recovery behavior as HP COBOL on VAX upon receipt of the following diagnostic:

```
%COBOL-E-EXITDECL, EXIT PROGRAM statement invalid in GLOBAL DECLARATIVE
```

- HP COBOL on VAX always ignores an EXIT PROGRAM in a GLOBAL USE procedure. HP COBOL on Alpha and I64 ignores the EXIT PROGRAM only if the GLOBAL USE is invoked from other than the current program unit.

To produce behavior identical to HP COBOL for OpenVMS VAX, correct the problem causing the diagnostic.

- If one of the operands in a comparison is illegal, causing an error message, HP COBOL on VAX continues analyzing the statement containing the conditional, but HP COBOL on Alpha and I64 skips to the next statement (thus not finding any additional errors in the statement).
- If a source statement contains multiple divides and the divisor(s) are a literal zero, a figurative zero, or a variable whose value is zero, HP COBOL on Alpha and I64 issues a single divide-by-zero run-time diagnostic, while HP COBOL on VAX issues the same diagnostic for each divide-by-zero in the statement. For example, the following code produces three diagnostics with HP COBOL on VAX and only one diagnostic with HP COBOL on Alpha and I64:

```
DIVIDE 0 INTO A, B, C.
```

In accordance with the ANSI COBOL Standard, both compilers allow execution to continue with unpredictable results.

- The HP COBOL RTL on Tru64 UNIX can give a result that differs from OpenVMS Alpha and OpenVMS I64 in the case where your program tries to create an ISAM file with two keys that are the same except for the status of the duplicates (one key specifies DUPLICATES and the other key does not). In this case, on Tru64 UNIX you will receive the following message (if -rkc is not specified):

```
COB S ISAM BADKEY  
ISAM file %s created with two keys that are the same except for  
their acceptance of duplicate values
```

This will be translated into the COBOL status code 39, which is used for a conflict in file attributes.

HP COBOL on OpenVMS Alpha and HP COBOL on OpenVMS I64 do not allow duplicate keys unless directed in both key specifications.

- There is a difference between HP COBOL on VAX and HP COBOL on Alpha and I64 in the enforcement of the general rule that name conflicts should be avoided, including names used for COPY libraries. On VAX, the compiler does not enforce this rule in some cases, including COPY and PROGRAM-ID. Hence a COBOL program that compiles without error on VAX might result in a NAMCLASS error on Alpha and I64, as follows:

## HP COBOL on Four Platforms: Compatibility and Migration

### B.4 HP COBOL Behavior Differences on VAX and Alpha and I64

```
%COBOL-E-NAMCLASS, Multiply defined name - name used in more than one  
user-defined word class at line number . . .
```

To avoid the error, you should either change the conflicting name or make it a literal by putting it in quotation marks, for example:

```
COPY "LIBRARY-FILE" FROM COPYLIB.
```

#### B.4.7 Storage for Double-Precision Data Items

OpenVMS Alpha supports VAX floating-point data types and IEEE floating point data types in hardware. OpenVMS I64 supports IEEE floating-point in hardware and VAX floating-point data types in software.

The OpenVMS I64 compilers provide /FLOAT=D\_FLOAT and /FLOAT=G\_FLOAT qualifiers to enable you to produce VAX floating-point data types. If you do not specify one of these qualifiers, IEEE floating-point data types will be used.

You can test an application's behavior with IEEE floating-point values on Alpha by compiling it with an IEEE qualifier on OpenVMS Alpha. If that produces acceptable results, you can build the application on an I64 system using the same qualifier.

When you compile an OpenVMS application that specifies an option to use VAX floating-point on I64, the compiler automatically generates code for converting floating-point formats. Whenever the application performs a sequence of arithmetic operations, this code does the following:

1. Converts VAX floating-point formats to either IEEE single or IEEE double floating-point formats.
2. Performs arithmetic operations in IEEE floating-point arithmetic.
3. Converts the resulting data from IEEE formats back to VAX formats.

Where no arithmetic operations are performed (VAX float fetches followed by stores), conversions do not occur. The code handles these situations as moves.

In a few cases, arithmetic calculations might have different results because of the following differences between VAX and IEEE formats:

- Values of numbers represented
- Rounding rules
- Exception behavior

On OpenVMS, the difference in storage format of D\_floating items between the VAX and Alpha and I64 architectures produces slightly different answers when validating execution results. The magnitude of the difference depends on how many D-float computations and stores the compiler has performed before outputting the final answer. This behavior difference may cause some difficulty if you attempt to validate output generated by your program running on OpenVMS Alpha and OpenVMS I64 systems against output generated by OpenVMS VAX systems when outputting COMP-2 data to a file.

Only IEEE floating point is available on the Tru64 UNIX operating system.

For information about storage format for floating-point data types, refer to the *Alpha Architecture Reference Manual*, available from Digital Press.

# HP COBOL on Four Platforms: Compatibility and Migration

## B.4 HP COBOL Behavior Differences on VAX and Alpha and I64

### B.4.8 File Status Values

HP COBOL on Alpha and I64 and HP COBOL on VAX return different file status values when you open a file in EXTEND mode and then try to REWRITE it. For this undefined operation, HP COBOL on Alpha and I64 returns File Status 49 (incompatible open mode), while HP COBOL on VAX returns File Status 43 (no previous READ).

### B.4.9 RMS Special Registers (OpenVMS)

There are some differences in the behavior of RMS Special Registers depending on your OpenVMS platform.

#### Loading Differences

At run time, HP COBOL for OpenVMS Alpha and I64 and HP COBOL for OpenVMS VAX update the values for the RMS special registers differently for some I/O operations. On Alpha and I64, the run-time system checks for some I/O error situations before attempting the RMS operation; in those situations, the run-time system does not attempt an RMS operation and the RMS special register retains its previous value. The HP COBOL for OpenVMS VAX run-time system performs all RMS operations without any prior checking of the I/O operation. As a result, the run-time system always updates the values for the RMS special registers for each I/O operation.

For example, on Alpha and I64, in the case of a file that was not successfully opened, any subsequent COBOL record operation (READ, WRITE, START, DELETE, REWRITE, or UNLOCK) fails without invoking RMS. Thus, the values placed in the RMS special registers for the failed OPEN operation remain unchanged for the subsequent failed record operations on the same file. The same subsequent record operations on HP COBOL for OpenVMS VAX always invoke RMS, which attempts the undefined operations and returns new values to the RMS special registers.

There is one other instance when the RMS special registers can contain different values for applications on OpenVMS Alpha and I64 and VAX. On Alpha and I64, upon the successful completion of an RMS operation on a COBOL file, the RMS special registers always contain RMS completion codes. On VAX, upon the successful completion of an RMS operation on a COBOL file, the RMS special registers usually contain RMS completion codes, but occasionally these registers may contain COBOL-specific completion codes.

#### Difference in Rule for Compiler-Generated and User Variables

HP COBOL for OpenVMS Alpha and I64 does not allow the following compiler-generated variables to be declared as user variables, as HP COBOL for OpenVMS VAX does:

```
RMS_STS  
RMS_STV  
RMS_CURRENT_STS  
RMS_CURRENT_STV
```

## HP COBOL on Four Platforms: Compatibility and Migration

### B.4 HP COBOL Behavior Differences on VAX and Alpha and I64

#### B.4.10 Calling Shareable Images

On OpenVMS, HP COBOL exhibits different behavior on Alpha or I64 than it does on VAX when calling a subprogram installed as a shareable image. On Alpha and I64, the program name you specify in a CALL statement can be either a literal or a data-name. (The same is true for the CANCEL statement.) On VAX, the program name you specify in a CALL (or CANCEL) statement must be a literal. In addition, on VAX, HP COBOL programs installed as shareable images cannot contain external files. (See Chapter 1 and refer to the *OpenVMS Linker Utility Manual* for more information about shareable images.)

On Tru64 UNIX systems, HP COBOL exhibits behavior more like HP COBOL for OpenVMS VAX with regard to shared objects. (Shared objects are the Tru64 UNIX equivalent of OpenVMS shared images.) For more information, see Chapter 12, Interprogram Communication.

#### B.4.11 Sharing Common Blocks (OpenVMS)

On OpenVMS, to prevent problems when you link an HP COBOL program and want to share a common block between processes, you should set the PSECT attribute to SHR. The defaults are SHR on OpenVMS Alpha and OpenVMS I64 systems and NOSHR on OpenVMS VAX systems. Also, you should add a SYMBOL\_VECTOR to the linker options file of the shareable image, as follows:

```
SYMBOL_VECTOR = (psect-name = PSECT)
```

For more information, refer to the *OpenVMS Linker Utility Manual*.

#### B.4.12 Arithmetic Operations

The following arithmetic operations differ in behavior between HP COBOL on Alpha and I64 systems and HP COBOL on VAX:

- Results of numeric and integer intrinsic functions might be formatted differently by a DISPLAY statement.
- OpenVMS VAX handles COMP-2 items in a different way than OpenVMS Alpha and I64 do. As a result, DISPLAY of a USAGE COMP-2 data item's low order digits might be slightly different on Alpha and I64 systems than it would be on VAX.
- HP COBOL on Alpha and I64 issues the ALL\_LOST (all digits lost) warning diagnostic in different cases than HP COBOL on VAX.

For example, if you use POINTER and the size of the data item is not sufficient to hold an address, HP COBOL's more thorough analysis on Alpha and I64 will detect this situation and result in the ALL\_LOST warning diagnostic.

- When overflow occurs in an arithmetic statement without a SIZE ERROR phrase and native arithmetic is used, the results are undefined. HP COBOL on VAX often returns the low order digits of the true result in such cases; HP COBOL on Alpha and I64 does not. When standard arithmetic is used, the results are unaltered.
- The precision of intermediate results is different between HP COBOL on VAX and HP COBOL on Alpha and I64. This is most noticeable in COMPUTE operations involving a divide. If you need a specific precision for an intermediate result, you should use a temporary variable with the desired precision. For example:



## HP COBOL on Four Platforms: Compatibility and Migration

### B.4 HP COBOL Behavior Differences on VAX and Alpha and I64

```
COMPUTE D = ( A / B ) / C.
```

... could be written as

```
COMPUTE TMP1 = A / B.  
COMPUTE D = TMP1 / C.
```

The precision to be used for the calculation  $A / B$  is established by your declaration of TMP1.

- On Tru64 UNIX, the VAX floating point data types F\_FLOAT, D\_FLOAT, and G\_FLOAT are not supported. On OpenVMS Alpha and I64 systems, F\_FLOAT and D\_FLOAT are the defaults for floating point. This difference potentially affects reading data files with COMP-1 and COMP-2 keys built on OpenVMS Alpha and I64 systems. Also, any programs that check for specific floating values rather than *ranges* of values might be impacted.
- The results of numeric comparisons with HP COBOL on VAX and HP COBOL on Alpha and I64 are undefined with invalid decimal data. HP COBOL on Alpha and I64 includes the /CHECK=DECIMAL and -check decimal features to do a more complete analysis of invalid decimal data. These options can be particularly helpful when you are migrating programs to HP COBOL on Alpha and I64.
- The results of numeric operations which produce undefined results (for example, when the size error condition is raised, but the ON SIZE ERROR clause is not used) are likely to be different across VAX, Alpha, and I64.
- There is some inevitable incompatibility in results of arithmetic operations involving large intermediate values between HP COBOL on Alpha and I64 and HP COBOL on VAX. On Alpha and I64, to minimize the differences, you can use the /MATH\_INTERMEDIATE=CIT3 qualifier (or -math\_intermediate cit3). With it, use the /ARITHMETIC=NATIVE qualifier (or -arithmetic native), which is the default. (Specifying /ARITHMETIC=STANDARD would force /MATH\_INTERMEDIATE=CIT4.)

CIT3 gives improved compatibility between HP COBOL on Alpha and I64 HP COBOL on VAX. Even with CIT3, however, there are differences:

- Invalid decimal data

In HP COBOL on Alpha and I64, invalid decimal data detection takes place before any possible conversion to CIT3. CIT3 operations on data items containing invalid decimal data will get results possibly different from those with HP COBOL on VAX.

- Floating-point data items

On Alpha and I64, COBOL expressions involving COMP-1 or COMP-2 data items are converted to G\_floating or T\_floating (depending on the setting for /FLOAT) before conversion to CIT3. CIT3 operations involving D\_floating (on OpenVMS Alpha and I64) data items, in particular, will get different results from VAX.

- Undefined results

If an abnormal condition arises during a CIT3 operation, for example, INTXPOVE (intermediate exponent overflow), and the program continues, and it is not an arithmetic statement with an ON SIZE ERROR clause, then the values that are stored in destination items will be undefined. HP COBOL on Alpha and I64 and HP COBOL on VAX are highly likely to get different undefined results in such cases.

## HP COBOL on Four Platforms: Compatibility and Migration

### B.4 HP COBOL Behavior Differences on VAX and Alpha and I64

- STANDARD dependency  
On VAX, the /STANDARD qualifier has an effect on when arithmetic expression analysis switches to one of the CIT forms. When you specify /STANDARD=V3 (-std v3), CIT is used when more than 18 digit intermediate results are needed. With /STANDARD=85 (-std 85), CIT is used when more than 31 digit intermediate results are needed. The HP COBOL implementations on Alpha and I64 are compatible with HP COBOL on VAX with /STANDARD=85.
- Special contexts  
The CIT3 implementation does not provide support equivalent to the HP COBOL on VAX behavior for intrinsic functions MEDIAN, NUMVAL, and NUMVAL-C.  
See Section 2.7.1 in this manual, and refer to the *HP COBOL Reference Manual* for more information on the /MATH\_INTERMEDIATE and /ARITHMETIC qualifiers.

## B.5 Differences Between Releases and Across Operating Systems

Certain HP COBOL features have unique behaviors, depending on which operating system you are using, and sometimes these differences differ from release to release. You should refer to the Release Notes to get the most recent information about these differences. The next few sections describe distinct differences in feature implementation and behavior.

### B.5.1 REWRITE

A REWRITE operation for an ISAM file is dependent on whether the DUPLICATES clause for the primary key is specified. There is an ambiguity when DUPLICATES is specified in one way at the time a file is created, and another way when it is reopened (a program should use the same declarations). HP COBOL for OpenVMS VAX, HP COBOL for OpenVMS Alpha, and HP COBOL for OpenVMS I64 use the specification of the current program. So, if DUPLICATES was specified for the primary key when a file was created, but not when reopened by the current program, the behavior will be as if DUPLICATES were not allowed.

HP COBOL for Tru64 UNIX issues a severe run-time error if there is a mismatch, unless relax key checking (the -rkc flag) is specified, in which case the behavior is inconsistent. In many cases, you will get the behavior of the specification when the file was created, but you should not rely on this.

### B.5.2 File Sharing and Record Locking

With HP COBOL for Tru64 UNIX, certain file-sharing and record-locking operations might behave differently from the same operations on HP COBOL on OpenVMS Alpha and OpenVMS I64. HP COBOL for Tru64 UNIX issues warning diagnostics where applicable.

- File sharing for sequential and relative files on all systems remains essentially the same.
- File sharing for indexed files has the following limitation: The OPEN statement ALLOWING READERS phrase is minimally supported for indexed files on Tru64 UNIX systems. Using the ALLOWING READERS phrase for indexed files is not recommended.

## HP COBOL on Four Platforms: Compatibility and Migration

### B.5 Differences Between Releases and Across Operating Systems

- File-sharing protocols for all file organizations are in effect for Tru64 UNIX systems for the OPEN statement in OUTPUT mode, which is similar to EXTEND and I-O modes. On Tru64 UNIX systems, access is denied or granted depending on the file lock requested and the file lock held (with the exception of the READERS support noted previously). On OpenVMS Alpha and OpenVMS I64, a new version of the file is always created.
- On Tru64 UNIX, manual record locking for files with the indexed organization has the following limitations:
  - For the READ and START statements, the REGARDLESS phrase is not fully supported. The read or start operation is performed but the soft record lock status is not returned.
  - The START statement does not detect or acquire a record lock.
  - The READ statement with the ALLOWING READERS phrase is not supported. It is treated as NO OTHERS if the file is opened in I-O mode or it is treated as ALL if the file is opened in INPUT mode.
  - The REWRITE and WRITE statements do not retain record locks.
  - The (current) RECORD phrase is not supported for the UNLOCK statement. The ALL RECORDS phrase is assumed for all UNLOCK statements.

#### B.5.3 VFC File Format

If a VFC file is created on OpenVMS Alpha or on OpenVMS I64 and then read on Tru64 UNIX, the data record will be returned with the 2-byte control string in the data record when it is read.

The workaround is to convert the file to a non-VFC format on OpenVMS Alpha or I64 by specifying /NOVFC. Alternatively, you can skip over the VFC bytes when you read the file on Tru64 UNIX.

The following files are by default created in VFC format on OpenVMS Alpha and I64:

```
LINAGE
REPORT WRITER
SEQUENTIAL EXTERNAL/GLOBAL
Output with WRITE ADVANCING
```

#### B.5.4 File Attribute Checking (Tru64 UNIX)

HP COBOL on Tru64 UNIX provides limited file attribute checking. No file attribute checking is performed for sequential and relative files. For indexed files, HP COBOL verifies that the following file attributes match what is specified in the application:

- Number of keys
- Size and position (within the record structure) of each key
- Whether or not duplicates are allowed for each key

If these attributes do not match, the file will not be opened and a fatal run-time error will occur (or Declaratives will be invoked, if applicable).

## HP COBOL on Four Platforms: Compatibility and Migration

### B.5 Differences Between Releases and Across Operating Systems

However, with the relax key checking option selected, HP COBOL for Tru64 UNIX will allow you to open a file that specifies fewer keys than were specified when the file was originally created. This option will provide correct results only in those cases where the unspecified keys are USAGE DISPLAY (PIC X). Also, `-rkc` allows you to open a file that specifies DUPLICATES for a key in a way differently from the specification given when the file was created.

There is an additional check in creating an indexed file: unless relax key checking is specified, you cannot have two keys that are identical except for whether DUPLICATES are allowed. If this restriction is violated, there will be an explicit run-time error message and those operations that are affected by DUPLICATES might give unexpected results.

#### B.5.5 Indexed Files

HP COBOL for Tru64 UNIX treats indexed files differently from the way they are treated by HP COBOL for OpenVMS Alpha, OpenVMS I64, and HP COBOL for OpenVMS VAX. Specifically, on Tru64 UNIX:

- For an indexed file, the run-time system creates two files on the disk: one file with the `dat` extension, and the other file with the `idx` extension.
- If you try to open an indexed file as a sequential file, the key part of any record other than a character key will be different. The reason is that the keys in a record are translated to a file format on disk.
- When you open an existing indexed file, the RTL checks its key structure and returns a severe error if there is a serious mismatch.

On Tru64 UNIX, this RTL check does not detect some differences that would be detected on an OpenVMS Alpha or I64 system, because all but signed 16- and 32-bit integers are mapped onto character strings. For example, if you write an indexed file using a key described as an unsigned 32-bit integer, the character string you will read is the integer with its bytes reversed.

On an OpenVMS Alpha or I64 system, by contrast, you receive a severe error when you try to open a file with the incompatible key.

#### B.5.6 RMS Special Register References in Your Code

HP COBOL for Tru64 UNIX does not support RMS Special Registers. If you include them, you may receive the following general diagnostic message when you attempt to compile the program:

```
cobol: Severe: . . . Undefined name
```

## B.6 File Compatibility Across Languages and Platforms

Files created by different programming languages may require special processing because of language and character set incompatibilities. The most common incompatibilities are data types and data record formats. You should be aware of the following:

- Print-controlled files that are created on the Tru64 UNIX operating system cannot be used as VFC files on the Alpha or I64 operating systems.
- VFC files cannot be used on the Tru64 UNIX operating system.

## HP COBOL on Four Platforms: Compatibility and Migration

### B.6 File Compatibility Across Languages and Platforms

- On Tru64 UNIX, to read a file with variable-length records, you must describe the file as such in the program (use RECORD IS VARYING). On OpenVMS Alpha and OpenVMS I64, you can read a file with variable-length records by using a file description for fixed-length records.
- On OpenVMS Alpha and OpenVMS I64, a file with fixed-length records can be described in a COBOL program with an FD specifying a length shorter than the file record length. On input, the extra data in each record is ignored on OpenVMS Alpha and I64. On Tru64 UNIX, the length specified for the FD must match the actual length of the records in the file; you must *not* use RECORD IS VARYING to read a file with fixed-length records.
- On Alpha and I64, to read a file sequentially, use ORGANIZATION INDEXED, ACCESS SEQUENTIAL (or DYNAMIC), and READ NEXT.

#### Data Type Differences

Data types vary by programming language and by utilities. For example, HP Fortran does not support the PACKED-DECIMAL data type and, therefore, cannot easily use PACKED-DECIMAL data in COBOL files.

You can use the following techniques to overcome data type incompatibilities:

- Use the NATIVE character set, which uses ASCII representation, for all data in files intended for use across languages.
- If your requirements include processing non-ASCII data, you can specify a character set in the SPECIAL-NAMES paragraph of the Environment Division, along with the CODE-SET clause in the SELECT statement. Except for NATIVE, you must specify all character sets in the SPECIAL-NAMES paragraph.
- Use common numeric data types (numeric data types that remain constant across the application).

In the following example, the input file is written in EBCDIC. This creates a file that would be difficult to handle in most languages other than COBOL on OpenVMS Alpha and I64.

```
ENVIRONMENT DIVISION.  
CONFIGURATION SECTION.  
SPECIAL-NAMES.  ALPHABET FOREIGN-CODE IS EBCDIC.  
INPUT-OUTPUT SECTION.  
FILE-CONTROL.  
    SELECT INPUT-FILE ASSIGN TO "INPFIL"  
        CODE-SET IS FOREIGN-CODE.  
    .  
    .  
    .
```

### B.7 LIB\$INITIALIZE Interaction Between C and COBOL

If you use LIB\$INITIALIZE when the main program is written in HP COBOL on Alpha or I64, or on an OpenVMS VAX version prior to Version 7.1, and the initialize routine is written in HP C, the initialize routine will not be called. If you are using OpenVMS VAX Version 7.1 or higher, however, the routine will be called; also, it will be called if your main program is in C or in BASIC rather than COBOL, so this can be a practical workaround.

## HP COBOL on Four Platforms: Compatibility and Migration

### B.7 LIB\$INITIALIZE Interaction Between C and COBOL

The problem is due to the quadword alignment with which C creates the LIB\$INITIALIZE psect. The LIB\$INITIALIZE psect requires longword alignment. The programmer can explicitly specify longword alignment on the `extern_model pragma` to avoid the problem.

### B.8 Reserved Words

Depending on the use of the `/RESERVED_WORDS` qualifier or equivalent flag, there are a number of additional reserved words in HP COBOL on Alpha and I64 that are not reserved in HP COBOL on VAX. Refer to the appendix on reserved words in the *HP COBOL Reference Manual* for complete information.

### B.9 Debugger Support Differences

HP COBOL debugger support on Alpha and I64 differs in several ways from VAX, as follows:

- HP COBOL on Alpha and I64 issues the following informational message when the `/DEBUG` qualifier is used on the COBOL command line with the default optimization in effect:

```
%COBOL-I-DEBUGOPT, /NOOPTIMIZE is recommended with /DEBUG
```

You receive this message if you specify nothing about optimization when you specify `/DEBUG`. (`/OPTIMIZE` is the default for the compiler.) Unlike other informational messages, which are turned off by default, this message is always allowed through by the HP COBOL on Alpha and I64 compiler, even if `/WARN=NOINFO` is in effect. To turn the message off, use any form of the qualifier `/[NO]OPTIMIZE` on the COBOL command line (for example, `/NOOPTIMIZE` or `/OPTIMIZE` or `/OPTIMIZE=LEVEL=x`).

- HP COBOL for OpenVMS VAX does not have the `/OPTIMIZE` qualifier.
- With HP COBOL on Alpha and I64, unlike HP COBOL for OpenVMS VAX, the debugger sometimes changes underscores to hyphens and hyphens to underscores in variable names. This difference from HP COBOL for OpenVMS VAX can help you debug a program.

### B.10 DECset/LSE Support Differences

HP COBOL on Alpha and I64 does not support the DECset/LSE Program Design Facility, the `/DESIGN` qualifier, design comments, or pseudocode placeholders.

### B.11 DBMS Support

On OpenVMS, HP COBOL support for Oracle CODASYL DBMS has some differences depending on whether you are developing programs with HP COBOL on OpenVMS Alpha and I64 or with HP COBOL for OpenVMS VAX.

#### B.11.1 Compiling on Tru64 UNIX

In HP COBOL for Tru64 UNIX, Oracle CODASYL DBMS sub-schema access (DML for Oracle CODASYL DBMS) is not supported. Attempting to compile a program containing any Oracle CODASYL DBMS syntax results in the following diagnostic message:

```
cobol: Severe: . . . DBMS Data Manipulation Language is not supported
```

## HP COBOL on Four Platforms: Compatibility and Migration

### B.11 DBMS Support

Oracle CODASYL DBMS syntax includes the following language elements: COMMIT, CONNECT, DB, DB-EXCEPTION, EMPTY, ERASE, FETCH, FIND, FREE, GET, KEEP, LD, MEMBER, MODIFY, OWNER, READY, RECONNECT, RETAINING, ROLLBACK, STORE, SUB-SCHEMA, TENANT, and WHERE.

You might also receive the following general diagnostic message when you attempt to compile a program (on Tru64 UNIX) that contains variables defined in your Oracle CODASYL DBMS sub-schema:

```
cobol: Severe: . . . Undefined name
```

#### B.11.2 Multistream DBMS DML

With HP COBOL for OpenVMS Alpha and OpenVMS I64, when you use multistream Oracle CODASYL DBMS DML, you must access different schemas or streams from separate source files.

◆





---

## Programming Productivity Tools

Various programming productivity tools can help you increase your productivity as an HP COBOL programmer. These include the following:

- Debugging tools for HP COBOL programs
  - Ladebug Debugger for the Tru64 UNIX operating system (Section C.2)
  - OpenVMS Debugger for the OpenVMS operating system. (Section C.3)
- Language-Sensitive Editor (LSE) and Source Code Analyzer (SCA) (Section C.4), available on the OpenVMS operating system.
- Oracle CDD/Repository (Section C.5), available on the OpenVMS operating system. ♦

### C.1 Debugging Tools for HP COBOL Programs

This appendix includes representative debugging sessions that demonstrate debugger features for both the OpenVMS Debugger and the Tru64 UNIX Ladebug Debugger. These tools are source-level, symbolic debuggers that support HP COBOL data types and use.

Both the OpenVMS Debugger and the Tru64 UNIX Ladebug Debugger let you:

- Control the execution of individual source lines in a program.
- Set stops (breakpoints) at specific source lines or under various conditions.
- Change the value of variables within the debugging environment.
- Refer to program locations by their symbolic names, using the debugger's knowledge of the HP COBOL language to determine the proper scoping rules and how the values should be evaluated and displayed.
- Print the values of variables and set a trace (tracepoint) to notify you when the value of a variable changes.
- Perform other functions, such as executing shell commands, examining core files, examining the call stack, or displaying registers.

The debugging examples in Section C.2 and Section C.3 focus on a sample program, shown in Example C–1. One common program has been used, to emphasize the portability of HP COBOL.

As you read the debugging sections that follow, refer to the code in Example C–1 to identify source lines.

The program, TESTA, accepts a character string from the terminal and passes it to contained program TESTB. TESTB reverses the character string and returns it (and its length) to TESTA.

# Programming Productivity Tools

## C.1 Debugging Tools for HP COBOL Programs

### Example C-1 Source Code Used in the Sample Debug Sessions

```
module TESTA
  1: IDENTIFICATION DIVISION.
  2: PROGRAM-ID. TESTA.
  3: DATA DIVISION.
  4: WORKING-STORAGE SECTION.
  5:     01 TESTA-DATA          GLOBAL.
  6:         02 LET-CNT        PIC 9(2)V9(2).
  7:         02 IN-WORD        PIC X(20).
  8:         02 DISP-COUNT     PIC 9(2).
  9: PROCEDURE DIVISION.
10: BEGINIT.
11:     DISPLAY "ENTER WORD:".
12:     MOVE SPACES TO IN-WORD.
13:     ACCEPT IN-WORD.
14:     CALL "TESTB" USING IN-WORD LET-CNT.
15:     PERFORM SHOW-IT.
16:     STOP RUN.
17: SHOW-IT.
18:     DISPLAY IN-WORD.
19:     MOVE LET-CNT TO DISP-COUNT.
20:     DISPLAY DISP-COUNT " CHARACTERS".
21: IDENTIFICATION DIVISION.
22: PROGRAM-ID. TESTB  INITIAL.
23: DATA DIVISION.
24: WORKING-STORAGE SECTION.
25:     01 SUB-1 PIC 9(2) COMP.
26:     01 SUB-2 PIC S9(2) COMP-3.
27:     01 HOLD-WORD.
28:         03 HOLD-CHAR PIC X OCCURS 20 TIMES.
29:     01 HOLD-CHARS-REHOLD-WORD.
30:         03 CHARS PIC X(20).
31: LINKAGE SECTION.
32:     01 TEMP-WORD.
33:         03 TEMP-CHAR PIC X OCCURS 20 TIMES.
34:     01 TEMP-CHARS REDEFINES TEMP-WORD.
35:         03 CHARS PIC X(20).
36:     01 CHARCT PIC 99V99.
37: PROCEDURE DIVISION USING TEMP-WORD, CHARCT.
38: STARTUP.
39:     IF TEMP-WORD = SPACES
40:         MOVE 0 TO CHARCT
41:         EXIT PROGRAM.
42:     MOVE SPACES TO HOLD-WORD.
43:     PERFORM LOOK-BACK VARYING SUB-1 FROM 20 BY -1
44:         UNTIL TEMP-CHAR (SUB-1) NOT = SPACE.
45:     MOVE SUB-1 TO CHARCT.
46:     PERFORM MOVE-IT VARYING SUB-2 FROM 1 BY 1 UNTIL SUB-1 = 0.
47:     MOVE HOLD-WORD TO TEMP-WORD.
48: MOVE-IT.
49:     MOVE TEMP-CHAR (SUB-1) TO HOLD-CHAR (SUB-2).
50:     SUBTRACT 1 FROM SUB-1.
51: LOOK-BACK.
52:     EXIT.
53: END PROGRAM TESTB.
54: END PROGRAM TESTA.
```

## C.2 Ladebug Debugger (Tru64 UNIX)

The Ladebug Debugger is used to debug HP COBOL programs on the Tru64 UNIX operating system.

This section provides a representative debugging session that is designed to demonstrate the use of debugger features. For complete reference information on the Ladebug Debugger, you should refer to the *Ladebug Debugger Manual* in the Tru64 UNIX operating system documentation set. Online help is immediately available to you during a debugging session when you type `help command` at the debugger prompt (`ladebug`). Additional information about the flags shown in this section is available in the man page. For example, you can type `man cobol`, and page to the appropriate topic to read information about the flags (`-g`, `-o`) used at the beginning of the example in this section.

1. To begin this example you compile an HP COBOL program consisting of the single compilation unit named TESTA.

```
% cobol -g -o testa testa.cob
cobol: Warning: file not optimized; use -g3 for debug with optimize
%
```

The `-g` switch on the compiler command causes the compiler to write the debugger symbol table associated with the program into the executable program.

Normally, the compiler turns off optimization when you specify `-g` and gives a warning to that effect. To debug your program with full optimization turned on, use the `-g3` switch.

2. The `ladebug` command starts the session. You provide your program name as a parameter (argument) to the command. After the debugger reads in your program's symbol table, it returns control with its prompt, (`ladebug`).

```
% ladebug testa
Welcome to the Ladebug Debugger Version 2.0.8 eft
-----
object file name: testa
Reading symbolic information ...done
(ladebug)
```

3. Set a breakpoint. In this case, you wish to break at line 43 of your program.

```
(ladebug) stop at 43
[#2: stop at "testa.cob":43 ]
```

4. Begin execution with the `run` command. The debugger starts program TESTA, prompts for a keyboard entry, and waits for a response.

```
(ladebug) run
ENTER WORD
```

5. Enter the word to be reversed. Execution continues until the image reaches the breakpoint at line 43 of the contained program.

```
abc
[2] stopped at [TESTB:43 0x120001aa4]
   43      PERFORM LOOK-BACK  VARYING SUB-1 FROM 20 BY -1
```

## Programming Productivity Tools

### C.2 Ladebug Debugger (Tru64 UNIX)

6. Set two breakpoints. You can give the debugger a list of commands to execute at breakpoints; the commands are entered in braces ({}).

```
(ladebug) stop at 47
[#2: stop at "testa.cob":47 ]
(ladebug) when at 50 { print chars of hold-chars; print SUB-1; cont; }
[#3: when at "testa.cob":50 { print CHARS of HOLD-CHARS; print SUB-1; ; cont ; ; } ]
```

7. Display the active breakpoints.

```
(ladebug) status
#1 PC==0x120001e14 in testa "testa.cob":2 { break }
#2 PC==0x120001ba4 in TESTB "testa.cob":47 { break }
#3 PC==0x120001c1c in TESTB "testa.cob":50
  { ; print CHARS of HOLD-CHARS; print SUB-1; ; cont ; ; }
```

8. Use the list command to display the source lines where you set breakpoints.

```
(ladebug) list 43,50
43     PERFORM LOOK-BACK  VARYING SUB-1 FROM 20 BY -1
44         UNTIL TEMP-CHAR (SUB-1) NOT = SPACE.
45     MOVE SUB-1 TO CHARCT.
46     PERFORM MOVE-IT    VARYING SUB-2 FROM 1 BY 1    UNTIL SUB-1 = 0.
47     MOVE HOLD-WORD TO TEMP-WORD.
48 MOVE-IT.
49     MOVE TEMP-CHAR (SUB-1) TO HOLD-CHAR (SUB-2).
50     SUBTRACT 1 FROM SUB-1.
```

9. Set a tracepoint at line 15 of TESTA.

```
(ladebug) trace at 15
[#3: trace at "testa.cob":15 ]
```

10. Set a watchpoint on the data item DISP-COUNT. When an instruction tries to change the contents of DISP-COUNT, the debugger returns control to you.

```
(ladebug) stop disp-count of testa-data
[#4: stop if DISP-COUNT of TESTA-DATA changes ]
```

11. Execution resumes with the cont command. Each time line 50 in TESTB executes, the debugger executes the command list associated with this line; it displays the contents of HOLD-CHARS and SUB-1, then resumes execution. Finally, the debugger returns control to the user when the breakpoint at line 47 is reached.

```
(ladebug) cont
[3] when [TESTB:50 0x120001c1c]
" c "
3
[3] when [TESTB:50 0x120001c1c]
" cb "
2
[3] when [TESTB:50 0x120001c1c]
" cba "
1
[2] stopped at [TESTB:47 0x120001ba4]
47     MOVE HOLD-WORD TO TEMP-WORD.
```

12. Examine the contents of SUB-1.

```
(ladebug) whatis sub-1
unsigned short SUB-1
(ladebug) print sub-1
0
```

## Programming Productivity Tools C.2 Ladebug Debugger (Tru64 UNIX)

13. Deposit the value -42 into data item SUB-2.

```
(ladebug) whatis sub-2
pic s99 usage comp-3 SUB-2
(ladebug) assign sub-2=-42
```

14. Examine the contents of SUB-2.

```
(ladebug) print sub-2
-42
```

15. Examine the contents of CHARCT, whose picture is 99V99.

```
(ladebug) whatis charct
pic 99v99 usage display charct
(ladebug) print charct
3.00
```

16. Deposit a new value into CHARCT.

```
(ladebug) assign charct=15.95
```

17. CHARCT now contains the new value.

```
(ladebug) print charct
15.95
```

18. You can examine any character of a subscripted data item by specifying the character position. The following EXAMINE command accesses the second character in TEMP-CHAR.

```
(ladebug) print temp-char of temp-word(2)
"b"
```

19. You can qualify data names in debug commands as you can in HP COBOL. For example, if you examine IN-WORD while you debug your program, you can use the following Ladebug Debugger command:

```
(ladebug) print in-word of testa-data
"abc"
```

20. Restore CHARCT to its original value.

```
(ladebug) assign charct=3.00
```

21. Resume execution with the cont command. The program TESTA displays the reversed word. When the image reaches line 19 in TESTA, the debugger detects that an instruction changed the contents of DISP-COUNT. Because you set a watchpoint on DISP-COUNT, the debugger displays the old and new values, then returns control to you.

```
(ladebug) cont
[3] [calling testa from main cob_main.c:253 0x3ff8181f054]
cba
[4] The value of DISP-COUNT of TESTA-DATA was changed in testa,
before entering cob_acc_display
Old value = 0
New value = 3
[4] stopped at [cob_acc_display:349 0x3ff81808744]
(Cannot find source file cob_accdis.c)
```

Note that the Ladebug Debugger “watch” command shown here (stop disp-count of testa-data) does not stop immediately at the point when the value of the watched variable changes. In this example, the debugger takes control at the first procedure call or return after the value of the watched variable

## Programming Productivity Tools

### C.2 Ladebug Debugger (Tru64 UNIX)

changes. For more information on the behavior of Ladebug Debugger watch, refer to the *Ladebug Debugger Manual*.

22. To see the executable's current location, use the where command. Then, set the debugger file scope back to the main COBOL program, and stop at a specified line number in that file.

```
(ladebug) where
>0 0x3ff81808744 in cob_acc_display() cob_accdis.c:349
#1 0x120001fbc in testa() testa.cob:20
#2 0x3ff8181f054 in main() cob_main.c:253
(ladebug) file testa.cob
(ladebug) stop at 20
[#6: stop at "testa.cob":20 ]
```

23. Resume execution with the cont command. TESTA executes its final display. The debugger regains control when STOP RUN executes.

```
(ladebug) cont
03 CHARACTERS
Thread has finished executing
```

24. At this point you end the session with the q command.

```
(ladebug) q
```



### C.3 OpenVMS Debugger (OpenVMS)

This section provides an introduction to using the OpenVMS debugger with HP COBOL programs. It includes the following:

- A description of OpenVMS debugger support for HP COBOL
- A note about using both the /DEBUG qualifier and the /NOOPTIMIZE (Alpha and I64 only) qualifier when you compile images for debugging
- A sample debugging session that demonstrates using the debugger

For complete reference information on the OpenVMS debugger, refer to the *OpenVMS Debugger Manual* in the OpenVMS documentation set. Online help is immediately available to you during a debugging session when you type the HELP command at the debugger prompt (DBG>).

#### C.3.1 Notes on HP COBOL Support

In general, the OpenVMS debugger supports the data types and operators of HP COBOL and other debugger-supported languages. However, there are important language-specific limitations. (To get information about the supported data types and operators for a language, type the HELP LANGUAGE command at the DBG> prompt.)

The debugger shows source text included in a program with the COBOL COPY *file* statement or the COPY *module of library* statement. However, the debugger does not show text which was created with the COPY REPLACING or REPLACE statement, or included by the COPY *text* FROM DICTIONARY statement.

The debugger cannot show the original source lines associated with the code for a REPORT section. You can see the DATA SECTION source lines associated with a report, but no source lines are associated with the compiled code that generates the report.

### **C.3.2 Notes on Debugging Optimized Programs (Alpha, I64)**

The HP COBOL compiler is a highly optimizing compiler. Several of the optimizations it performs, such as instruction scheduling and label deletion, can cause unexpected behavior in the OpenVMS Debugger.

Instruction scheduling can make the debugger appear to execute statements out of order. A single COBOL source statement can often result in several machine instructions. A RISC architecture machine, like the Alpha processor, can start working on a new instruction every machine cycle, but not all instructions can complete within one machine cycle. If the output from one machine instruction is used as the input to a subsequent machine instruction, the machine cannot begin processing the second instruction until it has finished processing the first. In many cases an entirely separate instruction can execute in parallel with the first instruction to perform a related computation.

During instruction scheduling, instructions are reordered to minimize waiting time. As a result an instruction resulting from a subsequent COBOL statement can be scheduled in the middle of (or even before) a sequence of instructions from a preceding statement. This reordering NEVER changes the meaning of your program, but it can make your program's execution in the debugger seem incorrect. The most common symptom of instruction scheduling is that the pointer in the debugger source window jumps back and forth between lines when you use the debugger STEP command.

When the compiler performs label deletion, it deletes paragraph and section labels that you do not explicitly reference in your source program. This prevents you from setting breakpoints on the affected labels which can make the analysis and optimization of your program more difficult.

Because of these and other HP COBOL compiler optimizations, Hewlett-Packard recommends that you use the /NOOPTIMIZE qualifier in conjunction with the /DEBUG qualifier when you are debugging your COBOL programs. Using /NOOPTIMIZE qualifier disables most of the HP COBOL optimizations. In particular it suppresses most instruction scheduling and all label deletion optimizations.

### **C.3.3 Sample Debugging Session (Alpha, I64)**

The following OpenVMS Alpha and I64 debugging session does not show the location of program errors; it is designed to show only the use of debugger features.

1. The following example shows how to compile and link an HP COBOL program consisting of a single compilation unit named TESTA.

```
$ COBOL/DEBUG/NOOPTIMIZE TESTA  
$ LINK/DEBUG TESTA
```

The /DEBUG qualifier on the COBOL command causes the compiler to write the debug symbol records associated with TESTA into the object module, TESTA.OBJ. These records allow you to use the names of variables and other symbols declared in TESTA in debugger commands. (If your program has several compilation units, you must compile each unit that you want to debug with the /DEBUG qualifier.)

## Programming Productivity Tools

### C.3 OpenVMS Debugger (OpenVMS)

For Alpha and I64, the /NOOPTIMIZE qualifier on the COBOL command disables default optimization for debugging. Because HP COBOL is, by default, a highly optimizing compiler, you will notice unusual and confusing program execution when you step through an optimized program with the debugger.

The /DEBUG qualifier on the LINK command causes the linker to include all symbol information that is contained in TESTA.OBJ in the executable image. The qualifier also causes the image activator to start the debugger at run time. (If your program has several object modules, you might need to specify other modules in the LINK command.)

2. The RUN command starts the session. If you compile and link the program with /DEBUG, you do not need to use the /DEBUG qualifier in the RUN command.

When you give the RUN command, the debugger displays its standard header, showing that the default language is COBOL and the default scope and module are your main program. The debugger returns control with the prompt, DBG>.

```
$ RUN TESTA
OpenVMS Alpha DEBUG Version V7.1-000

%DEBUG-I-INITIAL, Language: COBOL, Module: TESTA
%DEBUG-I-NOTATMAIN, type GO to get reach MAIN program
DBG>
```

3. Use the GO command to get to the start of the main program.

```
DBG> GO
break at routine TESTA
    11:    DISPLAY "ENTER WORD"
```

4. Set a breakpoint.

```
DBG> SET BREAK %LINE 43
```

5. Begin execution with the GO command. The debugger displays the execution starting point, and the image continues until TESTA displays its prompt and waits for a response.

```
DBG> GO
ENTER WORD:
```

6. Enter the word to be reversed. Execution continues until the image reaches the breakpoint at line 43 of the contained program.

```
abc
break at TESTA\TESTB\%LINE 43
    43:    PERFORM LOOK-BACK VARYING SUB-1 FROM 20 BY -1
```

7. Set two breakpoints. When the debugger reaches line 50 of TESTB, it executes the commands in parentheses, displays the two data items, and resumes execution.

```
DBG> SET BREAK %LINE 47
DBG> SET BREAK %LINE 50 DO (EXAMINE HOLD-CHARS;EXAMINE SUB-1;GO)
```



## Programming Productivity Tools C.3 OpenVMS Debugger (OpenVMS)

8. Display the active breakpoints.

```
DBG> SHOW BREAK
breakpoint at TESTA\TESTB\%LINE 43
breakpoint at TESTA\TESTB\%LINE 47
breakpoint at TESTA\TESTB\%LINE 50
do (EXAMINE HOLD-CHARS;EXAMINE SUB-1;GO)
```

9. Use the TYPE command to display the source lines where you set breakpoints.

```
DBG> TYPE 43:50
module TESTA
43:    PERFORM LOOK-BACK  VARYING SUB-1 FROM 20 BY -1
44:        UNTIL TEMP CHAR (SUB-1) NOT = SPACE.
45:    MOVE SUB-1 TO CHARCT.
46:    PERFORM MOVE-IT  VARYING SUB-2 FROM 1 BY 1  UNTIL SUB-1 = 0.
47:    MOVE HOLD-WORD TO TEMP-WORD.
48: MOVE-IT.
49:    MOVE TEMP-CHAR (SUB-1)  TO HOLD-CHAR (SUB-2).
50:    SUBTRACT 1 FROM SUB-1.
```

10. Set a tracepoint at line 15 of TESTA.

```
DBG> SET TRACE %LINE 15
```

11. Set a watchpoint on the data item DISP-COUNT. When an instruction tries to change the contents of DISP-COUNT, the debugger returns control to you.

```
DBG> SET WATCH DISP-COUNT
DEBUG-I-WPTRACE, non-static watchpoint, tracing every instruction
```

12. Execution resumes with the GO command. Before line 50 in TESTB executes, the debugger executes the contents of the DO command entered at step 7. It displays the contents of HOLD-CHARS and SUB-1, then resumes execution.

```
DBG> GO
break at TESTA\TESTB\%LINE 50
50:    SUBTRACT 1 FROM SUB-1.
TESTA\TESTB\HOLD-CHARS:
CHARS:      "c          "
TESTA\TESTB\SUB-1:      3
break at TESTA\TESTB\%LINE 50
50:    SUBTRACT 1 FROM SUB-1.
TESTA\TESTB\HOLD-CHARS
CHARS:      "cb        "
TESTA\TESTB\SUB-1:      2
break at TESTA\TESTB\%LINE 50
50:    SUBTRACT 1 FROM SUB-1.
TESTA\TESTB\HOLD-CHARS
CHARS:      "cba       "
TESTA\TESTB\SUB-1:      1
break at TESTA\TESTB\%LINE 47
47:    MOVE HOLD-WORD TO TEMP-WORD.
DBG>
```

13. Examine the contents of SUB-1.

```
DBG> EXAMINE SUB-1
TESTA\TESTB\SUB-1:      0
```

14. Deposit the value -42 into data item SUB-2.

```
DBG> DEPOSIT SUB-2 = -42
```

## Programming Productivity Tools

### C.3 OpenVMS Debugger (OpenVMS)

15. Examine the contents of SUB-2.

```
DBG> EXAMINE SUB-2
TESTA\TESTB\SUB-2:  -42
```

16. Examine the contents of CHARCT, whose picture is 99V99.

```
DBG> EXAMINE CHARCT
TESTA\TESTB\CHARCT:  3.00
```

17. Deposit four characters into CHARCT.

```
DBG> DEPOSIT CHARCT=15.95
```

18. CHARCT now contains 15.95.

```
DBG> EXAMINE CHARCT
TESTA\TESTB\CHARCT:  15.95
```

19. Deposit an integer larger than CHARCT's definition. The debugger returns an error message.

```
DBG> DEPOSIT CHARCT=2890
%DEBUG-E-DECOVF, decimal overflow at or near DEPOSIT
```

20. Examine the contents of CHARCT.

```
DBG> EXAMINE CHARCT
TESTA\TESTB\CHARCT:  15.95
```

21. You can examine any character of a subscripted data item by specifying the character position. The following EXAMINE command accesses the second character on TEMP-CHAR.

```
DBG> EXAMINE TEMP-CHAR(2)
TEMP-CHAR of TESTA\TESTB\TEMP-WORD(2):  "b"
```

22. You can use the DEPOSIT command to put a value into any element of a table and examine its contents. In this example, "x" is deposited into the second character position of TEMP-CHAR.

```
DBG> DEPOSIT TEMP-CHAR(2)="x"
DBG> EXAMINE TEMP-CHAR(2)
TEMP-CHAR of TESTA\TESTB\TEMP-WORD(2):  "x"
```

23. You can qualify data names in debug commands as you can in COBOL. For example, if you examine IN-WORD while you debug your program, you can use the following DEBUG command:

```
DBG> EXAMINE IN-WORD of TESTA-DATA
IN-WORD OF TESTA\TESTA-DATA:  "axc"
```

24. Deposit a value into CHARCT.

```
DBG> DEPOSIT CHARCT=8.00
```

25. Resume execution with the GO command. The program TESTA displays the reversed word. When the image reaches line 19 in TESTA, the debugger detects that an instruction changed the contents of DISP-COUNT. Because you set a watchpoint on DISP-COUNT, the debugger displays the old and new values, then returns control to you.

## Programming Productivity Tools C.3 OpenVMS Debugger (OpenVMS)

```
DBG> GO
cba
trace at TESTA\%LINE 15
  15:   PERFORM SHOW-IT.
watch of DISP-COUNT of TESTA\TESTA-DATA at TESTA\%LINE 19+52
  19:   MOVE LET-CNT TO DISP-COUNT.
        old value = 0
        new value = 3
break at TEST-A\%LINE 20
  20:  DISPLAY DISP-COUNT " CHARACTERS".
```

26. To see the image's current location, use the SHOW CALLS command.

```
DBG> SHOW CALLS
module name      routine name          line    rel PC    abs PC
*TESTA          TESTA                          22     00000120 00030120
                                     00000080 000306C0
                                     LIB$INITIALIZE                   85739D00 8576A530
                                     00000080 7FE61F30
```

27. Resume execution with the GO command. TESTA executes its final display. The debugger regains control when STOP RUN executes.

```
DBG> GO
03 CHARACTERS
%DEBUG-I-EXITSTATUS, is '%SYSTEM-S-NORMAL, normal successful completion'
```

28. At this point, you can either examine the contents of data items or end the session with the EXIT command.

```
DBG> EXIT
$
```

### C.3.3.1 Separately Compiled Programs

When you debug an HP COBOL program, the default module (which will be brought into the debugger) is the main module name. If your program consists of multiple separately compiled programs (SCPs), and was compiled with the /SEPARATE\_COMPILATION qualifier (see Section 1.2.2.4 and Section B.4.2.8), each module that you wish to debug other than the main module must be identified to the debugger.

For example:

```
DBG> SET BREAK %LINE 43
```

In the previous example, the default module is the main module name. You can specify a different module in those cases where you use multiple separately compiled programs as follows:

```
DBG> SET BREAK modulename \ %LINE 43
```

In the preceding example, the default debug module becomes *modulename*. The same result can be obtained by using SET MODULE, as follows:

```
DBG> SET MODULE modulename
DBG> SET BREAK %LINE 43
```

If *modulename* is a valid module, the default will be set to that module name and the debugger prompt will be returned. You can then set a breakpoint (or any other valid debugger action) in the new module source. If it is not a valid module, the system will advise you as follows:

```
DBG> SET MODULE invalidmodulename
%DEBUG-E-NOSUCHMODU, module INVALIDMODULENAME is not in module chain
```

## Programming Productivity Tools

### C.4 Language-Sensitive Editor and the Source Code Analyzer (OpenVMS)

#### C.4 Language-Sensitive Editor and the Source Code Analyzer (OpenVMS)

The Language-Sensitive Editor (LSE) is a powerful and flexible text editor designed specifically for software development. The Source Code Analyzer (SCA) is an interactive tool for program analysis.

These products are closely integrated; generally, you can invoke SCA through LSE. LSE provides additional editing features that make SCA program analysis more efficient. In conjunction with the HP COBOL compiler, the two tools provide a set of new enhancements supporting source code design and review.

LSE also provides the following software development features:

- Formatted language constructs, or templates, for the programming languages it supports, including HP COBOL. These templates include the keywords and punctuation used in source programs.
- Commands to compile, review, and correct compilation errors from within the editor. The HP COBOL compiler for Alpha and I64 issues some diagnostics in a different sequence from HP COBOL for OpenVMS VAX. The LSE review of compilation errors reflects the sequence in which the particular compiler issues the diagnostics.
- Integration with Code Management System (CMS). You can issue CMS commands from within the editor to make source file management more efficient. Refer to the *Guide to Code Management System for VMS Systems* for more information.

SCA performs the following types of program analysis:

- Cross-referencing, which supplies information about program symbols and source files
- Static analysis, which provides information on how subprograms, symbols, and files are related

LSE and SCA together, in conjunction with compilers for supported languages, provide the following software design features:

- View support, which provides a reverse-design facility. LSE commands compress program code into overview line summaries. If you choose to edit these overview lines, the program code reflects the modifications you make.
- A report tool, callable through LSE, which can print views, standard design reports, and customized reports.

##### C.4.1 Notes on HP COBOL Support

HP COBOL supports the LSE and SCA program creation, analysis, and compilation features described in the preceding sections. HP COBOL on OpenVMS Alpha and OpenVMS I64 does not support the LSE Program Design Facility (PDF) design comments, pseudocode placeholders, or the /DESIGN qualifier.

The following sections provide entry, exit, and language-specific information on the combined use of LSE and SCA.

## C.4 Language-Sensitive Editor and the Source Code Analyzer (OpenVMS)

### For More Information:

- On LSE—Refer to the *Guide to Language-Sensitive Editor*.
- On SCA—Refer to the *Guide to Source Code Analyzer for VMS Systems*.
- On CMS—Refer to the *Guide to Code Management System for VMS Systems*.

### C.4.2 Preparing an SCA Library

SCA stores data generated by the HP COBOL compiler in an SCA library. The data in an SCA library contains information about all symbols, modules, and files encountered during a specific compilation of the source. You must prepare this library before you enter LSE to invoke SCA by following these steps:

1. Create a directory for your SCA library. For example:

```
$ CREATE/DIRECTORY PROJ:[USER.LIB1]
```

2. Initialize and set the library with the SCA CREATE LIBRARY command. For example:

```
$ SCA CREATE LIBRARY [.LIB1]
```

If you have an existing SCA library that has been initialized, you make its contents visible to SCA by setting it with the SCA SET LIBRARY command. For example:

```
$ SCA SET LIBRARY [.EXISTING_SCA_LIBARAY]
```

A message appears in the message buffer at the bottom of your screen, indicating whether or not your SCA library selection succeeded.

3. Direct the COBOL compiler to generate data analysis files by appending the /ANALYSIS\_DATA qualifier to the COBOL command. For example:

```
$ COBOL/ANALYSIS_DATA PG1,PG2,PG3
```

This command line compiles the input files PG1.COB, PG2.COB and PG3.COB, and generates corresponding output files for each input file, with the file types OBJ and ANA. The COBOL compiler puts these files in your current default directory.

4. Load the information in the data analysis files into your SCA library with the LOAD command. For example:

```
$ SCA LOAD PG1,PG2,PG3
```

This command loads your library with the modules contained in the data analysis files PG1.ANA, PG2.ANA, and PG3.ANA.

5. Once you have prepared the SCA library, you enter LSE to begin an SCA session. Within this context, the integration of LSE and SCA provides commands that you can use only within LSE.

### C.4.3 Starting and Terminating an LSE or an SCA Session

To invoke LSE, issue the following command at the DCL prompt:

```
$ LSEDIT USER.COB
```

To end an LSE session, press CTRL/Z to get the LSE> prompt. If you wish to save modifications to your file, issue the EXIT command. If you do not wish to save the file or any modification to the file, issue the QUIT command.

## Programming Productivity Tools

### C.4 Language-Sensitive Editor and the Source Code Analyzer (OpenVMS)

To invoke SCA from LSE, type the SCA command that you wish to execute at the LSE> prompt, as in the following syntax:

```
LSE> command [parameter] [/qualifier...]
```

To invoke SCA from the DCL command line for the execution of a single command, you can use the following syntax:

```
$ SCA command [parameter] [/qualifier...]
```

If you have several SCA commands to invoke, you might wish to use the SCA subsystem to enter commands, as in the following syntax:

```
$ SCA  
SCA> command [parameter] [/qualifier...]
```

Typing EXIT (or pressing CTRL/Z) ends an SCA subsystem session and returns you to the DCL level.

#### C.4.4 Compiling from Within LSE

To compile a completed COBOL program, issue the following command at the LSE prompt:

```
LSE> COMPILE
```

To compile a COBOL program that contains placeholders and design comments, include the following qualifiers with the previous command:

```
LSE> COMPILE $/ANALYSIS_DATA
```

The /ANALYSIS\_DATA qualifier causes the compiler to generate a data analysis file containing source code analysis information and to provide this information to the SCA library.

LSE provides several commands to help you review errors and examine your source code:

Command	Key Binding	Function
COMPILE	None	Compiles the contents of the source buffer. You can issue this command with the /REVIEW qualifier to put LSE in REVIEW mode immediately after the compilation.
REVIEW	None	Puts LSE into REVIEW mode and displays any errors resulting from the last compilation.
END REVIEW	None	Removes the buffer \$REVIEW from the screen; returns the cursor to a single window containing the source buffer.
GOTO SOURCE	CTRL/G	Moves the cursor to the source buffer that contains the error.
NEXT STEP	CTRL/F	Moves the cursor to the next error in the buffer \$REVIEW.
PREVIOUS STEP	CTRL/B	Moves the cursor to the previous error in the buffer \$REVIEW.
	{ Down arrow } { Up arrow }	Moves the cursor within a buffer.

## **C.5 Using Oracle CDD/Repository (OpenVMS)**

Oracle CDD/Repository is an optional software product available under a separate license. The Oracle CDD/Repository product lets you maintain shareable data definitions, such as record and field definitions. Oracle CDD/Repository data definitions are organized hierarchically in much the same way that files are organized in directories and subdirectories. For example, a repository for defining personnel data might have separate directories for each employee type.

Often, it is the job of a repository or data administrator to create repositories, define directory structures, and insert record and field definitions into the repository. In large organizations, many repositories can be linked together to form one logical repository. Once the repositories are established, the data definitions can be used throughout the organization by database administrators and application developers. If the paths are set up correctly, users can access definitions as if they were in a single repository.

Descriptions of data definitions are entered into the repository in a special-purpose language called Common Dictionary Operator (CDO). (Oracle CDD/Repository also supports both the Common Data Dictionary (Version 3) and CDD/Plus (Version 4) interfaces for use by existing databases and applications.) Oracle CDD/Repository converts the data descriptions to an internal form—making them independent of the language used to access them—and inserts them into the repository.

When you compile a COBOL program, Oracle CDD/Repository data definitions can be accessed by means of the COPY FROM DICTIONARY statement. If the attributes of the data definitions are consistent with HP COBOL requirements, the data definitions are included in the COBOL program. Oracle CDD/Repository data definitions, in the form of COBOL source code, can appear in source program listings if you specify the /LIST and /COPY\_LIST qualifiers on the COBOL command line.

Oracle CDD/Repository can also store information about the structure of a program, such as the compiled modules that go into making an object module, or the record and field definitions that are used by COBOL programs. If, for example, a record definition needs to change, you can analyze the impact that change will have on the various programs that use it. When the definition is changed, Oracle CDD/Repository notifies the modules that the record definition is out of date, and the program can be recompiled.

To take advantage of dependency recording, you must:

- Enable dependency recording by compiling your program with the /DEPENDENCY\_DATA qualifier.
- Direct the COBOL compiler to a repository or a compatibility dictionary in which to store the dependency information.

### **C.5.1 Creating Record and Field Definitions**

The following example shows how you can use CDO to create a number of fields representing name and address information:

## Programming Productivity Tools

### C.5 Using Oracle CDD/Repository (OpenVMS)

```
DEFINE FIELD NAME
    DATATYPE IS TEXT
    SIZE IS 25 CHARACTERS.
DEFINE FIELD COMPANY_NAME
    DATATYPE IS TEXT
    SIZE IS 25 CHARACTERS.
DEFINE FIELD STREET
    DATATYPE IS TEXT
    SIZE IS 20 CHARACTERS.
DEFINE FIELD CITY
    DATATYPE IS TEXT
    SIZE IS 20 CHARACTERS.
DEFINE FIELD STATE
    DATATYPE IS TEXT
    SIZE IS 2 CHARACTERS.
DEFINE FIELD ZIP
    DATATYPE IS TEXT
    SIZE IS 5 CHARACTERS.
```

The fields can then be used to create records. The following example creates two records — one for customer address information and one for employee address information:

```
DEFINE RECORD CUSTOMER_ADDRESS_RECORD.
    NAME.
    COMPANY_NAME.
    STREET.
    STATE.
    ZIP.
END RECORD.
DEFINE RECORD EMPLOYEE_ADDRESS_RECORD.
    NAME.
    STREET.
    STATE.
    ZIP.
END RECORD.
```

#### C.5.2 Accessing Oracle CDD/Repository Definitions from HP COBOL Programs

You access repository data definitions from a COBOL program using the COPY FROM DICTIONARY statement. At compile time, the record definition and its attributes are extracted from the designated repository. Then the compiler converts the extracted definition into a COBOL declaration. For example, the following COBOL statements access the customer and employee address records defined earlier. These definitions have been placed in the repository directory DEVICE:[VMS\_DIRECTORY]SALES.

```
IDENTIFICATION DIVISION.
PROGRAM-ID. MASTER-FILE.
DATA DIVISION.
WORKING-STORAGE SECTION.
COPY "DEVICE:[VMS_DIRECTORY]SALES.CUSTOMER_ADDRESS_RECORD" FROM DICTIONARY.
COPY "DEVICE:[VMS_DIRECTORY]SALES.EMPLOYEE_ADDRESS_RECORD" FROM DICTIONARY.
.
.
.
```

If you compile this program with the /LIST and /COPY\_LIST qualifiers, the source listing includes the data definition translated into a COBOL declaration, as shown in the following example:



## Programming Productivity Tools C.5 Using Oracle CDD/Repository (OpenVMS)

```
1 IDENTIFICATION DIVISION.
2 PROGRAM-ID. MASTER-FILE.
3 DATA DIVISION.
4 WORKING-STORAGE SECTION.
5 COPY "DEVICE:[VMS_DIRECTORY]SALES.CUSTOMER_ADDRESS_RECORD" FROM DICTIONARY.
L 6 *
L 7 *DEVICE:[VMS_DIRECTORY].SALES.CUSTOMER_ADDRESS_RECORD
L 8 *
L 9 01 CUSTOMER_ADDRESS_RECORD.
L 10 02 NAME PIC X(25).
L 11 02 COMPANY_NAME PIC X(25).
L 12 02 STREET PIC X(20).
L 13 02 CITY PIC X(20).
L 14 02 STATE PIC X(2).
L 15 02 ZIP PIC X(5).
L 16 COPY "NODE::DEVICE:[VMS_DIRECTORY]SALES.EMPLOYEE_ADDRESS_RECORD" FROM DICTIONARY.
L 17 *
L 18 *DEVICE:[VMS_DIRECTORY].SALES.EMPLOYEE_ADDRESS_RECORD
L 19 *
L 20 01 EMPLOYEE_ADDRESS_RECORD.
L 21 02 NAME PIC X(25).
L 22 02 STREET PIC X(20).
L 23 02 CITY PIC X(20).
L 24 02 STATE PIC X(2).
L 25 02 ZIP PIC X(5).
.
.
.
```

For more information on the COPY FROM DICTIONARY statement, refer to the *HP COBOL Reference Manual*. For more information on the /LIST and /COPY\_LIST command qualifiers, invoke the online help facility for COBOL at the operating system prompt.

### C.5.3 Recording Dependencies

When you compile a program with the /DEPENDENCY\_DATA qualifier, the compiler creates the following repository objects to represent the compiled modules, the resulting object module, and the relationships between them:

- A compiled module object is created for each separately compiled program. The name of the object is the PROGRAM-ID name with hyphens translated to underscores. Compiled module objects are put in the repository pointed to by the logical name CDD\$DEFAULT, or in the compatibility dictionary if CDD\$DEFAULT is not defined.
- For each object file generated by the compilation, the compiler creates a temporary file object. Each compiled module object contains a pointer to a file object, and several compiled module objects can point to the same file object. At the end of the compilation, the file object does not actually exist in the repository. However, information relating the compiled module object and the object file does exist in the repository.

The /DEPENDENCY\_DATA qualifier can also direct the compiler to create relationships between the compiled module object and other objects in the repository:

- If the source file contains a COPY FROM DICTIONARY statement, the compiler creates a CDD\$COMPILED\_DEPENDS\_ON relationship between the compiled module object and the record or field definition that is being copied. It also copies the repository object into the compiled module.

## Programming Productivity Tools

### C.5 Using Oracle CDD/Repository (OpenVMS)

- If the source file contains a RECORD statement, the compiler creates a relationship between the compiled module object and the specified repository object, but it does not copy the repository object into the compiled module. The relationship can be either CDD\$COMPILED\_DEPENDS\_ON or CDD\$COMPILED\_DERIVED\_FROM. The default relationship type is CDD\$COMPILED\_DEPENDS\_ON.

For example, recall the program that used COPY FROM DICTIONARY to include the customer and employee address record definitions:

```
IDENTIFICATION DIVISION.  
PROGRAM-ID. MASTER-FILE.  
DATA DIVISION.  
WORKING-STORAGE SECTION.  
COPY "DEVICE:[VMS_DIRECTORY]SALES.CUSTOMER_ADDRESS_RECORD" FROM DICTIONARY.  
COPY "DEVICE:[VMS_DIRECTORY]SALES.EMPLOYEE_ADDRESS_RECORD" FROM DICTIONARY.  
.  
.  
.
```

When this program is compiled with the /DEPENDENCY\_DATA qualifier, the following objects are created in the repository:

- A compiled module object called MASTER\_FILE
- A temporary file object representing the object file produced by the compilation
- A relationship between the MASTER\_FILE compiled module object and the object file
- A relationship between the MASTER\_FILE object and the CUSTOMER\_ADDRESS\_RECORD definition
- A relationship between the MASTER\_FILE object and the EMPLOYEE\_ADDRESS\_RECORD definition

In addition, the record definitions are included in the compiled module.

The COPY FROM DICTIONARY statement is used when you want to create a relationship between a compiled module and a record or field definition. The RECORD statement is used when you need to create a relationship between a compiled module and some other kind of repository object — one that you do not want copied into the compiled module. For example, suppose you need to create a relationship between the MASTER\_FILE compiled module object and a text file object, such as a functional specification. This relationship would indicate that the compiled module is derived from the functional specification. For example:

```
IDENTIFICATION DIVISION.  
PROGRAM-ID. MASTER-FILE.  
.  
.  
.  
PROCEDURE DIVISION.  
A0100.  
.  
.  
.  
RECORD DEPENDENCY "DEVICE:[VMS_DIRECTORY]SALES.SPECIFICATION"  
TYPE IS "CDD$COMPILED_DERIVED_FROM" IN DICTIONARY.  
.  
.  
.
```

## Programming Productivity Tools

### C.5 Using Oracle CDD/Repository (OpenVMS)

When this program is compiled with the /DEPENDENCY\_DATA qualifier, the compiler creates the following objects and relationships:

- A compiled module object called MASTER\_FILE
- A temporary file object representing the object file produced by the compilation
- A relationship between the MASTER\_FILE compiled module object and the object file
- A relationship between the MASTER\_FILE object and the repository object called SPECIFICATION, which represents the functional specification text file

For more information on the RECORD statement, refer to the *HP COBOL Reference Manual*. For more information on the /DEPENDENCY\_DATA qualifier, invoke the online help facility for COBOL at the operating system prompt.

#### C.5.4 Data Types

Oracle CDD/Repository supports some data types that are not native to HP COBOL. If a data definition contains a field declared with an unsupported data type, HP COBOL issues a fatal diagnostic. The HP COBOL compiler does not attempt to approximate a data type that it does not support.

Table C–1 shows how Oracle CDD/Repository data types are translated into COBOL data types. It also states the level of support HP COBOL provides for Oracle CDD/Repository data types.

**Table C–1 Oracle CDD/Repository Data Types: Level of Support in HP COBOL on OpenVMS**

Data Type	VAX	Alpha	I64
UNSPECIFIED	U	U	U
SIGNED BYTE	W	W	W
UNSIGNED BYTE	W	W	W
SIGNED WORD	S	S	S
UNSIGNED WORD	W	W	W
SIGNED LONGWORD	S	S	S
UNSIGNED LONGWORD	S	S	S
SIGNED QUADWORD	S	S	S
UNSIGNED QUADWORD	W	W	W
SIGNED OCTAWORD	W	W	W
UNSIGNED OCTAWORD	W	W	W
F_FLOATING	S	S	S
F_FLOATING COMPLEX	W	W	W

S—Fully supported

W—The data type is translated into a supported type and a diagnostic message is issued.

U—The data type is unsupported and a fatal diagnostic message is issued.

(continued on next page)

## Programming Productivity Tools

### C.5 Using Oracle CDD/Repository (OpenVMS)

**Table C-1 (Cont.) Oracle CDD/Repository Data Types: Level of Support  
in HP COBOL on OpenVMS**

Data Type	VAX	Alpha	I64
D_FLOATING	S	S	S
D_FLOATING COMPLEX	W	W	W
G_FLOATING	W	S	S
G_FLOATING COMPLEX	W	W	W
H_FLOATING	W	W	W
H_FLOATING COMPLEX	W	W	W
UNSIGNED NUMERIC	S	S	S
LEFT OVERPUNCHED NUMERIC	S	S	S
LEFT SEPARATE NUMERIC	S	S	S
RIGHT OVERPUNCHED NUMERIC	S	S	S
RIGHT SEPARATE NUMERIC	S	S	S
PACKED DECIMAL	S	S	S
ZONED NUMERIC	W	W	W
BIT	W	W	W
DATE	W	W	W
TEXT	S	S	S
VARYING STRING	W	W	W
POINTER	S	S	S
VIRTUAL FIELD	W	W	W
SEGMENTED STRING	W	W	W
REAL	U	S	S
ALPHABETIC	U	S	S

S—Fully supported

W—The data type is translated into a supported type and a diagnostic message is issued.

U—The data type is unsupported and a fatal diagnostic message is issued.

## Programming Productivity Tools

### C.5 Using Oracle CDD/Repository (OpenVMS)

#### C.5.5 For More Information

For more information about Oracle CDD/Repository, refer to the following manuals:

Document	Description
<i>Oracle CDD/Repository Architecture Manual</i>	Describes the concepts and capabilities of the Oracle CDD/Repository object-oriented architecture.
<i>Using Oracle CDD/Repository on OpenVMS Systems</i>	Provides tutorial information for Oracle CDD/Repository users
<i>Oracle CDD/Repository CDO Reference Manual</i>	Provides reference information for the Common Dictionary Operator (CDO) utility
<i>Oracle CDD/Repository Callable Interface Manual</i>	Explains how to use the ATIS callable interface
<i>Oracle CDD/Repository Information Model Volume I, CDD/Repository Information Model Volume II</i>	Contain reference information on the ATIS and Oracle CDD/Repository type hierarchy

◆



---

## Porting to HP COBOL from Other Compilers (Alpha, I64)

HP COBOL has built-in porting assistance that recognizes foreign COBOL extensions and helps you migrate programs from other systems. Porting assistance is always enabled for some foreign extensions. However, for those features that use new reserved words, this feature is selectively enabled at compile time by qualifiers and flags on the COBOL command line.

Porting assistance provides the following features:

- The ability to detect syntax from other COBOL implementations
- The process of applying foreign reserved words (in other words, from other COBOL implementations) in the presence of foreign COBOL extension syntax
- Messages to help you recode those program steps that use the foreign extensions
- Support for selected syntax synonyms used in other COBOL implementations

### D.1 Porting Assistance

HP COBOL porting assistance can help you port programs from other COBOL implementations to HP COBOL. It does so by recognizing and reporting occurrences of known extensions from other COBOL implementations that are not implemented in HP COBOL (hence “foreign” extensions).

*Some* porting assistance is always present. Foreign extensions that do not need new reserved words are always recognized and diagnosed as foreign extensions (or, in a few cases, implemented as new features of HP COBOL).

The default is for full porting assistance to be turned off, but you can enable it at compile time by adding the foreign extensions option to the COBOL command. The option can be negated by a NO prefix. It can be used in combination with other options, and is independent of those options. See Table 1–2, HP COBOL Command Flags on Tru64 UNIX and Table 1–4, COBOL Command Qualifiers for option syntax and defaults.

You enable full porting assistance by adding the foreign extensions option to the compile command as follows:

On OpenVMS

```
/RESERVED_WORDS=FOREIGN_EXTENSIONS
```

## Porting to HP COBOL from Other Compilers (Alpha, I64)

### D.1 Porting Assistance

On Tru64 UNIX

```
-rsv foreign_extensions
```

Without full porting assistance enabled, if you compile program source code that was written for a compiler other than HP COBOL, extensions that are not directly supported by HP COBOL are flagged with terse messages and the compile fails. Porting assistance will provide you with better diagnostics and more information that can assist you in recoding the indicated operations with HP COBOL syntax.

When full porting assistance is on, the compiler recognizes each occurrence of certain extensions from other COBOL implementations (shown in Table D–1), and outputs a diagnostic that identifies that foreign extension.

For example, your program might contain the following line:

```
EXAMINE Y REPLACING ALL "A" BY "Z".
```

In the absence of the porting assistance, the compiler will output this message:

```
Invalid statement syntax
```

The previous message is accurate, but does not lead you to a resolution.

If you enable porting assistance, you will receive a message that is much more helpful, as follows:

```
Foreign extensions, EXAMINE statement, not implemented  
Invalid statement syntax
```

The previous message clearly identifies the foreign statement (in this case, EXAMINE), so that you can replace it with the equivalent HP COBOL statement.

When full porting assistance is on, the reserved words shown in Table D–1 are added to those shown in the Reserved Words appendix in the *HP COBOL Reference Manual*.

**Table D–1 Recognized Foreign Reserved Words**

ADDRESS	CHANGED	CORE-INDEX	DBCS
DISP	DISPLAY-1	EJECT	ENTRY
EXAMINE	EXHIBIT	GOBACK	ID
KANJI	NAMED	NOTE	OTHERWISE
PASSWORD	POSITIONING	RECORDING	RECORD-OVERFLOW
RELOAD	REMARKS	REORG-CRITERIA	RETURNING
SERVICE	SKIP1	SKIP2	SKIP3
TRACE	TRANSFORM		

Ordinarily, the compiler simply treats a declaration of any of these words as a fatal error. The porting assistance option can issue a meaningful diagnostic message that can guide you to appropriate recoding.

Full porting assistance is placed under control of the foreign extensions option, rather than running at all times. Although the porting assistance is useful for porting many programs with foreign extensions, it is not useful with *all* programs, because the new reserved words may conflict with declared names and



produce fatal diagnostic messages for programs that have successfully compiled before.

## **D.2 Flagged Foreign Extensions**

HP COBOL porting assistance recognizes the foreign syntax shown in the following list and provides helpful diagnostic messages when they are encountered:

- ADDRESS OF in CALL statement
- ADDRESS OF in SET statement
- AFTER POSITIONING in WRITE statement
- EJECT statement
- ENTER statement
- ENTRY statement
- EXAMINE statement
- GOBACK statement
- ON statement
- PURGE statement
- RECEIVE statement
- SEND statement
- SERVICE statement
- SKIP statement
- TRANSFORM statement
- PASSWORD for SELECT statement
- DISPLAY-1 as PICTURE USAGE
- FILE STATUS with a second target
- LENGTH OF in CALL USING statement

The last two features in this list are always detected. All others in the list are under control of the foreign extensions option because they require recognition of foreign reserved words.

## **D.3 Implemented Extensions**

The following foreign extensions are implemented in HP COBOL to make it easier to port programs:

- ZEROES and ZEROS can be used in a BLANK WHEN ZERO clause.
- EQUAL can be used instead of the equal sign (=) in a COMPUTE statement.
- An empty INPUT-OUTPUT section is accepted and flagged with an Informational message, rather than issuing a Fatal message.
- The REMARKS paragraph can be used in the Identification Division.

The last feature in this list is under control of the foreign extensions option because it requires the foreign reserved word REMARKS. The other extensions are provided in HP COBOL. ♦



## A

---

2000 A.D.

date change problem, 1-63

a.out file, 1-3, 1-10, 1-12

ACCEPT/DISPLAY with file input or output,  
B-16

ACCEPT statement

See also Video forms

differences, B-15

ANSI, B-15

extensions to ANSI, B-16

EDITING phrase, 11-28

input, object of, 11-1

Access mode, 6-1

default, 6-23

dynamic, 6-23

indexed files, specifying for, 6-23

random, 6-23

relative files, specifying for, 6-23

sequential files, specifying for, 6-23

specifying, 6-23

switching, 6-44

Access mode switching

READ NEXT statement, 6-44

Access stream

definition, 8-2

ACMSxp, 1-8

ADVANCING phrase, 6-8

-align flag

HP COBOL support for, B-3

syntax of, 16-5

Alignment

along byte boundaries, 16-5

and SYNCHRONIZED clause, 16-8

changing with directives, 16-6, 16-7

\*DC END-SET ALIGNMENT, 16-6

\*DC SET ALIGNMENT, 16-6

\*DC SET NOALIGNMENT, 16-6

\*DC SET NOPADALIGN, 16-6

\*DC SET PADALIGN, 16-6

default for source file, 16-5

directives, 16-1, 16-6

syntax of, 16-6

for OpenVMS VAX compatibility, 16-4

for optimal performance, 16-4

natural, 16-3

Alignment (cont'd)

natural (tab.), 16-4

OpenVMS VAX compatible, 16-3

qualifiers, 16-4

specifying, 2-1

specifying natural, 16-5, 16-6

specifying OpenVMS VAX compatible, 16-5,  
16-6

/ALIGNMENT

syntax of, 16-5

Alignment (ex.), 16-8

/ALIGNMENT (Ex.), 16-10

/ALIGNMENT=padding, 1-25, 16-4, B-7

Alignment directives

and SYNCHRONIZED clause, 16-8

comparison, 16-9

nesting, 16-7

Alignment of data

Quadword boundary, 2-1, 3-3

run-time performance, 15-5

/ALIGNMENT qualifier, 4-7, 15-5

HP COBOL support for, B-3

operations order of precedence (fig.), 16-6

Alignment qualifiers, 16-5

and SYNCHRONIZED clause, 16-8

-align padding flag, B-7

-align [padding] flag, 1-5

ALLOWING (used with I-O verbs), 8-3

Alpha architecture

register set differences, B-17

(ex.), B-17

ALPHABET clause

value of numeric literals

compiler implementation specifications,  
A-1

Alternate key

definition, 6-7

segmented, 6-34

/ANALYSIS\_DATA, 1-25

/ANALYSIS\_DATA qualifier, C-14

-ansi flag, 1-5

ANSI format

See Developing programs

ANSI format source line

structure and content of, 1-52

- ANSI-to-terminal
  - format conversion, 14–2
- /ANSI\_FORMAT, 1–25
- APPLY clause, 6–21, 15–11
- APPLY LOCK-HOLDING, 8–3
- APPLY PRINT-CONTROL clause, 6–8, 6–12
- arch, 15–3
- arch flag, 1–5
- /ARCHITECTURE qualifier, 1–25, 15–3
- Archive library
  - creating and maintaining, 1–19
  - file name suffix, 1–3
  - obtaining information about, 1–19
  - specifying using COBOL, 1–12
- ar command, 1–19
- Argument list, 13–3
- Argument-passing mechanisms
  - BY CONTENT, 12–12
  - BY DESCRIPTOR, 12–12
  - BY OMITTED, 12–12
  - BY REFERENCE, 12–11
  - BY VALUE, 12–12
- Arguments
  - optional, 13–6, 13–11
  - run time command line, 1–16, 1–43
- Arithmetic, native, 2–10, 2–12
- Arithmetic, standard, 2–10, 2–12
- arithmetic flag, 1–5
- Arithmetic operations
  - results of rounding off, 2–13
- /ARITHMETIC qualifier, 1–25, 2–12, B–23
- Arithmetic statements, 2–9, 2–16
  - common errors, 2–15
  - temporary work items, 2–9
  - with GIVING phrase, 2–14
  - with SIZE ERROR phrase, 2–14
- Arrays
  - large
    - impact on compile, 1–48
- ASSIGN clause
  - file description, 6–14
  - overriding the file specification, 6–18
  - VALUE OF, 6–19, 6–20
  - VALUE OF ID clause, using with, 6–17
- ASSIGN DCL command, 1–61
  - using logical names, 6–18
- ASSIGN TO clause, 6–18
- ASSIGN TO PRINTER clause, 6–8, 6–12
- ASSIGN TO REEL clause
  - block size, A–3
  - number of files, A–3
  - number of magnetic tapes, A–3
  - record size, A–3
- AT END condition
  - planning for, 7–1
- Attributes
  - COBOL program, 12–3

- /AUDIT qualifier
  - number of strings
    - compiler implementation specifications, A–2

## B

---

- Backup procedures
  - files, 6–61
- Behavior differences
  - between HP COBOL on Alpha and I64 and VAX, B–9 to B–28
- Binary data
  - alignment, 15–5
- Binary data item
  - See also Data item, binary
  - advantages of, 15–6 to 15–7
- Binary search, 4–16 to 4–23
  - function and results, 4–18
  - requirements for, 4–18
  - with AT END statement, 4–18
  - with keys, 4–18
- BLOCK CONTAINS clause
  - disk media
    - compiler implementation specifications, A–3
  - magtape media
    - compiler implementation specifications, A–3
- Bottom margin, 10–13
- Boundaries, data, 16–4
- Bucket size
  - compiler implementation specifications, A–1
- Byte boundaries
  - effects on storage allocation, 4–7

## C

---

- C, calling from HP COBOL, 12–30
- Call frame
  - definition, 1–47
- Calling
  - sequence examples, 13–19 to 13–21
- Calling COBOL Programs from C on Tru64 UNIX, 12–33
- Calling C Programs from HP COBOL on Tru64 UNIX, 12–33
- Calling OpenVMS Alpha shareable images, 12–32
- Calling procedure, 12–2
- Calling routines, 13–5
- Calling subprograms
  - See Interprogram communication
- Calling Tru64 UNIX Shareable Objects, 12–32
- CALL statement
  - nesting, 12–6
  - transferring execution control, 12–5
  - use of, 12–5

- call\_shared flag, 1-5, 1-14
- Case sensitivity issues
  - on Tru64 UNIX, 12-32
- cc command
  - using cobol command instead of, 1-11
- CDD
  - See Oracle CDD/Repository
- CDO
  - data types supported, C-19
  - source representation, C-15
- CDO language, C-15
- Cell
  - contents, 6-5
  - location in the file, 6-6
  - numbering, 6-6
  - numerical order of, 6-6
  - relative record number, 6-6
  - size, 6-6
- Century date change, 1-63
- c flag, 1-5, 1-7
  - example, 1-11
- C flag, 1-5
- Character attributes for terminal screen, 11-8
- /CHECK, 1-25
- /CHECK=DECIMAL qualifier, 2-2
- /CHECK=DUPLICATE\_KEYS qualifier, 6-7
- check all flag, 1-5
- check decimal flag, 2-2
- check none flag, 1-5
- check [no]bounds flag, 1-5
- check [no]decimal flag, 1-5
- check [no]perform flag, 1-5
- CISC architecture, 1-47
- CIT3 data items, 2-10
- cit3 option, 1-6
- CIT4 data items, 2-10
- cit4 option, 1-6
- Class, 3-5
- CLASS-NAME, 3-5
- Class tests, 3-5
  - numeric, 2-4
- CMS
  - See Code Management System
- COB\$SWITCHES, 1-60
- cobcall, 12-22
- cobcall routine, 12-20
- cobcancel, 12-22
- cobcancel routine, 12-20
- cobfunc, 12-22
- cobfunc routine, 12-20
- COBOL, run-time errors
  - See Run-time messages
- COBOL and debugging, 1-23
- cobol command
  - and ld, 1-13
  - and other software components, 1-4
  - compiling multiple files, 1-10
  - cobol command (cont'd)
    - creating shared libraries, 1-14 to 1-15
    - driver, 1-4
    - examples
      - compiling multiple files, 1-11
      - using different suffix characters, 1-4
    - files created by, 1-10
    - format, 1-4
    - for use with the debugger, 1-9, 1-24
    - interpretation of suffix characters, 1-2
    - linking, 1-20
    - linking objects, 1-12 to 1-15
    - messages, 1-11
    - output files, 1-10
    - processes used by, 1-4
    - recognized source file name suffixes, 1-2
    - sample use with external subprogram, 1-3, 1-9
    - specifying directory for temporary files, 1-10
    - specifying input files, 1-4 to 1-9
    - specifying output file, 1-10
    - suffix characters and interaction with flags, 1-2
    - temporary files, 1-10
- COBOL command, 1-22 to 1-29
  - driver, 1-20
  - qualifiers, 1-24 to 1-29
- cobol command flags
  - list of, 1-5
- cobol flags
  - align [padding], 1-5
  - ansi, 1-5
  - arch, 1-5
  - arithmetic, 1-5
  - c, 1-5, 1-7
  - C, 1-5
  - call\_shared, 1-5
  - check all, 1-5
  - check none, 1-5
  - check [no]bounds, 1-5
  - check [no]decimal, 1-5
  - check [no]perform, 1-5
  - conditionals [selector], 1-5
  - convert [no]leading\_blanks, 1-5
  - copy, 1-5
  - copy\_list, 1-5
  - cord, 1-6
  - cross\_reference, 1-6
  - cross\_reference alphabetical, 1-6
  - cross\_reference declared, 1-6
  - display\_formatted, 1-6
  - D num, 1-6
  - feedback file, 1-6
  - fips 74, 1-6
  - flagger [option], 1-6
  - <foot-tune, 1-7
  - g0, 1-6
  - g1, 1-6
  - g2 or -g, 1-6

cobol flags (cont'd)

- g3, 1-6
- granularity byte, 1-6
- granularity long, 1-6
- granularity quad, 1-6
- include, 1-6
- K, 1-6
- L, 1-6
- Ldir, 1-6
- list, 1-6
- lstring, 1-6
- mach, 1-6
- machine\_code, 1-6
- map, 1-6
- map alphabetical, 1-6
- map declared, 1-6
- math\_intermediate, 1-6
- math\_intermediate cit4, 1-6
- names as\_is, 1-6
- names lower or -names lowercase flag, 1-6
- names upper or -names uppercase flag, 1-6
- nolocking, 1-6
- non\_shared, 1-6
- noobject, 1-6
- nowarn, 1-6
- O0, 1-6
- O1, 1-7
- O2, 1-7
- O3, 1-7
- O4 or -O, 1-7
- o output, 1-7
- p0, 1-7
- p1 or -p, 1-7
- relax\_key\_checking or -rkc, 1-7
- rsv, D-1
- rsv [no]200x, 1-7
- rsv [no]xopen, 1-7
- seq, 1-7
- sequence\_check, 1-7
- shared, 1-7
- show code, 1-7
- show copy, 1-7
- show xref, 1-7
- std, 1-7
- std 85, 1-7
- std v3, 1-7
- std [no]mia, 1-7
- std [no]syntax, 1-7
- std [no]xopen, 1-7
- taso, 1-7
- T num, 1-7
- tps, 1-7, 1-8
- trunc, 1-7
- v, 1-7
- V, 1-7
- w, 1-7
- warn, 1-7
- warn all, 1-7

cobol flags (cont'd)

- warn none, 1-7
- warn [no]information, 1-7
- warn [no]other, 1-7
- xref, 1-7
- xref\_stdout, 1-7
- COBOL qualifiers, list of, 1-24
  - /ALIGNMENT=[NO]PADDING, B-7
  - /ALIGNMENT=[NO]PADDING], 1-25
  - /ANALYSIS, 1-25
  - /ANSI\_FORMAT, 1-25
  - /ARCHITECTURE, 1-25
  - /ARITHMETIC, 1-25
  - /CHECK, 1-25
  - /CONDITIONALS, 1-25
  - /CONVERT, 1-25
  - /COPY\_LIST, 1-25
  - /CROSS\_REFERENCE, 1-25
  - /DEBUG, 1-26
  - /DEPENDENCY\_DATA, 1-26
  - /DIAGNOSTICS, 1-26
  - /DISPLAY\_FORMATTED, 1-26
  - /FIPS, 1-26
  - /FLAGGER, 1-26
  - /FLOAT, 1-26
  - /GRANULARITY, 1-26
  - /INCLUDE, 1-26
  - /KEEP, 1-27
  - /LIST, 1-27
  - /MACHINE\_CODE, 1-27
  - /MAP, 1-27
  - /MATH\_INTERMEDIATE, 1-27
  - /NAMES, 1-27
  - /NATIONALITY, 1-27
  - /OBJECT, 1-27
  - /OPTIMIZE, 1-27
  - /RESERVED\_WORDS, 1-28, D-1
  - /RESERVED\_WORDS=FOREIGN\_EXTENSIONS, 1-28
  - /SEPARATE\_COMPILATION, 1-24, 1-28, 1-51
  - /SEQUENCE\_CHECK, 1-28
  - /SOURCE, 1-28
  - /STANDARD, 1-28
  - /TIE, 1-28
  - /TRUNCATE, 1-28
  - /VFC, 1-28, B-15
  - /WARNINGS, 1-28
- COBOL\_SWITCHES, 1-60
- Code Management System
  - integration with LSE, C-12
- Coding
  - based on architectural differences, B-17
- COLLATING SEQUENCE IS, 9-7
  - Phrase, overriding a,
    - example, 9-7
- Command line
  - arguments, run time
  - OpenVMS Alpha, 1-43

- Command line
  - arguments, run time (cont'd)
    - Tru64 UNIX, 1-16
  - common HP COBOL errors, 1-29
- Command-line argument
  - accessing, 1-16
- Command-line arguments
  - accessing at run time, 1-43
- Command-line qualifiers, B-4 to B-9
  - HP COBOL for OpenVMS VAX only (tab.), B-7
  - HP COBOL only (tab.), B-6
  - shared, B-4
  - shared (tab.), B-4
- Comment symbol, 14-3
- COMMON clause, 12-15
- Common language environment
  - using COBOL in, 13-1
- Communication
  - See Interprogram communication
  - contained programs, 12-14
- Comparing operands, 3-5
- Compatibility
  - alignment for, 16-4
  - case sensitivity, 12-32
  - /CHECK=DUPLICATE\_KEYS, 6-7
  - compiling multiple source files, 1-9
  - compiling multiple source files on OpenVMS
    - Alpha, 1-23
  - errors on compile, 1-7
  - file compatibility, B-26
  - fixed-length records, B-27
  - ORGANIZATION INDEXED file, reading,
    - B-27
  - print-controlled files, B-26
  - reading COBOL indexed files, 6-46
  - variable-length records, B-27
  - VFC files, B-26
- COMP data item
  - advantages of, 15-6 to 15-7
- Compilation performance, 1-47
  - and physical memory, 1-50
  - and separate compilation, 1-51
  - and virtual memory, 1-49
- Compiled module entry, C-17
- Compiler
  - and linker, 1-20
  - diagnostic messages issued by
    - general description, 1-11
  - driver, 1-4, 1-20
  - error messages, 1-29
  - messages, 1-29
  - performance, 1-47
  - specifying directory for temporary files, 1-10
- Compiler directives
  - See also Alignment directives
  - binary data item, 16-3
- Compiler errors
  - example of, 1-30
  - hints to avoid them, 1-29
- Compiler implementation limitations
  - subscripts
    - number of levels, A-3
- Compiler implementation specifications, A-1 to A-3
  - ALPHABET clause
    - value of numeric literals, A-1
  - /AUDIT qualifier
    - number of strings, A-2
  - BLOCK CONTAINS clause
    - disk media, A-3
    - magtape media, A-3
  - bucket size, A-1
  - contained programs
    - nesting depth, A-2
  - data items
    - exceeding size of, A-2
  - EXTENSION option
    - value of integers, A-1
  - external report file
    - number of characters, A-2
  - FD record length, A-1
  - file connectors, A-1
  - hexadecimal literals, A-2
  - indexed file
    - number of key data items, A-1
  - index name
    - subscript value, A-3
  - intrinsic functions, digits, A-2
  - ISAM keys, digits, A-2
  - MERGE
    - number of USING files, A-2
  - multiblock count, A-1
  - MULTIPLE FILE TAPE clause
    - number of files, A-3
  - nested IF statements
    - static nesting depth, A-3
  - nonnumeric literals, A-2
  - number of literal phrases, A-1
  - numeric literal, digits, A-2
  - numeric SORT/MERGE keys, digits, A-2
  - OCCURS *n* TIMES clause
    - value of *n*, A-3
  - Oracle CDD/Repository pathname specification
    - number of characters, A-2
  - PERFORM *n* TIMES clause
    - value of *n*, A-3
  - physical block size, A-1
  - picture character string, characters in, A-2
  - PICTURE character-strings, A-2
    - alphanumeric or alphabetic, A-2
    - alphanumeric or numeric edited, A-2
  - PICTURE character strings, digits in fixed-point
    - numeric and numeric-edited items, A-2
  - record definitions, A-1

- Compiler implementation specifications (cont'd)
  - report file
    - number of lines, A-3
  - RESERVE AREAS clause
    - value of integers, A-1
  - run-time storage, A-1
  - SD record length, A-1
  - SORT
    - number of USING files, A-2
  - subscript name
    - subscript value, A-3
  - SWITCH clause
    - value of switch numbers, A-1
  - SYMBOLIC CHARACTERS clause
    - value of numeric literals, A-1
  - user-words
    - number of characters, A-2
  - USING phrase
    - number of operands, A-2
  - WINDOW option
    - value of integers, A-1
- Compiler listing files
  - definition, 1-31
  - multiple instances of source line, B-13
  - reading, 1-31 to 1-32
  - separate compilation, B-14
- Compiler messages
  - format, 1-29
  - interpreting, 1-31
- Compiling
  - and linking for debugging, C-7
  - for debugging, C-3
- Compiling programs, 1-22
  - C language file suffix, 1-3
  - C language with cobol, 1-11
  - compile command qualifiers, 1-24
  - compile command qualifiers (table), 1-24
  - conditional compilation, 1-29
  - /DEBUG, C-7
  - debugging, 1-23
  - error messages, 1-29
  - g -o, C-3
  - multiple source files on OpenVMS Alpha, 1-23, 1-24, 1-51
  - multiple source files on Tru64 UNIX, 1-9 on OpenVMS Alpha, 1-22
- COMP unsigned longword integers, 15-15
- Concatenating items
  - nonnumeric data, 5-1
- Conditional compilation lines, 1-29
- /CONDITIONALS, 1-25
- conditionals [selector] flag, 1-5
- Condition handler (ex.), 13-17
- Condition values
  - returned, 13-13
  - signaled, 13-13
- Contained program, 12-1
  - COMMON clause, 12-15
  - communication with, 12-14
  - nesting depth
    - compiler implementation specifications, A-2
    - reading listing files, 1-32
- CONTENT argument-passing mechanism, 12-12
- Continuation symbol (ANSI format), 14-3
- CONTINUE, DCL command, 1-62
- Control byte sequences, B-15
- Control footing, 10-4
- Control heading, 10-3
- CONTROL KEY IN phrase, 11-20
- Controlling index, 4-18
- Conventional report
  - double-spaced master listing (fig.), 10-12
  - 20-line logical page (fig.), 10-11
  - logical page, 10-5
  - page advancing, 10-7
- CONVERSION phrase, 11-9, 11-13
- /CONVERT, 1-25, 2-2
  - LEADING\_BLANKS option
    - HP COBOL support for, B-3
  - convert flag, 2-2
- Converting
  - HP COBOL for OpenVMS VAX programs, B-1
    - using the /STANDARD=OPENVMS\_AXP qualifier option, B-9
  - reference format
    - using REFORMAT, 1-52
  - convert [no]leading\_blanks flag, 1-5
  - copy flag, 1-5
- COPY FROM DICTIONARY statement, C-16
- COPY library names, conflicting, B-19
- COPY REPLACING statement
  - differences
    - line numbers in compiler listing files, B-13
- COPY statement, 1-21
  - accessing data definitions, C-16
  - differences, B-10
    - HP COBOL for OpenVMS VAX (ex.), B-11
    - HP COBOL on OpenVMS Alpha (ex.), B-10
    - inserting text midline, B-12
      - HP COBOL on OpenVMS Alpha (ex.), B-12
    - inserting text midline (ex.), B-12
    - multiple COPY statements, B-11
      - HP COBOL on OpenVMS Alpha (ex.), B-11
    - multiple COPY statments (ex.), B-12
  - example, C-16
- /COPY\_LIS, C-16
- /COPY\_LIST, 1-25
  - in compiler listing files, 1-32



- copy\_list flag, 1-5
- cord flag, 1-6
- Creating a New Sort Key
  - example, 9-17
- /CROSS\_REFERENCE, 1-25
  - in compiler listing files, 1-32
- cross\_reference alphabetical flag, 1-6
- cross\_reference declared flag, 1-6
- cross\_reference flag, 1-6
- CTRL/Z key
  - use with LSE, C-13

## D

---

- Data dictionary, C-15
- Data Division
  - accessing another program's, 12-10
- Data errors
  - program run errors, 1-52
- Data items
  - Alpha and I64 alignment, 16-4
  - binary
    - alignment of, 16-3
    - natural alignment of, 16-5
  - exceeding size of
    - compiler implementation specifications, A-2
  - index, 4-16
  - intermediate, 15-8
  - padding, 16-4
- Data movement, 3-6, 3-12
- Data name, subscript with, 4-14
- Data organization, 3-2
- Data testing, 3-3, 3-6
- Data types, 13-8
  - HP COBOL-to-Oracle CDD/Repository mapping, C-19 to C-20
  - scaling and mixing, 15-7
  - selection for performance, 15-8
- DATE-COMPILED statement
  - differences, B-14
    - HP COBOL for OpenVMS VAX (ex.), B-14
    - HP COBOL on OpenVMS Alpha (ex.), B-14
  - listing multiple instances of source line, B-13
- \*DC, 16-1, 16-6
- DCL commands
  - ASSIGN, 1-61
  - CONTINUE, 1-62
  - DEASSIGN, 1-62
  - DEFINE, 1-61, 1-62
    - for program development, 1-20 to 1-32
- DCL SORT, 9-9
- \*DC SET NOPADALIGN, 16-6
- \*DC SET PADALIGN, 16-6
- DEASSIGN, DCL command, 1-62
  - using logical names, 6-18

- /DEBUG, 1-26
  - RUN command, 1-46
  - symbol table information, 1-46
- Debugger, 1-52, C-1 to C-11
  - COBOL support, C-6
  - compiling and linking with the debugger, C-7
  - compiling with the debugger, C-3
  - debugging optimized images, C-7
  - getting help, C-3, C-6
  - getting started, C-7
  - sample cobol command, 1-9, 1-24
  - use of conditional compilation lines, 1-54
  - use of desk-checking, 1-52
  - use of faulty data, 1-52
  - using conditional compilation lines, 1-29
  - using listing files, 1-31
- Debugging
  - OpenVMS Alpha, C-6 to C-11
    - sample session, C-7 to C-11
  - sample Ladebug Debugger session, C-3
  - sample source code, C-2
  - tools, C-1
  - Tru64 UNIX, C-3 to C-6
    - sample session, C-3 to C-6
- /DEBUG qualifier, C-7
  - and /OPTIMIZE, 15-5
- Decimal shadowing, 15-4, 15-5
- Declarative procedure (ex.), 7-9
- Declarative USE procedures
  - example, 7-9
  - EXTEND, 7-10
  - file name, 7-9
  - global, 7-9
  - INPUT, 7-9
  - INPUT-OUTPUT, 7-10
  - ordinary, 7-9
  - OUTPUT, 7-10
  - samples, 7-10
  - use of, 1-55
  - using, 7-8
- De-editing, 2-6, 2-7
- Default object module libraries
  - using the DEFINE command, 1-35
- DEFAULT phrase, 11-17
- Default user libraries
  - definition, 1-35
- DEFINE, DCL command, 1-61, 1-62
- Defining tables, 4-1 to 4-9
- Dependency recording, C-17
- /DEPENDENCY\_DATA, 1-26
- /DEPENDENCY\_DATA qualifier, C-17
- DESCRIPTOR
  - argument-passing mechanism, 12-12
- Design comments
  - unsupported by HP COBOL, B-4
- /DESIGN qualifier
  - unsupported by HP COBOL, B-4

- Desk-checking, 1-52
- Detail lines, 10-4
- Developing programs, 1-1
  - choosing a reference format, 1-51, 1-52
  - converting reference format, 1-52
  - creating a program, 1-20
  - editors, 1-20
  - reference format, 1-52
- Diagnostic messages
  - compiler, 1-29
  - linker
    - See Linker messages
  - run-time
    - See Run-time messages
- /DIAGNOSTICS, 1-26
- Directives
  - See also Alignment directives
  - data alignment
    - placement, 16-1
  - memory allocation and access, 16-3
  - SET VOLATILE, 16-3
- DISPLAY data items, avoiding for arithmetic, 15-6
- DISPLAY statement
  - See also Video forms
  - differences, B-15
  - output, object of, 11-1
- DISPLAY within ACCEPT ON EXCEPTION, terminating, 11-13
- /DISPLAY\_FORMATTED, 1-26
- display\_formatted flag, 1-6
- /DISPLAY\_FORMATTED qualifier, 11-12
- D num flag, 1-6
- Double-precision data
  - storage differences, B-20
- Driver
  - definition of, 1-4, 1-20
  - relationship to software components, 1-4, 1-20
- Driver program
  - and ld, 1-13
- Duplicate keys check, 6-7
- DUPLICATES IN ORDER phrase, 9-6
- Dynamic access mode
  - specifying, 6-21

## E

---

- EBCDIC
  - and SEARCH ALL, 15-10
- Edited moves
  - nonnumeric data, 3-9
- Editing
  - numeric symbols, 2-7
- EDITING phrase, 11-28
- Editors, 1-21
  - See Developing programs
- Elementary data items
  - nonnumeric, 3-2
- Elementary moves
  - nonnumeric, 3-7
  - numeric-edited, 2-7
- END-DISPLAY, B-16
- END-DISPLAY phrase, 11-13
- END-SET ALIGNMENT directive
  - syntax of, 16-6
- END-SET PADALIGN, 16-6
- END-SET VOLATILE directive
  - syntax of, 16-3
- Entry point
  - main, 1-16
- Environment variable, 6-18
  - accessing at run time, 1-17
  - COBOL\_INPUT, 11-2
  - COBOL\_OUTPUT, 11-2
  - compiler
    - specifying directory for temporary files, 1-10
  - stdin, 11-2
  - stdout, 11-2
  - TMPDIR, 1-10
- Erasing
  - a line on the terminal screen, 11-4
  - entire terminal screen, 11-4
  - to end of line on terminal screen, 11-5
  - to end of terminal screen, 11-5
- Error messages
  - compiler, 1-29
  - linker
    - See Linker messages
  - REFORMAT Utility, 14-4
  - run-time
    - See Run-time messages
- Errors
  - common HP COBOL command line, 1-29
  - compiler
    - effect on linker, 1-16
  - I/O, 1-55
  - in arithmetic statements, 2-15
  - in MOVE statements, 2-9
  - in size, 2-14
  - inspecting data, 5-33
  - linker messages, 1-16
  - nonnumeric MOVE statements, 3-11
  - run-time, 1-47
  - run-time input/output, 1-55
  - STRING statements, 5-6
  - unstringing data, 5-16
- Exception condition
  - definition, 1-46
- Executable programs
  - creating using cobol command, 1-3
  - installing using Tru64 UNIX tools, 1-19

- Execution control
  - transferring, 12-5
- EXIT PROGRAM statement
  - use of, 12-8
- Extending files
  - line sequential, 6-51
  - sequential, 6-51
- EXTENSION option
  - value of integers
    - compiler implementation specifications, A-1
- Extensions, detecting foreign, D-1
- EXTERNAL clause
  - use of, 12-5
- External report file
  - number of characters
    - compiler implementation specifications, A-2

## F

---

- FD record length
  - compiler implementation specifications, A-1
- feedback file flag, 1-6
- File
  - See also Access mode and Record
  - ACCEPT and DISPLAY statements, 11-1
  - ACCEPT statement, 11-2
  - backing up, 6-61
    - recommended intervals, 6-61
  - changing output file names (cobol), 1-10
  - closing
    - with lock, 6-26
  - connector, 6-14
  - created by cobol, 1-10
  - creating, 6-25
  - data type differences, B-27
  - defining a disk, 6-15
  - defining a disk file, 6-15
  - defining a magnetic tape file, 6-16
  - defining a magnetic tape file (on Tru64 UNIX), 6-17
  - definition, 6-1
  - description entry, 6-14
  - design considerations, 6-13
  - device independence
    - using logical names, 6-18
  - disk, defining a, 6-14, 6-15
  - DISPLAY statement, 11-2
  - fixed-length records, 6-9
  - handling, 6-1 to 6-61
  - identifying, 6-14
  - input to cobol, 1-8 to 1-9
  - logical names, 11-1
  - low-volume I/O, 11-1
    - logical names, 11-1
  - magnetic tape, defining a, 6-15, 6-16

- File (cont'd)
  - magnetic tape, defining a (on Tru64 UNIX), 6-17
  - mnemonic names, 11-1
  - multiple openings in same program, 6-25
  - object files created by cobol, 1-10
  - opening, 6-25
  - optimization, 15-11
  - processing, 6-1, 6-25
  - reading, 6-37
  - record access mode, specifying, 6-23
  - record management, 6-1
  - retaining object files cobol, 1-10
  - sharing
    - See File sharing
  - SPECIAL-NAMES paragraph, 11-1
  - specifying file organization, 6-20
  - specifying record mode access, 6-20
  - temporary cobol, 1-10
  - unusable, 6-61
  - updating, 6-49
  - variable-length records, 6-10
  - variable with fixed control records, 6-12
- File characteristics
  - specifying additional, 6-21
- file command, 1-19
- File connector
  - compiler implementation specifications, A-1
  - definition, 6-14
  - SELECT statement, 6-14
- File description, 6-2, 6-9, 6-14, 6-20
  - indexed files, 6-7
  - SELECT statement, 6-14
- File handling
  - Line sequential, 6-26
  - Sequential, 6-26
- File I/O status, checking, 1-55
  - Declarative USE procedure, 1-55
  - INVALID KEY condition, 1-55
- File name suffix
  - and source form, 1-2
  - for modules, 1-2
- File organization, 6-1
  - advantages and disadvantages (tab.), 6-2
  - comparing and contrasting, 6-2
  - default, 6-20
  - indexed, 6-2
  - indexed files, specifying for, 6-20
  - line sequential, 6-2
  - line sequential files, specifying for, 6-20
  - relative, 6-2
  - relative files, specifying for, 6-20
  - sequential, 6-2
  - sequential files, specifying for, 6-20
  - specifying, 6-2
  - using SELECT statement, 6-20

File protection, using, 8–4

File sharing, 8–1 to 8–16

- See also Protecting records and Record locking
- checking file operations, 8–12
- concepts, 8–1
- definition, 8–2
- describing types of access streams, 8–9
- determining the access mode, 8–6
- HP standard, 8–3
- indicating the access allowed to other streams, 8–8
- specifying OPEN EXTEND, 8–15
  - with a shared indexed file, 8–16
  - with a shared relative file, 8–15
  - with a shared sequential file, 8–15
- successful, 8–4
- summarizing related file-sharing criteria, 8–9
- using file status values, 8–12
- using RMS special registers, 8–12
- X/Open standard, 8–3

File specification

- creating a “comma list”, 1–23
- creating a “plus list”, 1–23
- how the I/O system builds a COBOL, 6–25
- keeping as a variable, 6–18
- overriding at run-time, 6–18
- variable, 6–18

File status values, 8–12

- differences, B–21
- for HP COBOL, 7–3
- for RMS, 7–5
- HP COBOL support for, B–4
- RMS-STS values, 8–14
- using, 7–3

/FIPS, 1–26

Fixed-length records, 6–9

- defining
  - with multiple record descriptions, 6–12
- determining size, 6–9
  - with multiple record descriptions, 6–10

/FLAGGER, 1–26

- in compiler listing files, 1–32

-flagger [option] flag, 1–6

flags

- align, 4–7
- align [padding], 1–5
- ansi, 1–5
- arch, 1–5
- arithmetic, 1–5
- c, 1–5, 1–7
- C, 1–5
- call\_shared, 1–5
- check all, 1–5
- check none, 1–5
- check [no]bounds, 1–5
- check [no]decimal, 1–5
- check [no]perform, 1–5
- compiler command line, 1–5 to 1–8

## flags (cont'd)

- conditionals [selector], 1–5
- convert [no]leading\_blanks, 1–5
- copy, 1–5
- copy\_list, 1–5
- cord, 1–6
- cross\_reference, 1–6
- cross\_reference alphabetical, 1–6
- cross\_reference declared, 1–6
- display\_formatted, 1–6
- D num, 1–6
- feedback file, 1–6
- fips 74, 1–6
- flagger [option], 1–6
- g, C–3
- g0, 1–6
- g1, 1–6
- g2 or -g, 1–6
- g3, 1–6, C–3
- granularity byte, 1–6
- granularity long, 1–6
- granularity quad, 1–6
- include, 1–6
- K, 1–6
- L, 1–6
- Ldir, 1–6
- list, 1–6
- lstring, 1–6
- mach, 1–6
- machine\_code, 1–6
- map, 1–6
- map alphabetical, 1–6
- map declared, 1–6
- math\_intermediate, 1–6
- math\_intermediate cit4, 1–6
- names, 12–32
- names as\_is, 1–6, 12–32
- names lowercase, 12–32
- names lower or -names lowercase flag, 1–6
- names uppercase, 12–32
- names upper or -names uppercase flag, 1–6
- nolocking, 1–6
- non\_shared, 1–6
- noobject, 1–6
- nowarn, 1–6
- O0, 1–6
- O1, 1–7
- O2, 1–7
- O3, 1–7
- O4 or -O, 1–7
- o output, 1–7
- p0, 1–7
- p1 or -p, 1–7
- relax\_key\_checking or -rkc, 1–7
- rsv foreign\_extensions, D–1
- rsv xopen, 1–7
- rsv [no]200x, 1–7
- seq, 1–7

## flags (cont'd)

- sequence\_check, 1-7
  - shared, 1-7
  - show code, 1-7
  - show copy, 1-7
  - show xref, 1-7
  - std, 1-7
  - std 85, 1-7
  - std v3, 1-7
  - std [no]mia, 1-7
  - std [no]syntax, 1-7
  - std [no]xopen, 1-7
  - taso, 1-7
  - T num, 1-7
  - tps, 1-7, 1-8
  - trunc, 1-7
  - tune, 1-7
  - v, 1-7
  - V, 1-7
  - w, 1-7
  - warn, 1-7
  - warn all, 1-7
  - warn none, 1-7
  - warn [no]information, 1-7
  - warn [no]other, 1-7
  - xref, 1-7
  - xref\_stdout, 1-7
- ## Flags
- align, B-3
  - align padding, B-7
  - with no HP COBOL for OpenVMS VAX  
equivalent qualifiers, B-6
- ## /FLOAT, 1-26
- ## Floating-point data types, 15-8
- ## /FLOAT qualifier
- HP COBOL support for, B-3
- ## Footing area, 10-13
- ## Foreign extensions, detecting, D-1
- ## Foreign syntax
- recognized extensions, D-2
- ## FOREIGN\_EXTENSIONS option, 1-28, D-1
- ## Format
- conversion of ANSI to terminal, 14-2
  - conversion of terminal to ANSI, 14-3
  - running the REFORMAT utility, 14-1
- ## Form control bytes, 6-12
- ## Forms
- See Video forms
- ## Fortran, calling from HP COBOL, 12-27, 12-28
- ## Function calls
- for system routines, 13-11
- ## Functions, 13-1
- ## Function value returned, 13-3

## G

---

- g0 flag, 1-6
- g1 flag, 1-6
- g2 or -g flag, 1-6
- g3 flag, 1-6
- g flag, C-3
  - and optimizing, 15-5
- GIVING phrase, 9-3
  - example, 2-14
- GLOBAL clause
  - and special registers, 12-19
  - definition of, 12-16
  - sharing data with, 12-16
  - sharing files with, 12-16
  - sharing other resources, record-name, 12-19
  - sharing other resources, report-name, 12-19
  - usage, 12-16
- /GRANULARITY, 1-26, 16-1
  - syntax of, 16-1
- granularity flag, 16-1
  - byte, 1-6
  - long, 1-6
  - quad, 1-6
  - syntax of, 16-1
- /GRANULARITY qualifier
  - restrictions on use, 16-2
- GROUP INDICATE clause, 10-87
  - results of (tab.), 10-87
- Group items, 3-2
  - nonnumeric, 3-2
- Group moves
  - nonnumeric data, 3-7

## H

---

- ## Handling record operations
- using RMS special registers, B-21
- ## HELP debugger command, C-6
- ## Hexadecimal literals
- compiler implementation specifications, A-2
- ## HP COBOL
- command-line flags
    - more information, B-4
  - command-line qualifiers
    - more information, B-4
    - new, B-6
    - new (tab.), B-6
  - compatibility
    - ACCEPT statement, B-15
    - arithmetic operations, B-22
    - between Alpha and VAX, B-1
    - calling shareable images, B-22
    - COPY statement, B-10
    - DBMS support, B-28
    - /DEBUG qualifier, B-28
    - DECset/LSE, B-28

## HP COBOL

- compatibility (cont'd)
  - diagnostic messages, B-19
  - DISPLAY statement, B-15
  - divide-by-zero, B-19
  - extensions and features, B-3
  - file attribute checking, B-25
  - file sharing and record locking, B-24
  - file status values, B-21
  - flags, B-5, B-8
  - indexed files, B-26
  - LINAGE clause, B-16
  - module names, B-10
  - MOVE statement, B-16
  - Multistream Oracle CODASYL DBMS
    - DML, B-29
    - /NATIONALITY=JAPAN, B-5
    - /NATIONALITY=US, B-5
    - on Tru64 UNIX and OpenVMS Alpha, B-24
  - Oracle CODASYL DBMS, B-28
    - program structure, B-9
    - qualifiers, B-5, B-8
    - REPLACE statement, B-13
    - REWRITE, B-24
    - RMS special registers, B-21, B-26
    - SEARCH statement, B-17
    - sharing common blocks, B-22
    - SHR, B-22
    - /STANDARD=V3, B-8
    - statements, differences in, B-15
    - std v3, B-8
    - storage of double-precision data, B-20
    - system return codes, B-17
    - VFC file format, B-25
    - /WARNINGS=ALL, B-8
  - debugger support, C-6
  - differences between Alpha and VAX, B-1
  - features
    - partial list of, B-3
  - source form
    - file name suffix, 1-2
- HP COBOL compiler
  - function, 1-22
- HP COBOL for OpenVMS VAX
  - command-line qualifiers
    - more information, B-4
    - new, B-7
    - new (tab.), B-7
  - features unsupported by HP COBOL on Alpha and I64, B-4
- HP COBOL on Alpha
  - compatibility
    - machine code listing, B-10
- HP standard file sharing, 8-3
- HP standard record locking, 8-3

## Hypersort, 9-9, 15-10, A-3

### I

---

- I/O device
  - accessing at run time, 1-45
- I/O errors, 1-55
- I/O exception conditions handling, 7-1 to 7-12
- I/O handling
  - AT END condition, 7-1
  - INVALID KEY condition, 7-2
    - using Declarative USE procedures, 7-8
    - using file status values, 7-3
    - using RMS completion codes, 7-3
- I/O operations
  - differences with RMS special registers, B-21, B-26
- I/O statements
  - and Screen Section video forms, 11-31
  - and video forms, 11-3
  - low-volume, 11-1
- I/O system, 6-1
  - building a COBOL file specification, 6-25
- Image activation optimization, 15-25
- /INCLUDE, 1-26
- include flag, 1-6
- Index data item, 4-16
  - declaration, 4-16
  - modifying with SET, 4-16
  - where defined, 4-3
- Indexed file
  - See also Optimization
  - access modes, 6-34
  - alternate key, 6-7
  - and ISAM mapping, 6-48
  - AT END condition, 7-1
  - capabilities, 6-6
  - creating, 6-32
  - creating and populating, 6-33
  - defining, 6-22
  - design considerations, 6-13
  - I/O statements, 6-33
  - index, 6-7
  - invalid key condition, 7-2
  - INVALID KEY condition, 7-2
  - key, 6-6
    - duplicate, 6-7
    - length, 6-6
    - location, 6-6
  - number of key data items
    - compiler implementation specifications, A-1
  - open modes, 6-34
  - optional key, 6-7
  - organization, 6-6
    - advantages, 6-3
    - disadvantages, 6-3
    - specifying, 6-21

- Indexed file (cont'd)
  - organization (fig.), 6-7
  - populating, 6-32
  - primary key, 6-7
  - processing, 6-33
  - reading, 6-41
    - dynamically, 6-44
      - example, 6-45
      - with READ PRIOR, 6-46
    - randomly, 6-42
      - example, 6-44
    - sequentially, 6-41
      - example, 6-42
  - reading from other language, 6-48
  - reorganizing, 6-33
  - SELECT statements, 6-24
  - specifying file organization and access mode, 6-22
  - updating, 6-56
    - random access mode, 6-57
    - sequential access mode, 6-56
  - updating records
    - dynamically, 6-60
    - randomly, 6-58
      - example, 6-60
    - sequentially, 6-57
      - example, 6-58
  - valid I/O statements (tab.), 6-34
  - writing, 6-34
- Indexes, 4-1
  - initializing, 4-15
- Indexing
  - advantages, 15-9
  - efficiency order, 15-9
- Indexing compared with subscripting, 15-9
- Index name
  - subscript value
    - compiler implementation specifications, A-3
- INITIAL clause
  - use of, 12-4
- Initializing
  - tables, 4-10 to 4-12
- INPUT and OUTPUT PROCEDURE phrases
  - example, 9-4
- Inspecting data
  - active/inactive arguments, 5-22
  - BEFORE/AFTER, 5-18
  - finding a match, 5-23
  - implicit redefinition, 5-18
  - INSPECT operation, 5-21
  - interference in tally argument list, 5-27
  - REPLACING, 5-30
  - scanner setting, 5-22
  - tally argument, 5-24
  - tally counter, 5-24
  - TALLYING phrase, 5-24
- INSPECT statement, 5-17 to 5-33
  - AFTER, 5-18
  - BEFORE, 5-18
  - common errors, 5-33
  - CONVERTING, 5-33
  - function, 5-17
  - how the INSPECT statement inspects data, 5-21
  - implicit redefinition, 5-18
    - values resulting from (tab.), 5-19
  - relationship among INSPECT argument, delimiter, item value, and argument active position (tab.), 5-22
  - REPLACING option, 5-17
  - REPLACING phrase
    - interference in the replacement argument list, 5-32
    - replacement argument, 5-31
    - replacement argument (fig.), 5-31
    - replacement argument list, 5-31
    - replacement value, 5-31
    - sample (fig.), 5-21
    - search argument, 5-30
  - sample (fig.), 5-21
  - TALLYING option, 5-17
  - TALLYING phrase, 5-24
    - argument list, 5-25
    - arguments, 5-24
    - counter, 5-24
    - interference in the tally arguemnt list, 5-27
    - leading delimiter of operation (tab.), 5-25
    - scan with separate tallies
      - results of (tab.), 5-26
- Interference
  - in replacement argument list, 5-32
  - in tally argument list, 5-27
- Intermediate data items, 15-8
- Intermediate result item, 2-10
- Interprogram communication, 12-1 to 12-34
  - See also Calling routines
    - accessing another program's Data Division, 12-10
    - Linkage Section, 12-13
    - USING phrase, 12-11
  - additional information on, 12-34
  - argument list, 13-3
  - calling COBOL programs, 12-20
  - calling non-COBOL programs, 12-26
    - example, 12-28
  - calling routines, 13-5
    - defining the argument, 13-6
    - determining the type of call, 13-5
    - locating the result, 13-15
    - making the call, 13-7
  - calling system service routines, 13-8
    - checking condition values, 13-13
    - EXTERNAL phrase, 13-13

Interprogram communication  
 calling system service routines (cont'd)  
   in a procedure call, 13–13  
   library return status, 13–15  
   VALUE IS clause, 13–13  
 calling system service routines condition value symbols, 13–15  
 CALL statement  
   passing arguments, 12–11  
 common language environment, 13–1  
   using COBOL in, 13–1  
 contained programs, 12–14  
   COMMON clause, 12–15  
   GLOBAL clause, 12–16  
   sharing data, 12–16  
   sharing files, 12–16  
   sharing other resources, 12–19  
   USE procedures, 12–17  
 examples, 13–19  
 function value, 13–3  
 multiple run unit concepts, 12–1  
   calling procedures, 12–2  
   definition, 12–1  
 multiple run unit examples, 12–1  
 OpenVMS Alpha Calling Standard, 13–2  
 OpenVMS Run-Time Library routines, 13–4  
 OpenVMS System Services routines, 13–4  
 program attributes, 12–3  
   EXTERNAL clause, 12–5  
   INITIAL clause, 12–4  
 register and stack usage, 13–2  
 restrictions on, 12–31  
 shareable images, 12–32  
 supplementary information on, 12–31  
 transferring execution control, 12–5  
   CALL statement, 12–5  
 transferring flow of control  
   CALL statement, 12–5  
   nesting, 12–6  
   EXIT PROGRAM statement, 12–8  
 Invalid key condition  
   planning for, 7–2  
 INVALID KEY phrase  
   use of, 1–55  
 I-O-CONTROL paragraph, 8–20, 15–10 to 15–15

## J

---

Justified moves  
 nonnumeric data, 3–9  
 truncation of data, 3–9

## K

---

/KEEP, 1–27  
 Key codes, 11–24

Keypad keys, 11–20  
 Keys  
   ascending, 4–5  
   descending, 4–5  
   segmented, 6–34  
 -K flag, 1–6

## L

---

Labels  
   printing four-up (ex.), 10–82  
   printing four-up (fig.), 10–82  
   printing four-up in sort order (ex.), 10–84  
   printing four-up in sort order (fig.), 10–84  
 Language-Sensitive Editor, C–12  
 Language Sensitive Editor (LSE)  
   Program Design Facility (PDF)  
     unsupported by HP COBOL, B–4  
 -Ldir flag, 1–6, 1–13  
 ld linker  
   creating shared object libraries, 1–14 to 1–15  
   functions performed, 1–12  
   locating undefined symbols using nm, 1–13  
   messages, 1–16  
   relationship to cob command, 1–12  
   relationship to cobol command, 1–13, 1–20  
   restrictions creating shared libraries, 1–15  
   sample use with cobol command, 1–3, 1–9  
   specifying object libraries, 1–12 to 1–14  
   specifying shared object libraries, 1–15  
 -L flag, 1–6, 1–13  
 LIB\$ESTABLISH routine, 13–15  
   user-written condition handler (ex.), 13–17  
 LIB\$INITIALIZE problem, B–27  
 lib\$K\_\* symbols, 13–21  
 LIB\$REVERT routine, 13–15  
 LIB\$\_\* symbols, 13–21  
 Libraries  
   condition value symbols, 13–15  
   default user object modules, 1–35  
   object modules, 1–35  
   return status, 13–15  
   system, 1–37  
   system-supplied object module libraries, 1–36  
   user-created object module libraries, 1–35  
 LINAGE clause, 6–8  
   differences, B–16  
   handling large values, B–16  
   using with WRITE statement, B–16  
   programming a 20-line logical page (ex.), 10–21  
   usage, 10–14  
 LINAGE-COUNTER special register, 10–14  
 Linage-file report  
   bottom margin, 10–13  
   footing area, 10–13  
   20-line logical page (fig.), 10–20  
   28-line logical page (fig.), 10–15  
   logical page, 10–13



- Linage-file report (cont'd)
    - logical page areas (fig.), 10–13
    - makeup, 10–12
    - page advancing, 10–14
    - page body, 10–13
    - page-overflow condition, 10–15
    - printing a, 10–19
    - top margin, 10–13
  - LINE-COUNTER option, 10–29
  - Line sequential file
    - creating, 6–26, 6–27
    - extending, 6–51
    - organization of, 6–4
      - advantages, 6–3
      - disadvantages, 6–3
    - organization of (fig.), 6–4
    - processing, 6–27
    - reading, 6–37
    - record format, 6–8
    - rewriting records in, 6–49
    - specifying file organization and access mode, 6–23
    - updating, 6–49
    - writing, 6–29
    - writing records from, 6–29
  - LINKAGE SECTION items
    - and USE procedures; effect on optimization, 15–10
    - description, 12–13
    - example, 12–13
  - LINK command, 1–33
    - See also LINK qualifiers
    - qualifiers, 1–33 to 1–34
    - syntax, 1–33
  - LINK command qualifiers
    - /SHARE, 1–42
  - Linker
    - errors
      - example of, 1–43
      - hints to avoid them, 1–42
    - messages, 1–42
      - format, 1–42
      - interpreting, 1–42
  - Linking programs, 1–12, 1–32
    - See also LINK command
    - /DEBUG, C–7
    - on OpenVMS Alpha, 1–33
    - on Tru64 UNIX, 1–12
    - using object module libraries, 1–35
    - using shareable images, 1–37
    - using system-supplied object module libraries, 1–36
    - using user-created object module libraries, 1–35
    - with non HP COBOL modules, 1–34
  - LINK qualifiers
    - /INCLUDE, object module library, 1–35
    - list of, 1–33
    - /SHARE, 1–37, 1–39
    - shareable images, 1–37
  - /LIST, 1–27, C–16
    - list flag, 1–6
  - Listing files
    - compiler, 1–31
    - contained program, 1–32
    - debugging programs, 1–31
    - separate compilation, B–14
  - Literal phrases
    - number of
      - compiler implementation specifications, A–1
  - Literal subscripts
    - accessing tables, 4–13
    - definition, 4–13
  - Locking records
    - See Protecting records
  - Logical
    - accessing at run time, 1–44
  - Logical name, 6–18 to 6–20
    - COB\$INPUT, 11–2
    - COB\$OUTPUT, 11–2
    - for file, 11–1
    - implementor name, 11–1
    - SYS\$INPUT, 11–2
    - SYS\$OUTPUT, 11–2
  - Logical page
    - conventional report, 10–5
    - definition, 10–5
    - presentation order (fig.), 10–26
    - spacing, 10–5
    - structure, 10–5
  - Logic errors, B–9
    - program run errors, 1–54
  - LSE
    - compiling source code, C–14
    - defined, C–12
    - entering source code, C–13
    - exiting, C–13
    - features of, C–12
    - invoking, C–13
    - product, 15–7, C–12
  - lstring flag, 1–13
    - and creating shared libraries, 1–15
  - lstring flag, 1–6
- ## M
- 
- mach flag, 1–6
  - Machine code in listings, B–10
  - /MACHINE\_CODE, 1–27
    - in compiler listing files, 1–32

- machine\_code flag, 1–6
- make command, 1–19
- Makefile, 1–19
- /MAP, 1–27
  - in compiler listing files, 1–32
- map alphabetical flag, 1–6
- map declared flag, 1–6
- map flag, 1–6
- math\_intermediate cit4 flag, 1–6
- math\_intermediate flag, 1–6
- /MATH\_INTERMEDIATE qualifier, 2–10, B–23
- Memory
  - allocation, 16–1
  - management, 16–3
  - usage, 16–3
- MERGE statement, 9–10
  - example, 9–10
  - number of USING files
    - compiler implementation specifications, A–2
  - sample programs, 9–10
- Merging files
  - example, 9–19
- Messages
  - issued by compiler
    - general description, 1–11
  - linking, 1–16
  - REFORMAT Utility error, 14–4
- Migration of programs, D–1
- Millennium date change, 1–63
- Module names, B–10
- Modules and file name suffix, 1–2
- MOVE CORRESPONDING statement, 3–11
- MOVE statement, 2–6, 3–7
  - common errors, 2–9
  - differences, B–16
    - referencing signed data items, B–16
    - referencing unsigned data items, B–16
  - differences (ex.), B–16
  - numeric, 2–6
- Moving
  - signed data items
    - size considerations, B–16
  - unsigned data items
    - size considerations, B–16
- Multiblock count
  - compiler implementation specifications, A–1
- Multiple delimiters
  - for unstringing data, 5–12
- MULTIPLE FILE TAPE clause
  - number of files
    - compiler implementation specifications, A–3
- Multiple operands
  - in ADD and SUBTRACT statements, 2–15
- Multiple receiving items
  - for unstringing data, 5–6

- Multiple run units, 12–1
- Multiple sending items
  - for stringing data, 5–1
- Multiple source files, compiling on OpenVMS
  - Alpha, 1–23, 1–24, 1–51
- Multiple source files, compiling on Tru64 UNIX, 1–9

## N

---

- NAMCLASS error
  - difference in HP COBOL for OpenVMS VAX and HP COBOL on Alpha behavior, B–19
- /NAMES, 1–27
- Names, conflicting, B–19
- names as\_is flag, 1–6
- names lower or -names lowercase flag, 1–6
- names upper or -names uppercase flag, 1–6
- /NATIONALITY, 1–27
- NATIVE option, 1–25
- Nested IF statements
  - static nesting depth
    - compiler implementation limitations, A–3
- Nested program
  - See Contained program
- Nesting
  - CALL statements, 12–6
- nm command, 1–19
  - use in locating undefined symbols, 1–13
- /NOALIGNMENT
  - syntax of, 16–5
- /NOALIGNMENT qualifier
  - default, 16–5
- NO ECHO phrase, 11–15
- nolocking flag, 1–6
- Non-COBOL programs
  - including in run unit, 12–26
- Nonnumeric data, 3–1 to 3–12
  - classes, 3–4
  - common nonnumeric item move errors, 3–11
  - concatenating items, 5–1
  - data movement, 3–6
    - two MOVE statements (ex.), 3–6
  - data organization, 3–2
  - edited moves, 3–9
    - with JUSTIFIED clause (tab.), 3–9
    - with symbols (tab.), 3–9
  - edited moves (tab.), 3–9
  - elementary moves, 3–7
  - elementary moves (tab.), 3–7
  - group items, 3–2
  - group moves, 3–7
  - justified moves, 3–9
  - MOVE CORRESPONDING statement, 3–11
  - MOVE CORRESPONDING statement (ex.), 3–11
  - MOVE statement, 3–7

- Nonnumeric data (cont'd)
  - multiple receiving items, 3-10
  - special characters, 3-3
  - storing, 3-1
  - STRING statement, 5-1
  - subscripted moves, 2-9, 3-10
  - testing, 3-3
    - class tests, 3-5
    - comparing operands, 3-5
    - relational operator descriptions, 3-3
    - relational operators (tab.), 3-3
  - using reference modification, 3-12
- Nonnumeric data items
  - elementary, 3-2
  - testing
    - relational tests, 3-3
- Nonnumeric literals
  - compiler implementation specifications, A-2
- non\_shared flag, 1-6, 1-14
- noobject flag, 1-6
- /NOOPTIMIZE, 1-48
- /NOVFC, 6-8
- nowarn flag, 1-6
- no\_archive flag (ld)
  - and creating shared libraries, 1-15
- Numeric class tests, 2-4
- Numeric data, 2-1 to 2-16
  - arithmetic statements, 2-9
    - common errors, 2-15
    - GIVING phrase, 2-14
    - intermediate rules, 2-9
    - multiple operands
      - ADD statement, 2-15
      - SUBTRACT statement, 2-15
    - multiple operands (tab.), 2-15
  - check decimal flag, 2-2
  - common numeric move errors, 2-9
  - convert leading\_blanks flag, 2-2
  - elementary numeric-edited moves, 2-7
  - elementary numeric moves, 2-6
  - evaluating numeric items, 2-3
  - invalid values, 2-2
  - MOVE statement, 2-6
  - NOT ON SIZE ERROR phrase, 2-14
  - /[NO]TRUNCATE qualifier, 2-13
  - numeric-edited data rules, 2-8
  - numeric-edited data rules (tab.), 2-8
  - numeric editing symbols, 2-7
  - ON SIZE ERROR phrase, 2-14
  - optimizing, 15-6
  - REMAINDER phrase, 2-13
  - representation of, 15-6
  - ROUNDED phrase, 2-13
  - rounding (ex.), 2-13
  - rounding (tab.), 2-13
  - sign conventions, 2-2
  - sign test (tab.), 2-4
  - storing, 2-1

- Numeric data (cont'd)
  - success/failure test (ex.), 2-5
  - testing
    - class test, 2-3, 2-4
    - relational operators description, 2-3
    - relational tests, 2-3
    - sign test, 2-3, 2-4
    - success/failure tests, 2-5
  - trunc flag, 2-13
- Numeric-edited data item, 2-6
  - contents, 2-7
  - description, 2-7
  - rules for, 2-8
- Numeric-edited moves
  - elementary, 2-7
- Numeric editing, 2-7
- Numeric items
  - invalid values in, 2-2
  - testing, 2-3
    - class test, 2-3
    - relation test, 2-3
    - sign test, 2-3
- Numeric moves
  - elementary, 2-6
- Numeric relational operators (tab.), 2-3

## O

---

- O0 flag, 1-6
- O1 flag, 1-7
- O2 flag, 1-7
- O3 flag, 1-7
- O4 or -O flag, 1-7
- /OBJECT, 1-27
  - in program development, 15-5
- Object file
  - directory used, 1-10
  - file name suffix, 1-3
  - linker order of loading, 1-13
  - linking, 1-20
  - obtaining information about, 1-19
  - passing directly to ld (example), 1-4
  - renaming, 1-10
  - retaining, 1-10
  - used to create a shared library, 1-14
- Object module
  - creating, 1-10, 1-22
  - default user libraries, 1-35
  - defining the search order for, 1-36
  - libraries
    - definition, 1-35
    - using system-supplied libraries, 1-36
    - using user-created libraries, 1-35
- OCCURS clause
  - indexes, 4-1
  - keys, 4-1

- OCCURS *n* TIMES clause
  - value of *n*
    - compiler implementation specifications, A-3
- odump command, 1-19
- .o file suffix, 1-10
- o flag, 1-10
- O flag, 15-1
  - and debugging, 15-5
- OMITTED argument-passing mechanism, 12-12
- ON EXCEPTION, B-16
- ON EXCEPTION phrase, 11-13
- o output flag, 1-7
- OPEN and CLOSE statements, 6-25
- Open mode
  - EXTEND, 6-25
  - INPUT, 6-25
  - I-O, 6-25
  - OUTPUT, 6-25
- OpenVMS
  - Run-Time Library routines, 13-4
  - System Services routines, 13-4
  - usages, 13-8
  - Usages
    - COBOL equivalents, 13-8
- OpenVMS Alpha
  - Calling Standard, 13-2
- OpenVMS Alpha tuning, 1-49
- Optimization, 15-1 to 15-25
  - confusing behavior in debugging, 15-5
  - DISPLAY, avoiding, 15-6
  - file design, 15-15
  - I/O operations, 15-10
    - APPLY clause, 15-11
      - DEFERRED-WRITE phrase, 15-12
      - EXTENSION phrase, 15-12
      - FILL-SIZE ON phrase, 15-12
      - PREALLOCATION phrase, 15-11
      - WINDOW phrase, 15-13
    - sharing record areas, 15-13
    - sharing record areas (fig.), 15-13
    - using multiple buffers, 15-13
  - image activation, 15-25
  - indexed files, 15-19
    - I/O, 15-20
      - alternate keys, 15-21
      - bucket size, 15-21
      - bucket size in bytes (tab.), 15-21
      - caching index roots, 15-25
      - calculating bucket size (tab.), 15-21
      - calculating index levels, 15-24
      - file size, 15-22
      - index depth, 15-22
      - records, 15-20
    - two-level primary index (fig.), 15-19
  - in relation to program structure, B-10
  - levels, 15-4
  - numeric data representation, 15-7

- Optimization
  - numeric data representation (cont'd)
    - BINARY, 15-6, 15-7
    - COMP, 15-6, 15-7
    - COMP-3, 15-7
    - DISPLAY, 15-7
    - mixing data types, 15-7
    - PACKED-DECIMAL, 15-7
    - scaling, 15-7
  - PROCEDURE DIVISION
    - indexing, 15-9
    - SEARCH, 15-9
    - SEARCH ALL, 15-9
    - subscripting, 15-9
  - relative files, 15-16
    - bucket size, 15-17
      - one block (tab.), 15-18
      - three blocks (tab.), 15-17
    - cell size, 15-16
      - calculating formulas (tab.), 15-16
    - file size, 15-18
    - maximum record number, 15-16
  - selection of data types, 15-8
  - sequential files, 15-15
- /OPTIMIZE, 1-27
  - and /DEBUG, 15-5
  - in programs, B-10
- /OPTIMIZE=TUNE, 15-2
- /OPTIMIZE qualifier, 15-1
- Oracle CDD/Repository, 15-7, C-15 to C-21
  - accessing data definitions, C-16
  - creating relationships, C-18
  - pathname specification
    - number of characters, A-2
  - records
    - including in source listing, C-15
  - using, C-15
  - with RECORD statement, C-18
- Other languages
  - calling from, 12-20
- Output files
  - created by cobol, 1-10
  - displaying, B-15
  - formatting, B-15
- Output listing, 1-11
- OUTPUT phrase, 9-11

## P

---

- p0 flag, 1-7
- p1 or -p flag, 1-7
- Padding, 16-4
- Page
  - advancing and line skipping
    - report (ex.), 10-9
  - logical, 10-5
  - physical, 10-5
  - size definition, 10-9

Page body, 10–13  
 Page footing, 10–4  
 Page heading, 10–3  
 PCA product, 15–7  
 Performance
 

- and data type selection, 15–8
- and intermediate data items, 15–8
- compilation, 1–47
- natural alignment for, 16–4
- run-time, 15–1

**PERFORM *n* TIMES**

- value of *n*
  - compiler implementation specifications, A–3

 Physical block size
 

- compiler implementation specifications, A–1

 Physical memory
 

- and compile performance, 1–50

 Physical page
 

- definition, 10–5

**PICTURE** character-strings
 

- alphanumeric or alphabetic
  - compiler implementation specifications, A–2
- alphanumeric or numeric edited
  - compiler implementation specifications, A–2
- compiler implementation specifications, A–2

**PICTURE** clause
 

- editing symbols, 2–7
- for intermediate data items, 15–8

 pixie, 15–7  
 Portability, D–1
 

- See also Compatibility
- Porting assistance, D–1

 Porting assistance, D–1  
 Precision
 

- and floating-point numbers, 15–6
- and USAGE COMP, 15–6
- not reduced by conversion to COMP, 15–6

 Primary key
 

- definition, 6–7
- segmented, 6–34

 Print-control file, 6–9, 6–28
 

- See also Variable with fixed-control records

 Procedure calls, 13–13  
 Procedures, 13–1  
 Productivity tools, C–1  
 prof, 15–7  
 Program
 

- accessing another data division, 12–10
- compiling, 1–3
- compiling, multiple files on OpenVMS Alpha, 1–24, 1–51
- compiling, multiple files on Tru64 UNIX, 1–9
- compiling multiple files on OpenVMS Alpha, 1–23

Program (cont'd)
 

- compiling on OpenVMS Alpha, 1–22
- contained, 12–1
- creating, 1–20
- driver, 12–1
- running, 1–9

 Program conversion
 

- using the /STANDARD=OPENVMS\_AXP
  - qualifier option, B–9

 Program development, 1–18  
 Program listing files, 1–31
 

- separate compilation, B–14

 Program listings
 

- See Compiler listing files

 Program run errors
 

- data errors, 1–52
- logic errors, 1–54

 Program run messages, 1–52  
 Program structure differences, B–9
 

- HP COBOL (ex.), B–9
- HP COBOL for OpenVMS VAX, B–9
- using the /OPTIMIZE qualifier, B–10

 Program switches
 

- See Switches

**PROTECTED** phrase, 11–13  
 Protecting records
 

- automatic record locking, 8–17, 8–19
- bypassing a record lock, 8–23
- concepts, 8–1
- error conditions, 8–23
  - hard record locks, 8–24
  - soft record locks, 8–24
  - soft record locks and Declarative USE
    - procedures, 8–25
  - manual record locking, 8–20
  - using record locking, 8–17

 Pseudocode placeholders
 

- unsupported by HP COBOL, B–4

## Q

---

**Qualifiers**

- COBOL command, 1–24 to 1–29
- with the COBOL command, 1–22

**QUIT** command (LSE), C–13

## R

---

-rsv, D–1  
 -rsv foreign\_extensions flag, D–1  
 Random access mode
 

- specifying, 6–21

 ranlib command, 1–19  
 Reading files
 

- line sequential, 6–37
- sequential, 6–37

READ NEXT statement  
   changing access mode, 6-44  
 READ PRIOR statement, 6-45  
 Record  
   See also File  
   blocking, specifying, 6-21  
   cells, 6-6  
   definition, 6-2  
   fixed-length, 6-9  
   format, 6-8  
   locking  
     Refer to Protecting records, Record locking,  
     and File sharing  
   processing, 6-1 to 6-61  
   protection  
     See Protecting records  
   space needs on a physical device, 6-8  
   variable-length, 6-10  
   variable with fixed-control, 6-12  
 Record access mode  
   definition, 6-23  
 RECORD CONTAINS clause, 6-8  
 Record definitions  
   compiler implementation specifications, A-1  
 Record description, 6-8, 6-9  
 Record format  
   specifying, 6-8  
 Record-length descriptions, multiple, 6-11  
 Record locking  
   See also Protecting records  
   definition, 8-2  
   HP standard, 8-3  
   successful, 8-17  
   X/Open standard, 8-3  
 Record Management Services (RMS), 1-56 to  
   1-59  
   See also RMS special registers  
   completion codes, 7-5  
 Record numbers  
   cell numbers, 6-6  
 RECORD statement, C-18  
 Record structures  
   alignment of, 16-3  
 RECORD VARYING clause, 6-8  
 REDEFINES clause  
   and numeric data storage, 2-1, 2-2  
 Redefinition  
   implied when inspecting data, 5-18  
 Reference  
   unresolved (linker), 1-16  
 REFERENCE argument-passing mechanism,  
   12-11  
 Reference format  
   terminal, 1-52  
 Reference modification, 3-12  
 Reference modification out of range, B-8  
 REFORMAT  
   purpose of, 1-52  
 REFORMAT utility, 14-1  
   converting reference format, 1-52  
   error messages, 14-4  
   running, 14-1  
 REGARDLESS, 8-3  
 Register usage, 13-2  
 Relation tests  
   description, 2-3  
   nonnumeric data, 3-3  
 Relative file  
   See also Optimization  
   access modes, 6-31  
   AT END condition, 7-1  
   capabilities, 6-5  
   creating, 6-29  
     random access mode, 6-30, 6-31  
     sequential access mode, 6-30  
   deleting records, 6-54  
     randomly, 6-56  
     sequentially, 6-54, 6-55  
     using the DELETE statement, 6-54  
   design considerations, 6-13  
   invalid key condition, 7-2  
   INVALID KEY condition, 7-2  
   open modes, 6-31  
   organization, 6-5, 6-6  
     advantages, 6-3  
     disadvantages, 6-3  
     specifying, 6-21  
   processing, 6-6, 6-31  
   reading, 6-38  
     dynamically, 6-40, 6-41  
     randomly, 6-39, 6-40  
     sequentially, 6-38, 6-39  
   record cells, 6-6  
   record numbers, 6-6  
   rewriting records  
     randomly, 6-53, 6-54  
     sequentially, 6-52, 6-53  
   rewriting records in, 6-51  
   SELECT statements, 6-24  
   specifying file organization and access mode,  
   6-22  
   tables, similarity to, 6-6  
   updating, 6-51  
     using the REWRITE statement, 6-51  
   usage, 6-5, 6-6  
   valid I/O statements (tab.), 6-31  
   writing, 6-32  
 Relative indexing, 4-15  
   system overhead, 4-15  
 Relative key  
   definition, 6-5

- Relative record number, 6–6
- relax\_key\_checking, 6–7
- relax\_key\_checking or -rkc flag, 1–7
- REMAINDER phrase, 2–13
- Replacement argument, 5–31
  - list
    - interference in, 5–32
    - to inspect data, 5–31
- Replacement value, 5–31
- REPLACE statement
  - differences, B–13
    - HP COBOL for OpenVMS VAX, B–13
    - HP COBOL for OpenVMS VAX (ex.), B–13
    - HP COBOL on OpenVMS Alpha, B–13
    - HP COBOL on OpenVMS Alpha (ex.), B–13
  - line numbers
    - HP COBOL for OpenVMS VAX (ex.), B–13
    - HP COBOL on OpenVMS Alpha (ex.), B–13
  - line numbers in compiler listing files, B–13
  - listing multiple instances of source line, B–13
- REPLACING phrase
  - to inspect data, 5–30
- Report
  - bolding items in, 10–89
  - bottom margin, 10–13
  - components of, 10–1
  - components of (ex.), 10–1
  - control footing, 10–4
  - control heading, 10–3
  - conventional, 10–6
    - See also Conventional Report
  - controlling spacing, 10–7
  - line counter usage, 10–8
  - logical page, 10–6
  - logical page area (fig.), 10–6
  - page-overflow condition, 10–7
  - page-overflow condition (ex.), 10–8
  - printing, 10–9
  - design, 10–1
  - detail lines, 10–4
  - footing, 10–4
  - footing area, 10–13
  - GROUP INDICATE clause, 10–36
  - heading, 10–3
  - layout worksheet (fig.), 10–1
  - linage-file report, 10–12
    - See also Linage-file
    - controlling spacing, 10–14
    - page advancing, 10–14
    - page overflow, 10–15
    - page overflow (ex.), 10–15
    - printing, 10–19
    - using the LINAGE-COUNTER, 10–14
  - linage-file report (ex.), 10–20
- Report (cont'd)
  - logical page, 10–5, 10–13
  - makeup, 10–6
  - modes of printing, 10–23
  - page advancing and line skipping (ex.), 10–9
  - page body, 10–13
  - page footing, 10–4
  - page heading, 10–3
  - physical page, 10–5
  - printing, 10–8
  - printing totals before detail lines, 10–88
  - problem solving, 10–82
    - bolding items, 10–89
    - example, 10–82, 10–84
    - GROUP INDICATE clause, 10–87
    - logical lines, 10–82
    - physical lines, 10–82
    - physical page, 10–88
    - printing, 10–82, 10–88
      - bold, 10–89
      - details, 10–88
      - totals, 10–88
    - underlining, 10–89
  - RESET phrase, 10–35
  - spooling, 10–23
  - streamlining your, 10–88
  - top margin, 10–13
  - total accumulating, 10–4
    - crossfooting, 10–34
    - crossfoot totals, 10–4
    - defining, 10–33
    - incrementing, 10–33
    - RESET phrase, 10–35
    - rolled forward totals, 10–4
    - rolling-forward, 10–34
    - subtotals, 10–4, 10–33
    - UPON phrase, 10–35
  - total accumulating (fig.), 10–4
  - underlining in, 10–89
  - UPON phrase, 10–35
  - USE BEFORE REPORTING statement, 10–40
- Report file
  - number of lines
    - compiler implementation specifications, A–3
- Report groups
  - sample report using all seven (fig.), 10–26
- Report Writer
  - assigning a value in a print line, 10–30
  - assigning the source for a print field, 10–30
  - COLUMN NUMBER clause, 10–29
  - CONTROL clause, 10–31
  - detail reporting, 10–41
  - examples, 10–42
    - detail report, 10–43, 10–48, 10–56, 10–64
    - input data, 10–42
    - summary report, 10–73
  - first GENERATE statement (fig.), 10–38

## Report Writer (cont'd)

- footings
  - controlling, 10–31
  - generating, 10–31
- GENERATE statement, 10–38
- headings
  - controlling, 10–31
  - generating, 10–31
- INITIATE statement, 10–37
- LINE clause, 10–28
- logical page
  - defining, 10–25
  - horizontal spacing, 10–29
  - vertical spacing, 10–28
- PAGE clause, 10–25
- printing
  - GROUP INDICATE clause, 10–36
- processing a Report Writer report, 10–37
  - detail reporting, 10–41
  - GENERATE statement, 10–38
  - initiating, 10–37
  - suppressing a report group, 10–41
  - terminating processing, 10–39
  - USE BEFORE REPORTING statement, 10–40
- Programming, 10–24
- REPORT clause, 10–24
- Report Description entry, 10–24
- Report File
  - defining, 10–24
- report groups, 10–25
- report group types (tab.), 10–25
- Report Section
  - defining, 10–24
- SOURCE clause, 10–30
- specifying multiple reports, 10–31
- subsequent GENERATE statements (fig.), 10–39
- SUPPRESS statement, 10–41
- TERMINATE statement, 10–39
- TERMINATE statement (fig.), 10–40
- using Declarative procedures, 10–40, 10–41
- VALUE clause, 10–30

RESERVE AREAS clause

- value of integers
  - compiler implementation specifications, A–1

Reserved words, D–2

- compatibility with HP COBOL for OpenVMS VAX, B–28

/RESERVED\_WORDS, 1–28

/RESERVED\_WORDS qualifier, D–1

- HP COBOL support for, B–4

Restrictions on interprogram communication, 12–31

RETURN-CODE, 12–13

RISC architecture, 1–47

RMS completion codes, using, 7–3

RMS special registers, 1–56 to 1–59

- differences, B–21, B–26
- list of, 1–56
- RMS-CURRENT-FILENAME, 1–56, 7–6
- RMS-CURRENT-STS, 1–56, 7–6
- RMS-CURRENT-STV, 1–56, 7–6
- RMS-FILENAME, 1–56 to 1–59, 7–6
- RMS-STS, 1–56 to 1–59, 7–6, 8–12 to 8–15
- RMS-STV, 1–56 to 1–59, 7–6
- RMS\_CURRENT\_STS, B–21
- RMS\_CURRENT\_STV, B–21
- RMS\_STS, B–21

ROUNDED phrase, 2–13

- with SIZE ERROR, 2–14

Rounding off arithmetic results, 2–13

Routines, 13–1

- Named “main”, 1–3

-rsv [no]200x flag, 1–7

-rsv [no]foreign\_extensions, 1–7

-rsv [no]xopen flag, 1–7

RUN command, 1–43

- on OpenVMS Alpha, 1–43
- syntax, on OpenVMS Alpha, 1–46

Running HP COBOL programs

- on OpenVMS Alpha, 1–43
- on Tru64 UNIX, 1–16

Run time

- accessing environment variables, 1–17
- accessing environment variables (ex.), 1–17
- accessing logicals, 1–44
- errors, 1–47
  - example of, 1–47
- input/output messages, 1–55
- messages, 1–46
  - format, 1–46
  - input/output errors, 1–55
  - interpreting, 1–47
  - program run errors, 1–52

Run-Time Library routines, 13–4

- cobcall, 12–20
- cobcancel, 12–20
- cobfunc, 12–20

Run-time storage

- compiler implementation specifications, A–1

Run unit

- examples of COBOL, 12–1 to 12–2
- including non-COBOL programs, 12–26
- multiple COBOL program, 12–1

## S

Scaling

- and mixing data types, 15–7
- definition, 15–7



SCA product, 15–7, C–12  
 integration with LSE, C–12  
 invoking, C–14  
 preparing an SCA library, C–13

Screen formatting, B–16

Screen positioning  
 absolute, 11–5  
 relative, 11–5

Screen Section, 11–31  
 options, 11–32

SD record length  
 compiler implementation specifications, A–1

SEARCH ALL  
 support for EBCDIC collating sequence, 15–10

SEARCH ALL statement  
 advantages, 15–10  
 requirements, 15–10

Search argument  
 usage in REPLACING phrase, 5–30

Searching tables, 4–16

Search order  
 definition for object module libraries, 1–36

SEARCH statement  
 Format 1, 4–17  
 Format 2, 4–18

Segmented key, 6–34  
 example, 6–35

SELECT statement  
 file description, 6–14  
 specifying file organization with, 6–20

Separately compiled programs, 1–24

/SEPARATE\_COMPILATION, 1–24, 1–28  
 and program listings, B–14  
 compilation performance, 1–51

-seq flag, 1–7

/SEQUENCE\_CHECK, 1–28

-sequence\_check flag, 1–7

Sequential access mode  
 default, 6–23  
 specifying, 6–21

Sequential file  
 See also Optimization  
 access modes, 6–28  
 AT END condition, 7–1  
 creating, 6–26, 6–27  
 design considerations, 6–13  
 end-of-file mark, 6–4  
 end-of-volume label, 6–4  
 extending, 6–28, 6–51  
 using the EXTEND phrase, 6–51  
 I/O statements, 6–28  
 multiple-volume (fig.), 6–4  
 multiple volumes, 6–4  
 open modes, 6–28  
 organization  
 specifying, 6–21  
 organization of, 6–3  
 advantages, 6–2

Sequential file  
 organization of (cont'd)  
 disadvantages, 6–2  
 print file, 6–28  
 processing, 6–27  
 reading, 6–37, 6–38  
 rewriting a, 6–50  
 rewriting records in, 6–49  
 SELECT statements, 6–24  
 specifying file organization and access mode,  
 6–21  
 storage file, 6–28  
 updating, 6–49  
 using the REWRITE statement, 6–49  
 valid I/O statements (tab.), 6–28  
 writing, 6–28  
 writing records from, 6–29

Sequential file organization (fig.), 6–3

Sequential search, 4–16 to 4–18  
 See also SEARCH statement  
 function of AT END statement, 4–17  
 requirements for, 4–17

SET ALIGNMENT directive  
 syntax of, 16–6

setenv command, 1–61

SET NOALIGNMENT directive  
 syntax of, 16–6

SET NOPADALIGN directive, 16–6

SET NOVOLATILE directive  
 syntax of, 16–3

SET PADALIGN directive, 16–6

SET statement  
 example, 1–60  
 Format 1, 4–16  
 Format 2, 4–16  
 indexing function, 4–16  
 switches, 1–60

SET VOLATILE directive  
 syntax of, 16–3

/SHARE, 1–37 to 1–39

Shareable image  
 calling, 12–32  
 differences, B–22  
 creating, 1–37  
 definition, 1–37  
 using in linking, 1–37  
 using symbol vectors, 1–39

Shareable images, 1–42  
 transfer vectors, 1–41

Shareable objects  
 calling, 12–32

Shared command-line qualifiers, B–4  
 (tab.), B–4

-shared flag, 1–7

-shared flag (ld)  
 creating shared libraries, 1–14

- Shared library
  - creating, 1-14 to 1-15
    - required flags, 1-14
    - restrictions, 1-15
    - using cobol, 1-14
    - using cobol and ld, 1-14
  - file name suffix, 1-3
  - flags for creating, 1-14
  - installing, 1-15
  - obtaining information about, 1-19
  - requirements for symbol reference, 1-15
  - restrictions creating, 1-15
  - specifying using COBOL, 1-12
- /SHARE qualifier, 1-37 to 1-41
- Sharing
  - source text, 1-21
  - USE procedures, 12-17
- show code flag, 1-7
- show copy flag, 1-7
- show xref flag, 1-7
- Sign
  - conventions, 2-2
  - tests
    - description of, 2-4
    - unsigned item and absolute value, 2-2
    - unsigned items, avoiding in arithmetic (ex.), 2-2
- SIGN clause, 2-2
- Significant digits, limiting, 15-8
- Size
  - fixed-length tables, 4-1
  - variable-length tables, 4-6
- size command, 1-19
- SIZE ERROR phrase, 2-14
- SIZE phrase, 11-15
- Sneakernet, 6-4
- SORT-32, 9-9, A-3
- Sorting data
  - SORT statement, 9-1
- Sorting records
  - concepts, 9-2
  - multiple sort keys, 9-2
  - single sort key, 9-2
- Sort key
  - definition, 9-2
  - major, 9-3
  - minor, 9-3
- Sort parameters
  - order of, 9-3
- SORT statement, 9-1 to 9-10
  - ASCENDING KEY phrase, 9-3
  - COLLATING SEQUENCE phrase, 9-7
  - DESCENDING KEY phrase, 9-3
  - example, 9-1
  - file description entry
    - example, 9-1
  - file organization, 9-2
  - GIVING phrase, 9-3
- SORT statement
  - GIVING phrase (cont'd)
    - with the INPUT PROCEDURE phrase, 9-5
  - INPUT PROCEDURE phrase, 9-3
    - example, 9-4
    - with the GIVING phrase, 9-5
  - multiple sorts, 9-7
    - example, 9-7
  - number of USING files
    - compiler implementation specifications, A-2
  - OUTPUT PROCEDURE phrase, 9-3
    - example, 9-4
    - with the USING phrase, 9-5
  - preventing I/O aborts, 9-9
    - Declarative USE AFTER STANDARD ERROR PROCEDURE, 9-9
  - sample programs, 9-10
  - SELECT statement
    - example, 9-1
  - sorting variable-length records, 9-8
  - USING phrase, 9-3
    - with the OUTPUT PROCEDURE phrase, 9-5
  - USING phrase replacing INPUT PROCEDURE phrase
    - example, 9-5
  - WITH DUPLICATES IN ORDER phrase, 9-6
    - example, 9-6
    - with tables, 9-9, 15-10
- /SOURCE, 1-28
- Source Code Analyzer
  - See SCA
- Source code listing, 1-11
- Source files
  - analyzing source code using Tru64 UNIX tools, 1-19
  - building using Tru64 UNIX tools, 1-19
  - creating and revising, 1-1
  - managing using Tru64 UNIX tools, 1-19
- Source form
  - and file name suffix, 1-2
- Source programs
  - creating, 1-21
  - linking, on Tru64 UNIX, 1-12
- Special characters
  - nonnumeric data, 3-3
- SPECIAL-NAMES
  - ACCEPT statement, 11-1
  - DISPLAY statement, 11-1
  - logical name, 11-1
  - paragraph, 3-5
- Special registers
  - and GLOBAL, 12-17, 12-19
  - LINE-COUNTER, 12-19
  - PAGE-COUNTER, 12-19
  - RETURN-CODE, 12-13

- Stack usage, 13–2
- /STANDARD, 1–28
  - HP COBOL support for, B–4
- /STANDARD=OPENVMS\_AXP qualifier option, B–9
  - default, B–9
- STANDARD option, 1–25
- Status
  - library return, 13–15
- std 85 flag, 1–7
- std flag, 1–7
- stdin, 11–2
- stdout, 11–2
- std v3 flag, 1–7
- std [no]mia flag, 1–7
- std [no]syntax flag, 1–7
- std [no]xopen flag, 1–7
- Storage allocation
  - byte boundaries, 4–7
  - effect of fill bytes, 4–7
  - table data, 4–6
  - tables containing COMP or COMP SYNC items, 4–7
- Storage differences
  - for double-precision data, B–20
- Storage file, 6–28
- Storage issues
  - based on architectural differences, B–20
- Storage of double-precision data
  - Alpha architecture
    - more information, B–20
- Storage space
  - minimizing, 2–1
- Storing nonnumeric data, 3–1
- Storing numeric data, 2–1
- Storing return values
  - Alpha architecture, B–18
  - VAX architecture, B–18
- Stream, 6–8, 6–12
  - and ORGANIZATION IS LINE SEQUENTIAL, 6–12
- STRING statement, 5–1 to 5–6
  - common STRING statement errors, 5–6
  - DELIMITED BY phrase, 5–2
    - matching characters (fig.), 5–18
  - multiple sending items, 5–1
    - literals (ex.), 5–2
  - NOT ON OVERFLOW statement, 5–5
  - overflow condition (ex.), 5–5
  - OVERFLOW statement, 5–4
    - results of (tab.), 5–5
  - POINTER phrase, 5–4
    - results of (fig.), 5–2
- strip command, 1–19, 12–32
- Subprogram
  - contained, 12–1
- Subscripted moves
  - nonnumeric data, 2–9, 3–10
- Subscripting
  - with data-names, 4–14
- Subscript name
  - subscript value
    - compiler implementation specifications, A–3
- Subscripts
  - definition, 4–12
  - number of levels
    - compiler implementation limitations, A–3
- Success/failure tests, 2–5
- Supplementary information on interprogram communication, 12–31
- SWITCH clause
  - value of switch numbers
    - compiler implementation specifications, A–1
- Switches
  - checking, 1–61, 1–62
  - controlling, 1–62
    - controlling externally, 1–62
    - controlling internally, 1–60
  - definition, 1–60
  - order of evaluation, 1–62
  - program, 1–60 to 1–63
  - SET statement, 1–60
  - setting externally, 1–61
  - setting for a process, 1–60
  - setting internally, 1–60
  - using, 1–60
- Symbol
  - library condition values, 13–15
  - numeric editing, 2–7
  - record, C–7
- SYMBOLIC CHARACTERS clause
  - value of numeric literals
    - compiler implementation specifications, A–1
- Symbol table
  - and /DEBUG, 1–46
  - definition, 1–35
- Symbol vectors
  - definition, 1–39
  - using with shareable images, 1–39
- SYNCHRONIZED clause
  - and alignment, 16–8
  - for data alignment, 15–5
- Syntax synonyms, D–1
- SYS\$SETSFM routine (ex.), 13–17
- System logical
  - accessing at run time, 1–44
- System messages
  - See Linker messages
  - compiler, 1–29
  - run-time

- System messages
  - run-time (cont'd)
    - See Run-time messages
- System return codes, differences, B-17
  - with illegal coding, B-17
- System routines, 13-1, 13-11
  - calling subroutine, 13-13
  - function calls, 13-11
  - function results, 13-15
- System services routines, 13-4
- System spooler, 10-9
- System-supplied object module libraries
  - definition, 1-36

## T

---

- Table elements
  - initializing, 4-10
- Tables
  - See also Storage allocation and Subscripts
  - accessing
    - literal subscripts (ex.), 4-13
    - with indexes, 4-12, 4-14
    - with literal subscripts, 4-13
    - with SEARCH statement, 4-16
    - with subscripts, 4-12
  - accessing table elements, 4-12
  - access methods, 4-12
  - assigning values using the SET statement, 4-16
    - integer value, 4-16
  - binary search, 4-18
    - multiple-key (ex.), 4-23
    - with keys, 4-18
    - with multiple keys, 4-19
  - defining
    - index and ascending search key (ex.), 4-3
    - sample record description (ex.), 4-7
    - variable-length (ex.), 4-6
  - defining fixed-length, 4-1
    - multidimensional, 4-4
  - defining variable-length tables, 4-5
    - ascending and descending keys, 4-5
    - size, 4-6
  - definition, 4-1
  - element length
    - adding bytes (ex.), 4-9
  - fixed-length
    - specifying size, 4-1
  - incrementing an index value using the SET statement, 4-16
  - index data item
    - where defined, 4-3
  - index data items, 4-16
  - initializing, 4-10
    - alphanumeric items (ex.), 4-11
    - effect of fill bytes, 4-12
    - INITIALIZE statement, 4-12

- Tables
  - initializing (cont'd)
    - mixed usage items (ex.), 4-11
    - OCCURS clause (ex.), 4-10
    - redefining group level, 4-11
    - VALUE clause (ex.), 4-10
    - with OCCURS clause, 4-10
    - with VALUE clause, 4-10
  - initializing indexes, 4-15
  - memory map
    - adding 3 bytes (fig.), 4-9
    - adding item (fig.), 4-8
    - COMP SYNC item (fig.), 4-8
    - defining (fig.), 4-7
    - initializing alphanumeric items (fig.), 4-12
    - initializing mixed usage items (fig.), 4-11
    - initializing with VALUE clause (fig.), 4-10
  - multidimensional
    - accessing with subscripts, 4-13
      - rules for (tab.), 4-14
    - defining, 4-4
    - OCCURS clause, 4-1
      - indexes, 4-1
      - keys, 4-1
    - subscripts (ex.), 4-13
  - one-dimensional, 4-1
    - multiple data items in (ex.), 4-2
    - organization of multiple data items (fig.), 4-2
  - one-dimensional (ex.), 4-2
  - one-dimensional organization of (fig.), 4-2
  - organization of
    - index and ascending search key (fig.), 4-4
  - relative indexing, 4-15
  - sample (ex.), 4-20
  - sequential search, 4-17
    - AT END statement, 4-17
  - serial search
    - without VARYING phrase (ex.), 4-23
  - serial search (ex.), 4-20
  - size
    - adding items (ex.), 4-8
  - storage allocation, 4-6
    - using the SYNCHRONIZED clause, 4-7
  - subscripting with data names, 4-14
  - subscripting with data names (tab.), 4-14
  - subscripts
    - index name items (ex.), 4-15
  - three-dimensional
    - organization of (fig.), 4-4
  - three-dimensional (ex.), 4-4
  - two-dimensional
    - organization of (fig.), 4-4
  - two-dimensional (ex.), 4-4
  - using SEARCH and varying index data item (ex.), 4-21
  - using SEARCH and varying index other than the first (ex.), 4-20

- Tables (cont'd)
  - using SEARCH and varying unrelated index (ex.), 4-22
- Table sort, 9-9, 15-10
- Tally argument
  - to inspect data, 5-24
- Tally counter
  - to inspect data, 5-24
- taso flag, 1-7
- Temporary files
  - created by cobol, 1-10
  - directory used by cobol, 1-10
  - TMPDIR environment variable used by cobol, 1-10
- Temporary work items
  - for arithmetic statements, 2-9
- Terminal format, 1-52
  - See Developing programs
  - advantages of, 1-52
  - definition, 1-52
- Terminal reference format, 1-52
- Terminal screen I/O, 11-1
- Terminal-to-ANSI
  - format conversion, 14-3
- Testing
  - nonnumeric data items, 3-3
  - numeric items, 2-3
    - relational tests, 2-3
- /TIE, 1-28
- /TIE qualifier
  - HP COBOL support for, B-4
- TMPDIR environment variable
  - use during compilation, 1-10
- T num flag, 1-7
- Tools, C-1
- Top margin, 10-13
- tps flag, 1-7, 1-8
- TRACEBACK facility, 1-47
- Tru64 UNIX commands
  - for program development, 1-1
- /TRUNCATE, 1-28
- Truncation of data, 2-13
  - justified moves, 3-9
  - nonnumeric moves, 3-9
  - /[NO]TRUNCATE qualifier, 2-13
  - preventing, 2-1
  - trunc flag, 2-13
- trunc flag, 1-7, 2-13
- tune, 15-2
- tune flag, 1-7

## U

- UNLOCK ALL, 8-3
- Unreachable code, B-9
- Unresolved references, 1-16
- Unstringing data, 5-6
- UNSTRING statement, 5-6 to 5-17
  - common errors, 5-16
  - COUNT phrase, 5-12, 5-14
  - DELIMITED BY phrase, 5-8
    - delimiting multiple receiving items
      - results of (tab.), 5-9
    - delimiting with all asterisks
      - results of (tab.), 5-11
    - delimiting with all double asterisks
      - results of (tab.), 5-11
    - delimiting with an asterisk
      - results of (tab.), 5-8
    - delimiting with two asterisks
      - results of (tab.), 5-10
    - multiple delimiters
      - results of (tab.), 5-12
  - DELIMITER phrase, 5-13
  - delimiters, 5-10, 5-11
  - function, 5-6
  - handling short sending items (tab.), 5-8
  - multiple delimiters, 5-12
  - multiple receiving items, 5-6, 5-9
    - based on sending item value (tab.), 5-7
  - OVERFLOW statement, 5-16
  - POINTER phrase, 5-14
  - TALLYING phrase, 5-15
- Updating files
  - line sequential, 6-49
  - sequential, 6-49
- Usages, 13-8
  - DISPLAY the default, 2-1
- USE AFTER STANDARD ERROR PROCEDURE
  - example, 9-9
- USE procedures with LINKAGE SECTION
  - references
    - effect on optimization, 15-10
- User-words
  - number of characters
    - compiler implementation specifications, A-2
- USE statement
  - purpose of, 12-17
  - Rule 2 example, 12-18
- USING and Giving phrases, 9-3
- USING and OUTPUT phrases, 9-11
- Using file protection, 8-4
- Using object module libraries
  - defining as the default, 1-35
  - system-supplied, 1-36
  - user-created, 1-35
- USING phrase, 9-3, 9-11
  - number of operands
    - compiler implementation specifications, A-2
  - replaces INPUT PROCEDURE phrase
    - example, 9-5
  - usage of, 12-11

- Using the /STANDARD=OPENVMS\_AXP qualifier
  - option
  - with HP COBOL for OpenVMS VAX programs, B-9
- Using the DEFINE command
  - default object module libraries, 1-35
- Using the MERGE statement
  - example, 9-10
- Using the USING and OUTPUT PROCEDURE phrases
  - example, 9-11
- Using two sort files
  - example, 9-7
- Utility
  - REFORMAT, 14-1

## V

---

- VALUE argument-passing mechanism, 12-12
- VALUE OF ID clause
  - file description, 6-17
  - maximum length of string, A-1
- Variable-length records, 6-10
  - creating
    - with DEPENDING ON phrase, 6-10
    - with OCCURS clause and DEPENDING ON phrase, 6-11
    - with RECORD VARYING phrase, 6-11
  - creation of, 6-10 to 6-12
  - sorting, 9-8
- Variable with fixed-control records, 6-12
- VAX architecture
  - register set differences, B-17
- VFC, 6-8
- /VFC, 1-28
- /VFC qualifier, B-15
- v flag, 1-7
- V flag, 1-7
  - example, 1-11
- Video forms, 11-1 to 11-40
  - accepting data, 11-13
    - ON EXCEPTION with CONVERSION, 11-13
  - ACCEPT statement, 11-4
    - CONTROL KEY IN phrase, 11-20
      - characters returned, 11-20
      - example, 11-24
    - DEFAULT phrase, 11-17
      - example, 11-18
    - EDITING phrase, 11-28
    - NO ECHO phrase, 11-15
    - options, 11-12
  - assigning character attributes, 11-8
  - assigning default values to data fields, 11-17
  - clearing the screen, 11-4
  - COLUMN NUMBER phrase, 11-5
    - PLUS option, 11-7
  - CONVERSION phrase, 11-9, 11-13

- Video forms
  - CONVERSION phrase (cont'd)
    - example, 11-9
  - defining keys, 11-20
  - designing, 11-4
  - displaying data, 11-9
  - DISPLAY statement, 11-4
  - editing, 11-28
  - ERASE phrase, 11-4
    - options, 11-4
  - input, object of, 11-1
  - LINE NUMBER phrase, 11-5
    - PLUS option, 11-7
  - output, object of, 11-1
  - positioning the cursor
    - absolute, 11-5
    - relative, 11-5
  - PROTECTED phrase, 11-13
  - protecting the screen, 11-13
  - Screen Section, 11-31
  - supported terminals, 11-3
- Virtual memory
  - and compile performance, 1-49
- VOLATILE directive, 16-3
  - changing with directives, 16-3
  - syntax of, 16-3

## W

---

- warn all flag, 1-7
- warn flag, 1-7
- /WARNINGS, 1-28
  - in compiler listing files, 1-32
- warn none flag, 1-7
- warn [no]information flag, 1-7
- warn [no]other flag, 1-7
- w flag, 1-7
- WINDOW option
  - value of integers
    - compiler implementation specifications, A-1
- WRITE AFTER ADVANCING, 6-12
- WRITE statement
  - with LINAGE, B-16
- Writing files
  - line sequential, 6-29
- Writing programs
  - compatibility and portability with HP COBOL for OpenVMS VAX, B-1

## X

---

- X/Open standard file sharing, 8-3
- X/Open standard record locking, 8-3
- XOPEN option, 1-28
- 200X option, 1-28

-xref flag, 1-7  
-xref\_stdout flag, 1-7

## Y

---

Year 2000  
date change problem, 1-63

