

HP Reliable Transaction Router

System Manager's Manual

Order Number: BA416-90003

March 2007

This manual describes how to configure, manage, and monitor HP Reliable Transaction Router.

Revision/Update Information: This manual supersedes the *Reliable Transaction Router System Manager's Manual*, Version 5.0.

Software Version: HP Reliable Transaction Router Version 5.1

Hewlett-Packard Company
Palo Alto, California

© Copyright 2007 Hewlett-Packard Development Company, L.P.

Confidential computer software. Valid license from HP required for possession, use or copying. Consistent with FAR 12.211 and 12.212, Commercial Computer Software, Computer Software Documentation, and Technical Data for Commercial Items are licensed to the U.S. Government under vendor's standard commercial license.

The information contained herein is subject to change without notice. The only warranties for HP products and services are set forth in the express warranty statements accompanying such products and services. Nothing herein should be construed as constituting an additional warranty. HP shall not be liable for technical or editorial errors or omissions contained herein.

Microsoft and Windows are U.S. registered trademarks of Microsoft Corporation.

Intel and Itanium are trademarks or registered trademarks of Intel Corporation or its subsidiaries in the United States and other countries.

UNIX is a registered trademark of The Open Group. Java is a US trademark of Sun Microsystems, Inc.

This document was prepared using DECdocument, Version 3.3-1B.

Contents

Preface	xvii
1 Introduction	
1.1 Initial Setup	1-1
1.2 Administering RTR and RTR Applications	1-2
1.3 RTR Administrator	1-3
1.3.1 RTR Manager	1-10
1.3.2 RTR Explorer	1-11
1.3.2.1 RTR Explorer Icons	1-13
1.3.2.2 RTR Explorer Help	1-18
1.4 Command Line Interface (CLI)	1-21
1.4.1 Online Help for the RTR CLI	1-22
1.5 Command Procedures	1-23
1.6 Remote Commands	1-24
2 Starting and Setting Up RTR	
2.1 Introduction	2-1
2.2 Setting Up—An Example	2-2
2.2.1 Starting RTR and Creating a Facility	2-3
2.3 Creating a Recovery Journal	2-5
2.3.1 Maximum Journal Size	2-7
2.4 Fast Shadow Recovery Journaling	2-7
2.5 Changing Membership of a Facility	2-7
2.6 Setting Up Callout Servers	2-12
2.7 Router Considerations	2-13
2.8 Router Load Balancing	2-14
2.9 Concurrent Processes	2-16
2.10 RTR Privileges	2-17
2.11 RTRACP Virtual Memory Sizing for all Systems	2-18
2.11.1 OpenVMS Virtual Memory Sizing	2-20
2.11.2 UNIX Virtual Memory Sizing	2-22

2.12	RTR Shared Memory Sizing	2-23
2.13	Environment Variables Used by RTR	2-23
2.13.1	Environmental Variables for HP-UX and Linux I64 Clusters	2-24
2.13.2	Tuning for Journal Access in a Cluster	2-24
2.13.3	Compression of Event and Reply Data	2-26
2.13.4	Flow Control Environment Variables	2-27
2.13.5	Sizing for Channels and Sockets	2-28
2.13.6	Optional TID Values	2-29
2.13.7	Environment Variable Descriptions	2-29
2.14	Network Transports	2-35
2.14.1	Specifying the Link Transport Protocol	2-36
2.14.2	Using RTR with DHCP and Internet Tunnels	2-36
2.14.3	Network Protocol Selection	2-38
2.14.4	Dual-Rail Setup	2-39
2.14.5	DNS Server Support	2-42
2.14.6	Tunnel Configurations	2-43
2.15	Running RTR as a Service on Windows	2-43
2.15.1	Customizing the RTR Windows Service	2-44
2.15.2	Files Created by the RTR Windows Service	2-45
2.16	Assignment of Processing States for Partitions	2-45
2.16.1	Sequence Numbers in a Shadow Configuration	2-48
2.16.2	Setting Failover Policy	2-49
2.17	Router Selection in Facilities	2-50
2.18	Clustering Considerations for RTR Standby Servers	2-50
2.18.1	OpenVMS Clusters and Tru64 Truclusters	2-52
2.18.1.1	Journal Location	2-52
2.18.1.2	Journal Locking	2-52
2.18.1.3	Cluster Communications on OpenVMS and Tru64	2-53
2.18.2	HP-UX and Linux Clusters	2-53
2.18.2.1	Journal Location	2-53
2.18.2.2	Journal Locking	2-54
2.18.3	Windows Clusters	2-54
2.18.3.1	Journal Location	2-54
2.18.3.2	Facility Role Definition	2-55
2.18.3.3	RTR Home Directory	2-55
2.18.3.4	Cluster Failover	2-55
2.18.4	Unrecognized Clusters	2-55

3 Partition Management

3.1	Overview	3-1
3.1.1	What is a Partition?	3-1
3.2	Partition Naming	3-2
3.2.1	Name Format and Scope	3-2
3.2.2	Default Partition Names	3-2
3.2.3	Programmer-Supplied Names	3-2
3.2.4	System-Manager Supplied Partition Names	3-2
3.3	Life Cycle of a Partition	3-3
3.3.1	Implicit Partition Creation	3-3
3.3.2	Explicit Partition Creation	3-3
3.3.3	Persistence of Partition Definitions	3-3
3.4	Binding Server Channels to Named Partitions	3-4
3.5	Entering Partition Commands	3-4
3.5.1	Command Line Usage	3-5
3.5.2	Programmed Partition Management	3-5
3.6	Managing Partitions	3-6
3.6.1	Controlling Shadowing	3-6
3.6.2	Controlling Transaction Presentation	3-7
3.6.3	Controlling Recovery	3-8
3.6.4	Controlling the Active Site	3-9
3.6.5	Controlling Failover	3-9
3.6.6	Controlling Transaction Replay	3-11
3.6.7	Partition Persistence	3-12
3.7	Displaying Partition Information	3-12

4 Transaction Management

4.1	Overview	4-1
4.2	Exception Transactions	4-3
4.2.1	Dealing with EXCEPTION Transactions	4-4
4.2.2	What EXCEPTION Transactions Mean to Data Integrity	4-4
4.3	Transaction State Changes	4-4
4.4	Command Line Examples	4-7

5 Server Shadowing and Recovery

5.1	Primary and Secondary Partition States	5-1
5.2	Automatic Features	5-5
5.2.1	Shadow Events in Partitions	5-5
5.3	RTR Journal System	5-6
5.4	Shadow Site Failure and Journaling	5-6
5.5	Performance	5-7
5.6	Shadows in Action	5-7
5.7	Server States	5-8
5.8	Client States	5-11
5.9	Partition States	5-11

6 Performance Management

6.1	Performance Counter Hosting	6-2
6.2	Terminology	6-3
6.2.1	Counter Host	6-3
6.2.2	Target Machines	6-3
6.3	Starting and Stopping Performance Counter Hosting	6-3
6.4	Using Windows Performance Counters	6-4
6.5	Ensuring your Data Are Valid	6-5
6.5.1	Counter Host Unknown	6-5
6.5.2	Stale Performance Data	6-6
6.5.3	Mismatched Sampling and Display Rates	6-6
6.5.4	Invalid Instance Names	6-6
6.6	Removing RTR Counters from the Registry	6-6

7 Troubleshooting RTR Applications

7.1	RTR Monitor Pictures	7-1
7.2	Troubleshooting a Looping RTRACP Process	7-2
7.3	Enabling RTR Logging	7-3
7.4	Starting a Facility	7-3
7.5	Analyzing RTR Application Performance	7-4
7.6	Server Crashes	7-6
7.7	Link-Connect Failures	7-7
7.8	Rejected Transactions	7-8
7.9	Preparing to Submit a Problem Report	7-8
7.9.1	Using the Snapshot Procedure	7-9
7.9.2	Generating a Process Dump	7-10
7.9.3	Accessing the RTR Error Log	7-11

8 RTR Monitoring

8.1	Introduction	8-1
8.2	Standard Monitor Pictures	8-2
8.2.1	Monitor Accfail	8-6
8.2.2	Monitor Acp2app	8-7
8.2.3	Monitor Active	8-8
8.2.4	Monitor Alarm	8-9
8.2.5	Monitor App2acp	8-9
8.2.6	Monitor Appdelay	8-10
8.2.7	Monitor Broadcast	8-10
8.2.8	Monitor Calls	8-11
8.2.9	Monitor Channel	8-12
8.2.10	Monitor Compress	8-12
8.2.11	Monitor Connects	8-14
8.2.12	Monitor Ctccalls	8-15
8.2.13	Monitor Downstream	8-15
8.2.14	Monitor Event	8-15
8.2.15	Monitor Explorer	8-16
8.2.16	Monitor FastRecovery	8-17
8.2.17	Monitor Flostalls	8-17
8.2.18	Monitor Flow	8-17
8.2.19	Monitor Frontend	8-18
8.2.20	Monitor Group	8-18
8.2.21	Monitor Ipc	8-19
8.2.22	Monitor Ipcrate	8-20
8.2.23	Monitor Jcalls	8-21
8.2.24	Monitor Journal	8-21
8.2.25	Monitor Juse	8-22
8.2.26	Monitor Link	8-22
8.2.27	Monitor Lrc	8-23
8.2.28	Monitor Management	8-24
8.2.29	Monitor Netbytes	8-25
8.2.30	Monitor Netstat	8-26
8.2.31	Monitor Ortr	8-27
8.2.32	Monitor Partit	8-27
8.2.33	Monitor Queues	8-28
8.2.34	Monitor Quorum	8-28
8.2.35	Monitor Recovery	8-29
8.2.36	Monitor Rejects	8-30
8.2.37	Monitor Rejhist	8-31
8.2.38	Monitor Response	8-31
8.2.39	Monitor Rolequor	8-32

8.2.40	Monitor Routers	8-32
8.2.41	Monitor Routing	8-33
8.2.42	Monitor Rscbe	8-33
8.2.43	Monitor Stalls	8-34
8.2.44	Monitor Stccalls	8-35
8.2.45	Monitor Summary	8-35
8.2.46	Monitor System	8-37
8.2.47	Monitor Tps	8-38
8.2.48	Monitor Tpslo	8-39
8.2.49	Monitor Traffic	8-39
8.2.50	Monitor Trans	8-39
8.2.51	Monitor Upstream	8-40
8.2.52	Monitor V2calls	8-40
8.2.53	Monitor Wq_facility	8-41
8.2.54	Monitor Wq_process	8-41
8.2.55	Monitor XA	8-42

9 RTR Commands

9.1	Introduction	9-1
9.2	RTR Command Reference	9-2
	ADD FACILITY	9-3
	CALL RTR_ACCEPT_TX	9-4
	CALL RTR_BROADCAST_EVENT	9-8
	CALL RTR_CLOSE_CHANNEL	9-13
	CALL RTR_ERROR_TEXT	9-16
	CALL RTR_EXT_BROADCAST_EVENT	9-18
	CALL RTR_GET_TID	9-23
	CALL RTR_GET_USER_CONTEXT	9-26
	CALL RTR_OPEN_CHANNEL	9-28
	CALL RTR_RECEIVE_MESSAGE	9-39
	CALL RTR_REJECT_TX	9-44
	CALL RTR_REPLY_TO_CLIENT	9-47
	CALL RTR_REQUEST_INFO	9-52
	CALL RTR_SEND_TO_SERVER	9-55
	CALL RTR_SET_USER_CONTEXT	9-60
	CALL RTR_START_TX	9-62
	CLEAR	9-66
	CREATE CONNECTIONPOOL	9-68
	CREATE DATASOURCE	9-72

CREATE FACILITY	9-74
CREATE JOURNAL	9-79
CREATE PARTITION	9-83
CREATE SERVICEPROVIDER	9-89
DEFINE /KEY	9-92
DELETE CONNECTIONPOOL	9-96
DELETE DATASOURCE	9-98
DELETE FACILITY	9-100
DELETE JOURNAL	9-102
DELETE PARTITION	9-104
DELETE SERVICEPROVIDER	9-106
DISCONNECT LINK	9-108
DISCONNECT SERVER	9-111
DISPLAY BAR	9-113
DISPLAY NUMERIC	9-121
DISPLAY STRING	9-128
DISPLAY SYMBOLIC	9-134
DISPLAY TEXT	9-138
DO	9-143
DUMP JOURNAL	9-146
EXECUTE	9-154
EXIT	9-155
EXPORT COUNTERS	9-156
EXTEND FACILITY	9-158
FLUSH NAME_CACHE	9-164
INITIALIZE JOURNAL	9-166
LOG	9-167
MODIFY CONNECTIONPOOL	9-169
MODIFY DATASOURCE	9-173
MODIFY JOURNAL	9-175
MODIFY SERVICEPROVIDER	9-178
MONITOR	9-181
QUIT	9-185
RECALL	9-186
REGISTER RESOURCE_MANAGER (REGISTER RM)	9-188
REMEMBER EXPRESSION	9-191
RTR	9-194

SCROLL	9-195
SET ENVIRONMENT	9-197
SET FACILITY	9-199
SET LINK	9-202
SET LOG	9-207
SET MODE	9-211
SET NODE	9-214
SET PARTITION	9-219
SET TRANSACTION	9-224
SHOW CHANNEL	9-229
SHOW CLIENT	9-231
SHOW CONNECTIONPOOL	9-233
SHOW DATASOURCE	9-235
SHOW DISPLAY	9-237
SHOW ENVIRONMENT	9-239
SHOW FACILITY	9-240
SHOW JOURNAL	9-245
SHOW KEY	9-248
SHOW LINK	9-250
SHOW LOG	9-253
SHOW MODE	9-255
SHOW NODE	9-257
SHOW PARTITION	9-260
SHOW PROCESS	9-265
SHOW REQUESTER	9-267
SHOW RESOURCE_MANAGER (SHOW RM)	9-268
SHOW RTR	9-271
SHOW SEGMENT	9-274
SHOW SERVER	9-276
SHOW SERVICEPROVIDER	9-280
SHOW TRANSACTION	9-282
SHOW VERSION	9-287
SPAWN	9-288
START HTTP_SERVER	9-290
START RTR	9-291
STOP HTTP_SERVER	9-299
STOP RTR	9-300

TRIM FACILITY	9-302
UNREGISTER RESOURCE_MANAGER (UNREGISTER RM)	9-306

A Creating Customized RTR Monitor Pictures

A.1	Interactive Definition of a Monitor Picture	A-3
A.2	Substitution Symbols	A-5
A.3	Arithmetic Expressions and Operators	A-6
A.4	Monitoring Memory Usage	A-9

B Customizing the RTR Web Browser Interface

B.1	Style Customization	B-1
B.1.1	RTR Style Names	B-2
B.1.2	Examples	B-3
B.2	Server Security	B-4
B.2.1	User Authentication	B-4
B.2.2	User Credentials Caching	B-5
B.2.3	Break-in Detection and Evasion	B-5

C RTR XA Support

C.1	Introduction	C-1
C.2	Invoking RTR XA Support	C-2
C.2.1	Registering a Resource Manager	C-2
C.2.2	Associating a Resource Manager with a Facility	C-2
C.2.3	Binding a Resource Manager with a Partition	C-3
C.2.4	Opening an RTR Channel	C-3
C.3	MONITOR XA	C-3
C.4	Microsoft DTC Support	C-4

D RTR Utility Messages

D.1	Utility Error Messages	D-1
-----	------------------------------	-----

E RTR Log Messages

E.1	Operator Log Messages	E-1
-----	-----------------------------	-----

Index

Examples

2-1	Local Configuration of Each Node	2-3
2-2	Remote Setup from One Node	2-4
2-3	Reconfiguration Using TRIM FACILITY	2-8
2-4	Reconfiguration Using EXTEND FACILITY	2-10
2-5	Configuration of Callout Servers	2-13
2-6	SHOW PARTITION/FULL for Routers	2-47
2-7	SHOW PARTITION/FULL for Backends	2-47
8-1	Monitor Accfail	8-6
8-2	Monitor Acp2app	8-8
8-3	Monitor Active	8-8
8-4	Monitor Alarm	8-9
8-5	Monitor App2acp	8-10
8-6	Monitor Appdelay	8-10
8-7	Monitor Broadcast	8-11
8-8	Monitor Calls	8-12
8-9	Monitor Channel	8-12
8-10	Monitor Compress	8-14
8-11	Monitor Connects	8-14
8-12	Monitor Ctccalls	8-15
8-13	Monitor Downstream	8-15
8-14	Monitor Event	8-16
8-15	Monitor Explorer	8-16
8-16	Monitor FastRecovery	8-17
8-17	Monitor Flostalls	8-17
8-18	Monitor Flow	8-17
8-19	Monitor Frontend	8-18
8-20	Monitor Group	8-18
8-21	Monitor Ipc	8-19
8-22	Monitor Ipcrate	8-20

8-23	Monitor Jcalls	8-21
8-24	Monitor Journal	8-22
8-25	Monitor Juse	8-22
8-26	Monitor Link	8-23
8-27	Monitor Lrc	8-24
8-28	Monitor Management	8-25
8-29	Monitor Netbytes	8-26
8-30	Monitor Netstat	8-26
8-31	Monitor Ortr	8-27
8-32	Monitor Partit	8-27
8-33	Monitor Queues	8-28
8-34	Monitor Quorum	8-29
8-35	Monitor Recovery	8-29
8-36	Monitor Rejects	8-30
8-37	Monitor Rejhist	8-31
8-38	Monitor Response	8-32
8-39	Monitor Rolequor	8-32
8-40	Monitor Routers	8-33
8-41	Monitor Routing	8-33
8-42	Monitor Rscbe	8-34
8-43	Monitor Stalls	8-35
8-44	Monitor Stccalls	8-35
8-45	Monitor Summary	8-36
8-46	Monitor System	8-37
8-47	Monitor Tps	8-38
8-48	Monitor Tpslo	8-39
8-49	Monitor Traffic	8-39
8-50	Monitor Trans	8-40
8-51	Monitor Upstream	8-40
8-52	Monitor V2calls	8-41
8-53	Monitor Wq_facility	8-41
8-54	Monitor Wq_process	8-42
8-55	Monitor XA	8-42
9-1	DUMP JOURNAL Brief Output	9-151
9-2	DUMP JOURNAL Full Output	9-152
A-1	Interactive Monitor Picture Definition	A-3
A-2	Interactively Defined Monitor Picture	A-4

A-3	Interactive Use of Remember Expression	A-4
A-4	Interactive Use of Remember Expression	A-5
A-5	Arithmetic Operators Examples	A-7

Figures

1	RTR Reading Path	xxii
1-1	RTR Administrator Screen	1-5
1-2	Select HTTP Server	1-7
1-3	RTR Security Dialog Box	1-8
1-4	RTR Manager Screen	1-9
1-5	RTR Explorer	1-10
1-6	RTR Explorer - Navigation Mode, All-Facility View	1-12
1-7	RTR Explorer - Alarm Screen	1-13
1-8	RTR Explorer Facility OK Icon	1-14
1-9	RTR Explorer Facility Warning Icon	1-14
1-10	RTR Explorer Facility Error Icon	1-14
1-11	RTR Explorer Facility Fatal Icon	1-14
1-12	RTR Node OK Icon	1-15
1-13	RTR Node Warning Icon	1-15
1-14	RTR Node Error Icon	1-15
1-15	RTR Node Fatal Icon	1-15
1-16	RTR Node-Group OK Icon	1-15
1-17	RTR Node-Group Warning Icon	1-15
1-18	RTR Node-Group Error Icon	1-15
1-19	RTR Node-Group Fatal Icon	1-16
1-20	RTR Explorer - Single Facility View	1-17
1-21	RTR No-Group Icon	1-17
1-22	RTR Group-By-Cluster Icon	1-18
1-23	RTR Group-By-Partition Icon	1-18
1-24	RTR Group-By Cluster-Then-Partition Icon	1-18
1-25	RTR Group-By Partition-Then-Cluster Icon	1-18
2-1	RTR Configuration	2-2
2-2	Extend Configuration	2-9
2-3	Dual-Rail Configuration with Network Cards on a Router	2-40
2-4	Dual-Rail Configuration with Network Cards on a Frontend	2-41

2-5	Assignment of Sequence Numbers in a Shadow Configuration	2-48
2-6	Sample OpenVMS Cluster Running RTR	2-51
5-1	Backend Server States	5-10
5-2	Frontend Client States	5-11
5-3	Router Partition States	5-13
6-1	Performance Chart in RTR Performance Monitor	6-2

Tables

1	RTR Documents	xviii
2	Conventions Used in this Guide	xx
1-1	Incomplete Indicator	1-19
1-2	Updating Incomplete Data	1-19
2-1	Virtual Memory Allowances	2-19
2-2	Rules for CHANNELCNT and MAXPROCCNT	2-28
2-3	RTR Environment Variables	2-29
2-4	Steps to Assigning Sequence Numbers	2-48
4-1	Transaction Journal States	4-2
4-2	Valid Transaction State Transitions	4-5
5-1	RTR Partition States	5-2
7-1	Physical Location of RTR Error Log	7-11
8-1	Standard Monitor Pictures	8-2
8-2	MONITOR GROUP Fields	8-18
8-3	Monitor Management Fields	8-24
8-4	Monitor Partition States	8-27
8-5	Monitor Recovery States	8-29
8-6	Monitor Rejects Fields	8-30
8-7	Monitor Rejhist Fields	8-31
8-8	Default Thresholds	8-38
9-1	Parameters for rtr_accept_tx	9-5
9-2	Parameters for rtr_broadcast_event	9-9
9-3	Generated Format Strings	9-11
9-4	Parameters for rtr_close_channel	9-14
9-5	Parameters for rtr_error_text	9-16
9-6	Parameters for rtr_ext_broadcast_event	9-19
9-7	Generated Format Strings	9-21

9-8	Parameters for <code>rtr_get_tid</code>	9-24
9-9	Parameters for <code>rtr_get_user_context</code>	9-26
9-10	Parameters for <code>rtr_open_channel</code>	9-30
9-11	Parameters for <code>rtr_receive_message</code>	9-40
9-12	Parameters for <code>rtr_reject_tx</code>	9-45
9-13	Parameters for <code>rtr_reply_to_client</code>	9-48
9-14	Generated Format Strings	9-49
9-15	Parameters for <code>rtr_request_info</code>	9-53
9-16	Parameters for <code>rtr_send_to_server</code>	9-56
9-17	Generated Format Strings	9-58
9-18	Parameters for <code>rtr_set_user_context</code>	9-60
9-19	Parameters for <code>rtr_start_tx</code>	9-63
9-20	Platform-Specific Information	9-80
9-21	Key Names	9-93
9-22	Valid Transaction State Changes	9-227
9-23	Key-Range or Partition States	9-260
9-24	Router Partition States	9-261
9-25	Recovery Version	9-272
9-26	Key-Range States	9-276
9-27	Server Flags	9-277
9-28	Transaction Invocation Types	9-283
9-29	Key-Range States	9-285
A-1	Information Classes	A-2
A-2	Substitution Symbols	A-5
A-3	Arithmetic Operators in Display Commands	A-6
A-4	RTR Wait Queue Node Counters	A-9
A-5	RTR Wait Queue Facility Counters	A-9
A-6	RTR Wait Queue Process Counters	A-10
B-1	RTR Style Names	B-2

Purpose of this Manual

This manual describes how to configure, manage and monitor the operation of Reliable Transaction Router (RTR) using the RTR Administrator, a web browser interface, and the RTR Command Line Interface (CLI).

Intended Audience

The *HP Reliable Transaction Router System Manager's Manual* is intended for persons who perform system management functions to configure, test, monitor and maintain RTR applications.

Readers are assumed to be familiar with the operating systems on which RTR and its applications are running.

For a general overview of RTR and an introduction to RTR transaction processing and failure tolerant concepts, read the *HP Reliable Transaction Router Getting Started* manual.

Structure of Document

The manual contains the following chapters and appendices:

- Chapter 1 introduces the RTR Administrator with its RTR Explorer and RTR Manager web browser interfaces, the RTR Command Line Interface (CLI) and the RTR help system; it also explains how to use local and remote commands, and command procedures.
- Chapter 2 explains how to configure and start RTR.
- Chapter 3 describes how to use RTR to manage partitions.
- Chapter 4 provides information on managing transactions with RTR.
- Chapter 5 describes RTR server shadowing and recovery.
- Chapter 6 describes use of the standard Windows Administrative Tools Performance utility to capture and display certain RTR counters.

- Chapter 7 identifies ways to diagnose and correct problems in RTR networks.
- Chapter 8 describes how to use the RTR Monitor Utility to observe the performance and operation of RTR and applications that use RTR.
- Chapter 9 describes all RTR commands. Commands are listed alphabetically.
- Appendix A explains how to create your own monitor pictures for special monitoring needs.
- Appendix B explains how to customize the appearance of RTR web browser HTML pages, and explains server security.
- Appendix C describes how to use RTR with XA in an ORACLE environment.
- Appendix D contains the list of messages that can be returned by RTR, by either the RTR browser interface, the RTR CLI, or by applications that run RTR.
- Appendix E contains the list of all messages that RTR can write to the RTR log.

Related Documentation

Table 1 describes RTR documents and groups them by audience.

Table 1 RTR Documents

Document	Content
For all users:	
<i>HP Reliable Transaction Router Release Notes¹</i>	Describes new features, corrections, restrictions, and known problems for RTR.
<i>HP Reliable Transaction Router Getting Started</i>	Provides an overview of RTR technology and solutions, and includes the glossary that defines all RTR terms.
<i>HP Reliable Transaction Router Software Product Description</i>	Describes product features.
For the system manager:	

¹Distributed on software kit.

(continued on next page)

Table 1 (Cont.) RTR Documents

Document	Content
<i>HP Reliable Transaction Router Installation Guide</i>	Describes how to install RTR on all supported platforms.
<i>HP Reliable Transaction Router System Manager's Manual</i>	Describes how to configure, manage, and monitor RTR.
For the application programmer:	
<i>HP Reliable Transaction Router Application Design Guide</i>	Describes how to design application programs for use with RTR, with both C++ and C interfaces.
<i>HP Reliable Transaction Router JRTR Getting Started</i> ²	Provides an overview of the object-oriented JRTR Toolkit including installation, configuration and Java programming concepts, with links to additional online documentation.
<i>HP Reliable Transaction Router C++ Foundation Classes</i>	Describes the object-oriented C++ interface that can be used to implement RTR object-oriented applications.
<i>HP Reliable Transaction Router C Application Programmer's Reference Manual</i>	Explains how to design and code RTR applications using the C programming language and the RTR C API. Contains full descriptions of the basic RTR API calls.

²In downloadable kit.

You can find additional information about RTR, including the Software Product Descriptions, on the RTR website found through <http://www.hp.com> links to middleware products or at <http://www.hp.com/go/rtr> .

Reader's Comments

HP welcomes your comments on this manual. Please send comments to either of the following addresses:

Internet	openvmsdoc@hp.com
Postal Mail	Hewlett-Packard Company RTR Documentation Group, ZKO3-4/Y17 110 Spit Brook Rd. Nashua, NH 03062-2698

Include the title of the manual, date, section and page numbers with your comments or suggestions.

Conventions

Table 2 describes the conventions used in this guide.

Table 2 Conventions Used in this Guide

Convention	Meaning
UPPERCASE lowercase	Some operating systems differentiate between lowercase and uppercase characters. For these systems, you must enter examples, syntax descriptions, function definitions, and literal strings exactly as shown. Commands typed to the RTR CLI are <i>not</i> case sensitive unless enclosed in quotation marks.
#	A number sign (#) is the default operating system superuser prompt on UNIX systems.
%	A percent sign (%) is the default operating system user prompt on UNIX systems.
\$	A dollar sign (\$) is the default operating system user prompt on OpenVMS systems.
Return	In examples, a boxed symbol indicates that you must press the named key on the keyboard.
Ctrl/C	This symbol indicates that you must press the Ctrl key while you simultaneously press another key (in this case, C).
user input	In interactive examples, this typeface indicates input entered by the user.
<i>italic text</i>	Italic text emphasizes important information, indicates variables, and complete titles of manuals. Italic text also represents information that can vary in system messages (for example, internal error <i>number</i>), command lines (for example, /PRODUCER= <i>name</i>), and command parameters in text.
boldface text	Boldface text represents the introduction of a new term or the name of an argument, an attribute, or a reason.
UPPERCASE TEXT	Uppercase text indicates a command, the name of a routine, the name of a file, or the abbreviation for a system privilege.
system output	This typeface is used in interactive and code examples to indicate system output.
[y]	In a prompt, square brackets indicate that the enclosed item is the default response. For example, [y] means the default response is Yes.

(continued on next page)

Table 2 (Cont.) Conventions Used in this Guide

Convention	Meaning
-	In command line examples, a hyphen (-) is the continuation character, allowing a long command to be continued on the following line.

Reading Path

The reading path to follow when using the Reliable Transaction Router information set is shown in Figure 1.

Figure 1 RTR Reading Path

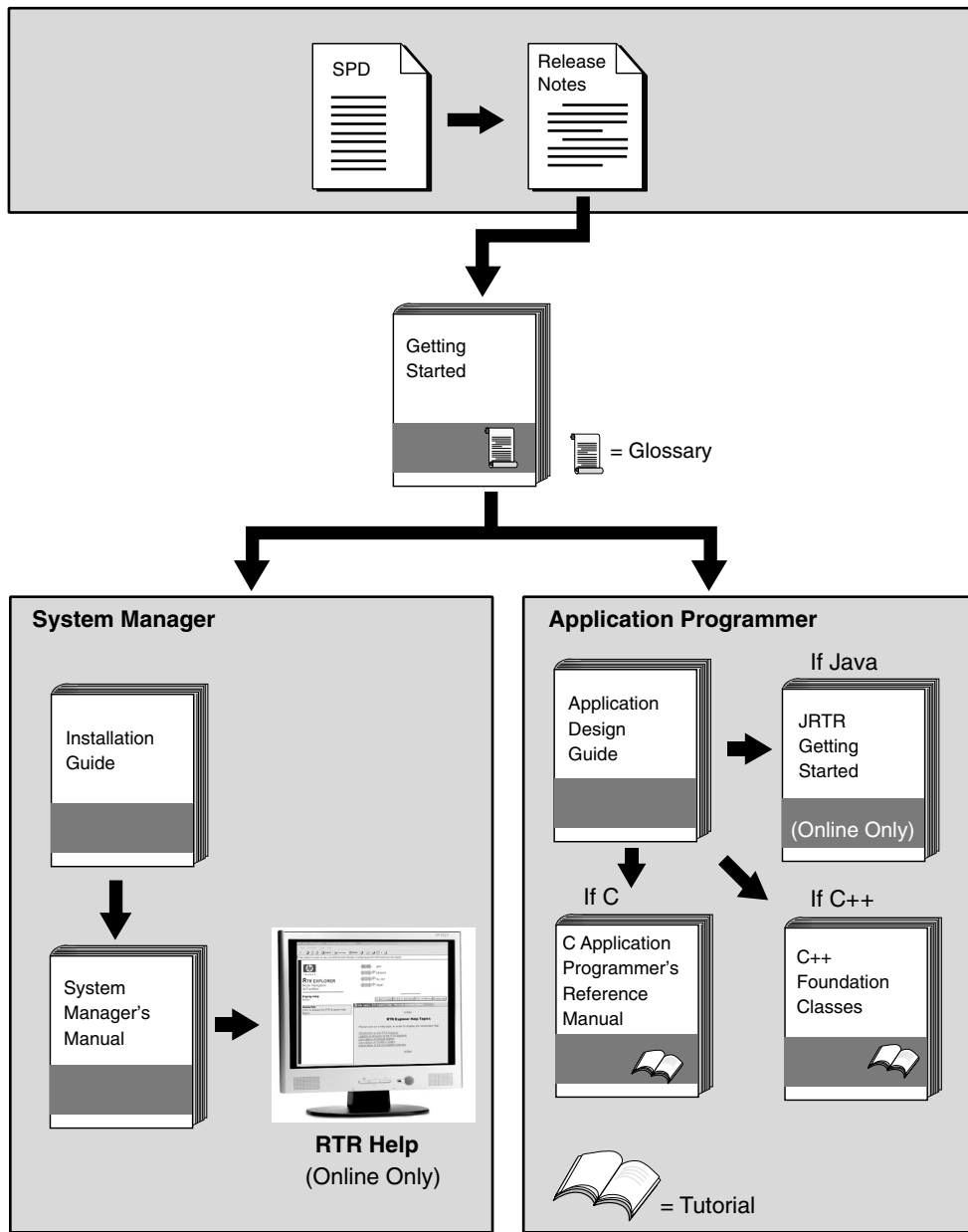

VM-0818A-AI

Introduction

For a general introduction to HP Reliable Transaction Router (RTR), read the *HP Reliable Transaction Router Getting Started* manual. This is a prerequisite before using this manual for the system manager. Additional information about RTR is available in the other documents in the HP Reliable Transaction Router information set and from the RTR web browser and command line interfaces.

To use RTR, you must first install the RTR software and create and install your application. See the *HP Reliable Transaction Router Installation Guide* for instructions on how to install RTR.

RTR applications can use the C API calls described in the *HP Reliable Transaction Router C Application Programmer's Reference Manual* and the C++ API classes described in the *HP Reliable Transaction Router C++ Foundation Classes* manual.

1.1 Initial Setup

Before an RTR application can be used, RTR must be started on every node that is defined as part of your RTR configuration. You do this by issuing a `START RTR` command on each node. You can include the `START RTR` command in a startup command procedure, script or `.bat` file for each node, starting RTR whenever a node is booted. Note that RTR cannot start until after the network has started. For details on how to use startup procedures, see your operating system documentation. For information on installing RTR, see the *HP Reliable Transaction Router Installation Guide*.

After RTR is started, you must create the recovery journal files for RTR on specified disks. Use the `RTR CREATE JOURNAL` command to create journal files.

Introduction

1.1 Initial Setup

Note

While configuring RTR on HP-UX and Linux for Integrity servers (I64) in ACTIVE/STANDBY mode, a journal should be created in the shared disk (Cluster File System (CFS)/Global File System (GFS)), that is accessible from all the nodes configured in the cluster.

For RTR to work in ACTIVE/STANDBY mode, the following environmental variables must be set:

- **RTR_CLU_MEM_NODES**: This variable enables RTR to recognize the backend nodes of the cluster participating in ACTIVE/STANDBY mode.
For example:
`RTR_CLU_MEM_NODES="BE1, BE2"`
- **RTR_CLU_LCK_DISK**: This variable enables RTR to maintain the "cluster node locks" on a common shared disk in the cluster. All backend nodes in the cluster should use the same disk for maintaining "cluster node locks".
For example:
`RTR_CLU_LCK_DISK= "/dev/vx/dsk/rtrdata/rtr_files"`
- for HP-UX I64

You should also create a log file to log RTR messages with the RTR SET LOG command.

A separate **facility** must be defined for each application. An RTR facility is the user-defined name that provides the mapping between nodes and roles for a given application. Before starting application processes, use the RTR CREATE FACILITY command to define a facility. You may choose to include CREATE FACILITY in the command procedure used to start the application. For examples of configurations, see the *HP Reliable Transaction Router Getting Started* manual.

1.2 Administering RTR and RTR Applications

RTR is started, configured, and maintained by using either the RTR Administrator web browser interface or the RTR Command Line Interface (CLI). Either interface is used to start, set up, and monitor the operation of RTR. An application written with the C++ API can also start RTR. For more information on system management from an application, see the *HP Reliable Transaction Router C++ Foundation Classes* manual.

1.3 RTR Administrator

The RTR Administrator has two parts, the RTR Manager and the RTR Explorer. Both are browser-based interfaces. This feature is supported on Internet Explorer, Netscape 7.0+ and Mozilla. Help is available in popups and through strategically placed help buttons.

To start RTR Administrator functions, follow these steps:

1. **From the OpenVMS or any UNIX** system prompt, start the HTTP server on the target computer system by using the following command:

```
% rtr start http_server
```

This command must be issued for each user of the management features.

Operating System Prompt Symbol

The user prompt for the operating system is shown here as the percent (%) symbol. Your system may show a different prompt.

The system manager can issue the command on behalf of each user when the system starts up, or each user can issue the command by logging into the target system or by issuing a remote command such as rsh.

On Windows, with RTR installed, the RTR command window will be displayed. If not, click Start then Programs then HP then RTR then Reliable Transaction Router. The RTR command window will be displayed. Enter the command start http_server to start the http server.

(The following qualifier to the start http_server command starts the servers as read-only:

```
/access=read_only
```

Read-only servers execute only the equivalent of the command-line-interface commands SHOW and MONITOR.)

Note that you should set your browser security to medium/low (See Appendix B).

2. Start the RTR Administrator browser by opening the file rtr_main.html. This file is located in one of the following operating system-dependent directories where RTR is installed:

Introduction

1.3 RTR Administrator

Server Operating System	File Location
HP-UX	/opt/rtr/wbi
Linux	/var/opt/rtr
OpenVMS	RTR\$DIRECTORY
Windows	RTR installation directory

If RTR is not installed on the computer where the browser is running, use the URL `http://<hostname>:46000/rtr_main.html` to display the RTR Manager screen from a system where the HTTP server has been started.

On Windows, to start the RTR Administrator, click Start then Programs then HP then RTR then Web Browser Interface. This brings up the RTR Administrator screen.

Figure 1–1 RTR Administrator Screen

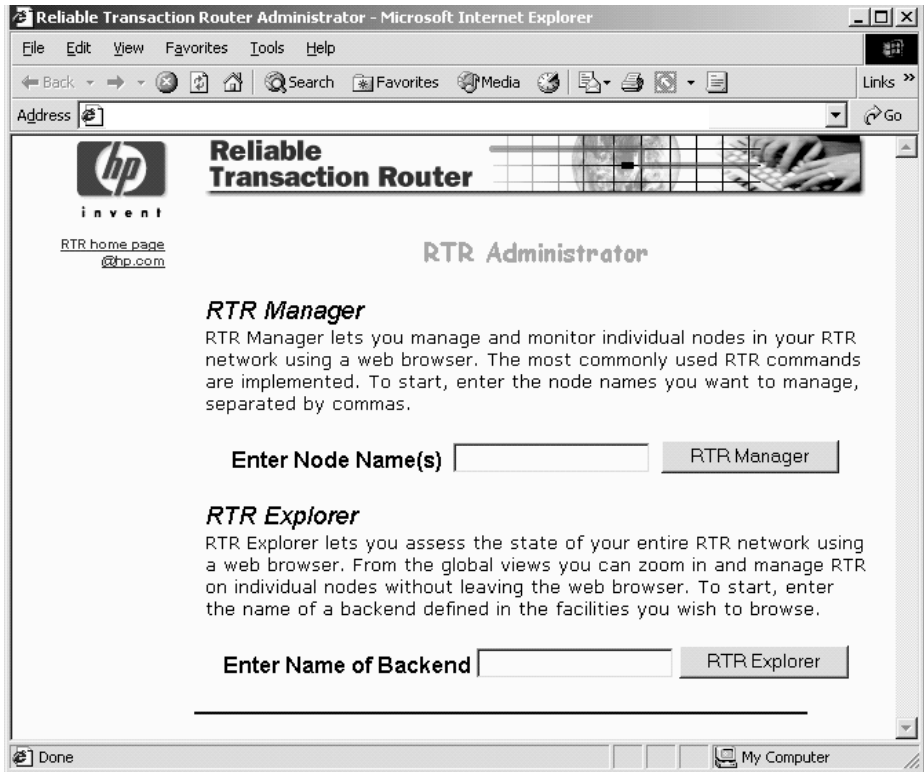

vm-1152A-AI

3. When the RTR Administrator screen, Figure 1–1, appears, you can select whether to use the RTR Manager or RTR Explorer. The RTR Explorer graphically shows the configuration of each facility and provides alert mechanisms for viewing node, facility, and partition status. The RTR Manager provides extensive graphical monitoring mechanisms and provides a graphical menu of the most commonly used RTR commands.
4. To access the RTR Manager, enter the names of the nodes you wish to manage in the text box labeled “Enter Node Name(s),” and click the RTR Manager button. You can manage more than one node at a time by entering a comma-separated list of node names. RTR Manager can manage any node running an RTR HTTP server with RTR V4.0 or higher.

Introduction

1.3 RTR Administrator

To access RTR Explorer, enter the name of the backend in the text box labeled “Enter Name of Backend,” and click the RTR Explorer button. Only a backend node will have the information needed to run the RTR Explorer for each facility in which it participates. Any backend running an RTR HTTP server with RTR V5.0 or higher installed can run RTR Explorer.

To access either RTR Manager or RTR Explorer on the local node, type nothing in either text box, and click the RTR Manager or RTR Explorer button, respectively. Your local node is the default.

5. A list of running HTTP servers will be shown on the next page. Choose the username corresponding to the HTTP server to which you wish to connect, as shown in Figure 1–2. If you have not started one, return to Step 1 and start one.

The following screen lets you select the RTR http server. Your selection is permanent for your browser session.

To change your selection, close your current browser window, reopen a new browser window and repeat Steps 1 through 5 with a new selection.

Figure 1–2 Select HTTP Server

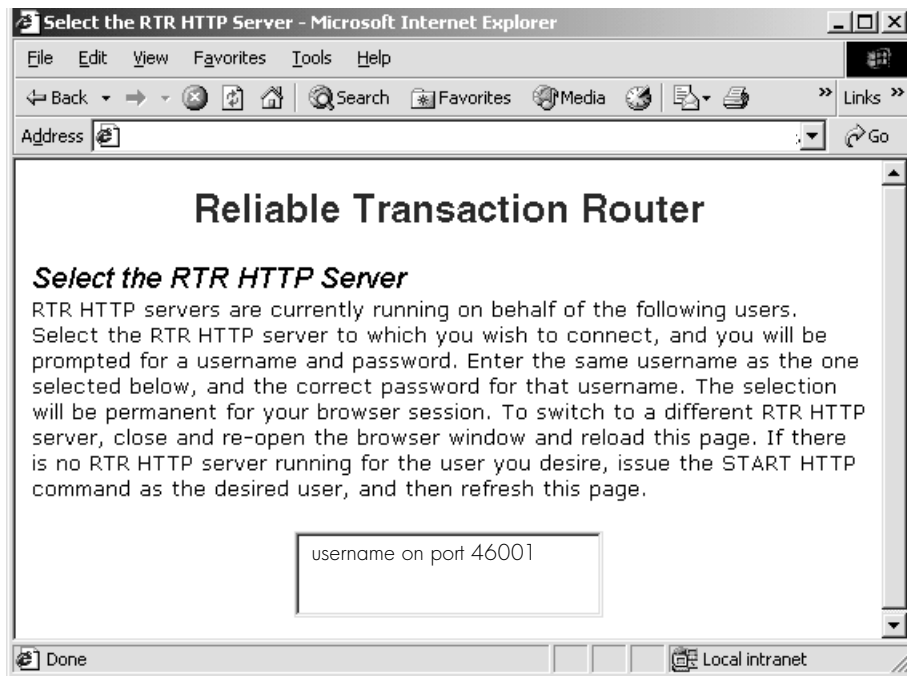

vm-1153A-AI

Introduction

1.3 RTR Administrator

6. The RTR Security dialog box, Figure 1–3, appears. Enter your username and password. Enter exactly the same username that was selected in Step 5. Do not prefix or suffix the username with a domain name, node name, or any other information. Enter exactly the same password you used to log into the system to start the HTTP server.

If incorrect credentials are given too many times, authentication is temporarily disabled as a security measure. You may either wait until authentication has been re-enabled, or stop and restart the RTR HTTP server.

Figure 1–3 RTR Security Dialog Box



VM-1092-AI

7. Either the RTR Manager screen, Figure 1–4, or the RTR Explorer screen, Figure 1–5, appears, depending on your selection.

Figure 1–4 RTR Manager Screen

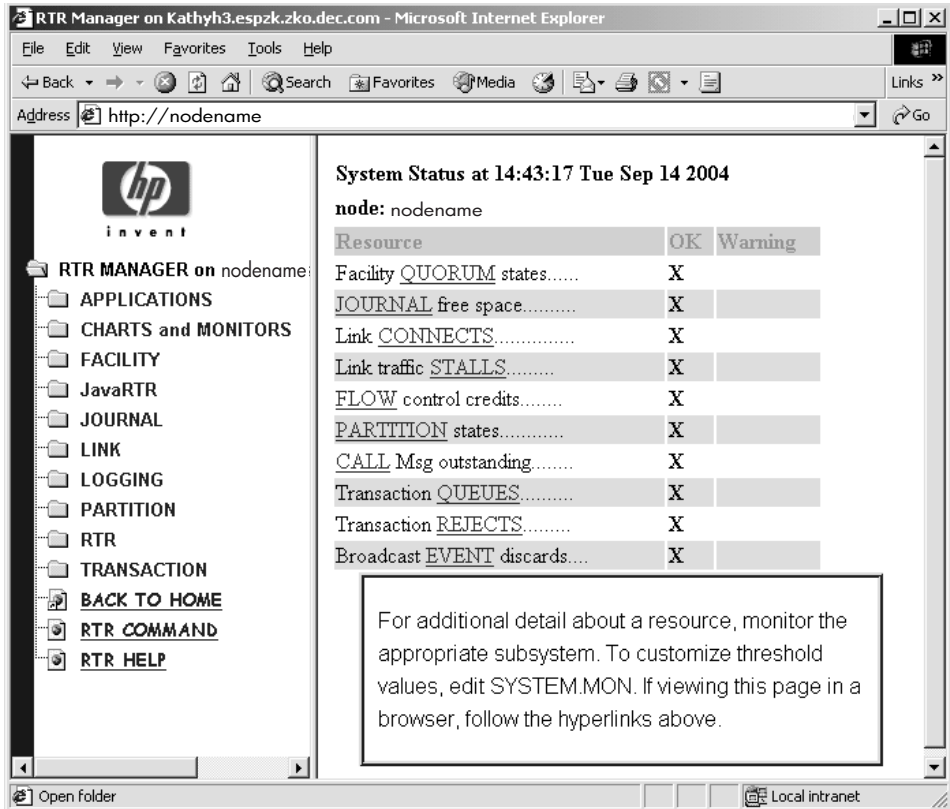

VM-1158A-AI

Introduction

1.3 RTR Administrator

Figure 1–5 RTR Explorer

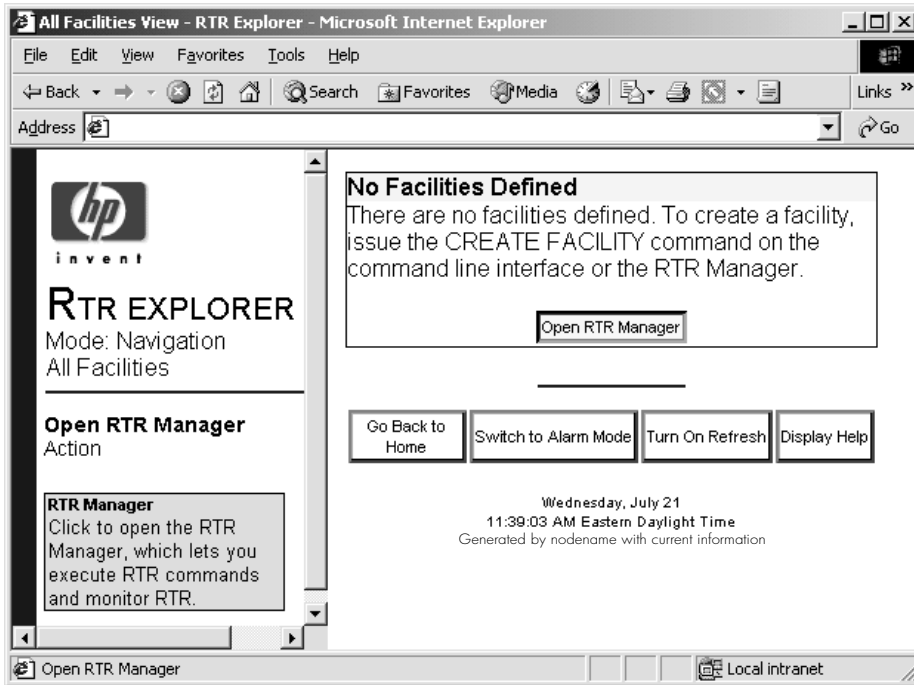

vm-1154A-AI

1.3.1 RTR Manager

The RTR Manager provides access to commands and displays with which you manage RTR, its facilities, nodes, logs, and partitions. The RTR Manager also provides enhanced graphical monitoring capabilities superior to the RTR CLI. Rows are color-coded, hyperlinks are available, and popups describe the content of monitor screens. Most RTR CLI commands are also available through the RTR Manager screen when you click on the RTR Command link.

In addition, the browser interface provides context-sensitive help for commands where user input is required, informational popups on certain headings such as "Resource," and details of a facility, partition, link, or transaction with links through browser popups. For example, to see details of a defined partition, click on the "show partition x details" popup seen when placing your mouse on a blue-underlined partition name.

Node Lists

In the browser interface, node lists are built from the contents of the local hosts file. You should add the names and addresses of current and potential nodes in your configuration to the local hosts file. In some cases you must enter the fully-qualified path name such as `http://node.domain`, to reach the node you want to manage, in facility definitions, and when using a web browser.

For information about server security and customizing the appearance of the RTR Administrator interface, see Appendix B.

1.3.2 RTR Explorer

The RTR Explorer interface enables the system administrator to monitor all nodes in the facilities defined for RTR, to navigate to all nodes in the RTR network, drill down to specific nodes, and receive automatic notification of warning, error, or fatal alarms. Nodes are self-monitoring; they detect faults in RTR nodes, roles, links, or partitions.

When everything is normal, RTR Explorer shows all nodes in graphical displays, and presents an alert when the state of a node or facility changes to an abnormal state. Three alarm levels are shown in color and an increasing number of flags: Warning (yellow, one flag), Error (orange, two flags) and Fatal (red, three flags).

Introduction

1.3 RTR Administrator

Figure 1–6 shows an all-facility view with several alarm states. Buttons on the right pane let you Go Back to Home (the RTR Administrator screen), Switch to Alarm Mode, Turn On (or Off) Refresh, and Display Help.

The mouse pointer is over the “Go Back to Home” button, showing instructions in the bottom left information pane.

Figure 1–6 RTR Explorer - Navigation Mode, All-Facility View

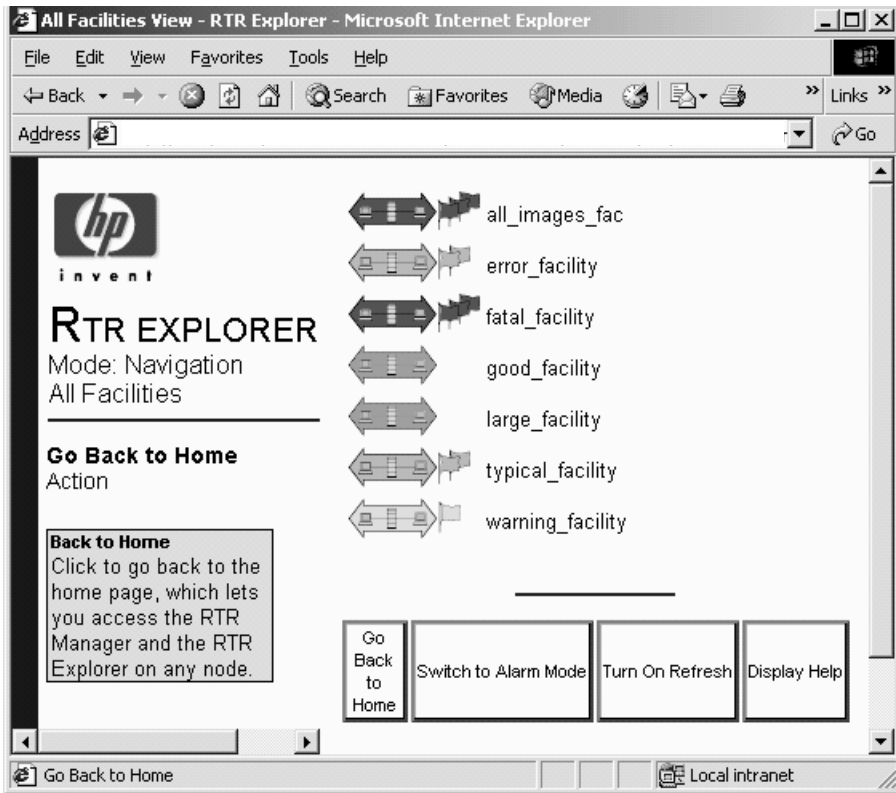

vm-1155A-AI

To find which node is sending an alarm and information about the alarm, click on the facility you want to examine. For example, the result when you click on the “all_images_fac” facility at the top of Figure 1–6 is shown in Figure 1–7. This node-and-alarm view provides information about each node in the facility that has an alarm. For more information about RTR icons, see Section 1.3.2.1. For information about RTR Explorer Help (viewed from the Display Help button), see Section 1.3.2.2.

Figure 1–7 RTR Explorer - Alarm Screen

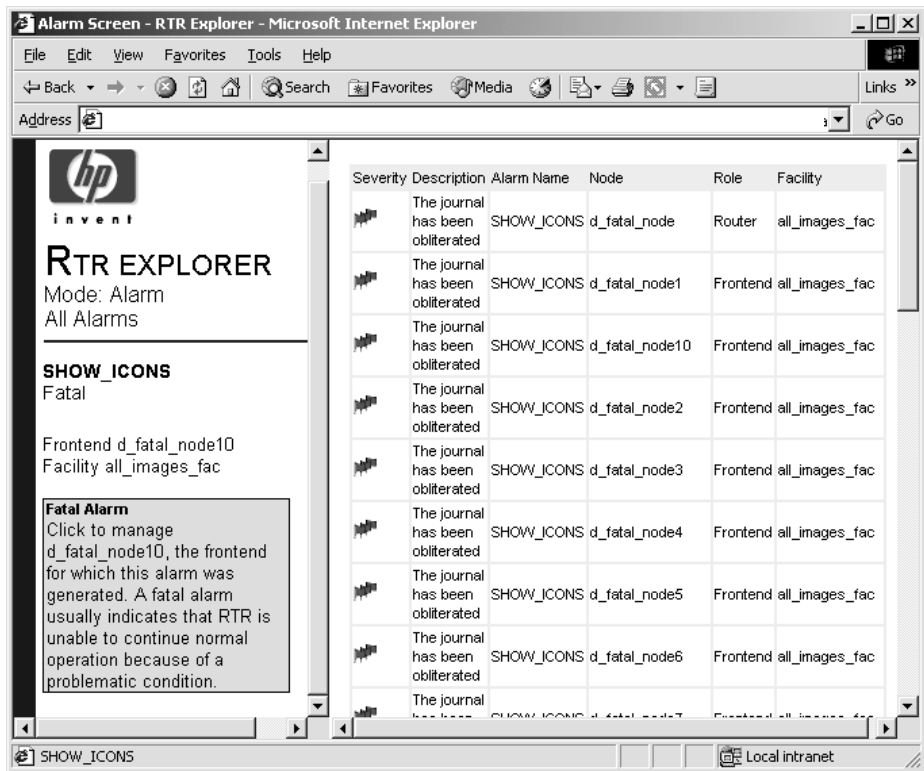

vm-1156A-AI

1.3.2.1 RTR Explorer Icons

Explorer icons indicate states for nodes, facilities and partitions to assist you in finding and correcting the source of an alarm. Icons have a well-defined hierarchy from OK (green, no flags), through Warning (yellow, one flag) and Error (orange, two flags) to Fatal (red, three flags). The flags assist users who are color blind.

Several icon types assist your use of RTR:

- Alarm icons (flags only, on the alarm screen)
- Facility icons
- Node icons
- Node-group icons
- Group-by icons

Introduction

1.3 RTR Administrator

- Partition-state icons (described in Chapter 3).

When you place your mouse pointer over an icon or button, an information pane appears (lower left) describing the object under the mouse pointer. More detail on icons is available in the RTR Explorer interface.

Facility Icons

The icon status of a facility corresponds to the most serious status in the facility. To view the nodes in a specific facility and their individual status, click on the facility icon. The facility icons are shown in Figure 1–8 to Figure 1–11.

Figure 1–8 RTR Explorer Facility OK Icon



Figure 1–9 RTR Explorer Facility Warning Icon

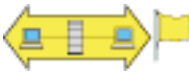

Figure 1–10 RTR Explorer Facility Error Icon



Figure 1–11 RTR Explorer Facility Fatal Icon



You obtain additional information to track down alarm origins using the node, node-group, and group-by-icons.

Node Icons

A node icon represents an individual node in an RTR facility; its status, shown by color and flags, represents the most serious alarm reported by that node. Node icons are shown in Figure 1–12 to Figure 1–15.

Figure 1–12 RTR Node OK Icon



Figure 1–13 RTR Node Warning Icon



Figure 1–14 RTR Node Error Icon



Figure 1–15 RTR Node Fatal Icon



Node-Group Icons

In a large configuration where node icons cannot fit on one screen, nodes are grouped alphabetically, and a group icon shows the status of each group. Nodename alphabetization is case-insensitive; for example, Y.Z.COM comes after a.b.com. Node-group icons are shown in Figure 1–16 to Figure 1–19.

Figure 1–16 RTR Node-Group OK Icon



Figure 1–17 RTR Node-Group Warning Icon



Figure 1–18 RTR Node-Group Error Icon



Introduction

1.3 RTR Administrator

Figure 1–19 RTR Node-Group Fatal Icon



For examples of node groups, use the RTR Explorer to examine your configuration.

Group-By Icons

When examining a facility, you can group backends in several ways:

- With no group
- By cluster
- By partition
- By cluster, then partition
- By partition, then cluster

Use these groupings to help you isolate the source of an alarm, as shown in Figure 1–20.

Figure 1–20 RTR Explorer - Single Facility View

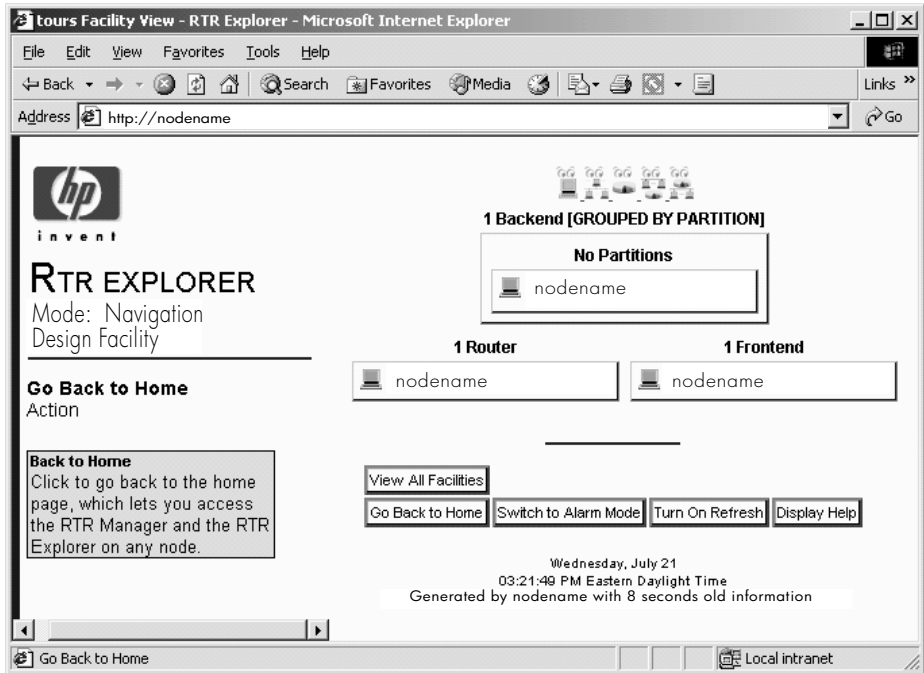

VM-1151A-AI

Group-by icons are shown in Figure 1–21 to Figure 1–25. Icons help remind you which grouping is shown, as follows:

Figure 1–21 RTR No-Group Icon



Introduction

1.3 RTR Administrator

Figure 1–22 RTR Group-By-Cluster Icon



Figure 1–23 RTR Group-By-Partition Icon



Figure 1–24 RTR Group-By Cluster-Then-Partition Icon



Figure 1–25 RTR Group-By Partition-Then-Cluster Icon



Partition State Icons Partition states show the current state of a given partition; they appear on the facility screen. They are described in Chapter 3.

1.3.2.2 RTR Explorer Help

RTR Explorer provides advice and information through the Display Help mouse click, and includes background on the accuracy of current RTR Explorer data shown in RTR Explorer screens. If a screen contains the word INCOMPLETE, your displayed data may be incomplete. For additional information, see Table 1–1 and Table 1–2.

Table 1–1 Incomplete Indicator

If you see:	It means that:
INCOMPLETE	<p>The backend gathering information could not gather all the information it needs to display the entire RTR network. The displayed information is accurate, but some frontend connection status may be missing.</p> <p>Some frontends may be erroneously marked as disconnected even though they are connected, because the backend may be unable to contact one or more routers to which the frontends are connected.</p>

The following explanations clarify the reasons why the data can be incomplete, and what can be done to fix the problems.

Table 1–2 Updating Incomplete Data

If you see the message:	The reason is:	To correct the problem:
Disconnected Routers	The node that generates the page needs to contact all routers in each facility to gather the information. If any of the required links are disconnected, the information will be incomplete.	Ensure that all router links are connected and that the facility configuration is consistent across the nodes. If your router is disconnected and the situation cannot be changed, try viewing the RTR Explorer from another backend. If the other backend is connected to all routers, the information will be complete.

(continued on next page)

Introduction

1.3 RTR Administrator

Table 1–2 (Cont.) Updating Incomplete Data

If you see the message:	The reason is:	To correct the problem:
RTR Version does not include the RTR Explorer	The RTR Explorer is only supported by RTR versions 5.0 and higher. The node that generated the page must contact all routers in each facility to gather the information. However, if any of the routers are not running RTR version 5.0 or higher, the node cannot request the information from the router, and the information will be incomplete.	To correct this problem, upgrade RTR on the offending routers.
Non-responsive Routers	The node that generated the page must contact all routers in each facility to gather the information. If one or more routers fail to respond within a timeout, the node deems the router as non-responsive and no longer waits for a response. However, the information will also be incomplete.	The command SET NODE/ROUTER_RESPONSE_TIMEOUT determines the timeout, where the default is 30 seconds. If you determine that the routers need more time to respond, increase the timeout to a value that gives all routers enough time to respond.
Improperly Formatted Data	Each router responds with data in a certain format. If the data is not formatted correctly, the node will be unable to parse it and extract the information, and the information will be incomplete.	This error most likely indicates that there is a problem on the network that is mangling the network packets. In that case, you must resolve the network issue to ensure complete data. If you are sure the network is operating correctly, you may need to contact the appropriate RTR support personnel for a resolution.
Internal Error	An internal error may be temporary, and so retrying your request may resolve the problem.	If the problem persists, contact the appropriate RTR support personnel for a resolution.

1.4 Command Line Interface (CLI)

You access the RTR CLI by entering RTR at the operating system prompt. You can enter commands on the same line as the RTR verb or you can enter several commands at the RTR prompt. For an illustration of the RTR CLI, see the *HP Reliable Transaction Router Getting Started* manual. The following example shows a one-line command:

```
% rtr command
```

This example shows a multiple-line set of commands:

```
% rtr
(C) 1994, 2005 Hewlett-Packard Development Company, L.P.
RTR> start rtr
%RTR-I-STACOMSRV, starting command server on NODEA in group "Testing"
RTR> create journal
%RTR-W-JOUALREXI, journal already created
```

The RTR CLI accepts commands that you type and can process procedures consisting of RTR commands.

Most RTR commands accept qualifiers, indicated by the forward slash (/) character. For example, many RTR commands accept the /OUTPUT qualifier; it directs the output from the command to a file.

The forward slash (/) character may also appear in the file names of some operating systems; such file names must be enclosed in quotation marks to ensure that RTR does not interpret the file name as a command qualifier.

When RTR commands are entered on a single line, you may need to use extra quotation marks, depending on the operating system in use. For example, when you enter the following command at the RTR prompt, use the following format:

```
RTR> call rtr_send_to_server "Message text"/channel=c
```

If you enter the above command from the operating system command line, you must use additional quotation marks. For example,

- On UNIX and Linux:

```
% rtr call rtr_send_to_server "'Message text'"/channel=c
```

- On OpenVMS:

```
$ rtr call rtr_send_to_server ""'Message text'"/channel=c
```

- On Windows:

```
C:\ rtr call rtr_send_to_server ""'Message text'"/channel=c
```

Introduction

1.4 Command Line Interface (CLI)

or

```
C:\ rtr call rtr_send_to_server \"Message text\"/channel=c
```

For RTR on Windows

When executing commands from the RTR command line (CLI), if the process that opens a channel goes away, the PID associated with that channel also goes away due to the way Windows identifies the requester. This can cause invalid channel arguments, but is normal behavior in a test or experimental environment using the CLI.

1.4.1 Online Help for the RTR CLI

You can get information about the RTR CLI by using the HELP command. The following command displays a list of help topics on your terminal.

```
% rtr help
```

If you require additional information, you can enter the topic directly on the same line.

```
% rtr help show
```

You can also use the HELP ERRORS command to further explain errors returned by RTR.

```
% rtr help errors error-identification
```

where *error-identification* identifies the returned error.

In the following example, a message is received with the identifier RTRALRSTA and a brief explanation. Further explanation can be obtained by using the help errors rtralrsta command.

```
% rtr
RTR> start rtr
%RTR-F-RTRALRSTA, rtr already started
RTR> help errors rtralrsta
```

Errors

RTRALRSTA

RTR already started

Explanation: RTR was already running when the "START RTR" command was executed. This error message is displayed by the RTR utility.

RTR>

1.5 Command Procedures

RTR commands can be written in a command file, script, .cmd or .bat file and then executed as a procedure using the RTR EXECUTE filespec or @filespec commands.

For example, on any UNIX-based or Windows system:

```
% rtr execute createfacil
```

or:

```
% rtr @createfacil
```

or at the RTR prompt:

```
% rtr
RTR> execute createfacil
```

or on an OpenVMS system:

```
RTR> @createfacil
```

Batch Procedure/Command File Restriction

The last line of a batch procedure or command file must explicitly end with <CRLF> added by pressing the Enter/Return key when creating the procedure. Without the explicit <CRLF>, RTR ignores the line. The workaround is to add a comment to the end of the file or to explicitly add <CRLF> to the end of the last line of the batch procedure.

Introduction

1.6 Remote Commands

1.6 Remote Commands

Most RTR commands can be issued either locally (the default) or on one or more remote nodes.

If you use the TCP/IP protocol to activate RTR's remote command capability, you must configure RSHHELL for your users. You must start and configure daemons to accept remote commands and authorize users. If you use DECnet, you must have proxy access which involves an authorization step on target systems and remote task objects must be enabled. Refer to your operating system documentation for more information.

To specify remote node names explicitly, use a command such as:

```
RTR> command/node=node-list
```

For example, this command starts RTR on the nodes, nodeA, nodeB, and nodeC:

```
RTR> start rtr/node=(nodeA,nodeB,nodeC)
```

To specify remote nodes implicitly (for a command to be executed on every node in a recognized cluster), use a command of the following form:

```
RTR> command/cluster
```

Remote commands in group mode fail unless groups are the same on the local and the remote nodes. If you are using group mode, the first command or remote command in any sequence should be SET MODE /GROUP.

Cluster Qualifiers

The /CLUSTER and /NOCLUSTER command qualifiers are used in operating systems such as OpenVMS and TRU64 Unix that fully support clustering and that support the remote command capability. Using the /CLUSTER qualifier on systems that do not support clustering causes the relevant command to be executed on the local node only.

To enable the remote command capability in RTR, use the following:

On this operating system:	Complete this setup:
HP-UX	Install <code>remsh</code> server and client, then set up access control between the appropriate users.
Linux	Install <code>rsh</code> server and client, then set up access control between the appropriate users.
OpenVMS	If using DECnet, set up proxies; if using TCP/IP, also set up an <code>rsh</code> client.
Windows	Install <code>rsh</code> server and client, then set up access control between the appropriate users.

To execute several commands remotely on several nodes but minimize typing, use the `SET ENVIRONMENT` command.

The following example stops RTR from taking transactions on the two specified nodes, `nodeA` and `nodeC`. The RTRACP will continue to run.

```
% RTR
RTR> set environment/node=(nodeA, nodeC)
RTR> stop rtr
```

For more details on the above commands, see the description of the `SET ENVIRONMENT` command in the reference section of this manual.

RTR command and `http` servers started during an interactive Windows session do not survive a user logout of that session. After user logout from an interactive Windows session, the machine is no longer accessible to the RTR web browser.

To avoid this, enable remote shell (`rsh`) access to the Windows system; the `http` server can then be started with a remote RTR command directed at the system of interest. Windows `rsh` functionality is available from third parties, and with the Microsoft Windows Server Resource kit.

Starting and Setting Up RTR

This chapter describes how to configure and start an RTR environment. Recovery journals, router load balancing and callout servers are also discussed.

2.1 Introduction

Before RTR applications can run, RTR must be started and the application's facility must be defined on each node of the application's environment. This is done by issuing the `START RTR` and `CREATE FACILITY` commands on each participating node.

There are several ways to accomplish this:

- Log in to each node in turn and issue the commands interactively.
- Log in to one node and use the remote command capability to configure all the nodes from one session, where your system supports this capability. See Section 1.6 for more information.
- Include the necessary commands in a startup script or command file on each node so the commands are automatically executed when the nodes are booted.

Once RTR is started, you can use the RTR web interface or the RTR CLI to create facilities and partitions.

The first two methods are more suited to a development or test environment, while the last method is more suited to a production environment.

In the RTR configuration:

- Start RTR
- Create a journal
- Create facilities
- Create partitions

Starting and Setting Up RTR

2.1 Introduction

- Use an application or the RTR CLI to send and receive transaction messages

For more information on startup scripts, see the chapter for the relevant operating system in the *HP Reliable Transaction Router Installation Guide*.

The remaining sections contain examples of the commands used to start and configure RTR. Section 9.2 gives syntax details of the RTR commands.

2.2 Setting Up—An Example

The following example assumes that RTR has been started on the eight-node system shown in Figure 2–1.

Figure 2–1 RTR Configuration

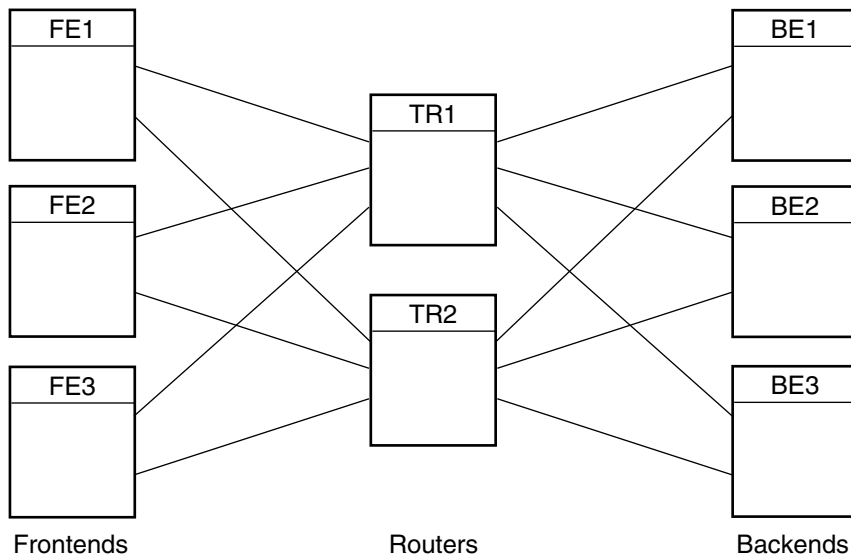

VM-0849A-AI

In Figure 2–1, the application client processes run on the frontend nodes FE1, FE2 and FE3, and the server application processes run on the backend nodes BE1, BE2 and BE3. Nodes TR1 and TR2 are routers and have no application processes running on them. Figure 2–1 shows all possible connections, but a frontend connects to only one router at a time.

2.2.1 Starting RTR and Creating a Facility

Example 2–1 shows the START RTR commands that must be issued on each node to start this configuration. Commands are issued first on node FE1, then on FE2, and on FE3 for frontends followed by TR1 and TR2 for routers, and finally BE1, BE2, and BE3 for backends.

Example 2–1 Local Configuration of Each Node

```
% rtr ❶  
RTR> start rtr ❷  
  
RTR> create facility funds_transfer/frontend=(FE1,FE2,FE3) -  
_RTR> /router=(TR1, TR2) - ❸  
_RTR> /backend=(BE1, BE2, BE3)
```

- ❶ Starts the RTR CLI.
- ❷ Starts the RTRACP process.
- ❸ This command issued on each node in the configuration creates a facility in which nodes FE1, FE2, and FE3 are frontends, nodes TR1 and TR2 are routers, and nodes BE1, BE2, and BE3 are backends. (The hyphen (-) at the end of command lines is a continuation character that retains the context for the command until it is ended with a carriage return.)

The commands shown in Example 2–1 could also be included in each node's startup script or put in a command procedure used to start the application.

The network must be started

RTR cannot start until after the network has started.

Frontends and backends need to know about the routers to which they are connected, but frontends don't need to know about backends or other frontends, nor backends about frontends or other backends. In creating facilities, RTR ignores superfluous node names so that you can use the same CREATE FACILITY command on every node in an RTR configuration. This helps to simplify maintenance of startup command procedures.

For example, the same RTR CREATE FACILITY command shown in Example 2–2 can be issued on all nodes in the configuration. When issued on FE1, RTR ignores the list of backends because nodes only need to know about the nodes in the neighboring layers of the configuration, thus FE1 does not need to know about BE1.

Starting and Setting Up RTR

2.2 Setting Up—An Example

Example 2–2 illustrates how to use RTR remote commands to start the same configuration. The SET ENVIRONMENT command is used to send commands to several RTR nodes.

Example 2–2 Remote Setup from One Node

```
% rtr
RTR> set environment/node=(FE1, FE2, FE3, TR1, TR2, BE1, BR2, BR3)
RTR> start rtr
RTR> create facility funds_transfer/frontend=(FE1, FE2, FE3) -
_RTR>                               /router=(TR1, TR2) -
_RTR>                               /backend=(BE1, BE2, BE3)
```

This enters the commands on every node in the configuration. You must have an account with the necessary privileges on any node where the command is to execute.

Use the SHOW RTR command to find out if RTR has been started on a particular node.

Use the SHOW FACILITY command to see which facilities have been created and use the SHOW LINK command to see how they are configured. The full syntax of these commands is given in Chapter 9. You can view the effect of these commands with the RTR web browser.

Dynamic Addressing on Windows

For operator convenience, nodes running Windows with dynamic addressing should be registered in DNS. If this is not desirable, such nodes can be specified in the CREATE FACILITY command by using the current IP address that may need to be changed after a reboot. For example, the following command could be executed on an OpenVMS system to include a Windows frontend that uses dynamic addressing, where 1x.2x.xx.xxx represents the IP address of the frontend:

```
RTR> CREATE FAC OSIRIS/backend=NODEA/router=NODEA/frontend=1x.2x.xx.xxx
%RTR-S-FACCREATE, facility OSIRIS created
RTR> SHOW FACILITY...
```

2.3 Creating a Recovery Journal

Every RTR backend must have a journal; an application with a callout server (which runs on the router) should have a journal on the router. The journal is used by the backend that must have physical access to the journal.

RTR writes data to journal files to be able to recover (that is, replay) partially executed transactions after a backend node failure. The journal file must be placed on a disk that is visible to nodes running RTR. If you locate your journal on a non-local disk, and the node accessing that disk goes down, RTR cannot access transactions in that journal until the failed node comes back up.

The amount of space required for the journal depends upon the:

- Size of the messages in a transaction
- Number of messages in the transaction
- Rate of generation of transactions
- Maximum time a shadow site can be out of commission

To size a journal, use the following rough estimates as guidelines:

- Allow 140 bytes per inbound message (C++ API `SendMessage` or C API `rtr_send_to_server()` call).
- Allow 140 bytes per transaction (C++ API `AcceptTransaction` or C API `rtr_accept_tx()` call).
- Allow 512 bytes per journal file for internal header information.
- Add an amount to accommodate your application message size.

Use of large transactions generally causes poor performance, not only for initial processing and recording in the database, but also during recovery. Large transactions fill up the RTR journal more quickly than small ones.

The `/MAXIMUM_BLOCKS` qualifier on the `CREATE JOURNAL` command controls how large a journal may become. The `/MAXIMUM_BLOCKS` qualifier defines the maximum number of blocks which the journal is allowed to occupy on any one disk. RTR does not check if this amount of space is actually available, as the disk space specified by `/MAXIMUM_BLOCKS` is used only on demand by RTR when insufficient space is available in the space allocated by the `/BLOCKS` qualifier.

The number of blocks specified by the `/BLOCKS` qualifier specifies the maximum size of the journal that RTR attempts to use. The actual number of blocks used may vary, depending upon the load on RTR.

Starting and Setting Up RTR

2.3 Creating a Recovery Journal

The command `MODIFY JOURNAL` also accepts the `/BLOCKS` and `/MAXIMUM_BLOCKS` qualifiers.

Journal file extension occurs on demand when RTR detects that a “write to journal” would otherwise fail due to lack of space. Journal file truncation takes place periodically when enough free blocks are detected.

Refer to `MODIFY JOURNAL` for the syntax of the `MODIFY JOURNAL` command.

```
RTR> show journal/files/full
```

```
RTR journal:-
```

```
Disk: /dev/rz3a      Blocks:    2500 Allocated: 1253 Maximum: 3500  
File: //rtrjnl/anders/BRONZE.J00
```

```
RTR>
```

See Section 5.3, RTR Journal System, for information on how to calculate the size of the journal. Preferably, create your RTR journal on a disk in a recognized cluster.

To improve performance, the journal may be striped across several disks. Specify the location and size of the journal using the `CREATE JOURNAL` command.

Issue the `CREATE JOURNAL` command on each node where an application server will run, that is, on each backend node and on any router nodes where you intend to run router callout servers. It must be issued after installing RTR and before creating any facilities. It may be issued again later to alter the size or location of the journal to improve performance. Use the `MODIFY JOURNAL` command to adjust journal sizes.

Caution for Journals

The `CREATE JOURNAL/SUPERSEDE` command **deletes** the contents of any existing journal files. If transaction recovery is required, **DO NOT ISSUE** this command after a failure.

To make a copy of a journal file, stop RTR and copy the file to a directory outside the `rtrjnl` directory or RTR will issue a spurious journal file message (`% RTR-F-SPUJOUFIL`) when it sees a journal file it did not create.

2.3.1 Maximum Journal Size

The current maxima for the size of a journal are:

Number of 512-bytes blocks per disk: 524288

(This is `max_segments_per_disk * disk_blocks_per_segment`, or 16384 bytes times 32.)

Number of disks per journal: 16.

2.4 Fast Shadow Recovery Journaling

With fast shadow recovery, a node becomes primary active or secondary active as soon as it has copied all the transactions from the remembering node. Whether it becomes primary or secondary depends on its priority (established with the `SET PARTITION/PRIORITY` command). However, a large backlog of unprocessed transactions could cause what looks like a dual-site outage if a node immediately becomes primary active, because it must process the backlog before processing new transactions. Thus RTR ensures that a node processing a fast-recovery backlog becomes secondary active until it has caught up with the primary.

Only when it has caught up will it change to primary active state. `MONITOR QUEUES` includes the delay, in seconds, between when transactions arrive on a backend and when they are processed by a server application.

2.5 Changing Membership of a Facility

Using `TRIM FACILITY`

Use the `TRIM FACILITY` command to change RTR facility membership.

Note

The RTR facility defines the nodes used by an application and the roles (frontend, router, backend) they may assume. You do not need to change facility definitions in the event of node or link failures.

When using `EXTEND FACILITY` and `TRIM FACILITY` commands, make sure that the command is issued on all nodes that are affected. That is, all backend nodes must be informed when router configurations are changed and all router nodes must be informed when backend or frontend configurations are changed. For use of anonymous clients, see the description in the `CREATE FACILITY` command. In Figure 2–1, assume that the FE3 node is being removed from the funds transfer facility. Since FE3 is a frontend for this facility, only the routers (TR1 and TR2) need be reconfigured.

Starting and Setting Up RTR

2.5 Changing Membership of a Facility

Example 2–3 shows the commands necessary to achieve this reconfiguration.

Example 2–3 Reconfiguration Using TRIM FACILITY

```
% rtr
RTR> set environment/node=FE3 ❶
%RTR-S-COMARESEN, commands sent by default to node FE3
RTR> delete facility_funds_transfer ❷
%RTR-S-FACDELETE, facility_funds_transfer deleted
RTR> stop rtr/node=FE3 ❸
%RTR-S-RTRSTOP, RTR stopped on node FE3
RTR> set environment/node=(TR1,TR2) ❹
%RTR-S-COMARESEN, commands sent by default to node TR1
%RTR-S-COMARESEN, commands sent by default to node TR2
RTR> trim facility_funds_transfer/frontend=FE3 ❺
%RTR-S-FACTRIMMED, facility_funds_transfer trimmed
-----TR1-----
%RTR-S-FACTRIMMED, facility_funds_transfer trimmed
-----TR2-----
RTR>
```

- ❶ Subsequent commands are executed on node FE3.
- ❷ The facility is deleted on node FE3.
- ❸ RTR is stopped on node FE3, the node being excluded from the network. To prevent transactions from being interrupted or aborted, application processes should be stopped in an orderly manner before issuing the STOP RTR command. Alternatively, a STOP RTR/ABORT command will force application processes using RTR to exit, aborting or interrupting any outstanding transactions. Active transactions will be sent to an existing shadow or standby node.
- ❹ Subsequent commands are executed on nodes TR1 and TR2.
- ❺ Node FE3 is removed from the facilities defined on nodes TR1 and TR2.

Using EXTEND FACILITY

In the example in Figure 2–1, assume that a new router node TR3 and new frontend FE4 are being added to the facility_funds_transfer. The extended configuration is shown in Figure 2–2. This diagram shows the possible frontend to router connections. The frontend connects to only one router at a time.

Figure 2–2 Extend Configuration

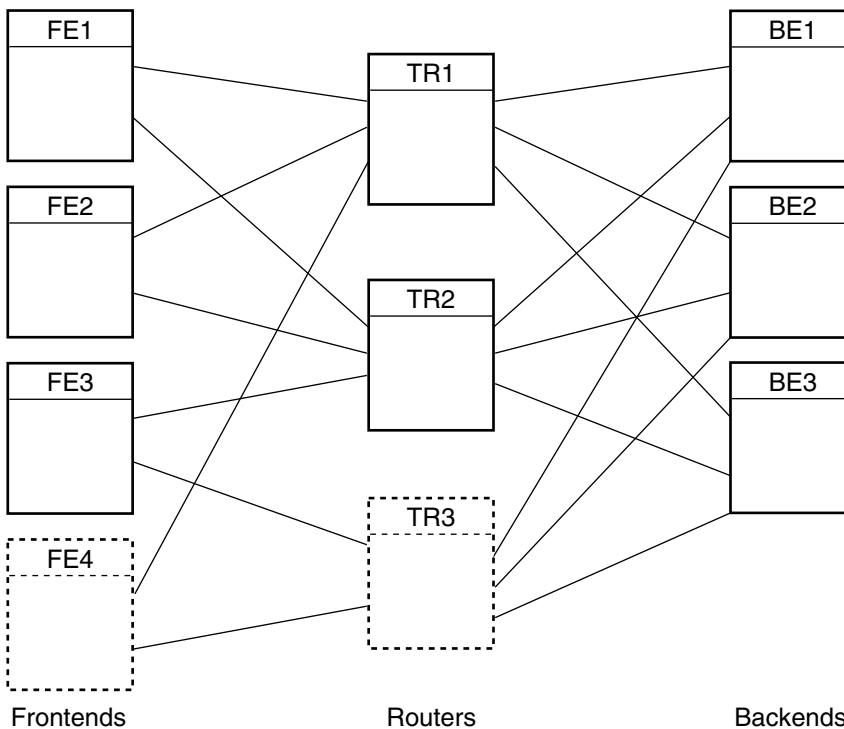

VM-0850A-AI

All backend nodes must be informed when router configurations are changed. Because TR3 will be a router for the FE3 and FE4 frontends, these nodes must also be informed of its presence. Likewise, TR3 must be informed about FE3 and FE4, and all BEs must be informed of the new TR3.

Roles in EXTEND FACILITY are Additive

EXTEND FACILITY commands are additive; roles are added, never removed. To remove a role, use the TRIM FACILITY command.

Example 2–4 shows the EXTEND FACILITY command used for this reconfiguration.

Starting and Setting Up RTR

2.5 Changing Membership of a Facility

Example 2-4 Reconfiguration Using EXTEND FACILITY

```
% RTR
RTR> sho fac ❶
-----BE1-----
Facilities on node BE1 in group "user" at Wed Sep 25 13:53:03 2002
Facility                Frontend  Router  Backend
funds_transfer          no       no      yes
-----BE2-----
Facilities on node BE2 in group "user" at Wed Sep 25 13:53:03 2002
Facility                Frontend  Router  Backend
funds_transfer          no       no      yes
-----BE3-----
Facilities on node BE3 in group "user" at Wed Sep 25 13:53:03 2002
Facility                Frontend  Router  Backend
funds_transfer          no       no      yes
-----TR1-----
Facilities on node TR1 in group "user" at Wed Sep 25 13:53:03 2002
Facility                Frontend  Router  Backend
funds_transfer          no       yes     no
-----TR2-----
Facilities on node TR2 in group "user" at Wed Sep 25 13:53:03 2002
Facility                Frontend  Router  Backend
funds_transfer          no       yes     no
-----FE1-----
Facilities on node FE1 in group "user" at Wed Sep 25 13:53:03 2002
Facility                Frontend  Router  Backend
funds_transfer          yes      no      no
-----FE2-----
Facilities on node FE2 in group "user" at Wed Sep 25 13:53:03 2002
Facility                Frontend  Router  Backend
funds_transfer          yes      no      no
-----FE3-----
Facilities on node FE3 in group "user" at Wed Sep 25 13:53:03 2002
```

(continued on next page)

Starting and Setting Up RTR 2.5 Changing Membership of a Facility

Example 2-4 (Cont.) Reconfiguration Using EXTEND FACILITY

Facility	Frontend	Router	Backend
funds_transfer	yes	no	no

```
RTR> start rtr /node=(TR3,FE4) ②
RTR> set environment/node= - ③
  _RTR> (FE1,FE2,FE3,TR1,TR2,BE1,BE2,BE3,TR3,FE4)
%RTR-S-COMARESEN, commands sent by default to node FE1
%RTR-S-COMARESEN, commands sent by default to node FE2
%RTR-S-COMARESEN, commands sent by default to node FE3
%RTR-S-COMARESEN, commands sent by default to node TR1
%RTR-S-COMARESEN, commands sent by default to node TR2
%RTR-S-COMARESEN, commands sent by default to node BE1
%RTR-S-COMARESEN, commands sent by default to node BE2
%RTR-S-COMARESEN, commands sent by default to node BE3
%RTR-S-COMARESEN, commands sent by default to node TR3
%RTR-S-COMARESEN, commands sent by default to node FE4

RTR> extend facility funds_transfer - ④
  _RTR> /router=TR3/frontend=(FE3,FE4) -
  _RTR> /backend=(BE1,BE2,BE3)
.
.
.
-----TR3-----
%RTR-S-FACEXTENDED, facility funds_transfer extended
-----FE4-----
%RTR-S-FACEXTENDED, facility funds_transfer extended
-----

RTR> extend facility funds_transfer - ⑤
  _RTR> /router=TR1/frontend=(FE4)
.
.
.
RTR> sho fac funds_transfer
-----TR3-----
Facilities on node TR3 in group "user" at Wed Sep 25 13:52:16 2002
Facility          Frontend  Router  Backend
funds_transfer    no       yes     no
-----FE4-----
Facilities on node FE4 in group "user" at Wed Sep 25 14:04:49 2002
```

(continued on next page)

Starting and Setting Up RTR

2.5 Changing Membership of a Facility

Example 2–4 (Cont.) Reconfiguration Using EXTEND FACILITY

Facility	Frontend	Router	Backend
funds_transfer	yes	no	no

- 1 Shows the initial configuration before extending the facility.
- 2 These are new nodes, so RTR must be started on them.
- 3 The SET ENVIRONMENT command sends the command to all nodes in the facility, including the new nodes.
- 4 The EXTEND FACILITY command defines the new router TR3 and the new frontend FE4. Because the new router is also connected to the existing frontend FE3, this node must also be specified as a frontend. The new router TR3 is told about all backends with the /BACKEND qualifier. Note that the EXTEND FACILITY command has been used to create new definitions on TR3 and FE4, and extend the definitions on BE1, BE2 and BE3.
- 5 The EXTEND FACILITY command is used to extend the definitions on TR1 and FE4 to give FE4 a second router link.

2.6 Setting Up Callout Servers

Callout servers are checking or verification applications running on a router or backend; they receive a copy of every transaction passing through the node where the callout server is running.

Like any other server, callout servers can abort any transaction in which they participate. Callout servers are typically used to provide an additional security or checking service; transactions can be inspected by the callout server and aborted if they fail to meet user-defined criteria.

Callout servers require that a journal be created on the node where the server runs. For a backend callout server, there would already be a journal because backends require journals, but if the callout server is running on a router, a journal is required on the router node.

Assume that callout servers are to run on the router nodes (TR1 and TR2) in the configuration shown in Figure 2–1. Example 2–5 shows the commands needed to set up callout servers on the routers.

Example 2–5 Configuration of Callout Servers

```
% rtr
RTR> set environment/node= -
_RTR> (FE1,FE2,FE3,TR1,TR2,BE1,BE2,BE3)

RTR> start rtr

RTR> create facility funds_transfer/frontend=(FE1,FE2,FE3) -
_RTR> /router=(TR1,TR2) -
_RTR> /backend=(BE1,BE2,BE3) -
_RTR> /call_out=router
```

Changing Facilities

Before changing a facility from one with callout servers to one without callout servers, verify that all transactions in the facility are completely resolved by keyrange and callout server. (You can use `SHOW TRANSACTION/FULL` to view the state of all transactions.) Otherwise, after changing your facility, transactions may remain in the system as in recovery until either the facility is changed to allow their recovery or the journal is recreated.

2.7 Router Considerations

To avoid problems with quorum resolution, design your configuration with an odd number of routers. This ensures that quorum can be achieved.

To improve failover, place your routers on separate nodes from your backends. This way, failure of one node does not take out both the router and the backend.

If your application requires frontend failover when a router fails, frontends must be on separate nodes from the routers, but frontends and routers must be in the same facility. For a frontend to fail over, there must be more than one router in the facility.

To identify a node used only for quorum resolution, define the node as a router or as a router and frontend. On this node, define all backends in the facility, but no other frontends.

With a widely dispersed set of nodes (such as nodes distributed across an entire country), use local routers to deal with local frontends. This can be more efficient than having many dispersed frontends connecting to a small number of distant routers. However, in some configurations such as those without

Starting and Setting Up RTR

2.7 Router Considerations

long network links, it may be more effective to place routers near backends. For more information on configuration considerations, see the *HP Reliable Transaction Router Application Design Guide*.

2.8 Router Load Balancing

Router load balancing, or intelligent reconnection of frontends to a router, enables a frontend to select a preferred router, the router that is least loaded. Load balancing is coordinated by backends.

You use the `/BALANCE` qualifier on the `CREATE FACILITY` and `SET FACILITY` commands to control load balancing. (The RTR Version 2 implementation of load balancing treated all routers as equal which might cause reconnection timeouts in geographically distant routers.)

When used with `CREATE FACILITY`, the `/BALANCE` qualifier enables load balancing for frontend-to-router connections across the facility. Use `SET FACILITY/NOBALANCE` and `/BALANCE` to switch load balancing off and on.

The default behavior (`/NOBALANCE`) connects a frontend to the *preferred router*. Preferred routers are selected in the order specified in the `/ROUTER=(tr1,tr2,tr3,...)` qualifier used with the `CREATE FACILITY` command. If the `/ALL_ROLES` qualifier is also used, the nodes specified have lower priority than the nodes specified by the `/ROUTER` qualifier. RTR automatic failback ensures that the frontend will reconnect to the first router in the specified order when it becomes available. Manual balancing can be attained by specifying different router orders across frontends.

When the `/BALANCE` qualifier is used, the list of routers specified in the router list is randomized, making the preferred router a random selection within the list. Randomness assures that there will be a balance of load in a configuration with a large number of frontends. RTR's process for automatic failback will maintain the load distribution on the routers. Failback is controlled so as not to overload configurations with a small number of routers.

For example, assume the following command is issued from a frontend:

```
RTR CREATE FACILITY test/FRONTEND=Z/ROUTER=(A,B,C)
```

The frontend attempts to select a router based on the priority list A, B, C, with A being the preferred router. If the `/BALANCE` qualifier is added to the end of this command, the preferred router is randomly selected from the three nodes. This random list exists for the duration of the facility. If a facility is stopped, a new random list is made when the facility is recreated, unless a router does not have quorum (sufficient access to backend systems). A router without quorum will no longer accept connections from frontend systems until it has again achieved quorum.

Consider the following points when using load balancing:

- Frontends connect to a single router at a time, per facility
- When several routers are configured on the frontend, the specified list in the `CREATE FACILITY` command designates the preferred search order unless the `/BALANCE` qualifier is used.
- Balancing can be individually enabled or disabled on the frontend nodes.
- Balancing is dynamic. The loss or addition of a router node causes the frontend nodes to redistribute their connections.
- Use `/BALANCE` for frontends to specify router random selection. See `CREATE FACILITY` and `SET FACILITY` for more information on the `/BALANCE` qualifier.

The commands to set, show or monitor load balancing are:

- `CREATE FACILITY/BALANCE`
 - Enables load balancing on the node where it is issued
 - Significant only for frontend nodes to specify router random selection
 - Disabled, by default
- `SET FACILITY/[NO]BALANCE`
 - Toggles the balance attribute on the node where it is issued
- `SHOW FACILITY/CONFIGURATION`
 - Shows, among other things, whether load balancing has been set
- `SHOW FACILITY/LINK`
 - Shows facility name
 - Shows links to nodes with status of frontends, routers, and backends, whether routers and backends are quorate and current, and whether the backend is the coordinator
 - Helps troubleshoot link problems
- `SHOW FACILITY/BALANCE`
 - Shows the number of frontends connected and allowed, load coordinator status, number of quorate routers, total frontends, and current credit
 - Helps troubleshoot frontend connection problems

Starting and Setting Up RTR

2.8 Router Load Balancing

- MONITOR FLOW
 - Shows available credits and data rates for role directions
- MONITOR TRAFFIC
 - Shows congestion on RTR links.

2.9 Concurrent Processes

Adding concurrent processes (concurrency) for server application processes usually increases performance. Concurrency permits multiple server channels to be connected to an instance of a partition.

Concurrency should be added during the testing phase, before an application goes into production to verify that performance does increase. For example, if multiple servers require a lock to the same part of the database, transaction throughput could decrease rather than increase with concurrent servers. For transaction throughput to increase in such a case, transactions must lock independent parts of the database.

Consider the following factors when adding concurrency:

- Number of disks used for the RTR journal and the database
- Disk I/O
- Memory capacity
- CPU speed
- Number of CPUs
- Network I/O
- Network reliability, for example, insufficient capacity of hardware
- Database access and contention
- Application performance
 - Multiple threads
 - Multiple channels
 - Multiple partitions

Refer to the *HP Reliable Transaction Router Application Design Guide* for more information on application performance tuning.

2.10 RTR Privileges

RTR supports two levels of rights or privileges:

- `rtroper` and `rtrinfo` on UNIX platforms
- `RTR$OPERATOR` and `RTR$INFO` on OpenVMS platforms
- `RtrOperator` and `RtrInfo` on Windows platforms

In general, `rtroper` or `RTR$OPERATOR` is required to issue any command that affects the running of the system, and `rtrinfo` or `RTR$INFO` is required for using monitor and display commands.

Setting RTR Privileges on UNIX Systems

On UNIX machines, RTR privileges are determined by the user ID and group membership. For RTR users and operators, create the group `rtroper` and add RTR operators and users as appropriate.

The root user has all privileges needed to run RTR. Users in the group `rtroper` also have all privileges with respect to RTR, but may not have sufficient privileges to access resources used by RTR, such as shared memory or access to RTR files.

The `rtrinfo` group is used only to allow applications to call `rtr_request_info()`. For other users, create the groups `rtroper` and `rtrinfo`. Users who do not fall into the above categories, but are members of the `rtrinfo` group, can use only the RTR commands that display information (`SHOW`, `MONITOR`, `CALL RTR_REQUEST_INFO`, etc.). `RTRINFO` privilege (or being a member of `rtrinfo` group) itself is not sufficient for the user to execute `SHOW` and `MONITOR` commands.

Depending on your UNIX system, see the `addgroup`, `groupadd` or `mkgroup` commands or the System Administration documentation for details on how to add new groups to your system.

If the groups `rtroper` and `rtrinfo` are not defined, all users automatically belong to them. This means that there is no system management required for systems that do not need privilege checking.

Starting and Setting Up RTR

2.10 RTR Privileges

Requirements for Application Permissions

If the RTR executable is modified after installation to no longer be suid root or the mode of the /rtr directory is changed, an application process (for example a client) can encounter a fatal error (Unable to locate a socket) when the client process finds it cannot create an rtr_ipc_sock_* file for the process ID (pid) in the /rtr directory.

To avoid this, ensure that application processes run with user and group IDs that have access permission to create and remove files in this directory.

Setting RTR Privileges on OpenVMS Systems

Use the AUTHORIZE utility to create the Rights Identifiers RTR\$OPERATOR and RTR\$INFO if they do not already exist on your system, and assign them to users as appropriate. The RTR System Manager must have the RTR\$OPERATOR identifier or the OPER privilege.

Setting RTR Privileges on Windows Systems

Administrator privileges are needed for RtrOperator rights by the RTR System Manager.

2.11 RTRACP Virtual Memory Sizing for all Systems

Basic memory requirements of an unconfigured RTR Application Control Process (RTRACP) on all supported operating systems is approximately 5.8 Mbytes. Additional memory may be required depending on the operating system environment being used by the RTRACP. While there is no penalty for allocating more virtual memory than is used, applications may fail if too little memory is allocated.

RTR contains a low memory check. If the RTRACP detects that it is critically low on free memory, it may reject new and uncommitted transactions to preserve its limited resources. Committed transactions will not be aborted. The RTRACP will also discard any broadcasts that arrive after it is low on memory. Versions of RTR prior to V4.2 would not detect that it was low on memory and RTR could crash as a result; now the crash is avoided.

The client and server receive an rtr_mt_rejected message if a transaction is aborted due to low memory. If the frontend is low on memory, the associated status is FERJECTLOWMEM; if the backend is low on memory, the associated status is BERJECTLOWMEM. A log entry, RTR_E_ACPLOWMEMORY, is written when the RTRACP is critically low on

Starting and Setting Up RTR

2.11 RTRACP Virtual Memory Sizing for all Systems

memory. When the RTRACP regains access to sufficient memory, a log entry RTR-I-ACPSUFMEMORY is written.

The following allowances for additional virtual memory should be made:

Table 2–1 Virtual Memory Allowances

For each	Add an additional
Link	202 Kbytes
Facility	13 Kbytes plus 80 bytes for each link in the facility
Client or server application process	190 Kbytes for the first channel
Additional application channel	1350 bytes

You must also prepare for the number of active transactions in the system. Unless the client applications are programmed to initiate multiple concurrent transactions (multi-threading), this number cannot exceed the total number of client channels in the system. This should be verified with the application provider.

It is also necessary to determine the size of the transaction messages in use:

- For each frontend:
 - Add 1 Kbyte per active transaction
 - Add 250 bytes per message per transaction
 - Add the size of all messages
 - Add the size of channel queues
- For each transaction router:
 - Allow 1 Kbyte for each active transaction
- For each back end:
 - Allow 1 Kbyte per active transaction
 - Allow 50 bytes for each message of a transaction
 - Add the size of all replies
 - Add the size of channel queues

Starting and Setting Up RTR

2.11 RTRACP Virtual Memory Sizing for all Systems

The RTRACP virtual memory sizing requirements for replies are:

- 128 bytes per reply plus
- the lesser of:
 - size of the replies plus 120 times the number of replies
 - 10 Mbytes

Thus if you want to send a million replies, make provision for a virtual address space of 138 Mbytes.

The total of all the contributions listed will provide an estimate of the virtual memory requirements of the RTRACP. A generous additional safety factor should be applied to the total virtual memory sizing requirement.

Resource Sizing for OpenVMS

On OpenVMS, it is better to grant the RTRACP resource limits exceeding its real requirements than to risk loss of service in a production environment as a result of insufficient resource allocation. The total result should be divided by the virtual memory size in pages to obtain the final virtual memory requirement. Process memory and page file quotas should be set to accommodate at least this much memory.

Resource Sizing for UNIX and Windows

On other operating systems, just make sure your machine has the physical memory and the disk space for a swap file.

2.11.1 OpenVMS Virtual Memory Sizing

On OpenVMS, process quotas are controlled by qualifiers to the START RTR command. START RTR accepts both links and application processes as qualifiers which can be used to specify the expected number of links and application processes in the configuration. The values supplied are used to calculate reasonable and safe minimum values for the following RTRACP process quotas:

- ASTLM
- BIOLM
- DIOLM
- FILLM
- PGFLQUO

Starting and Setting Up RTR

2.11 RTRACP Virtual Memory Sizing for all Systems

You can now include in the calculation of the OpenVMS page file quota (PGFLQUO), the effects of the variables RTR_MAX_CHANNEL_WAITQ_BYTES and RTR_EVENT_CHANNEL_LIMIT_PC. With these variables, the calculation assumes an average of five channels per application process, and increases the page file quota of the RTR ACP process substantially. If this average of five channels inadequately describes your configuration, specify a correspondingly higher number of processes when starting RTR.

Both the /LINKS and /PROCESSES qualifiers have high default values.

The default value for /LINKS is 512. This value is high but is chosen to protect RTR routers against a failover where the number of frontends is large and the number of surviving routers is small. The maximum value for /LINKS is 1200.

The default value for /PROCESSES is 64. This value is large for frontend and router nodes but is sized for backends hosting applications. Backends with complex applications may have to set this value higher.

The maximum value for /PROCESSES is the OpenVMS allowed maximum. Warning messages are generated if the requested (or default) memory quotas conflict with the system-wide WSMAX parameter, or if the calculated or specified page file quota is greater than the remaining free page file space.

The default values for /LINKS and /PROCESSES require a large page file. RTR issues a warning if insufficient free space remains in the page file to accommodate RTR, so choose values appropriate for your configuration.

The /LINKS and /PROCESSES qualifiers do not take into account memory requirements for transactions. If an application passes a large amount of data from client to server or vice-versa, this should be included in the sizing calculations. For further information on the START RTR qualifiers, see the START RTR command in the Command Reference section.

You may explicitly specify values for the VMS process quotas listed above, but it is an error to specify a value smaller than that calculated by RTR based on the values supplied with /LINKS and /PROCESSES.

Once the process quotas have been determined, RTR makes some additional checks against the system configuration, issuing a warning message if a problem is detected. Currently these warnings do not prevent the ACP from starting. Parameters that are checked include:

- Available space in the system page files
- CHANNELCNT
- MAXPROCESSCNT

Starting and Setting Up RTR

2.11 RTRACP Virtual Memory Sizing for all Systems

- WSMAX

Note

The OpenVMS AUTHORIZE utility does not play a role in the determination of RTRACP quotas. RTR uses AUTHORIZE quotas for the command line interface and communication server, COMSERV. Virtual memory sizing for the RTRACP is determined through the qualifiers of the START RTR command.

2.11.2 UNIX Virtual Memory Sizing

The RTRACP requires the operator to size the process limits for the RTRACP before starting RTR on all platforms. No direct control of the process quotas of the RTRACP is offered for UNIX based platforms. However, log file entries will result if hard limits are less than the preferred values for the RTRACP.

This list shows the minimum limits for the RTRACP on the following UNIX platforms:

- On Linux:
 - 1024 open file descriptors
 - 1048576 Kbytes for virtual memory address space
 - 262144 Kbytes for a single file size
 - 409600 Kbytes for heap data segment sizing
 - 32768 Kbytes for core file size
 - 8192 Kbytes for stack segment size
 - 0 for CPU time

The START RTR qualifiers /LINK and /PROCESSES apply only to the OpenVMS platform. Process quotas on UNIX platforms must be determined through operating system handling of virtual memory sizing.

2.12 RTR Shared Memory Sizing

Each operating system where RTR runs has different requirements for shared memory, a system-wide resource. These requirements are as follows:

On Linux:

To start and operate, RTR allocates a shared memory segment of approximately 160,040 bytes. This portion of memory will be exclusively used for management operations such as establishing connections between a frontend and a router.

In addition to this memory, RTR also uses a shared memory segment of approximately 12,592 bytes for every process including the RTR COMSERV that has opened an RTR channel. This requirement is independent of the number of threads used in the application process.

Often, RTR needs to service multiple client/server applications on a given node. To minimize shared-memory related operations on each client/server application open-channel request, the RTRACP allocates shared memory in large chunks, in amounts that differ on different platforms. These large chunks are later used on demand. Please consult your operating system documentation for more information on various tunable shared memory-related parameters.

For Windows and OpenVMS:

RTR uses a different mechanism on Windows and OpenVMS platforms. For OpenVMS, RTR uses global sections and on Windows, memory-mapped I/O. However, the basic memory requirement of 12,592 bytes for every application process, and 160,040 bytes for management activities, remains the same. Each global section will be able to accommodate process counters belonging to ~32 RTR applications. Any increase in application counters, which happens from release to release, will reduce the number of applications that can be accommodated in a global section.

For more information on limits of memory-mapped I/O and global sections, see the Operating system documentaion.

2.13 Environment Variables Used by RTR

RTR can use several environment variables for specific needs. How you set these depends on your operating system. Use them to do the following:

- tune journal access
- compress reply data
- manage flow control

Starting and Setting Up RTR

2.13 Environment Variables Used by RTR

- establish network transports, frontend notification, best response time, journalling parameters, default node affixes
- restrict incoming connections to a specific network
- ensure that partition instances resume in their prior mode when regaining a connection
- customize break-in detection and evasion
- revert to V3/V4 behavior

You set these environment variables on OpenVMS with ASSIGN or DEFINE. On UNIX the command differs according to the shell. For the c shell (csh), use SETENV; for the bourne shell (sh) or bourne again shell (bash), use SET followed by EXPORT. Other shells may use a different command. On Windows, set the environment variables through the Advanced Properties tab on My Computer. These variables are summarized in Section 2.13.7 and described more fully in the sections that follow.

2.13.1 Environmental Variables for HP-UX and Linux I64 Clusters

In HP-UX and Linux clusters, to configure RTR in ACTIVE/STANDBY mode the following environmental variables must be set:

- **RTR_CLU_MEM_NODES:** This variable enables RTR to recognize the backend nodes of the cluster participating in the ACTIVE/STANDBY mode. For example:
`RTR_CLU_MEM_NODES= "BE1, BE2"`
- **RTR_CLU_LCK_DISK:** This variable enables RTR to maintain "cluster node locks" on a common disk shared in the cluster. All backend nodes in the cluster must use the same disk for maintaining "cluster node locks". For example:
`RTR_CLU_LCK_DISK="/dev/vx/dsk/rtrdata/rtr_files"`
- for HP-UX I64

2.13.2 Tuning for Journal Access in a Cluster

RTR can exhibit several different behaviors for journal locking in a cluster depending on the setting of certain environmental variables. These include, RTR_JNL_RETAIN_SECS to prevent premature journal release, RTR_JNL_RELEASE_SECS to release a journal after a given period of time, RTR_JNL_RETAIN_MODE to define the level of support for journal host resignation, and RTR_JNL_PARTITION_FAILBACK to reset partition priorities from standby to a prior mode.

- **RTR_JNL_RETAIN_SECS:** To prevent premature journal release in an unstable network, a system requires that conditions enabling a node to

Starting and Setting Up RTR

2.13 Environment Variables Used by RTR

resign hosting its journal persist for the length of time (in seconds) specified by this environment variable. If this variable is not specified, RTR assumes the default of 30 seconds. The effective value used by RTR is the greater of the value specified (or the default) and the greatest link-inactivity timeout for all RTR links that communicate with routers.

To display the value of this parameter, use the `SHOW RTR/COUNTER=jam_jnl_retain_secs` command.

- **RTR_JNL_RELEASE_SECS:** Systems requesting that a cluster colleague node give up its journal persist with the request for this number of seconds. After this time period, the request will be dropped and the journal access attempt is allowed to fail. The default value assumed by RTR is three times that in use for the journal retention timer `RTR_JNL_RETAIN_SECS`.
- **RTR_JNL_RETAIN_MODE:** Defines the level of support for the journal host resignation feature. This parameter can be used to resolve a journal access conflict when an RTR backend becomes isolated from the network and blocks access to its journal by other cluster members, defeating RTR standby takeover. Valid values are:
 - 0: feature disabled
 - 1: RTR resigns journal if appropriate, then stops.
 - 2: (default) RTR does not stop after resigning the journal and can recover if the network isolation condition ends.

To display the value of this parameter, use the `SHOW RTR/counter=jam_jnl_retain_mode` command, which displays one of the following values: `retain_jnl`, `resign_jnl_and_stop`, or `resign_jnl_and_wait`.

- **RTR_JNL_PARTITION_FAILBACK:** Define this to defeat the default behavior so that when an isolated node regains its connection to the network, partition instances resume in their prior mode, not in standby mode. See the `SET PARTITION/PRIORITY` command for more information.

For more details on these environment variables, see Table 2–3.

Starting and Setting Up RTR

2.13 Environment Variables Used by RTR

2.13.3 Compression of Event and Reply Data

Transaction data can be transmitted in a compressed format, to address the needs of users who wish to reduce their network bandwidth requirements for the transfer of such data. User data passed to RTR using the `rtr_reply_to_client()`, `rtr_broadcast_event()` and `rtr_ext_broadcast_event()` calls may optionally be compressed before being passed to the RTRACP process for transmission to the RTR router. The event or reply data are decompressed to their original state before being presented to the receiving applications.

Compression and decompression occur in the address space of client and server applications, so these processes will consume additional CPU resources when compression is in use. Compression is done using the zlib open source library. For further information, consult <http://www.gzip.org/zlib/>.

To ensure interoperability, all participating systems must be running a version of RTR that supports compression. Failure to observe this restriction may cause compressed data to be incorrectly delivered to applications expecting uncompressed data.

You cannot use compression and the `msgfmt` argument of `rtr_reply_to_client()`, `rtr_broadcast_event()`, or `rtr_ext_broadcast_event()` simultaneously.

Compression is controlled with the following environment variables defined on participating frontends and backends as follows:

On participating frontends to control compression of client broadcasts:

```
RTR_EVENT_COMPRESS_LEVEL
RTR_EVENT_COMPRESS_THRESHOLD
```

On participating backends:

```
RTR_EVENT_COMPRESS_LEVEL
RTR_EVENT_COMPRESS_THRESHOLD
RTR_REPLY_COMPRESS_LEVEL
RTR_REPLY_COMPRESS_THRESHOLD
```

The `EVENT_COMPRESS` variables control event-data compression. They are deployed on a frontend to control compression of outgoing client broadcasts, and on a backend to control compression of outgoing server broadcasts. The `LEVEL` variable controls compression amount or level; valid values are integers in the range 1-9. Higher levels cause better compression, at the cost of increased CPU usage. If unspecified, the zlib default compression level is used.

Starting and Setting Up RTR

2.13 Environment Variables Used by RTR

The `REPLY_COMPRESS` variables control outgoing server reply data compression, and are consequently deployed on the backends where the replies originate.

The `THRESHOLD` variable defines the size of the largest data packet *not* subject to compression; anything larger is compressed. A threshold value of 0, the default, disables compression. These variables are read once only, shortly after an application makes its first call to the RTR API. No setup is required on router nodes, or if no compression is wanted. Decompression is automatic, provided the interoperability criteria (see above) are met.

Compression settings and operations can be monitored for any RTR application process with the commands. Compression settings are displayed with:

```
RTR> show process/counter=api_compress*
```

The number of compressed data operations performed by an application process can be viewed with:

```
RTR> show process/counter=*compressed
```

The number of uncompressed (or raw) and resulting compressed bytes per operation can be viewed with either of the following commands:

```
RTR> show process/counter=*event*bytes*
```

```
RTR> show process/counter=*reply_to_client_bytes*
```

2.13.4 Flow Control Environment Variables

RTR flow control manages message flow between processes and nodes controlled by RTR. Flow control regulates the sending rate of a process to achieve maximum message throughput and avoid resource exhaustion. RTR flow control is designed to deal with short-term system overload; if flow control indicates frequent resource depletion, the topology of the system should be evaluated. Use `MONITOR TRAFFIC` to check for congestion rates on RTR links between nodes.

Within a facility, RTR monitors four role directions:

- frontend to router (FE=>TR)
- router to backend (TR=>BE)
- backend to router (BE=>TR)
- router to frontend (TR=>FE)

Starting and Setting Up RTR

2.13 Environment Variables Used by RTR

Messages travel from a sender to a recipient at a rate, controlled by RTR, that the recipient can handle. RTR achieves this by limiting the rate of the sender using *credits*. Each sending RTRACP asks its partner for credit or permission to send. When a recipient is prepared to receive data, it grants credits. Each time a sender sends data, its credit is reduced until it is exhausted. Exhausted credit must be replenished before more data can be sent. Availability of credits can be checked with the MONITOR FLOW display. If an application is sending many large messages, flow control may not close the application channel soon enough. This may cause the RTRACP to run out of memory.

For applications using large messages containing tens of thousands of bytes, environment variables are provided to adjust the flow control algorithm parameters: RTR_EVENT_CHANNEL_LIMIT_PC, RTR_MAX_CHANNEL_WAITQ_BYTES, and RTR_MAX_CHANNEL_FULL_COUNT. All apply to the ACP. Setting them affects all channels equally, and they are set once for all channels. These variables are described in Table 2-3.

When the WAITQ memory quota is exceeded, the RTRACP deletes all messages in the queue and returns a status of RTR_STS_CACHEXHAU, along with a "channel has been closed" message (`rtr_mt_closed`) which indicates that all messages were discarded in the application channel's queue.

2.13.5 Sizing for Channels and Sockets

Facilities do not require channels but networks links do. On OpenVMS, the number of channels is defined by the parameter CHANNELCNT that can be updated by changing MODPARAMS.DAT and running AUTOGEN. UNIX uses sockets, not channels.

To compute the number of channels and the maximum process count, use the rules in Table 2-2.

Table 2-2 Rules for CHANNELCNT and MAXPROCCNT

To compute:	For Parameter:	Parameter value must be greater than:
Channel count	CHANNELCNT	$(30 + (\text{number-of-processes} * 2) + (\text{number-of-links}))$
Maximum process count	MAXPROCCNT	$(\text{number-of-processes} + 50)$

2.13.6 Optional TID Values

_____ For V2 API TIDs Only _____

To avoid possible non-unique TID values for with the V2 API, an environment variable has been added which supports optional settings for TID values.

RTR V2 TIDs are 2 longwords in length. In certain circumstances with multiple interface cards and no DECnet network, a V2 API may encounter a non-unique TID seen across nodes due to a non-unique value in the high-order 2 bytes of the 2nd longword. You can uniquely set the high-order 2 bytes of the 2nd longword with the RTR_TID_OPTION environment variable using one of two possible settings:

```
$ DEFINE/SYS RTR_TID_OPTION value !where 0 < value < 65536  
$ DEFINE/SYS RTR_TID_OPTION -1 !uses the SCSSYSTEMID
```

2.13.7 Environment Variable Descriptions

Table 2–3 summarizes environment variables used by RTR.

Table 2–3 RTR Environment Variables

Environment Variable	Description
System Logicals and Directories:	
SYS\$NODE	Set by DECnet if configured; used to detect presence of DECnet.
RTR_DIRECTORY	Define to run RTR as a Service on Windows.
RTR\$DUMP_DIRECTORY	Directory for rtr_error.log and rtr.dmp
RTR_DUMP_DIRECTORY	Synonym for RTR\$DUMP_DIRECTORY.
RTRHELP	Specifies an alternate location for the RTR online help file (rtr.hlb).

(continued on next page)

Starting and Setting Up RTR

2.13 Environment Variables Used by RTR

Table 2–3 (Cont.) RTR Environment Variables

Environment Variable	Description
Notification Variables:	
RTR_FE_NOTIFICATION_MSG_COUNT	Defines how many times a frontend will disconnect the current router and attempt to reconnect with the preferred routers. The default is 3; that is, after three attempts the frontend remains connected to the current router and no longer bounces between routers. Minimum: 3, maximum: 100.
RTR_FE_NOTIFICATION_MSG_SECS	Defines the interval within which a frontend can change routers three times, in seconds. The default is 600 seconds, or 10 minutes (10*60). With the default, if a frontend fails three times in 10 minutes, it will stop changing routers. The minimum is 60 seconds, and the maximum, 12*60*60.
RTR_FE_NOTIFICATION_RESUME_SECS	Defines the interval for a frontend to remain connected to the current router, after three failed attempts to use the preferred routers list. Once the interval is over, the frontend will again try to connect to the preferred routers in the list. The default is 4*60*60 (4 hours); the minimum is 2 hours, and the maximum, 12 hours.

(continued on next page)

Starting and Setting Up RTR

2.13 Environment Variables Used by RTR

Table 2–3 (Cont.) RTR Environment Variables

Best Response Time Variable:

RTR_GOAL_RESPONSE

To ensure best throughput, RTR queues data that is to be sent from an application to the RTRACP and sends it in one operation. The send is initiated when RTR is about to wait for something to occur. In a threaded application that has made an RTR API call and is waiting for something outside RTR to occur, this could lengthen response time. To change RTR's performance goal from *best throughput* to *best response time*, define the application process environment variable RTR_GOAL_RESPONSE. Defining this variable can impact both throughput and application CPU usage.

HP-UX and Linux Cluster Variables:

RTR_CLU_MEM_NODES

Enables RTR to recognize the backend nodes of the cluster participating in the ACTIVE/STANDBY mode.

RTR_CLU_LCK_DISK

Enables RTR to maintain the "cluster node locks" on a common shared disk in the cluster.

Journaling Variables:

RTR_JNL_PARTITION_FAILBACK

Resets partition priorities from standby to a prior mode. See the SET PARTITION /PRIORITY command for more information.

RTR_JNL_RELEASE_SECS

Releases the journal after a given period of time.

RTR_JNL_RETAIN_MODE

Defines the level of support for journal host resignation.

RTR_JNL_RETAIN_SECS

Prevents premature journal release.

Default Node Affixes

RTR can accept a default nodename prefix or suffix from the environment. The prefix or suffix is applied to all node names referenced in facility creation, trim and extend operations, unless the nodename as entered already contains the period character '.' This functionality is controlled by the following environment variables:

RTR_DEFAULT_NODE_PREFIX

Defines a default node prefix for facility configuration commands. Example:

```
$ define/system RTR_DEFAULT_NODE_PREFIX "LOCAL:.ZKO."
```

(continued on next page)

Starting and Setting Up RTR

2.13 Environment Variables Used by RTR

Table 2–3 (Cont.) RTR Environment Variables

Environment Variable	Description
RTR_DEFAULT_NODE_SUFFIX	<p>Defines a default node suffix for facility configuration commands. Examples:</p> <p>OpenVMS:</p> <pre>\$ define/system RTR_DEFAULT_NODE_SUFFIX ".hp.com"</pre> <p>UNIX:</p> <pre>export RTR_DEFAULT_NODE_SUFFIX=".hp.com"</pre> <p>Windows:</p> <pre>set RTR_DEFAULT_NODE_SUFFIX=".hp.com"</pre>
RTR_DEFAULT_NODE_ALL	<p>If defined, overrides the setting that exempts nodes whose names contain a period from default prefix and suffix processing.</p>

Local Node Euphemism

When working with facilities, the nodename of '.' (a period or full stop) is an acceptable substitute for the local nodename. For example, the command:

```
RTR> create facility f1/frontend=./router=elsewhere
```

makes the computer executing the command a frontend in the facility named f1.

Flow Control Variables:

RTR_EVENT_CHANNEL_LIMIT_PC

Describes the channel queue threshold which if exceeded causes broadcasts to be discarded. Discarded broadcasts are counted by the facility counter `fdb_cn_bm_dest_brd_lost` and the process counter `bm_brd_lost`. Dropped broadcasts are also evident as `BRODISCAC` (cache congestion) entries in the RTR log file.

Raise this limit to reduce the likelihood of broadcast event data from being discarded due to full channel queues. The limit is expressed as a percentage of the channel capacity variable `RTR_MAX_CHANNEL_WAITQ_BYTES`. The default value is 200%. Choosing a value of > 100% will reduce the likelihood that inbound event data is rejected before flow control has time to throttle the sender due to a full channel queue condition.

(continued on next page)

Starting and Setting Up RTR

2.13 Environment Variables Used by RTR

Table 2–3 (Cont.) RTR Environment Variables

Environment Variable	Description
RTR_MAX_CHANNEL_FULL_COUNT	Defines for each channel the maximum number of attempts the RTRACP allows for a message to be placed in a full queue. The default value is 20000. This number may be set to a maximum of RTR_MAX_CHANNEL_WAITQ_LIMIT/64000, where 64000 is the maximum number of bytes allowed in an application message.
RTR_MAX_CHANNEL_WAITQ_BYTES	<p>Defines the number of bytes that constitutes a full channel. Flow control kicks in when the threshold is reached. When a channel queue exceeds this number of bytes, RTR behavior changes to:</p> <ul style="list-style-type: none">- discard subsequent broadcasts/events received for the channel-suspend granting of flow-control credit requests for the facility (both broadcasts and transactions)- closes the channel if the condition persists for longer than MAX_CHANNEL_FULL_COUNT seconds. The default value is 100,000 bytes. <p>You can set the RTR_MAX_CHANNEL_WAITQ_BYTES variable somewhat larger than the total amount of data that can possibly occur in one transaction or one set of broadcasts. This value might be a few million bytes for a typical large-message application.</p> <p>Raising this limit affects all application channel queues held by the ACP. As ACP virtual memory usage will consequently increase, this must be considered when sizing ACP process quotas. For further details, see Section 2.11.</p>
Compression Variables:	
RTR_EVENT_COMPRESS_LEVEL	Enables unconditional compression and decompression of event data in levels from 1 to 9 (9=highest level of compression).
RTR_EVENT_COMPRESS_THRESHOLD	Enables unconditional compression and decompression of reply data.
RTR_REPLY_COMPRESS_LEVEL	Enables unconditional compression and decompression of reply data in levels from 1 to 9 (9=highest level of compression).

(continued on next page)

Starting and Setting Up RTR

2.13 Environment Variables Used by RTR

Table 2–3 (Cont.) RTR Environment Variables

Environment Variable	Description
RTR_REPLY_COMPRESS_THRESHOLD	Defines the size of the largest data packet <i>not</i> subject to compression; anything larger is compressed. A threshold of 0, the default, disables compression.
Networking Variables:	
RTR_PREF_PROT	Default is RTR_DNA_FIRST for OpenVMS nodes with DECnet; RTR_TCP_FIRST for other platforms. Other possible values are RTR_DNA_ONLY and RTR_TCP_ONLY.
RTR_DNA_PREFIX RTR_TCP_PREFIX RTR_TUNNEL_PREFIX	These command interfaces allow link names to be prefixed to indicate special treatment, e.g. <code>tcp</code> . If a prefixed name conflicts with a real node in the target environment, the value of the prefix string can be changed using these environment variables.
RTR_BIND_HOST	Restricts network connections to a specific interface by specifying the interface name.
Break-in Detection and Evasion Variables:	
RTR_LGI_WINDOW	Enable customization of break-in detection and evasion; for additional information, see Section B.2.3.
RTR_LGI_BRK_LIM RTR_LGI_HID_TIM	
Optional TID Values:	
RTR_TID_OPTION	Set to a value ($0 < \text{value} < 65536$) or -1 to use SCSSYSTEMID.

(continued on next page)

Table 2–3 (Cont.) RTR Environment Variables

**Quorate-Router Voting-Timeout
Variable:**

RTR_CRM_TR_ABORT_TO_SECS	Controls the amount of time a quorate router will allow a transaction to linger in the voting state without a connection to an active BE partition before aborting the transaction with the RTR status COMSTAUNO. Use when the default value is insufficient for complex cluster transitions. The minimum is 60 sec and the maximum settable value is INT_MAX. Choose a value greater than your cluster transition time if needed.
--------------------------	--

Revert to V3/V4 Behavior:

RTR_IOS_CHANNEL_TYPE 0	Reverts to V3/V4 behavior for the V2 API.
------------------------	---

Define Remote Username:

RTR_RSH_REMOTE_USER	When using the .rhosts file to control remote access, user names on the local and remote systems must match. If they do not, use this environment variable to define your user name on the remote system.
---------------------	---

2.14 Network Transports

RTR supports multiple network transports with a default behavior.

If an attempt to create a network connection to a remote node fails, RTR retries the connection attempt using an alternate transport protocol if one is available. The order in which the supported transport protocols are used depends on the host operating system.

- OpenVMS - first DECnet then TCP/IP
- All other platforms - first TCP/IP, then DECnet if available

If a connection attempt fails on all available protocols, it is retried at a later time starting again with the first transport protocol.

If an established link fails, RTR automatically initiates a reconnection of the link, starting with the first transport protocol for the platform, regardless of the transport employed when the link failed.

For information on dual-rail and multihome environments, see Section 2.14.4.

Starting and Setting Up RTR

2.14 Network Transports

2.14.1 Specifying the Link Transport Protocol

It is possible to override the protocol failover mechanism by specifying the transport protocol to be employed for a link by naming links to include a transport selecting prefix. Prefixing names of nodes with `tcp.` and `dna.` specifies TCP/IP or DECnet as the required transports respectively. These prefixes cause the local node to employ only the specified transport protocol when attempting a connection on the link to which the prefix has been applied. Using a protocol prefix on one node does not prevent a remote node from connecting using some other transport.

For example, to specify the facility FAX1 which uses only the DECnet transport, two routers (DNET1 and DNET2), two backends (SRV1 and SRV2) and many frontends, use the following command:

```
RTR> create facility FAX1 /frontend=(dna.FE1,dna.FE2,dna.FE3 ....)
      /router=(dna.DNET1,dna.DNET2)
      /backend=(dna.SRV1,dna.SRV2)
```

Creating a facility that uses only TCP/IP would use a command like this:

```
RTR> create facility FINANCE
      /frontend=(tcp.client1,tcp.client2,tcp.client7 ....)
      /router=(tcp.routr1,tcp.routr2)
      /backend=(tcp.srv1,tcp.srv2)
```

2.14.2 Using RTR with DHCP and Internet Tunnels

When using RTR with Dynamic Host Configuration Protocol (DHCP) or an internet tunnel, a node name may not be fully known; special naming techniques are provided for these conditions.

Anonymous Clients

RTR allows the use of wildcards when specifying the frontends from which a router is permitted to accept connections (that is, in the facility definition on the router). Valid wildcard characters are asterisk (*), percent sign (%), and question mark (?). Using a wildcard character at facility configuration time will result in the creation of a template link.

When operating RTR in conjunction with internet tunnels, a client system outside of the corporate firewall uses tunnel software to obtain a secure channel from the Internet to inside the corporate domain. The tunnel client is assigned an address by the tunnel server from a pool when the tunnel software starts up.

Starting and Setting Up RTR 2.14 Network Transports

When an RTR router receives a connection request from RTR running on this client, the source address of the connection is the address assigned by the tunnel server. There is no longer a fixed relationship between the client and its address. You can configure the router to accept such a connection. Use wildcards to define the frontend nodes with all the possible addresses that the tunnel server can assign to tunnel clients, for example:

```
RTR> create facility . . ./frontend=*.pool.places.dec.com
```

This command enables all nodes connecting through the tunnel to connect as frontends. The anonymous client feature may also be used with frontends that are using DHCP for TCP/IP address assignment.

Using the Tunnel Prefix

By using the node name prefix “tunnel.”, it is possible to configure RTR to accept a network connection from a particular remote node even if it is connecting through an internet tunnel using an unknown pseudoadapter address. This method allows stricter access control than the anonymous client feature where wildcards may be used when specifying a remote node name. For example, on the router node behind a firewall, the facility definition could include:

```
RTR> create facility . . ./router=router.rtr.dec.com -  
/frontend=tunnel.client.rtr.dec.com
```

The definition on the frontend could be:

```
RTR> create facility /router=router.rtr.dec.com -  
/frontend=client.rtr.dec.com
```

Troubleshooting Tunnel and Wildcard Connections

To assist in diagnosing connect-acceptance problems, use the monitor picture ACCFAIL. This picture displays the recent history of those links from which the local node has refused to accept connections. It also displays the failed link name as provided by the network transport, and can assist in rapidly identifying any problems.

TCP Services File

RTR uses the TCP/IP port number 46000 for the network communication daemon `rtr rtrd`. Refer to the *HP Reliable Transaction Router Installation Guide* for how to reserve this port for UNIX systems.

Starting and Setting Up RTR

2.14 Network Transports

TCP Port Usage If usage of TCP is enabled, the RTR usage of TCP ports is as follows:

- The RTR daemon (process rtrd) binds to port 46000 and listens for port number requests.
- Each new RTR ACP and user command server instance allocates a port on which to listen for incoming connections. It does so by searching for a free port, commencing its search at port 46001. Once a free port is found, the process binds to the port and registers the port number in an internal database accessible to the daemon.

Note that restarting a process does not always enable the process to reclaim the same port number since the port may not be available for immediate reuse.

It is currently not possible to change these port number assignments.

2.14.3 Network Protocol Selection

To specify the network protocol, you can prefix a node name with a .dna (DECnet) or .tcp (TCP/IP) string. Using the .dna prefix assumes that the default network transport is TCP/IP. The default network transport can be changed to DECnet with the environment variable RTR_PREF_PROT. The applicable environment variables are:

```
set RTR_PREF_PROT=RTR_TCP_FIRST
set RTR_PREF_PROT=RTR_TCP_ONLY
set RTR_PREF_PROT=RTR_DNA_FIRST
set RTR_PREF_PROT=RTR_DNA_ONLY
```

These statements set the choice of network transport to TCP/IP with fallback to DECnet, TCP/IP only, DECnet with fallback to TCP/IP or DECnet only.

Network Protocol Selection on OpenVMS The default network transport protocol for RTR on OpenVMS is DECnet. You may change the default to TCP/IP by removing this line from RTR\$STARTUP.COM:

```
$ DEFINE/SYSTEM RTR_PREF_PROT RTR_DNA_FIRST
```

If you are using TCP/IP, you must use the node name prefix dna. if you want DECnet transport to be used.

If you are using DECnet as the default, you must use the node name prefix tcp. to connect to other nodes using TCP/IP transport.

If the value of the logical RTR_PREF_PROT is changed, the new value takes effect only after RTR has been restarted.

HP Reliable Transaction Router Version 5.1 for OpenVMS can use either TCP/IP Services for OpenVMS or TCPware Version 5.1 as the TCP/IP transport layer. For more details on modifying RTR\$STARTUP.COM on OpenVMS, see the full OpenVMS installation instructions in the *HP Reliable Transaction Router Installation Guide*.

Restricting Network Connections Ordinarily RTR accepts network connections on any configured interface in the system. Connections may optionally be limited to a specific interface by specifying the interface name with the environment variable RTR_BIND_HOST. This variable is read by the ACP, daemon and command server processes. The name supplied must be resolvable to an IP address (using gethostbyname()). Note that only the first IP address obtained is used.

It is an error if the value of the bind host cannot be resolved, or translates to an interface that cannot be bound, and entries in the RTR log file will result. The affected process will continue to run, but will be unable to accept incoming network connections.

Warning: RTR currently does not check if the value of BIND_HOST would prevent connections from subsequently configured nodes.

2.14.4 Dual-Rail Setup

You may need to set up a dual-rail (multihome) environment to accommodate a firewall, segregate a network subnet or possibly to ease the load on an Ethernet line. In some situations, this can improve performance.

For dual-rail or multihome setup, consider these topics:

- Physical network card setup
- RTR facility setup
- DNS (Domain Name System) support
- Tunnel configurations

Physical Network Card Setup

To set up frontends and routers in a dual-rail environment, use the following steps:

1. Install two network cards in the dual-rail node. This can be your frontend or your router. The two configurations are shown in Figure 2–3 and Figure 2–4.
2. Assign each network card a unique IP address.

Starting and Setting Up RTR

2.14 Network Transports

3. Use static IP addresses for the network cards - check your operating system installation documents for how to use the appropriate utility or application to perform this setup.
4. Create an RTR facility that spans all nodes. Specify the RTR Router (TR) on the node with the two network cards, and use an * wildcard when executing the Create Facility command on the router, (see the example in RTR Facility Setup).

For example, the configuration shown in Figure 2–3 illustrates a firewall in a configuration with three RTR nodes and two network cards installed on the router.

Figure 2–3 Dual-Rail Configuration with Network Cards on a Router

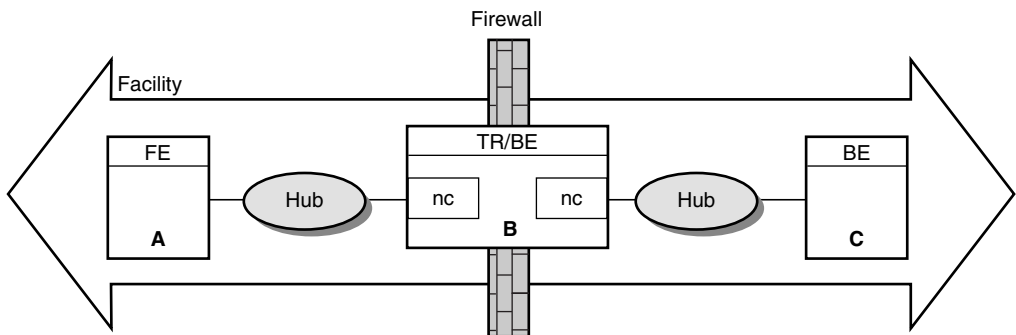

VM-0731A-AI

In Figure 2–3, Node A is a frontend, Node B, with the two network cards (nc), is both a router and a backend, and Node C is a backend. The hubs are Ethernet hubs. Figure 2–4 illustrates a frontend with two network cards.

Figure 2–4 Dual-Rail Configuration with Network Cards on a Frontend

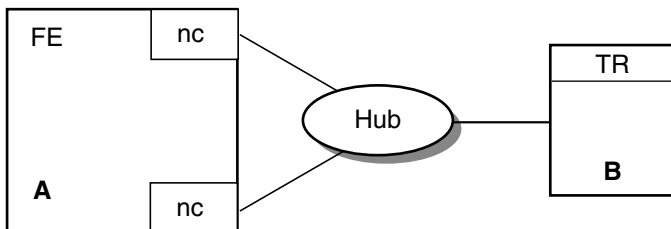

VM-0732A-AI

RTR Facility Setup

To set up the dual-rail environment, you can, as an example, create Facility A on three physical nodes (configuration shown in Figure 2–3) with the following commands:

Use this Create Facility command:	On:
RTR> CREATE FACILITY A /Frontend=A /Router=B	The frontend, node A.
RTR> CREATE FACILITY A /Router=B /Frontend=(A,*) /Backend=B	The router, node B.
RTR> CREATE FACILITY A /Router=B /Backend=C	The backend, node C.

Note

To ensure correct node recognition, include an explicit node name of a known frontend with a wildcard.

RTR resolves addresses to one name in the DNS Server when you use a wildcard for frontends from a router.

Starting and Setting Up RTR

2.14 Network Transports

2.14.5 DNS Server Support

A host with more than one network interface is multihomed. In a multihomed configuration, care must be taken to ensure that the `gethostbyname` function returns the list of all possible network addresses for the host. Otherwise, RTR may reject connections when it cannot recognize the host. To return the address list, use a correctly configured DNS. Using the `/etc/hosts` file on a UNIX server does not return the list of addresses.

Networking support for machines with multiple network adapters allows multiple IP connection targets for any host. With this capability, any pair of machines connected by multiple network paths can fail over to an alternate path if the primary path becomes unusable.

RTR determines the set of IP addresses to be used for a remote host when the host name is looked up using the `gethostbyname()` API. Depending on your platform and site policies, the IP address information will be provided by UNIX hosts file entries, OpenVMS TCPIP hosts entries, or by one or more BIND servers. Examples for a system named 'host1' with two interfaces follow:

UNIX hosts file:

```
1.2.3.4    host1_interfaceb
1.2.4.4    host1_host1_interfaceb
```

OpenVMS:

```
TCPIP> set host "host1_interfaceb"/address=1.2.3.4
TCPIP> set host "host1_host1"/address=1.2.4.4/alias="host1_interfaceb"
```

Given the information above, RTR will attempt to connect to remote system 'host1' using address 1.2.4.4 first. Should this connection attempt fail, RTR will retry using address 1.2.3.4.

Connection attempts that invoked address failover can be monitored using the RTR monitor picture `Netstat`.

Note that connection attempts using IP to unreachable hosts usually terminate with a timeout condition, but are often intercepted by the RTR connection timeout whose default value is 60s. This is followed by a further quiescent period whose default value is 90s. You may wish to consider changing the values for these timers for a faster reconnection rate.

Linux INET Interface Support:

Beginning with Red Hat Enterprise Linux WS 2.1 and Red Hat 9.0, the `/etc/hosts` file may contain an entry matching the hostname with IP address 127.0.0.1. A sample default `/etc/hosts` file on those platforms would look like the following:

```
-- SAMPLE /etc/hosts file --
# Do not remove the following line, or various programs
# that require network functionality will fail.
127.0.0.1      hostname localhost.localdomain  localhost
-----
```

Thus, the `gethostbyname()` function returns address 127.0.0.1 for any query on `hostname`. RTR on Linux ensures smooth operation by enumerating all INET interfaces, adding to its cache the IP address associated with each INET interface that is not a loopback interface and is UP (as shown by the `ifconfig` command).

To view the interfaces on your system, issue the command `ifconfig -a`; this command reveals which interfaces are loopback, and which are UP.

2.14.6 Tunnel Configurations

If a tunnel separates the frontends from the routers, configure the frontends on the routers with names corresponding to the pseudo-adaptor addresses assigned by the tunnel. If these are unpredictable, you can use wildcards on the routers only.

If a tunnel separates the routers and the backends, configure each with respect to the other with the name prefix "tunnel."

2.15 Running RTR as a Service on Windows

Once the RTR as Service has been installed (refer to the *HP Reliable Transaction Router Installation Guide*), RTR can be started or stopped from the Control Panel/Services panel using the START and STOP buttons provided.

- To start RTR, click on the START button.
- To stop RTR, click on the STOP button.

Starting and Setting Up RTR

2.15 Running RTR as a Service on Windows

Note

Pressing START and STOP or the reverse in quick succession (within approximately 5 seconds, depending on the speed of your computer) may cause undesirable results because the Service executes quickly, making available the other action button. However, the requested RTR action may not have completed when the second action button is pressed. It is therefore possible that the STOP action may be blocked by an incomplete START action. Although the Service will claim to be stopped, RTR may in fact remain started. Pressing whichever action button is functioning should repair the problem.

By default, RTR will not restart automatically at system reboot. To change this, set the Control Panel/Services entry for RTR.

2.15.1 Customizing the RTR Windows Service

When starting RTR, the Service looks for the file `UsrStart.RTR` in the RTR home directory. When it finds the file, the Service executes any RTR commands it may contain. RTR commands from `UsrStart.RTR` execute after RTR has been started.

From the point of view of the Service, the RTR home directory is found in the system-level environment variable `RTR_DIRECTORY`, or, if that is not defined, then the directory from which the Service was executed.

For the RTR Service to use it, `RTR_DIRECTORY` must be defined in the system-level environment variables list, not the user-level environment variables list. Also, the system must be rebooted after the definition of `RTR_DIRECTORY` is either created or changed for it to be used.

If a user-level copy of `RTR_DIRECTORY` exists, it must identify the same RTR home directory as the system-level copy, or if there is no system-level copy, the directory containing the currently registered Service program. If it does not, behavior of RTR is undefined.

Caution

Changing the value of `RTR_DIRECTORY`, or reregistering the service from another directory while RTR is running, is dangerous and should be avoided. Starting RTR from the Service, then stopping it from DOS (or the reverse) should also be avoided.

Starting and Setting Up RTR

2.15 Running RTR as a Service on Windows

If you put STOP RTR in the `UsrStart.RTR` file, it will stop RTR. The Service will not detect that RTR has been stopped and will offer only the STOP action button. Pressing the STOP button will fix the problem.

Similarly, when the Service stops RTR, it searches the RTR home directory for the file `UsrStop.RTR` and, if the file exists, it executes any RTR commands in it. User commands from `UsrStop.RTR` are executed before RTR has stopped.

Caution

If you put QUIT or EXIT in either `UsrStart.RTR` or `UsrStop.RTR`, RTR will exit improperly. As a result, an RTR command server process incorrectly remains active, preventing the Service from starting or stopping RTR, and preventing the RTR command server from exiting. Because the RTR command server executes under the SYSTEM account, it cannot be stopped from Task Manager other than by the SYSTEM account.

2.15.2 Files Created by the RTR Windows Service

If RTR is started from the Service rather than from a Command Prompt window, several files are created in the RTR root directory.

- `SrvcIn.Txt` is created to act as a command line input source
- `SrvcOut.Txt` acts as a container for console output
- `RTRStart.RTR` contains the startup commands.

When the Service stops RTR, it recreates `SrvcIn.Txt` and creates `RTRStop.RTR` for stopdown commands. Creation of these files is unconditional; that is, they are created every time RTR is started or stopped, whether or not they already exist. RTR will therefore ignore (and overwrite) any changes made to one of these files.

2.16 Assignment of Processing States for Partitions

RTR assigns a primary or secondary processing state to a partition (or a key-range definition), consisting of one or more server application channels, which may or may not share a common process. On a given backend, all such server application channels belonging to a given partition will have the same processing state, but the processing state for the same partition will normally be different on different backends. The exception is the case of the standby processing state. Because a given partition can have multiple standby backends, several of these may be in a given state.

Starting and Setting Up RTR

2.16 Assignment of Processing States for Partitions

RTR determines the processing state of a given partition through the use of a globally managed sequence number for that partition. By default, the RTR router automatically assigns sequence numbers to partitions during startup. When a server starts up on a backend and declares a new partition for that backend, the partition initially has a sequence number of zero. When the partition on that backend makes an initial connection to the router, the router increases its sequence number count for that partition by one and assigns the new sequence number to the new backend partition. The active backend with the lowest backend partition sequence number gets the primary processing state in both shadow and standby configurations. That backend is also referred to as the primary backend, though the same backend could have a standby processing state for a different partition.

Under certain failover conditions, backend partitions may either retain their original sequence number or be assigned a new sequence number by the router. If a failure is caused by a network disruption, for example, a backend partition retains its sequence number when it reconnects with the router. However, if the backend node is rebooted or RTR is restarted on the backend node, a new sequence number is assigned by the router to any partitions that start up on that backend. Routers will only assign new sequence numbers to backend partitions that have a current sequence number of zero, or if the backend partition is joining an existing facility and has a sequence number that conflicts with that of another backend partition on another node.

Sequence number information is obtained from the `SHOW PARTITION/FULL` command. In the output of this command, the sequence number is indicated by the “relative priority.” Example 2–6 shows use of the `SHOW PARTITION/FULL` command from a router partition. In this example, the backend partition called Bronze has a sequence number of 1, and the backend partition called Gold has a sequence number of 2.

Starting and Setting Up RTR

2.16 Assignment of Processing States for Partitions

Example 2-6 SHOW PARTITION/FULL for Routers

```
Router partitions on node SILVER in group "test" at Fri Nov 15 14:51:16 2002
Facility:                Metals      State:                    ACTIVE
Low bound:                0          High bound:              4294967295
Failover policy:          fail_to_standby
Backends:                 bronze,gold
  States:                 pri_act,sec_act
  Relative priorities:    _1,2
Primary main:             bronze     Shadow main:            gold
```

Example 2-7 shows the output of the SHOW PARTITION/FULL command for each backend node.

Example 2-7 SHOW PARTITION/FULL for Backends

```
Backend partitions on node BRONZE in group "test" at Mon Mar 22 14:52:32 1999
```

```
Partition name:                pl
Configuration:-
Facility:                Metals      State:                    pri act
Low bound:                0          High bound:              4294967295
Active servers:          0          Free servers:            1
Transaction presentation: active     Last Rcvy BE:           gold
Active transaction count: 0          Transactions recovered:  0
Failover policy:         fail_to_standby
Master router:          silver
Recovery retry count:    0          Resource Manager:
Features:                Shadow,NoStandby,Concurrent
```

```
Backend partitions on node GOLD in group "test" at Mon Mar 22 14:54:12 1999
```

```
Partition name:                pl
Configuration:-
Facility:                Metals      State:                    sec act
Low bound:                0          High bound:              4294967295
Active servers:          0          Free servers:            1
Transaction presentation: active     Last Rcvy BE:           bronze
Active transaction count: 0          Transactions recovered:  0
Failover policy:         fail_to_standby
Master router:          silver
Recovery retry count:    0          Resource Manager:
Features:                Shadow,NoStandby,Concurrent
```

Starting and Setting Up RTR

2.16 Assignment of Processing States for Partitions

2.16.1 Sequence Numbers in a Shadow Configuration

Figure 2–5 shows how sequence numbers are initially assigned in a simple partition with two backends named Bronze and Gold, and a router named Silver.

Figure 2–5 Assignment of Sequence Numbers in a Shadow Configuration

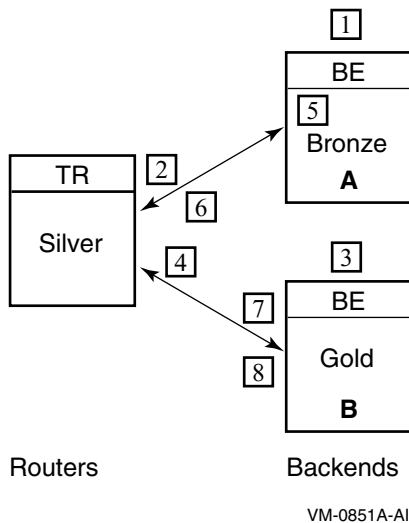

Table 2–4 Steps to Assigning Sequence Numbers

Step	Action
1	A partition (with shadowing enabled) is started on backend Bronze.
2	The partition on Bronze obtains sequence number 1 from the router and becomes the primary.
3	Another server on the same partition (with the same attributes) is started on backend Gold.
4	The partition on backend Gold obtains sequence number 2 from the router and becomes the secondary.

(continued on next page)

Starting and Setting Up RTR

2.16 Assignment of Processing States for Partitions

Table 2–4 (Cont.) Steps to Assigning Sequence Numbers

Step	Action
5	Backend Bronze crashes and reboots (the partition sequence number on Bronze is reset to 0). The partition on backend Gold goes into Remember mode.
6	When the server starts, the partition on backend Bronze obtains sequence number 3 from the router and becomes the secondary; backend Gold now becomes the primary.
7	The network connection from router Silver to backend Gold fails. The partition on backend Bronze becomes the primary. The partition on backend Gold loses quorum and is in a wait-for-quorum state.
8	The network connection to backend Gold is reestablished. The partition on backend Gold retained its original sequence number of 2 and retains the primary role while the partition on backend Bronze reassumes the secondary role.

Alternatively, the roles of backend nodes can be specifically assigned with the `/PRIORITY_LIST` qualifier to the `SET PARTITION` command. The `/PRIORITY_LIST` qualifier can be used to ensure that when Bronze fails and then returns to participate in the facility, it becomes the active primary member. To ensure this, the following command would be issued on both backend systems immediately after creating the partition:

```
SET PARTITION test/PRIORITY_LIST=(bronze,gold)
```

Use the same priority list order on all partition members. If a different list is used, the router will determine the sequence number for conflicting members through the order in which those members joined the facility. For example, if the above command were issued only on Bronze, and Gold had the opposite priority list, the router would assign the lower sequence number to the backend that joined the facility first.

2.16.2 Setting Failover Policy

Use the `SET PARTITION` command with the `/FAILOVER_POLICY` qualifier to establish whether to fail over to a shadow or a standby backend. For example, use the `/FAILOVER_POLICY` qualifier to select a new active primary in configurations where shadowing is enabled. This qualifier takes precedence over the `/PRIORITY_LIST` qualifier. Use the `/PRIORITY_LIST` qualifier to determine the failover order for specific nodes. It is most useful in cluster configurations where it can specify the exact failover order for the nodes within the cluster.

Starting and Setting Up RTR

2.16 Assignment of Processing States for Partitions

For example, in a standby facility on a cluster of four nodes, the `/PRIORITY_LIST` qualifier can specify the desired order of failover for those cluster members. Some machines within a cluster may be more powerful than other machines. This feature allows for the most efficient use of those machines.

2.17 Router Selection in Facilities

Within a given facility, routers and backends connect to one another, although nodes with a given role do not connect to nodes with the same role, that is, routers do not connect to other routers. Frontends connect to only one router at a given time. This selected router is called the *current router* for that frontend in a facility.

A backend connects to all routers defined within a facility. The connected router with the lowest network address is designated the master router. Internally, a node is identified through a structure called the Kernel Net ID. The Kernel Net ID is a concatenation of all network addresses a node is known as for all the protocols and interfaces that it supports. The master router designation is only relevant to a backend. It is where the backend goes to obtain and verify partition configuration and facility information.

Routers are made known to the frontend systems through the list specified in the `/ROUTER=(list)` qualifier to the `CREATE FACILITY` command issued on the frontend or the router. This list specifically determines the *preferred router*. If the first router specified is not available, the next one on the list is chosen. When the facility is created on the frontend, the list of routers specified can be a subset of the routers contained within the entire facility. Use this to prevent a frontend from selecting a router reserved for other frontend systems. Failback of routers to the preferred router is supported. Thus if the preferred router is not available, but later becomes available, the frontend automatically fails back and connects to its preferred router.

You can also use the `/BALANCE` qualifier with the `CREATE` or `SET FACILITY` commands to randomize router selection. For more information on use of the `/BALANCE` qualifier, see Section 2.8.

2.18 Clustering Considerations for RTR Standby Servers

The standby server remains idle while the RTR active server performs its work, accepting transactions and updating the database. A failure of the active RTR server occurs when either the process itself crashes, when the `RTRACP` on the node crashes or when the node itself becomes unreachable due to an operating or hardware fault, such as a network interface failure. When the active server fails, the standby server takes over, recovers any in-progress

Starting and Setting Up RTR

2.18 Clustering Considerations for RTR Standby Servers

transactions, updates the database, and communicates with clients until the active server returns.

There can be many concurrent instances of the active server, and failover occurs only when the last remaining server has also failed. There can be many instances of a standby server. Activation of the standby server is transparent to the user. Standby failover behavior depends on whether the standby and active nodes are members of the same cluster and whether the cluster is a recognized or unrecognized cluster.

The clustering systems that RTR supports as recognized clusters are OpenVMS clusters, Tru64 UNIX Clusters (TruClusters), HP-UX Clusters and Linux Clusters. RTR supports Windows clusters as unrecognized clusters with file sharing. RTR treats all other cluster systems (for example, Sun) as non-clustered. Figure 2–6 shows a sample configuration of a clustered system.

Figure 2–6 Sample OpenVMS Cluster Running RTR

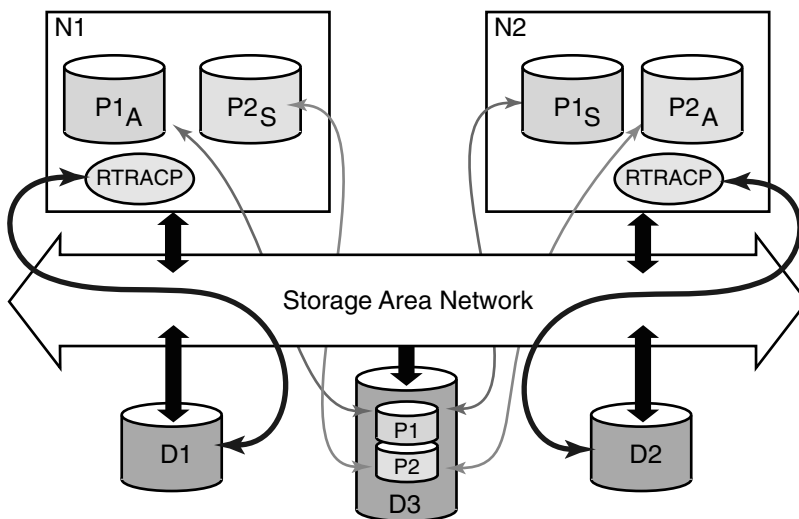

VM-0915A-AI

Starting and Setting Up RTR

2.18 Clustering Considerations for RTR Standby Servers

2.18.1 OpenVMS Clusters and Tru64 Truclusters

OpenVMS and Tru64 UNIX clusters use mechanisms such as a lock manager to deal with file sharing and sustained availability. The cluster configuration includes dual-ported disks to provide access from multiple CPUs.

In Figure 2–6, N1 and N2 are nodes in an OpenVMS cluster. When the active process P1_A fails, the standby process P1_S takes over. Whenever standby takeover occurs as part of takeover activity, the standby server undergoes a recovery process in which it tries to recover any uncertain transactions that the active server was processing when the failure occurred.

If node N1 failed, then RTR on node N2 opens the failed node's RTR journal and recovers any uncertain transactions from it, thereby ensuring transaction consistency. If only the RTR server process failed, the failed node (N1) still has its journal open so RTR does not try to open the journal directly. Instead, it asks the remote RTR system N2 to recover any uncertain transactions. This behavior imposes certain requirements on the accessibility of the journal.

2.18.1.1 Journal Location

Since the node that takes over needs to open the journal of the failed node, this journal must be placed on the cluster file system. If the journal is not on the cluster file system, the standby recovery process will continue to scan the file systems for the journal and the partition will never come out of recovery. As long as RTR is unable to access the required journal and the system operator does not enter an overriding system management command, the partition state remains in `lcl_rec_fail`.

2.18.1.2 Journal Locking

On OpenVMS clusters and Tru64 TruClusters, RTR uses the distributed lock manager (DLM) to coordinate access to the journal file.

Normally each node locks and opens its own journal file. During recovery, some other node may receive the lock and open the journal. However, when the owning node is restored, RTR will request release of the journal. In this case, the remote node will release the lock on this journal, and the owner node can open its journal.

On OpenVMS and Tru64 Clusters, If the node loses cluster quorum, then RTR releases locks on this journal and lets another node take over.

RTR uses the distributed lock manager (DLM) to coordinate access to the journal file. Normally each node locks and opens its own journal file. During recovery, some other node may receive the lock and open the journal. However, when the owning node is restored, RTR will request release of the journal. In this case, the remote node will release the lock on this journal, and the owner

Starting and Setting Up RTR

2.18 Clustering Considerations for RTR Standby Servers

node can open its journal. If the node loses cluster quorum, then RTR releases locks on this journal and lets another node take over.

2.18.1.3 Cluster Communications on OpenVMS and Tru64

When setting up networks and cluster communications in an OpenVMS or Tru64 cluster that are intended for RTR standby operations, avoid the situation where RTR loses quorum on the node while the OpenVMS or Tru64 cluster has quorum. This can happen if there is one interface for cluster traffic and a completely separate interface for network traffic (IP, DECnet). In this case, if the network interface breaks, then RTR will view the node as unreachable and therefore inquorate.

However, since cluster communication is still intact, the operating system does not lose cluster quorum. Since RTR has lost quorum, another node will try to take over, but since the operating system cluster has not lost quorum, the lock on the journal will not be released and recovery will not complete. The key point is to avoid situations where a backend node can lose network communication to its RTR routers yet remain a viable member of its cluster.

2.18.2 HP-UX and Linux Clusters

HP-UX and Linux clusters, unlike OpenVMS and Tru64 Clusters, are not shared - all clusters. HP-UX uses HP Serviceguard and Cluster File System (CFS) and Red Hat Linux uses the Cluster-suite and Global File System (GFS) for clustering.

For enabling RTR to recognize the backend nodes of the cluster participating in ACTIVE/STANDBY configuration, the following environmental variable should be set:

```
RTR_CLU_MEM_NODES= "BE1, BE2"
```

In a ACTIVE/STANDBY configuration, if one of the nodes in the cluster fails, then RTR on the other node opens the failed node's RTR journal and recovers any uncertain transactions from it, thereby ensuring transaction consistency.

2.18.2.1 Journal Location

Since the node that takes over needs to open the journal of the failed node, this journal must be placed on a common disk shared in the cluster. If the journal is not on shared disk in the cluster, the standby recovery process will continue to scan the file systems for the journal and the partition will never come out of recovery. As long as RTR is unable to access the required journal and the system operator does not enter an overriding system management command, the partition state remains in `lcl_rec_fail`.

Starting and Setting Up RTR

2.18 Clustering Considerations for RTR Standby Servers

2.18.2.2 Journal Locking

RTR uses the file locking mechanism to coordinate access to the journal file. By default, the locks are maintained in the RTR home directory. If RTR is configured in ACTIVE/STANDBY mode, these locks must be maintained on a common shared disk in the cluster.

In order to maintain these locks on a common shared disk in the cluster, the following environmental variable should be set:

```
RTR_CLU_LCK_DISK="/dev/vx/dsk/rtrdata/rtr_files"- for HP-UX I64
```

All backend nodes in the cluster must use the same disk for maintaining the "cluster node locks".

Normally each node locks and opens its own journal file. During recovery, some other node may receive the lock and open the journal. However, when the owning node is restored, RTR will request release of the journal. In this case, the remote node will release the lock on this journal, and the owner node can open its journal. If RTR loses quorum, then it releases the locks on this journal and lets another node take over.

2.18.3 Windows Clusters

Windows clusters, unlike OpenVMS and Tru64 Clusters, are not shared-all clusters. Windows clusters use the concept of *host-based clustering*, that is, one node physically mounts the shared disks and makes the shared disks available as a network share to all other nodes in the cluster. If the host node fails, then one of the other nodes will rehost the disks. This rehosting is handled by the Windows clustering software. Only two-node Windows cluster configurations are supported for RTR. In terms of Windows clusters, RTR is an application and the RTR journals are the database resource that fails over between the Windows cluster servers. (A good reference for Windows clustering information is Joseph M. Lamb's *Windows 2000 Clustering and Load Balancing Handbook* available from Prentice-Hall.)

2.18.3.1 Journal Location

The RTR journal for both Windows servers must be located on the same disk on the SCSI bus that is shared between the two cluster servers. The RTR registry entry for the journal must be set to the same value on both server nodes. Furthermore, the registry entry should specify the journal disk using the path qualified by the cluster name. For example, if the cluster name is ALPHA_CLUSTER, and the journal disk has the cluster share name DISK1, then the RTR journal registry entry should be entered as

```
\\ALPHA_CLUSTER\DISK1
```

Starting and Setting Up RTR

2.18 Clustering Considerations for RTR Standby Servers

which can be modified using the Registry Editor. The registry key for the journal is found under

```
\HKEY_LOCAL_MACHINE\SOFTWARE\Hewlett-Packard Company\  
HP Reliable_Transaction Router\Journal
```

There is no default and the value must be in the given format. If the journal is not located on a shared disk in a Windows cluster configuration, then RTR behaves as a standalone RTR node and no use is made of cluster functionality.

2.18.3.2 Facility Role Definition

The computers (nodes) participating in RTR Facilities that are using the standby features must be configured with both a backend role and a router role.

2.18.3.3 RTR Home Directory

In a Windows cluster configuration, the RTR home directory must not be located on a shared SCSI disk. RTR creates lock files in the RTR home directory and the journal directory during normal operation. These are of the form N*.LCK or N*.BLK, and C*.LCK or C*.BLK. These files may be left in these directories after RTR has been stopped, but they will be reused once RTR is started again. There is no real need for a daemon to purge these files at system boot time.

2.18.3.4 Cluster Failover

The cluster failover group containing the disk share on which the RTR journal files are located must not have failback policy enabled. That is, if the failover group fails over to the secondary cluster node due to a primary server outage, the group must not fail back to the primary node once the primary node is available again. As long as RTR facilities have been defined in a cluster configuration, then the failover group with the journal device must not be manually failed over to the other cluster server by the cluster administrator. Failover should only occur at the discretion of the cluster failover manager software.

2.18.4 Unrecognized Clusters

Unrecognized or unsupported clusters have different behaviour than recognized or supported clusters.

The default behavior in unrecognized cluster systems is to treat them as non-clustered. However, RTR standby failover will still work. RTR will fail over to the standby server process if the active server process fails. This standby takeover also performs recovery. If it is only the active server process that failed, then RTR can still recover any uncertain transactions through the remote RTR process. If, however, the node itself becomes unavailable (from,

Starting and Setting Up RTR

2.18 Clustering Considerations for RTR Standby Servers

for example, an RTR crash, a node crash or a network crash) then the recovery process performs a journal scan to locate the journal of the failed node.

But unlike the case of a recognized cluster, RTR does not wait for the journal to become available. Instead, it changes to the active state and continues to process transactions. Any incomplete transactions in the failed node's journal will remain there; these transactions are not lost. They are eventually recovered when the failed node becomes active again, although their sequencing will be lost.

Partition Management

3.1 Overview

This section describes the concepts and operations of RTR partitions.

3.1.1 What is a Partition?

Partitions are subdivisions of a routing key range of values. They are used with a partitioned data model and RTR data-content routing. Partitions exist for each distinct range of values in the routing key for which a server is available to process transactions. RTR provides for failure tolerance by allowing system operators to start separate instances of partitions in a distributed network and by automatically managing the state and flow of transactions to the partition instances.

Partition instances support the following relationships:

- **Concurrency** - permits multiple server channels to be connected to an instance of a partition.
- **Standbys** - permits multiple instances of a partition to be distributed over the nodes of a cluster. A group of standby servers (a standby set) may have as many members as a cluster has nodes, or with some restrictions you may place a standby on any network node. At any one time, one member of the set is active while the others wait in standby mode to take over if the active member fails.
- **Shadows** - provide site disaster protection by allowing replication of transaction processing at a remote site. A pair of partition instances (or standby sets) cooperate to provide this replication, with provision for automatic recovery of a shadow member restarting after a failure.

The system operator can issue commands to control certain partition characteristics, and to set preferences concerning partition behavior.

Partition Management

3.2 Partition Naming

3.2 Partition Naming

A prerequisite for partition management is the ability to identify a partition in the system that is to be the subject of management commands. For this purpose, partitions have names, either by default, supplied by the programmer, or supplied by the system manager.

3.2.1 Name Format and Scope

A valid partition name can contain no more than 63 characters. It can combine alphanumeric characters (abc123), the underscore (_), and the dollar sign (\$). Partition names must be unique within a facility name and should be referenced on the command line with the facility name when using partition commands. Partition names exist only on the backend where the partition resides. You will not see the partition names at the RTR routers.

3.2.2 Default Partition Names

Partitions can receive automatically generated default names, in the form RTR\$DEFAULT_PARTITION, unless the name is supplied.

3.2.3 Programmer-Supplied Names

The application programmer can supply a name when opening a server channel with the `rtr_open_channel()` call. The `pkeyseg` argument specifies an additional item of type `rtr_keyseg_t`, assigning the following values:

- `ks_type = rtr_keyseg_partition` indicates that a partition name is being passed.
- `ks_lo_bound` should point to the null-terminated string to use for the partition name.
- `ks_hi_bound` must be NULL.

Using this model, the partition segments and key ranges served by the server are still specified by the server when the channel is opened.

3.2.4 System-Manager Supplied Partition Names

The system manager can supply partition names using the `create partition` system management command, or by using `rtr_open_channel()` flag arguments. The system manager can set partition characteristics with this command and applications can open channels to the partition by name. See Section 3.4 for an example of passing a partition name with `rtr_open_channel()`.

3.3 Life Cycle of a Partition

This section describes the life cycle of partitions, including the ways they can be created and their persistence.

3.3.1 Implicit Partition Creation

Partitions are created implicitly when an application program calls `rtr_open_channel()` to create a server channel, specifying the key segments and value ranges for the segments with the `pkeyseg` argument. Other partition attributes are established with the `flags` argument. Prior to RTR V3.2, this was the only way partitions could be created. Partitions created in this way are automatically deleted when the last server channel to the partition is closed.

3.3.2 Explicit Partition Creation

Partitions can also be created by the system operator before server application program start up using system management commands. This gives the operator more control over partition characteristics. Partitions created in this way remain in the system until either explicitly deleted by the operator, or RTR is stopped.

3.3.3 Persistence of Partition Definitions

RTR stores partition definitions in the journal and records for each transaction the partition in which it was processed. This is convenient when viewing or editing the contents of the journal (using the `SET TRANSACTION` command), where the partition name can be used to select a subset of the transactions in the journal. RTR will not permit a change in the partition name or definition as long as transactions remain in the journal that were processed under the current name or definition for the partition. If transactions remain in the journal and you need to change the partition name or definition, you can take one of the following actions:

- Start appropriate servers to complete processing of the transactions.
- Remove the transactions from the journal with the `SET TRANSACTION` command.
- Replace the RTR journal with the `CREATE JOURNAL/SUPERSEDE` command. Note that this will destroy any transactions remaining in the journal and should be done with caution.

Partition Management

3.4 Binding Server Channels to Named Partitions

3.4 Binding Server Channels to Named Partitions

For a server application to be able to open a channel to an explicitly created partition, the application passes the name of the partition through the `pkeyseg` argument of `rtr_open_channel()` call. It is not necessary to pass key segment descriptors, but if the application does, they must be compatible with the existing partition definition. You may pass partition characteristics through the `flags` argument, but these will be superseded by those of the existing partition.

```
RTR> create partition/KEY1=(type. . .) par_one
. . .
rtr_keyseg_t    partition_name;
partition_name.ks_type = rtr_keyseg_partition;
partition_name.ks_lo_bound = "par_one";

status = rtr_open_channel(..., RTR_F_OPE_SERVER,..., 1, &partition_name);
```

In summary, to fully decouple server applications from the definition of the partitions to be processed, write applications that open server channels where only the required partition name is passed. Leave the management of the partition characteristics to the system managers and operators.

3.5 Entering Partition Commands

Partitions can be managed by issuing partition commands directed at the required partitions after they are created. Partition commands can be entered in one of two ways:

- A command line processed by the RTR command line interface, for example
RTR> SET PARTITION
- Programmed using `rtr_set_info()`

Enter partition commands on the backend where the partition is located. Note that commands that affect a partition state only take effect once the first server joins a partition. Errors encountered at that time will appear as log file entries. Using partition commands to change the state of the system causes a log file entry.

3.5.1 Command Line Usage

Partition management in the RTR command language is implemented with the following command set:

- RTR> CREATE PARTITION
- RTR> SET PARTITION
- RTR> DELETE PARTITION

The name of the facility in which the partition resides can be specified with the /FACILITY command line qualifier, or as a colon-separated prefix to the partition name (for example Facility1:Partition1). Detailed descriptions of the command syntax are given in the Command Line Reference section of this manual, and are summarized in the following discussions. Examples in the following sections use a partition name of Partition1 in the facility name of Facility1.

3.5.2 Programmed Partition Management

Partition commands are programmed using `rtr_set_info()`. Usage of the arguments are as follows:

- `pchannel` supplies the address of a `rtr_channel_t` to receive the channel opened in the event of a successful call.
- `Flags` must be `RTR_NO_FLAGS`.
- `Verb` must be the value `verb_set` (from the enumeration `rtr_verb_t`).
- `Object` must be `rtr_partition_object`.
- `select_qualifiers` should identify the facility and partition, by name:

```
rtr_qualifier value_t select_qualifiers[ 3 ];
select_qualifiers[ 0 ].qv_qualifier = rtr_facility_name;
select_qualifiers[ 0 ].qv_value = "your_facility_name_here";
select_qualifiers[ 1 ].qv_qualifier = rtr_partition_name;
select_qualifiers[ 1 ].qv_value = "your_partition_name_here";
select_qualifiers[ 2 ].qv_qualifier = rtr_qualifiers_end;
select_qualifiers[ 2 ].qv_value = NULL;
```

- The `set_qualifier` list expresses the required change in partition behavior or characteristic.

The `rtr_set_info()` call completes asynchronously. If the function call is successful, completion is signaled by the delivery of an RTR message of type `rtr_mt_closed` on the channel whose identifier is returned through the `pchannel` argument. The programmer should retrieve this message by using `rtr_receive_message()`. The data accompanying the message is of type

Partition Management

3.5 Entering Partition Commands

`rtr_status_data_t`. The completion status of the partition command can be accessed as the `status` field of the message data.

3.6 Managing Partitions

A set of commands or program calls are used to manage partitions. Information on managing partitions is provided in this section.

3.6.1 Controlling Shadowing

The state of shadowing for a partition can be enabled or disabled. This can be useful in the following circumstances:

- Enabling site disaster protection for an application partition for the first time
- A recovery aid following prolonged outage of a former shadow site.

The following restrictions apply:

- Shadowing for a partition can be turned off only in the absence of an active secondary site.
- The active member must be running in remember mode.
- The command will fail if entered on either an active primary or secondary with a message to this effect.
- If entered on a standby of either the primary or secondary, the command is accepted but fails in the RTR router. This failure is recorded with a log file entry at the router.

Once shadowing is disabled, the secondary site servers will be unable to start up in shadow mode until shadowing is enabled again. Shadowing for the partition can be turned on by entering the command at the current active backend member or on any of its standbys.

```
RTR> SET PARTITION/SHADOW Facility1:Partition1
```

For further information, see the `SET PARTITION` command in Chapter 9.

To enable shadowing, program the `set_qualifier` argument of `rtr_set_info()` as follows:

```
rtr_qualifier_value_t  set_qualifiers[ 2 ];
rtr_partition_state_t  newState = rtr_partition_state_shadow;

set_qualifiers[ 0 ].qv_qualifier = rtr_partition_state;
set_qualifiers[ 0 ].qv_value     = &newState;
set_qualifiers[ 1 ].qv_qualifier = rtr_qualifiers_end;
set_qualifiers[ 1 ].qv_value     = NULL;
```

To disable shadowing, specify `newState` as `rtr_partition_state_noshadow`.

3.6.2 Controlling Transaction Presentation

Transaction presentation is the process of passing transactions to idle server channels for processing. While transaction presentation is active, new transactions are started on the first free server channel for the appropriate partition.

Use the `/SUSPEND` qualifier to the `SET PARTITION` command to halt the presentation of new transactions to servers on the backend where the command is entered. The command completes when the processing of all currently active transactions is complete. The optional `/TIMEOUT` qualifier specifies, as a number of seconds, the time that the command waits for completion. If the command times out, presentation of new transactions are suspended, but there still exist transactions for which servers have yet to complete processing. The operator must decide either to reenter the command and wait a further period of time, or resume the partition. Note that use of this command does not affect any transaction timeout value specified by RTR clients, so such transactions may encounter a timeout condition if the partition remains suspended.

The `/RESUME` qualifier restarts presentation of transactions to the server application channels.

The following examples show how to use the qualifiers:

```
RTR> SET PARTITION/SUSPEND/TIMEOUT=5 Facility1:Partition1
RTR>
RTR> SET PARTITION/RESUME Facility1:Partition1
```

For a more complete description, see the `SET PARTITION` command in Chapter 6.

To suspend transaction presentation on a partition with a timeout of 30 seconds, program the `set_qualifier` argument of the `rtr_set_info()` call as follows:

```
rtr_qualifier_value_t  set_qualifiers[ 3 ];
rtr_partition_state_t  newState = rtr_partition_state_suspend;
rtr_uns_32_t          ulTimeoutSecs = 30;

set_qualifiers[ 0 ].qv_qualifier = rtr_partition_state;
set_qualifiers[ 0 ].qv_value   = &newState;
set_qualifiers[ 1 ].qv_qualifier = rtr_partition_cmd_timeout_secs;
set_qualifiers[ 1 ].qv_value   = &ulTimeoutSecs;
set_qualifiers[ 2 ].qv_qualifier = rtr_qualifiers_end;
set_qualifiers[ 2 ].qv_value   = NULL;
```

Note that the timeout is an optional element. To resume transaction presentation, specify `newState` as `rtr_partition_state_resume`.

Partition Management

3.6 Managing Partitions

3.6.3 Controlling Recovery

The purpose of RTR automated recovery is to ensure the best possible consistency of application databases across a distributed computing environment. To achieve this, RTR relies in part on information stored in the journals of the participating backends. Should one or more of these systems be unavailable at recovery time, automated recovery may stall or fail awaiting availability of these systems and their journals. This enforces data consistency where transaction order is important, but can affect application availability.

For example, if a partition enters a wait state or fails, but has neither a local or remote journal, an operator can instruct RTR to skip the current step in the recovery process with the `/IGNORE_RECOVERY` qualifier. Since this command bypasses parts of the recovery cycle, use it with caution in cases where availability is valued over consistency in application databases. For a read-only database, transaction order will be unimportant.

The recovery cycle can also be manually restarted with the `/RESTART_RECOVERY` qualifier. This may be useful if the operator previously aborted automated recovery. Since this command can result in recovery of transactions from previously inaccessible journals, do not use this if your applications are sensitive to the order in which transactions are processed by the servers.

The following example shows how to use the qualifiers:

```
RTR> SET PARTITION/IGNORE_RECOVERY Facility1:Partition1
RTR>
RTR> SET PARTITION/RESTART_RECOVERY Facility1:Partition1
```

A complete description of the `SET PARTITION` command qualifiers can be found in Chapter 6.

To terminate the current recovery state, program the `set_qualifier` argument of `rtr_set_info()` as follows:

```
rtr_qualifier_value_t  set_qualifiers[ 2 ];
rtr_partition_state_t  newState = rtr_partition_state_exitwait;

set_qualifiers[ 0 ].qv_qualifier = rtr_partition_state;
set_qualifiers[ 0 ].qv_value = &newState;
set_qualifiers[ 1 ].qv_qualifier = rtr_qualifiers_end;
set_qualifiers[ 1 ].qv_value = NULL;
```

To restart recovery, specify `newState` as `rtr_partition_state_recover`.

3.6.4 Controlling the Active Site

RTR lets the system operator deploy a range of shadow and standby partitions in order to provide the desired degree of application resilience to failures. By default, RTR automatically manages the assignment of active and standby roles to the available partition instances. The operator can assign a relative priority to each backend on which a partition instance exists. Enter priority as a list of backend node names with the highest priority first in decreasing order, as shown in the following example:

```
RTR> SET PARTITION/PRIORITY_LIST=(BE1, BE2, BE3) Facility1:Partition1
```

Suspend transaction presentation before entering or changing the priority list.

Chapter 9 provides more information on the SET PARTITION command.

To set the partition backend priority list, program the `set_qualifier` argument of the `rtr_set_info()` call as follows:

```
rtr_qualifier value_t    set_qualifiers[ 2 ];
char      *szNodeList = "your,list,of,node,names,here"

set_qualifiers[ 0 ].qv_qualifier = rtr_partition_be_priority_list;
set_qualifiers[ 0 ].qv_value   = &szNodeList;
set_qualifiers[ 1 ].qv_qualifier = rtr_qualifiers_end;
set_qualifiers[ 1 ].qv_value   = NULL;
```

3.6.5 Controlling Failover

In a system employing shadows or standbys, there is a choice to be made in case the primary site fails. The `/FAILOVER_POLICY` qualifier to the SET PARTITION command lets the system operator select one of the following policies that RTR should pursue in selecting the new primary site in the event of a failure:

- `/FAILOVER_POLICY=STAND_BY` causes RTR to choose a standby partition of the failed primary (if any) to become the new primary. If there is more than one standby, the operator may also use the priority list feature (described above) to control which standby is preferred. Depending on the size of the journal of the failed primary, there will be a holdup in the processing of transactions while the journal is recovered. This is the default behavior.
- `/FAILOVER_POLICY=SHADOW` instructs RTR to make the active secondary (if any) the new primary.
- `/FAILOVER_POLICY=COMPATIBLE_PRE_V32` is a mode that will operate with configurations that contain RTR routers running versions of the software prior to V3.2. This mode will be automatically adopted if such routers exist in or join the configuration.

Partition Management

3.6 Managing Partitions

This mode assigns the active role to the first instance of a partition to be declared. If the system hosting this partition becomes unreachable, then the active role is assigned to the next partition instance to be declared, until the first partition's host becomes reachable again when the original roles are restored.

The time required to effect a failover and the subsequent impact on client response times will influence choice of failover policy. The time for standby takeover of a failed node's journal depends on the size of that journal, though failover to a shadow site is affected quickly. However, if the secondary shadow site has accumulated a backlog of transactions, they must be processed before any new transactions can be started. The choice will be determined by the characteristics of your application and configuration.

The following example shows use of the /FAILOVER_POLICY qualifier setting failover to a shadow server:

```
RTR> SET PARTITION/FAILOVER_POLICY=SHADOW Facility1:Partition1
```

The following example shows setting failover policy to a standby server:

```
RTR> SET PARTITION FacALPHA:AtoG/FAILOVER_POLICY=STAND_BY
```

You can view the policy that has been set with the SHOW PARTITION/FULL command.

For more information see the SET PARTITION command in Chapter 9.

To set the partition failover policy, program the set_qualifier argument of the rtr_set_info() call as follows:

```
rtr_qualifier_value_t  set_qualifiers[ 2 ];
rtr_partition_failover_policy_t newPolicy;

set_qualifiers[ 0 ].qv_qualifier = rtr_partition_failover_policy;
set_qualifiers[ 0 ].qv_value = &newPolicy;
set_qualifiers[ 1 ].qv_qualifier = rtr_qualifiers_end;
set_qualifiers[ 1 ].qv_value = NULL;
```

Legal values for newPolicy are:

- rtr_partition_fail_to_standby
- rtr_partition_fail_to_shadow
- rtr_partition_pre32_compatible

3.6.6 Controlling Transaction Replay

After a failure, RTR replays transactions stored in its journal as appropriate. RTR has implemented the capability of controlling transaction replay in cases where a killer message happens during a transaction replay preventing recovery from continuing normally. A killer message causes server availability to be lost because of the presence of a message capable of causing repeated server application failure during recovery. This is typically the result of an improperly handled condition or application programming error within the server itself. Under such circumstances it may be desirable to sidestep a particular transaction, maintain server operation, and manually process the transaction at some later time.

The RTR solution is to establish, for a given partition with the SET PARTITION command, the maximum number of retries for any given transaction presented during recovery. Once this limit has been exceeded, the offending transaction is removed from the recovery process and is written to the journal as an exception record. Subsequent processing of this transaction requires manual intervention by someone qualified to evaluate and correct the situation in both the application and in RTR. Once the application status is understood, the SET TRANSACTION command can be used to update the journal, thus ensuring that the final state of any manually transacted exceptions are accurately reflected in future recovery operations.

The recovery retry count is partition-specific, and applies to both local and shadow recovery operations. The default is no limit on the number of retries, which permits a killer message to bring down all available servers servicing a given partition.

The recovery retry count should be set before starting (or restarting) the application servers so that the limit is established prior to the start of recovery operations.

The following example shows how to set the retry count:

```
RTR> SET PARTITION/RECOVERY_RETRY_COUNT=3 Facility1:Partition1
```

See Chapter 9 for more information on the SET PARTITION command.

To set the partition transaction recovery limit, program the `set_qualifier` argument of `rtr_set_info()` as follows:

Partition Management

3.6 Managing Partitions

```
rtr_qualifier_value_t  set_qualifiers[ 2 ];
rtr_uns_32_t          newLimit = . . .;

set_qualifiers[ 0 ].qv_qualifier = rtr_partition_rcvy_retry_count;
set_qualifiers[ 0 ].qv_value = &newLimit;
set_qualifiers[ 1 ].qv_qualifier = rtr_qualifiers_end;
set_qualifiers[ 1 ].qv_value = NULL;
```

The retry limit applies to all transactions that have reached the voting stage on a server. If a server always dies before voting on a transaction, RTR aborts the transaction after the third try (“three-strikes and you’re out!”). For more information, see the description of /RECOVERY_RETRY_COUNT for the SET PARTITION command.

3.6.7 Partition Persistence

Partitions in RTR are designed to be persistent, remaining until explicitly removed during normal RTR processing. However, under certain conditions, relics of partitions can remain in the RTR journal. RTR automatically performs some cleanup of such records, but depends on the creation of the relevant facility to initiate this process. For example, in a test environment, many facilities are created for temporary use, with no intention of retaining those facilities. Because the creation of each facility may cause the creation of associated records for a partition in the RTR journal, creating many ad hoc facilities can cause the RTR journal to become filled. In such a case, when trying to create a new partition (or opening a new server channel), the error message NOMOREPRT may appear.

To correct this problem, the journal must be purged of these ad hoc entries. To purge the RTR journal of such unwanted transactions, use the DUMP JOURNAL command to verify the partition name and transaction ID of the unwanted transactions, and use the SET TRANSACTION command with the partition name and transaction ID to set the state to DONE. Recreate the facility with the CREATE FACILITY command.

3.7 Displaying Partition Information

Information on the definition and state of a partition is displayed with the SHOW PARTITION command, as seen in the following example. The information of interest in the context of partition management relates to the backend instance of the partition. See Chapter 9 for more information on the SHOW PARTITION command.

Partition Management

3.7 Displaying Partition Information

```
RTR> show partition/backend
```

```
Backend partitions on node BE1 at Wed Feb 24 15:07:50 1999
```

Partition name	Facility	State
RTR\$DEFAULT_PARTITION_16777217	RTR\$DEFAULT_FACILITY	active
RTR\$DEFAULT_PARTITION_16777218	RTR\$DEFAULT_FACILITY	active

For additional information on partition states, see Chapter 5.

Transaction Management

4.1 Overview

This section describes the concepts of RTR's transaction management capability.

The RTR transaction is the center of an RTR application, and transaction state is the property that characterizes a transaction's current condition. Whenever a transaction progresses from one stage to another, the transaction state is updated to reflect a transaction transition. Transaction states are maintained in memory. Transaction states are also stored in the RTR Journal for recovery purposes.

Three different states are used internally by RTR to keep track of transaction status.

- Transaction Runtime State
- Transaction Journal State
- Transaction Server State

These three states are very closely related. The Transaction Runtime State, also known as Transaction State, describes how a transaction progresses from an RTR role (FE, TR, BE) point of view. For example, a transaction can enter a stage in which its transaction state from an RTR frontend viewpoint is different from its transaction state from the viewpoint of an RTR router.

The Transaction Journal State describes how a transaction branch running on an RTR backend progresses from the RTR journal perspective. The Transaction Journal State and the Transaction Server State belong to each separate branch (participating partition) of the transaction. When a transaction branch changes state, its corresponding Transaction Journal State is updated and the new state, along with other information pertaining to this transaction, is stored in the RTR journal. The Transaction Journal State is primarily used by RTR to perform the recovery replay of a transaction after a failure, if necessary. An RTR frontend and router will not see this state. Note that because the Transaction Runtime State is not always stored immediately in the journal, the

Transaction Management

4.1 Overview

state in the journal may not always reflect the actual state of the transaction, but is kept updated by RTR. Table 4–1 describes the Transaction Journal States.

Table 4–1 Transaction Journal States

Transaction Journal State (by Branch)	Explanation of State
SENDING	Initial state of the transaction branch as the client sends a call to the server application. The RTR backend has received the transaction and RTR is waiting for votes.
VOTED	The servers have voted and the vote has been written to disk.
COMMIT	RTR has asked the servers to commit the transaction.
ABORT	RTR has asked the servers to roll back the transaction because of a “no” vote.
DONE	The servers have informed RTR that the transaction has been committed to the database. It is safe to FORGET the transaction.
PRI_DONE	The primary server has committed the transaction; the secondary may not have done so. This is the typical case of a REMEMBER transaction.
EXCEPTION	RTR asked the server to commit the transaction, but the server failed to commit it to the database. The transaction needs manual reconciliation.

The Transaction Server State describes transaction state as seen by a specific server, serving that branch of the transaction. RTR uses this state to determine if a server is available to process a new transaction or if a server has voted on a particular transaction. As with the Transaction Journal State, the Transaction Server State is only relevant at the backend.

RTR provides a set of comprehensive management utilities to help users closely monitor the flow of a transaction and all three types of states associated with that transaction. These utilities help users understand how a transaction migrates from one stage to another and help diagnose problems.

Use the `SHOW TRANSACTION` command to examine a transaction’s up-to-date status on frontend, router or backend roles. With this command, users can see all three types of transaction states of a particular transaction and also understand how the RTR journal and server applications perceive this transaction. When a transaction commits or aborts, all status associated with this transaction is removed from memory and can no longer be monitored by the command.

The `DUMP JOURNAL` command can be used to trace and review the flow of a transaction. The RTR journal saves all of the information about a transaction. This includes its transaction journal state and the transaction messages (records) received from the RTR client and sent to the server. The information is kept until a transaction is committed or aborted and all participants have been notified.

Use the `SET TRANSACTION` command to modify the current state of a transaction to a new state. This command can be used to circumvent an unexpected situation. For example, in a situation with shadow servers, the system administrator might decide not to replay (recover) all remembered transactions in an RTR journal after a failure. The `SET TRANSACTION` command could set specified transactions in a `PRI_DONE` or `REMEMBER` state to a `DONE` state and avoid the delay of transactions being remembered from a journal for fast recovery. The `SET TRANSACTION` command should only be used by experienced RTR system administrators as the command introduces the risk of corrupting or losing transactions if used incorrectly. It can be used on the backend only and the RTR log file must be turned on for this command.

Log file entries are made for all transaction state changes for debugging and auditing purposes.

4.2 Exception Transactions

When a server votes on a transaction, RTR expects the server to commit the transaction to the database when RTR makes the request. If for some reason the server cannot do so, the server has two choices:

- The server can exit the process, causing RTR to recover the transaction to another concurrent server channel or to a standby server. If the problem with committing to the database persists, it is possible that the subsequent attempts at recovering the transaction will cause other server processes to exit. This can cause the entire pool of servers to go away, thus affecting the availability of the application. You can avoid this by limiting the number of recovery attempts that RTR does for a specific transaction, using the `SET PARTITION/RECOVERY_RETRY_COUNT=nn` command. This limits the number of times the same transaction is recovered to a server, which subsequently crashes. The transaction can no longer be aborted once it is committed and is placed in an `EXCEPTION` state.
- The server application could use the `rtr_set_info()` function to directly change the state of a committed transaction to `EXCEPTION`. This avoids the need to crash in order to signal to RTR that something unexpected has happened to the transaction.

Transaction Management

4.2 Exception Transactions

EXCEPTION transactions can be inspected with the DUMP JOURNAL command. The final state of the transaction should say EXCEPTION.

4.2.1 Dealing with EXCEPTION Transactions

The system administrator must decide what to do with transactions that are marked EXCEPTION. There are two choices:

- Fix the environmental issue that was causing the server to crash, and then recover the transaction from the journal. To do this, the transaction state should be changed to COMMIT using the SET TRANSACTION command. When the server is restarted, RTR will recover this transaction.
- Manually apply the transaction to the database and remove the transaction from the RTR journal. To do this, the transaction state should be modified to DONE by using the SET TRANSACTION command. The transaction will be forgotten by RTR.

4.2.2 What EXCEPTION Transactions Mean to Data Integrity

EXCEPTION transactions keep the application available, although they cause some loss of data integrity. EXCEPTION transactions are considered committed by the initiator of the transaction, as well as by the other participants (such as the other shadow member). Therefore, subsequent transactions, which depend on the results of this transaction, could produce erroneous outcomes. In some applications, the erroneous outcomes do not matter, but in applications where the outcome does matter, the best approach is to allow the system administrator to manually intervene.

4.3 Transaction State Changes

There are eight valid state changes allowed for the SET TRANSACTION command. Attempting to change transaction state to a state that is not allowed produces an error message of %RTR-E-INVSTATCHANGE, Invalid to change from current state to the specified state. Table 4–2 identifies the valid state changes.

Transaction Management

4.3 Transaction State Changes

Table 4–2 Valid Transaction State Transitions

CURRENT STATE	NEW STATE			
	COMMIT	ABORT	EXCEPTION	DONE
SENDING		YES		
VOTED	YES	YES		
COMMIT			YES	YES
EXCEPTION	YES			YES
PRI_DONE				YES

All transaction states in Table 4–2 are RTR journal states. Use the RTR commands `SHOW TRANSACTION` or `DUMP JOURNAL` (you must stop the RTRACP to use this command) to determine the journal state for each transaction branch.

Four typical situations are listed below where transaction state changes by the system administrator are allowed.

- State `SENDING` changed to state `ABORT`.
 The server application, after receiving an `rtr_mt_prepare` message needs to access and lock the database record before calling `rtr_accept_tx()` for a particular transaction. If the record being accessed is locked for some reason, the application will experience a “hung” situation and cannot proceed. If the situation persists, the application will become unavailable. RTR detects such a deadlock, but intervention is probably required.
 Normally, this condition can be avoided by specifying a transaction timeout. However, if that is not the case, the system administrator can choose to abort the transaction with the `SET TRANSACTION` command. Internally, RTR will inform the router as well as all the other participating servers to abort this transaction in a consistent manner. Note that this may not be enough to correct the original condition with the database. The server application would still wait for the database to free up. Subsequent transactions could be sent to this server process, and be vulnerable. The real reason for the lockup should be investigated and corrected.
- State `VOTED` changed to state `COMMIT`.
 A transaction branch could be in a `VOTED` state when a server application running on the backend may have been separated from the rest of participating servers after casting the `VOTE` for a multi-participant transaction. Another way this could happen is that at least one of the

Transaction Management

4.3 Transaction State Changes

other participants in a distributed transaction has failed to cast its VOTE (by calling `rtr_accept_tx`).

As long as there is a router coordinating the transaction, RTR will not allow the state of the transaction to be modified from VOTED to COMMIT in order to prevent the possibility of data inconsistency. This can happen because RTR is still in the middle of determining the final state for the transaction. However, it is possible to modify the state to ABORT, as explained in the next section.

If the backend is not connected to a coordinating router, the other servers may have already committed the transaction but not “forgotten” it. As far as the application is concerned, this global transaction is committed and all changes have been committed to the underlying database on the different sites. However, the local transaction branch is still in VOTED state in the RTR journal. You can use the command to manually commit the local transaction branch. This results in the transaction being recovered to a server during the next recovery cycle.

As mentioned earlier, this command is only applicable if there is no coordinating router running, (that is, the backend is separated from the rest of the RTR network). If this is not the case, RTR rejects the command with the error message `RTR-E-SETTRANROUTER`, indicating that a coordinating router is still available.

Note

This operation could lead to data inconsistency, if used injudiciously, and should only be used after careful research.

- State VOTED changed to state ABORT.

As previously explained, a transaction can be stalled in a VOTED state in one or more of the following situations.

- There is a distributed deadlock (only possible with multi-participant transactions and multiple simultaneously active transactions).
- One participant has voted, but another participant has not voted (for example, waiting for the database record to become accessible).
- The transaction is not currently active, and is a candidate for recovery. The transaction is probably a multi-participant transaction and the final journal state for the local branch is VOTED. The transaction outcome cannot be determined without consulting the journal from the other participants.

Transaction Management

4.3 Transaction State Changes

Whatever the cause, this transaction ties up the system resources and prevents other transactions from running. Should the system administrator decide to abort the transaction using the SET TRANSACTION command, RTR sends a request-to-abort message to all the participants (transaction branches) to abort each transaction branch. After the abort, RTR presents a `rtr_mt_rejected` message to each server with a status indicating that "TX was aborted by Set Transaction operation". If the coordinating router is available, a race condition is possible, in that the transaction coordinator might be trying to commit the transaction at the instant that the operator was attempting to abort the transaction. Under this scenario, RTR may not allow the abort to proceed, if the coordinating router has already decided to commit the transaction. An operator log message on the router will be written to warn the administrator of this situation.

- State COMMIT changed to state DONE.

An example of this state change is where a server crashed while performing an SQL commit immediately after receiving an `mt_accepted` message. The transaction is in COMMIT state as recorded in the RTR journal, but RTR considers this an uncertain transaction and will try to recover this transaction (unless limited by the partition's `RECOVERY_RETRY_COUNT` parameter). If a determination can be made that the transaction is truly committed in the underlying database, there is no reason to allow RTR to recover or replay this transaction to another server. To forget such transactions, the state should be changed from COMMIT to DONE. For single participant transactions, a journal state of VOTED really means COMMIT, because there is no reason for RTR not to commit a transaction that has one branch that is ready to commit.

After the SET TRANSACTION command is executed, use the DUMP JOURNAL command to verify the result.

4.4 Command Line Examples

The following is an example of the SET TRANSACTION command:

```
RTR> start rtr
RTR> set log/file=settran
RTR> set transaction/state=PRI_DONE/new_state=DONE/facility=Facility1/_
_RTR> partition=Partition1 *
```

This example would set all transactions with the current state of `PRI_DONE` (remember) to `DONE` on the facility `Facility1` and the partition `Partition1`. The log file, `settran`, would record the transaction state changes. The changes could be viewed with the SHOW TRANSACTION command or the DUMP

Transaction Management

4.4 Command Line Examples

JOURNAL command. In a shadow recovery situation this would clear the journal of remember transactions and provide for a quick turnaround of the shadow site.

The following example shows how RTR commands monitor and manipulate three different transaction states. Consider a scenario where a distributed transaction accesses two RTR partitions. The multiple-participant distributed transaction would have two transaction branches accessing different RTR partitions, say part1 and part2, respectively.

The client commits the transaction and calls `rtr_accept_tx()` which prompts RTR to start the two-phase commit protocol. RTR sends a prepare message to the two participants. Upon receiving the prepare message (`mt_prepare`), one of the server applications is ready to commit and casts its vote by calling `rtr_accept_tx()`. RTR writes a VOTE record in the RTR journal and sends the vote message back to the router. However, due to an unexpected defect in the application software, the second server has not sent its VOTE message back to the RTR router. Thus, the transaction is stalled in the second server.

To examine this situation, an RTR system administrator should first use the **SHOW TRANSACTION/BACKEND** command on the backend node to analyze the transaction's status. As shown in the following example, the transaction runtime state is **RECEIVING**, indicating the distributed transaction is not yet committed. The server states for the transaction branches are **VOTED** and **VREQ** respectively, indicating that one of the transaction branches has been voted by the associated server whereas the other transaction branch is still in "Vote Request" state (**VREQ**). The journal states for the transaction branches are **VOTED** and **SENDING**, indicating that one transaction branch has voted and its **VOTED** record was written in the RTR journal. The other transaction branch's journal state is **SENDING**, indicating that transaction branch is still in the process of processing a message from the client and it has not yet advanced to the **VOTED** state. The journal states for the transaction branches that are recorded in the RTR journal are consistent with their server states.

A transaction branch's journal state is persistent and is therefore used by the **SET TRANSACTION** command to change a transaction's state. The **DUMP JOURNAL** command is also useful to examine each transaction branch's journal state.

Transaction Management

4.4 Command Line Examples

Backend transactions on node nodea at Mon Mar 13 16:02:42 2000

```
Tid:          3ad01f10,0,0,0,0,3ad01f10,a08730b4
Facility:          test
Frontend:          nodea      FE-User:          tu.7006
State:            RECEIVING  Start time: Mon Mar 13 16:00:08 2000
Key-Range-Id:    16777216,16777217  Router:          nodea
Invocation:      ORIGINAL,ORIGINAL  Active-Key-Ranges: 2
Recovering-Key-Ranges: 0            Total-Tx-Enqs:    2
Server-Pid:      7006,7006          Server-State:      VOTED,VREQ
Journal-Node:    nodea.com,nodea.com  Journal-State:     VOTED,SENDING
First-Enq:       1,2                Nr-Enqs:          1,1
Nr-Replies:      0,0
```

As previously described in this scenario, the transaction is stalled in one of the servers. To resolve this situation, use the RTR SET TRANSACTION command to abort this transaction. Change either one of the transaction branch's journal state to ABORT as shown in the following example:

```
RTR>set transaction/new=abort/state=voted/facility=test/partition=part1
%RTR-S-SETTRANDONE, 1 transaction(s) updated in partition part1 of
  facility test
```

or

```
RTR>set transaction/new=abort/state=sending/facility=test/partition=part2
%RTR-S-SETTRANDONE, 1 transaction(s) updated in partition part2 of
  facility test
```

See Chapter 9 for detailed information on these commands.

Server Shadowing and Recovery

With RTR **shadowing**, your system can recover from a site disaster without the need for special coding within your application program.

A database is said to be shadowed when two copies of the same database are deployed on separate nodes at two different locations, typically two different sites. Each location maintains a copy of the database used by the server application, and RTR keeps the database copies synchronized. Shadow site configurations can contain two nodes at separate sites, two nodes in a cluster, or two clusters at separate sites. When setting up a shadow configuration for two nodes in a cluster, the syntax must explicitly state that the nodes are not to be standby nodes.

Concurrent servers handle *similar* transactions, (that is, in the same key range but not the same transactions). Standby servers do not handle transactions at all (for the given key range) and shadow servers handle the *same* transactions.

5.1 Primary and Secondary Partition States

There is a concept of primary and secondary states for the shadow server pair, although in most cases this is transparent to the user when the processing is the same on both sites.

The assignment of primary and secondary states to partitions can be managed by the partition priority list or left to RTR. If left to RTR, initial role assignment is arbitrary, in that the first server of a shadow pair to start is put in the primary state and the second, in the secondary state. The adopted states may change, as servers come and go. RTR needs to determine which server is in the primary state before presenting a transaction to the server in the secondary state.

The state of a backend partition changes depending on the status of the partition on the backend. Some states are part of normal operation while some may indicate a problem to be resolved. Table 5–1 describes partition states you may see when running RTR. When using the RTR Explorer, each partition

Server Shadowing and Recovery

5.1 Primary and Secondary Partition States

state has a unique icon. (See the RTR Explorer interface to view these icons, some of which are animated.)

Table 5–1 RTR Partition States

Name	Description
Active	The backend is actively accepting new transactions for this partition; one or more other backends may have other instances of this partition.
Catchup or Catching Up	The partition is recovering the last outstanding transactions from the shadow site for this partition before accepting new transactions. During catchup, RTR is doing shadow synchronization while the primary active partition temporarily pauses transaction processing so the shadow partition can 'catch up' by processing the last outstanding transactions. Once the shadow partition has processed all transactions, it becomes either the primary or secondary backend and the remote shadow partition then resumes transaction processing.
Local Recovery	The backend is recovering outstanding transactions found in the journals for this facility. The backend must complete local recovery before accepting new transactions. This partition state occurs when a channel is first opened for the partition by a server, or when the backend is part of a standby configuration when the backend assumes the active role. The RTRACP searches its local journal for all recoverable transactions, and plays those transactions to the server applications. If the backend is configured as a standby, it reads the journals from its standby peers. Once all recoverable transactions have been played to the applications, the backend begins to process new transactions. In general, the larger or more complex the journal, the longer it takes for a backend to complete local recovery.
Local Recovery Complete	The partition quickly enters and exits this temporary state during local recovery.

(continued on next page)

Server Shadowing and Recovery

5.1 Primary and Secondary Partition States

Table 5–1 (Cont.) RTR Partition States

Name	Description
Local Recovery Failed	The backend was recovering outstanding transactions in journals for this facility, but the partition could not recover all the transactions. For example, in a standby configuration, a backend that cannot access the journal on the remote backend would enter this state. Manual intervention may be required.
Local Recovery Incomplete	Local recovery has completed processing the journals of one or more backends in the facility, but the journals of some backends are yet to be processed. The partition quickly enters and exits this temporary state during local recovery.
No Servers	There are no server applications with channels to the partition, so the backend is not available to accept new transactions for this partition. The partition exits this state once a server opens a channel for the partition.
Primary Active	The backend is receiving new transactions for this partition and forwarding them to servers. It is the designated primary of a two-computer configuration providing shadowing for the partition. Once committed on the primary site, transactions become eligible for processing on the shadow secondary site.
Remember	Shadowing is in effect for this partition, but only one active partition instance is currently accessible. The backend thus records all new transactions for this partition in its journal. When a second active instance becomes available, it will receive the journaled transactions through shadow recovery.
Rundown	The backend is shutting down the partition. This state occurs when the last server with an open channel to the partition exits or closes the channel.
Secondary Active	The backend is receiving transactions committed on the primary active node for this partition. If the primary active node fails, the backend assumes the primary role and continues to process transactions without interruption.

(continued on next page)

Server Shadowing and Recovery

5.1 Primary and Secondary Partition States

Table 5–1 (Cont.) RTR Partition States

Name	Description
Shadow Recovery	<p>The partition is recovering outstanding transactions from the shadow site for this partition. During shadow operation, if one partition fails (for example, because of link disconnects or node failure), the partition on the shadow backend remembers all transactions from that point on. When the partition is restored, the backend copies and replays all remembered transactions from the shadow site, and is in shadow recovery state. To preserve transaction order, the backend does not accept new transactions for this partition until shadow recovery is complete. However, the primary backend continues to process transactions to maintain service continuity.</p>
Shadow Recovery Complete	<p>The partition quickly enters and exits this partition state during shadow recovery.</p>
Shadow Recovery Failed	<p>The partition could not recover its outstanding transactions from the shadow site. This might occur if a partition is in shadow recovery but the remote shadow site becomes inaccessible. Restoring access to the remote shadow site enables RTR to continue with shadow recovery. To maintain transaction order, the backend does not accept new transactions for this partition until shadow recovery completes. Manual intervention may be required.</p>
Shadow Recovery Incomplete	<p>The partition quickly enters and exits this partition state during shadow recovery.</p>
Standby	<p>This backend partition instance is a member of a redundant standby partition deployed over two or more computers. This instance is waiting to become the active member before accepting new transactions for the partition. Transactions are currently being processed on the active member of the set on another computer. If the active partition instance becomes unusable, RTR automatically promotes one of the standby instances to the active role.</p>
Waiting for Quorum	<p>The partition is waiting for backend quorum to be established for its facility. Failure to achieve quorum indicates either insufficient connectivity or an inconsistent facility definition across member systems.</p>

(continued on next page)

Server Shadowing and Recovery

5.1 Primary and Secondary Partition States

Table 5–1 (Cont.) RTR Partition States

Name	Description
Waiting for Router OK	The backend is waiting for a response from a router before accepting new transactions for this partition. The partition should stay in this state only temporarily. If the state persists, then check if there is a configuration or connectivity problem.

5.2 Automatic Features

A shadow site has an identical copy of the customer's database.

Transactions are sent by RTR to both sites. RTR ensures that they are processed by the servers in the same order on each site (unless transactions are defined as independent), so that both copies of the customer database remain up to date.

A transaction is sent to the secondary site only after the primary has accepted it, or if the primary fails before being asked to vote.

RTR suppresses replies and broadcasts issued by the secondary shadow server.

5.2.1 Shadow Events in Partitions

RTR provides the following shadowing events:

RTR_EVTNUM_SRPRIMARY	Server is in primary mode
RTR_EVTNUM_SRSTANDBY	Server is in standby mode
RTR_EVTNUM_SRSECONDARY	Server is in secondary mode
RTR_EVTNUM_SRSHADOWLOST	Server has lost its shadow partner
RTR_EVTNUM_SRSHADOWGAIN	Server has gained its shadow partner
RTR_EVTNUM_SRRECOVERCMPL	Server has completed recovery

The shadow events are delivered with no special status and no data. They are delivered only to the servers whose state has changed.

A server receives RTR_EVTNUM_SRPRIMARY under the following circumstances:

- On initial startup if servers for the key range are not already running on other nodes
- If the server had previously been standby and the previous primary has failed

Server Shadowing and Recovery

5.2 Automatic Features

- If the server had previously been shadow secondary and the previous primary has failed

A server receives `RTR_EVTNUM_SRSTANDBY` when it starts up and servers already exist for the same key range on another node in the same cluster.

A server receives `RTR_EVTNUM_SRSECONDARY` when it starts up and a shadow primary set of servers exist elsewhere.

A server receives `RTR_EVTNUM_SRSHADOWLOST` if it is running as primary and the secondary goes away.

A server receives `RTR_EVTNUM_SRSHADOWGAIN` if it is running as primary and a secondary node starts up.

A server receives `RTR_EVTNUM_SRRECOVERCMPL` when it has finished doing recovery operations and is ready to start processing new transactions.

5.3 RTR Journal System

The RTR journal is used for the following purposes:

- RTR stores data about a transaction so that if the backend processing a transaction fails for any reason, another backend can transparently continue from where the previous server failed (if it is able to access the same database and journal) (assuming an environment where both backends can access the journal disk).
- RTR also stores data about transactions when a shadow site is known to be missing. In this case, RTR stores all transaction data which can result in a database update. The RTR journal stores this data in the journal file accessible from the backend until the secondary shadow site is available again. RTR then transparently replays this data to the shadow site, after which the data is deleted from the journal.
- Partition information

5.4 Shadow Site Failure and Journaling

If a shadow site fails, RTR allows transactions to continue to be processed on the remaining site. The transactions processed by the remaining server or servers are retained by the primary server in its journal; when the failed site restarts, these transactions are sent to this site as part of a shadow-recovery operation, thus bringing the failed site back up to date.

Server Shadowing and Recovery

5.4 Shadow Site Failure and Journaling

The overhead required when calculating journal size comes from internal journal data (block stamping) of approximately 3%. In addition, there is internal transaction data per (client to server) transactional message, and some further data per transaction (concerning voting and transaction completion).

Also, RTR prevents further transactional data from being written to the journal when it is nearly full, but continues to allow deletes from the journal (deletes also cause data to be written to the journal). Ten segments are held in reserve for storing information about deleted transactions even when RTR cannot accept further transactions because the journal is full.

Caution

If the journal disk becomes full, transactions are aborted until the shadow partner restarts and empties the journal of transactions to be replayed.

5.5 Performance

The performance of a shadow pair compares with a transaction that spans two nodes, with the addition of one extra protocol message which is required to ensure that the transactions are presented in the same order.

RTR does not have to wait for the secondary shadow server to complete its processing. It only needs to know that the primary has committed the transaction and that the journal file of the secondary shadow server contains the final vote status.

The two partners in a shadow pair should be connected with sufficient bandwidth to allow for the large amounts of data which may need to be transferred during a shadow catchup operation.

5.6 Shadows in Action

The first node on which a shadow backend for a particular key range starts is arbitrarily designated by RTR to be the primary site for that key range unless a priority list has been defined.

Initially each RTR backend searches its journals to find any recoverable transactions left over from a previous invocation of the backend. Once these have been processed (or RTR determines that no such transactions exist), the backend becomes active and available to handle new transactions sent by clients/frontends.

Server Shadowing and Recovery

5.6 Shadows in Action

While no other backend node for this key range is available, the backend runs in REMEMBER mode. RTR saves transactions processed on this site in the RTR journal (together with the order in which they should be committed), so that when the other-site backend starts, they can be sent to this site.

When a backend starts on a second site, it begins processing the transactions saved in the primary site's journal. These are deleted from the journal as they are processed. When the second site backends have caught up, the second backend enters SECONDARY ACTIVE state and the original site backends enter PRIMARY ACTIVE state. In this mode, new transactions are sent to both sites in parallel. They are executed first on the primary site, and shortly afterward on the secondary site in the same order. The primary site commits transactions as soon as it knows that the secondary site has hardened (i.e., written to the journal) the order in which the transaction is to be committed.

If a failure occurs at this point, the remaining site executes a short cleanup operation. After completing the cleanup operation and determining that the other site is really down, it reverts to the REMEMBER state and continues processing new transactions autonomously, saving the transaction information in its journal for when the other site restarts.

The execution order is determined for transactions issued to concurrent servers on a particular node by recording the order in which the individual servers issue `rtr_accept_tx()` calls. RTR knows that at the time a correctly written server application calls `rtr_accept_tx()`, it has already accessed (and therefore locked) any database records it uses, and that it will release these records after RTR causes the `rtr_accept_tx()` call to complete. Any conflicting transaction would not be able to issue `rtr_accept_tx()` concurrently. Therefore a correct serialization order for issuing the transactions on the shadow site can be determined.

Transactions can also use the `/INDEPENDENT` or `/READ_ONLY` flag to tell RTR that their order is not important and transactions need not be recovered serially.

5.7 Server States

The current state of a server can be examined using the `SHOW SERVER/FULL` command. For example,

Server Shadowing and Recovery 5.7 Server States

```
RTR> show server/full  
Servers:
```

```
Process-id:          13340      Facility:          RTR$DEFAULT_FACILITY  
Channel:             131073     Flags:            SRV  
State:               active❶    Low Bound:       87 13  
High Bound:          87 13     rcpnam:          "RTR$DEFAULT_CHANNEL"  
User Events:         0         RTR Events:      0  
Partition-Id:       16777216
```

```
Process-id:          13340      Facility:          RTR$DEFAULT_FACILITY  
Channel:             196610     Flags:            SRV  
State:               active     Low Bound:       88 13  
High Bound:          0f'       rcpnam:          "CHAN2"  
User Events:         0         RTR Events:      0  
Partition-Id:       16777217
```

❶ Server state

Figure 5–1 shows the backend server states that can occur and that appear in the State: field.

Server Shadowing and Recovery

5.7 Server States

Figure 5-1 Backend Server States

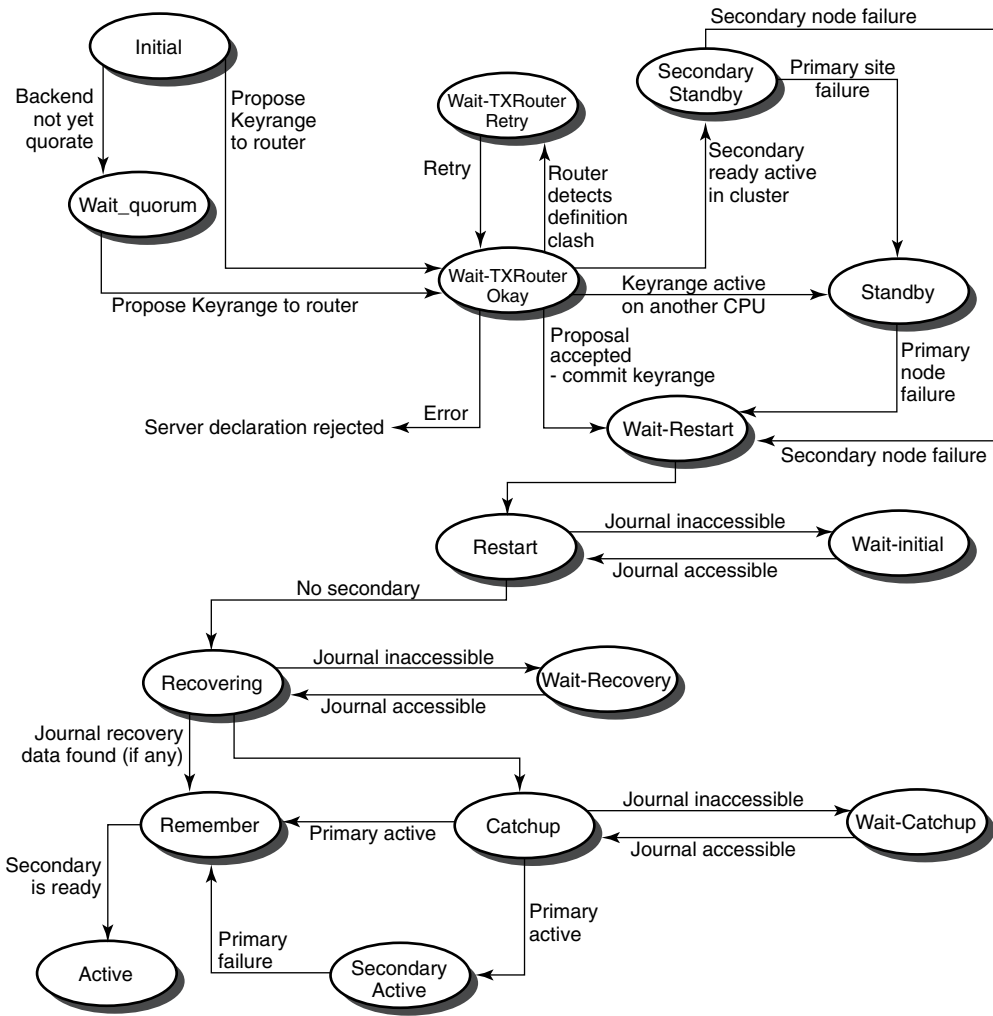

VM-0854A-AI

5.8 Client States

The current state of a client process can be examined using the SHOW CLIENT/FULL command. For example,

```
RTR> show client/full
Clients:
Process-id:          13340      Facility:          RTR$DEFAULT_FACILITY
Channel:             458755     Flags:            CLI
State:               declared❶  rcpnam:          "CHAN3"
User Events:         255        RTR Events:      0
```

❶ Client state

Figure 5–2 shows the client states that can occur and that appear in the State: field.

Figure 5–2 Frontend Client States

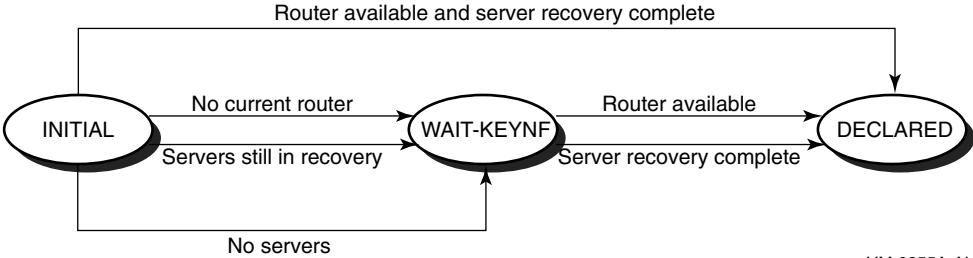

VM-0855A-AI

5.9 Partition States

The current state of a partition can be examined using the SHOW PARTITION/FULL command on the routers and the backends. Using the /ROUTER qualifier shows the states as seen from the routers, and using the /BACKEND qualifier shows the states as seen from the backends.

Server Shadowing and Recovery

5.9 Partition States

Router partitions:

```
RTR> show partition/router/full
```

```
Facility:      RTR$DEFAULT_FACILITY      State:      ACTIVE①
Low Bound:    0                          High Bound: 4294967295
Failover policy: fail_to_standby
Backends:    node10
States:      active②
Primary Main: node10      Shadow Main:
```

① Router state

② Backend state

Backend partitions:

```
RTR> show partition/backend/full
```

```
Partition name:      RTR$DEFAULT_PARTITION_16777217
Facility:      RTR$DEFAULT_FACILITY      State:      active①
Low Bound:    "aaaa"                      High Bound: "mmmm"②
Active Servers: 0                          Free Servers: 1③
Transaction presentation: active
Txns Active: 0
Failover policy: fail_to_standby      Key range ID: 16777217④
```

```
Partition name:      RTR$DEFAULT_PARTITION_16777218
Facility:      RTR$DEFAULT_FACILITY      State:      active
Low Bound:    "nnnn"                      High Bound: "zzzz"
Active Servers: 0                          Free Servers: 1
Transaction presentation: active
Txns Active: 0
Failover policy: fail_to_standby      Key range ID: 16777218
```

① Backend server state

② Key range for partition

③ Server application channels that are available

④ Key range or partition identification

Figure 5-3 shows the partition states that can occur and that appear in the State: field.

Figure 5-3 Router Partition States

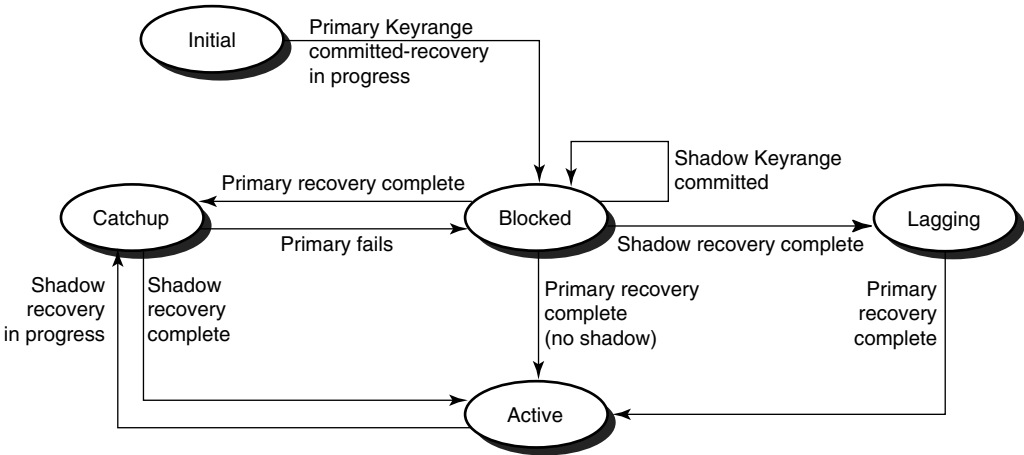

VM-0856A-AI

Performance Management

RTR enables you to capture RTR counters and display them for monitoring with the standard Windows Administrative Tools Performance utility.

RTR V4.2 ECO3 and later versions running on Microsoft Windows can be configured to expose RTR performance information as Windows performance objects. The features of this innovation include:

- Using a single Windows system to provide coverage of:
 - multiple RTR installations
 - all RTR platforms
 - prior RTR versions
- Has very low impact on monitored systems
- Out-of-the-box RTR performance monitoring using the standard Windows performance tool, allowing:
 - performance logs and alerts
 - system operators to define and save multiple system views
 - performance charts, integrated with RTR Manager web pages
- Allows viewing RTR performance information from any seat in your Windows network.
- Provides an integration point for RTR performance data with other enterprise management products such as HP OpenView.

Figure 6–1 illustrates use of this tool with RTR Manager.

Performance Management

6.1 Performance Counter Hosting

Figure 6–1 Performance Chart in RTR Performance Monitor

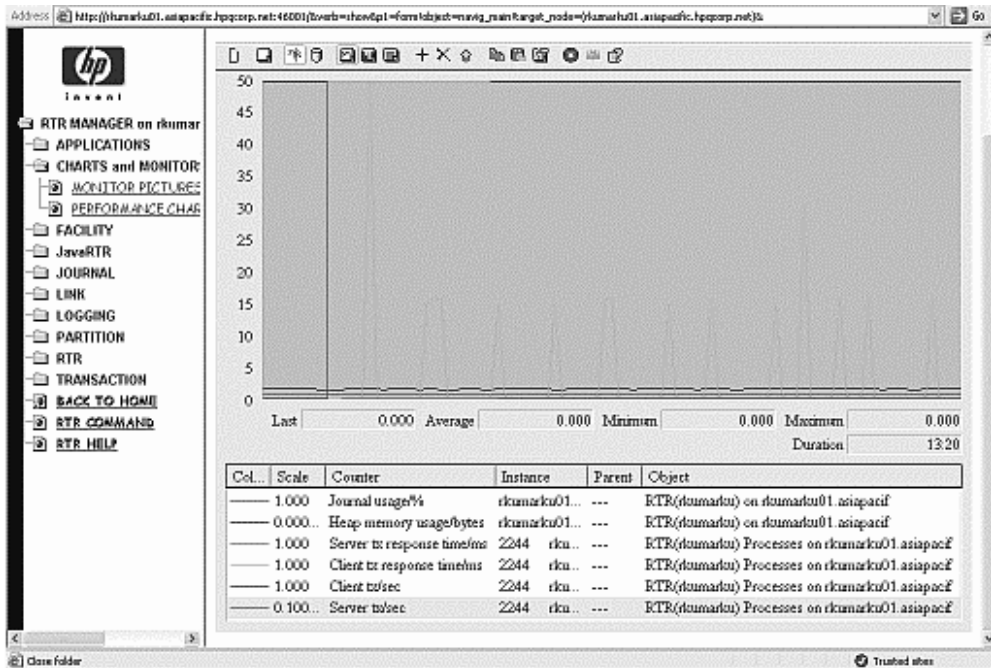

VM-1104A-AI

6.1 Performance Counter Hosting

To monitor performance using this tool:

1. Establish which machines are to be the *counter hosts* and which nodes are to be the *target machines*. RTR must have been installed on all these machines.
2. Start counter hosting by executing the RTRCounterUpdate command on the counter host machine (a Windows system that meets the counter host requirements, see Section 6.2.1). This command causes the counter host to gather data from the target machines.
3. Gather the desired data, using specific performance counters that you determine are those to identify, review, and track performance.
4. View performance graphs using the Performance Monitor/Performance Chart selections from RTR Manager.

6.2 Terminology

The following terms define the components used for direct performance monitoring.

6.2.1 Counter Host

A **counter host** must meet the following criteria:

- It must be a Microsoft Windows 2000 family (2000, XP) machine that has RTR installed.
- It must be configured to collect performance information from one or more RTR target machines.
- The Microsoft .NET Framework must be installed. The redistributable for this can be obtained as a free download from Microsoft.
- rsh access to the target machines is required to initiate network connections for RTR remote commands.
- Microsoft Internet Explorer must be installed.

RTR need only be installed; it can be on a Windows node defined with any RTR role. The counter host can also be on an HP machine running HP OpenView, which can handle Windows performance tools.

6.2.2 Target Machines

A **target machine** is any RTR node in your network which you wish to include in your RTR performance counter coverage. Coverage is configured by including the name of the target machine on the command line used to start the counter host. A target machine must accept RTR remote commands from any counter host specifying the machine as a target. This requires TCP connectivity and permission for the user on the counter host to operate RTR and use rsh for remote access on all target machines. Target machines may be of any RTR platform type, that is, not just Windows.

6.3 Starting and Stopping Performance Counter Hosting

Start performance counter hosting by using the RtrCounterUpdate program on the counter host machine at the Windows/DOS prompt. The command line for this program is:

```
RtrCounterUpdate [-h] [-c counter-filename] [-i interval-ms] [node1 node2...]
```

where:

-h displays a help message

Performance Management

6.3 Starting and Stopping Performance Counter Hosting

`-c counter-filename` specifies a counter-collection definition file (default: `PerfCtr.ctr`). This file is an ASCII file and must reside on the counter host. The default file is supplied with the RTR kit.

`-i interval-ms` specifies the wait interval in ms (milliseconds) after each sampling (default: 500 ms).

`[node1...]` is the target node list containing the nodenames of the target machines (default: the local node). There is no practical limit to the number of nodes you can specify.

For example:

```
RtrCounterUpdate -i 1000 OpenVMS_host Tru64_host Windows_host
```

As shown in the example, target machines of all platform types are supported, provided they meet the requirements listed previously.

Once it has received the first counter sample, the update program installs the necessary Windows performance objects. The following objects are installed for each target machine being hosted:

- RTR on <target_machine_name>
- RTR Links on <target_machine_name>
- RTR Facilities on <target_machine_name>
- RTR Processes on <target_machine_name>
- RTR Partitions on <target_machine_name>

Each performance object contains several performance counters that are useful metrics of RTR performance and configuration. Instances of each counter are provided for each corresponding RTR object found on the target systems.

The `RtrCounterUpdate` program exits if any user input from the terminal is entered.

6.4 Using Windows Performance Counters

Performance counters can be used in the following ways:

- Access the Windows system monitor as the Performance Chart page of the RTR Manager.

This page is in the monitoring collection. Note that this page is only available if viewing RTR manager web pages using Microsoft Internet Explorer on the Windows 2000 or Windows XP platform, and a current performance counter host exists for the computer being monitored. The default chart contains counters of general interest, but you can add other counters to suit your requirements using the Add Counters dialogue.

Performance Management

6.4 Using Windows Performance Counters

- The Windows Performance tool can also be accessed through the Administrative Tools folder of the Windows control panel. Since this is a standard Windows application, please refer to Windows help for additional information on its use.

To add RTR performance counters to any tool configuration, use the Add Counters dialogue. Scroll down the performance object list box and select the desired RTR object and target node, then choose from the available counters and instances in the remainder of the dialogue. Use only the “Select counters from computer” option to connect to other counter hosts. You cannot connect directly to non-Windows targets.

Using this tool, you can define and save chart views of RTR performance counters, configure performance logs, and enable alerts triggered by RTR performance criteria.

6.5 Ensuring your Data Are Valid

When monitoring performance, you will want to ensure that your data are valid and current. See the next sections on how to eliminate the following problems:

- counter host unknown
- stale performance data
- mismatched sampling and display rates
- invalid instance names

6.5.1 Counter Host Unknown

To generate a web page allowing access to the performance counters for a system, the Windows system hosting the counters must contact the RTR HTTP web server machine with registration information. This registration is automatic, and occurs periodically. The message “no counter host for target ...” indicates that no such registration can be found on this web server for the indicated target machine.

The most likely reason for this condition is that no performance counter host has been configured to provide coverage for the target in question. For information on starting up counter hosting, see Section 6.3.

This message may also be observed if the RTR HTTP server has only recently been started and asked to display the performance chart page before receiving the necessary registration information. Since counter registration occurs automatically and periodically, just reload the page later.

Performance Management

6.5 Ensuring your Data Are Valid

6.5.2 Stale Performance Data

Performance counter hosts register their activity with covered target machines so that RTR management web pages may be generated to display the performance counter charting application. A warning appears if this registration data is more than 10 minutes old. Check that the performance counter host is functioning correctly.

6.5.3 Mismatched Sampling and Display Rates

The data in the Windows performance objects is periodically refreshed as new samples are taken from the target systems. The rate at which this information is updated depends on both the value of `interval_ms` specified when configuring the performance counter host, and the latency of the network connecting the host and target. Latency can be minimized by placing hosts near the targets for which they provide coverage.

The default setting of the Windows performance tool charting function is to update the screen display every second. For performance counters that display as a rate of change per second, this will lead to erratic estimates of the rate in the displayed data, including false indications of zero rate, due to the mismatch in display and data update rates. HP recommends that the display update rate be set to no less than 10 times the data sampling rate. For example, if the performance counters display per second, set the screen update interval at 10 seconds.

CPU usage on the counter host is inversely related to the value of `interval_ms`.

6.5.4 Invalid Instance Names

Where possible, the instance names of the Windows performance counters are the same as the underlying RTR objects being measured. However, not all names allowed by RTR are valid Windows counter instance names. Names containing the '\$' character are modified by replacing that character with a hyphen for use in Windows.

6.6 Removing RTR Counters from the Registry

The Windows performance counters installed by RTR can be removed by deleting the RTR Windows registry key entries from the following:

```
HKEY_LOCAL_MACHINE/SYSTEM/CurrentControlSet/Services
```

Troubleshooting RTR Applications

This chapter contains information useful for analyzing performance aspects of RTR, especially in large configurations.

To manage remote nodes, you must have either proxy accounts or rsh access to them. Use RTR remote commands to manage remote nodes.

You should also add and grant operator privileges to the accounts used to manage the RTR network.

7.1 RTR Monitor Pictures

RTR supplies many monitor pictures to help you troubleshoot your application. To display a monitor picture, use the following command at the RTR prompt:

```
RTR> MONITOR picture-name
```

The following table provides suggested monitor pictures to display when you encounter problems:

For this type of failure:	Use these monitor pictures:
Most common problems	SYSTEM
Connection failures	ACCFAIL, CONNECTS, FRONTEND, LINK, NETSTAT, STALLS
Transaction sequence problems	CALLS
Channel problems	CALLS, CHANNEL, PARTIT
Quorum problems	QUORUM, ROLEQUOR
V2 interface API	V2CALLS
Journal problems	JCALLS, JOURNAL
API problems	APP2ACP, ACP2APP, REJECTS, REJHIST, ROUTERS
XA interface problems	XA

Troubleshooting RTR Applications

7.1 RTR Monitor Pictures

For this type of failure:	Use these monitor pictures:
Application Problems	APP2ACP, ACP2APP, CALLS, CHANNEL, PARTIT, REJECTS, REJHIST, ROUTERS

See Chapter 8 for descriptions and examples of the monitor pictures, and Chapter 9 for the full syntax of the MONITOR command.

7.2 Troubleshooting a Looping RTRACP Process

When the RTRACP process goes into a loop, System Dump Analyzer (SDA) utility can be used to know the details about this process.

SDA is a utility that allows you to interpret the contents of this file, examine the status of each processor at the time of the system failure, and investigate the probable causes of the failure.

The following table provides details about some of the commonly used SDA commands:

Commands	Description
SHOW PROCESS/IMAGES	Displays the address of the image control block, the start and end addresses of the image, the activation code, the protected and shareable flags, the image name, and the major and minor IDs of the image. The /IMAGES qualifier also displays the base, end, image offset, and section type for installed resident images in use by this process.
SHOW STACK	Displays the location and contents of the process stacks of the SDA current process and the system stack.
SHOW CALL_FRAME	Displays the locations and contents of the longwords representing a procedure call frame.
SHOW PROCESS/PHD	Lists the information included in the Process Header (PHD).
EXAMINE	Displays either the contents of a location or range of locations in physical memory, or the contents of a register. Use location parameters to display specific locations or use qualifiers to display entire process and system regions of memory. Example: exam/inst @pc 20;40

Troubleshooting RTR Applications

7.2 Troubleshooting a Looping RTRACP Process

Commands	Description
EVALUATE	Computes and displays the value of the specified expression in both hexadecimal and decimal. Alternative evaluations of the expression are available with the use of the qualifiers defined for this command. Example: eval (Return PC address) + 4* Offset

For more information on the SDA utility, see the *OpenVMS Alpha System Dump Analyzer Utility Manual*.

7.3 Enabling RTR Logging

Many problems can be better analyzed when RTR logging has been enabled.

RTR logging output can be directed to a file, for example, on RTR startup.

```
$ RTR SET LOG /FILE=logfile.dat
```

You should monitor the size of the log file; archive and purge as necessary.

7.4 Starting a Facility

When a facility is started or restarted and servers are declared, RTR recovery features require that it searches journal files of backend nodes in the facility. This allows recovery of any incomplete transactions that were in-flight when the facility last existed. However, if some of the facility's recovery information exists on a backend that is not available at startup, RTR waits for access to the journal on that backend and thus appears to "hang".

This situation can be detected by using MONITOR RECOVERY; backend nodes will be waiting for access to recovery journals. If this is the case, you may follow one of these procedures to continue the startup:

- Delete the facility and recreate it without the unavailable backend.
- Begin the startup by creating a smaller facility and using the EXTEND FACILITY and TRIM FACILITY commands.
- Force a partition to abandon recovery with a SET PARTITION command.

7.5 Analyzing RTR Application Performance

This section provides guidance for System Managers who are analyzing an RTR application that is not functioning correctly.

If an application using RTR hangs, use the following checklist to analyze the situation.

1. Is there a system-level problem on the node concerned, such as a full disk?
2. Has RTR been started? Is RTR running correctly?

```
$ RTR SHOW RTR
```

```
RTR running on node MYNODE in SYSTEM mode
```

3. Are the application programs running? RTR lists the processes using RTR with the following command:

```
$ RTR SHOW PROCESS
```

The user application processes should be in this list.

4. Has the application stopped?

Use `MONITOR SYSTEM` to check for problems. If it indicates a problem with a subsystem, you can get additional information by monitoring that subsystem.

Network partitioning can also be a problem; this can happen if half or fewer of the configured backends and routers are reachable. To recognize network partitioning, use the `MONITOR QUORUM` picture. If the number of retries keep increasing without a corresponding increase in the reason counters (`CNF/RCH/QRT`), you have a partitioned network.

To check the individual links, use the `MONITOR CONNECTS` picture. This picture displays the link protocol for connected links, and the reason for a failed connection on any links.

5. Are the application programs running correctly? Use `MONITOR CALLS` to examine the state of the participating application processes.
 - Does the number of `rtr_open_channel` calls match the number of `rtr_mt_opened` messages? If they do not match, use the `MONITOR CONNECTS` picture to check individual links.
 - Use `MONITOR CONNECTS` to make sure the connection to the router is OK.
 - Look in the RTR log file for error messages concerning any unconnected node.

Troubleshooting RTR Applications

7.5 Analyzing RTR Application Performance

- Look at any unconnected nodes found, and determine:
 - Is RTR running?
 - Has the RTR command CREATE FACILITY been issued?
 - Are there DECnet problems, e.g., executor maximum links too low? Are the router nodes reachable?
- 6. Is a server waiting for an `rtr_mt_accepted` or `rtr_mt_rejected` message (in other words, has it voted, but not yet received confirmation of the outcome of the transaction)? This is most likely a problem with the application logic. Also check the database for a possible deadlock situation.
- 7. Is a client channel declaration not completing? Client channels need to have connectivity via a router node to at least one server channel before they get an `mt_opened` message. If the server is up and running, use `MONITOR QUORUM` and `MONITOR CONNECTS` to check connectivity.
- 8. Has a client channel called `rtr_receive_message` waiting for an `rtr_mt_accepted` or `rtr_reply_to_client` message and not received it within a reasonable time period? Check the application logic and the database for a deadlock.
- 9. Has a client channel called `rtr_receive_message` expecting an `rtr_mt_accepted` or `rtr_mt_rejected` message that is not forthcoming? If yes, RTR is awaiting the necessary resources for message transmission to the backend servers. Reasons could be:
 - Congestion of a network link, frontend to router or router to backend
 - Server application not correctly dequeuing messages
 - System-level problem on router or backend node
- 10. Use `MONITOR TPS` to check the transaction processing rate of each process on a system. A system's capacity is generally expressed as the throughput of the servers. If the rates are low or sporadic, contention may be the cause. For systems with throughput less than 10 tps, the `MONITOR TPSLO` display provides greater granularity in the associated bar graph.

Adding server instances can often decrease application throughput if transactions all access common data elements. Partitioning data so that server instances do not interfere with each other is one way to resolve database contention.
- 11. Use the command `SHOW PARTITION/FULL` to display the backlog of transactions on a server pool (partition). If the number of free servers is continually zero, the arrival rate of transactions is greater than the processing capacity of the existing server pool.

Troubleshooting RTR Applications

7.5 Analyzing RTR Application Performance

The MONITOR QUEUES picture also shows monitor backlogs. This display shows queuing by partition. If the service time and arrival rate of transactions are large, there are not enough servers to process the load. The remedy is to start additional server instances or decrease the processing time of each transaction. Also, many transactions or messages queued can be caused by contention which is limiting the efficiency of servers.

12. Check the state of links with:

```
$ RTR SHOW FACILITY /LINK
```

13. Check if there are sufficient concurrent application server channels to handle the transaction load; messages may have to be queued for long periods before being processed.

Use MONITOR QUEUES to check the number of outstanding messages for each partition.

14. Check for congestion by examining the network links with the longest delays by using MONITOR TRAFFIC.

Use the command MONITOR STALLS to determine if the network needs tuning.

If there is no congestion, use MONITOR FLOW to discover if a link has credits for data traffic, or if the application requires more bandwidth than is available.

15. If the RTRACP dies when adding a facility (which has a backend role on the node), suspect journal file difficulties. Ensure that the journal file is not corrupted, or incompatible with the running RTR version. In the event of journal file corruption, please contact your HP support office.

7.6 Server Crashes

Analyze the reasons why the server crashed before you restart the server. Failures that cascade could present a problem, but note that doing a restart will prevent failover.

7.7 Link-Connect Failures

The following table explains the meaning of link-connect failure codes:

Code	Text	Implications
NOTRECOGNISED	Node not recognized	Remote node that received the connection request does not have the local node in its RTR configuration.
REFUSED	Connection refused	Indicates one of the following conditions on the remote system: either RTR is not running, or a requested network protocol is not installed.
FACNOTDEC	Facility not declared	The requested facility is not configured on the remote node.
NODENOTCFG	Node not configured	The remote node has the local node in its configuration, though not as part of the requested facility.
ROLESMismatch	Roles mismatch	The remote node has the local node configured in the requested facility, but in a role other than the one requested.

Any of the above errors can occur as the result of the connection request arriving at the wrong node for any of the following reasons:

- You may have mistyped a name on either (or both) the local and remote nodes.
- DNS at either the local or remote nodes (or both) may be giving incorrect address information for the names used.
- The nodes are not in the same RTR group.
- The nodes do not support a common network protocol.
- There is a possible wildcarding error (on routers) in the facility definition.
- Wildcarding or use of the “tunnel.” prefix may be necessary due to a firewall.

7.8 Rejected Transactions

The following table explains the meaning of rejected transaction codes:

Code	Text	Implications
NODSTFND	No destination found	Primary and all alternate servers for a partition cannot be reached by the client application. This situation can be caused by network problems or services which have not been started or have crashed.
JNLFULL	Journal full	May occur when the RTR journal is full. Note that RTR reserves a percentage of the journal to ensure that in-progress transactions can be completed. The JNLFULL error is most likely to be seen with shadow servers running in remember mode, but can also be caused by many transactions being queued to an unresponsive server.
DLKTXRES	Deadlock detected transaction rescheduled	May occur during the commit cycle for multi-participant transactions or in extreme failover situations when the order of transactions must be corrected. This reject reason indicates that two transactions were interfering with each other. RTR rejects one branch of the offending transactions to clear the deadlock. Since this transaction branch is subsequently rescheduled by RTR, this reject can be considered informational.
TIMEOUT	Time out	Occurs if the <code>rtr send to server</code> timeout provided by the client application expires. This reject indicates poor responsiveness by the service.

7.9 Preparing to Submit a Problem Report

To provide sufficient information to HP Support when submitting a problem report for RTR, you can use the following procedures:

- Create a snapshot
- Generate a process dump
- Access the RTR error log

These procedures are described in the next sections.

7.9.1 Using the Snapshot Procedure

Certain difficulties can be more easily investigated if a snapshot of the problem node is made. Make a snapshot if the application hangs, causes delays, or seems to be causing other problems. Submit this snapshot with a problem report to HP Support staff based on your current support contract.

Caution on Running SNAPSHOT

Do not run snapshot on a production system if the system is running more than 49 processes or 14 partitions. The process of writing the snapshot file may occupy the RTRACP for several minutes, forcing other systems in the RTR configuration to isolate the node where snapshot is being run.

OpenVMS

On OpenVMS systems, a snapshot is made by executing a command file:

```
$ @SYS$MANAGER:RTR$SNAPSHOT.COM
```

The output is a file named `nodename_RTR_DIAGS.TMP`.

Information in this file can help to determine the possible causes of a fault (OpenVMS, DECnet, RTR, environment, database, application, and so on.) The information includes numerous RTR monitor pictures, executable image versions, process states, and so on.

UNIX/Linux

On UNIX or Linux systems, make a snapshot by entering the following command on the problem node:

```
# rtr_snapshot.sh
```

The information displayed on the screen includes many RTR monitor pictures, executable image versions, process states, and other information.

Windows

To take a snapshot on Windows, click on the Snapshot icon on the RTR menu. A DOS-style window with the title "Snapshot" appears as the snapshot is taken. The file `rtr_snapshot.log` is created in the directory where RTR runs, for example, `C:\Program Files\HP\RTR`. You can read this file with an editor such as Notepad.

Troubleshooting RTR Applications

7.9 Preparing to Submit a Problem Report

Note

If using Microsoft Windows Scripting Host, the minimum version is 5.6 for use with RTR. With an earlier version of the Scripting Host, RTR snapshot will run with reduced functionality.

To obtain the latest Scripting Host software, use the Microsoft download center at <http://msdn.microsoft.com/downloads> .

7.9.2 Generating a Process Dump

OpenVMS Systems

Certain potential difficulties can be more easily investigated by RTR Support if a dump of the RTR ACP is available. It shows diagnostics generated if unhandled exceptions occur.

The file `SY$MANAGER:RTR$STARTUP.COM` can be altered to include the definition of the logical name `RTR$DUMP_DIRECTORY` which specifies the device and directory where the dump is to be generated.

Since an RTR dump file typically uses about 5000 blocks, enough space should be available on the chosen disk. For a very large node installation, or a large number of links, the dump file may be up to 20,000 blocks.

To prepare for dump creation, make sure that:

- `SY$SHARE:IMGDMP` has been installed
- RTR has been started from an account having `CMKRNL` privilege
- The account used to start RTR has write access to the directory specified by `RTR$DUMP_DIRECTORY`

An RTR ACP dump can be created as follows:

```
$ RTR
RTR> SET MODE /UNSUPPORTED
RTR> DEBUG ACP
RTR> SET MODE /NUNSUPPORTED
^Z
$
```

Unsupported commands should be used with care.

Troubleshooting RTR Applications

7.9 Preparing to Submit a Problem Report

UNIX/Linux Systems

UNIX core files are generated with no special configuration, but their name and location may vary depending on operating system settings and how RTR is started up. For UNIX, the file `rtr_error*.log` is usually created in `/rtr`. For Linux, it is usually created in `/var/opt/rtr`.

Windows Systems

On Windows systems, a process dump file can be generated by enabling the Dr. Watson post-mortem crash analyzer. This is done by entering the MS-DOS command:

```
(%WINDIR%\drwtsn32 -i)
```

The files created are `%WINDIR%\DRWTSN32.LOG` and `%WINDIR%\USER.DMP`.

These files should be included with any problem report submitted to RTR Engineering in the event of an RTR crash, along with the RTR dump file (`RTR_<n>.DMP`) and the RTR log file. The file `rtr_error*.log` is also created. Send in `*.log` files when reporting an error, if running RTR with logging in use.

7.9.3 Accessing the RTR Error Log

To provide the RTR Error Log, run RTR with logging in use. This creates the RTR Error Log, `rtr_error*.log`. This file resides in the `RTR$DUMP_DIRECTORY`, as listed by operating system in Table 7-1.

Table 7-1 Physical Location of RTR Error Log

For this Operating System:	The RTR Error Log is in:
HP-UX	<code>/var/opt/rtr</code>
OpenVMS	<code>RTR\$DUMP_DIRECTORY:rtr_error.log</code>
Linux	<code>/var/opt/rtr/rtr_error*.log</code>
Windows	Program Files -> HP -> RTR <code>rtr_error*.log</code>

RTR Monitoring

This chapter describes the **RTR monitor** and provides examples of its use with the CLI interface. Displays with the browser interface contain the same information in a comparable format.

The RTR monitor lets you view the activities of RTR and your applications. Many different aspects of RTR's behavior can be viewed, allowing the activities and performance of RTR to be analyzed.

8.1 Introduction

The RTR monitor provides a means to continuously display the status of RTR and the applications using it.

It can be used to check the correct operation of an RTR network, showing information useful for tuning, capacity planning, and locating configuration and application errors.

The information displayed is composed of named data items which are continuously updated by RTR. These data items can be displayed in various formats and combined using simple arithmetic operators and constants.

The monitor is invoked with the `MONITOR` command. `MONITOR` displays a monitor picture that is periodically updated. See Section 9.2 for the full syntax of the `MONITOR` command.

A monitor picture contains elements that are either text (such as labels and titles) or variables derived from data items. Monitor pictures can be defined either interactively at the `RTR>` prompt or in a file called a monitor file.

You can use monitor files provided with RTR and you can create your own. See Appendix A for information about creating monitor files.

RTR Monitoring

8.2 Standard Monitor Pictures

8.2 Standard Monitor Pictures

A number of standard monitor pictures are supplied with RTR. These cover most of the usual monitoring requirements. You may define your own monitor pictures or alter the standard ones to suit your particular needs. Table 8–1 contains a list of the standard monitor pictures. To display one of these pictures, use the following command at the RTR prompt:

```
RTR> MONITOR picture-name
```

The files for standard monitor pictures are installed on your system when RTR is installed. The location of these files is platform specific. The file names are the picture name appended with `.mon`. Type the file name without `.mon` when starting the display.

See Chapter 9, RTR Commands, for more information on the MONITOR command.

Table 8–1 Standard Monitor Pictures

Picture name	Description
accfail	Shows link transport name for links on which a connection attempt was declined, with a reason for failure. The most recent entry is highlighted.
acp2app	Displays counts of messages and number of bytes from RTRACP to the application, as viewed from a specific node.
active	Displays a list of RTR processes, and for each process the number of transactions they have started, the number of transactions they have completed and the number of transactions that are still active.
alarm	Displays a list of RTR alarms.
app2acp	Displays counts of messages and number of bytes from the application to RTRACP, as viewed from a specific node.
appdelay	Displays counts of flow-control induced traffic stalls by application process.
broadcast	Displays information about RTR user events by process, including number of user events enqueued, received, and discarded.

(continued on next page)

Table 8–1 (Cont.) Standard Monitor Pictures

Picture name	Description
calls	Displays the total number of RTR API calls and their success or failure for the processes on all the nodes being monitored. All RTR messages are also shown by message type. (Pending messages are those that an application has not received yet). Use the /IDENTIFICATION=process-id qualifier to display the values for one specific process, otherwise the total values for all processes are displayed.
channel	Displays the roles of the channels declared by an application. This can be useful as a debugging tool in the early stages of application development.
compress	Displays compression configuration and operation information.
connects	Displays connection status summary, including the number of links up and down, and a list of links with state (up or down), architecture, network transport, and fail-reason, if any.
ctccalls	Displays the history of calls for a specific client transaction controller.
downstream	Displays counts of downstream flow-control induced traffic stalls.
event	Displays event routing data by facility, with totals. Information includes events in transit and destination information showing number of events delivered to applications, processed, incoming, forwarded, and discarded.
explorer	Displays RTR Explorer information.
fastrecovery	Displays the number of transactions recovered during optimized shadow recovery.
flow	Displays the flow control counters.
flostalls	Displays counts of flow-control induced traffic stalls.
frontend	Displays frontend status and counts by node and facility, including frontend state, current router, reject status, retry count, and quorum rejects.
group	Shows server and transaction concurrency by partition.
ipc	Shows counts of interprocess communication (IPC) activity in the RTR ACP and active RTR applications.
ipcrate	Displays rate information on IPC messages, byte counts, and I/O primitive usage.
jcalls	Displays counts of successful (success), failed (fail) and total journal calls for local and remote journals.

(continued on next page)

RTR Monitoring

8.2 Standard Monitor Pictures

Table 8–1 (Cont.) Standard Monitor Pictures

Picture name	Description
journal	Displays detail for local and standby journal usage. Includes counts of the number of blocks in use, percent of journal used, number of blocks, top blocks, blocks available, transaction (tx) entries, transaction records, memory bytes, disk reads, blocks read, disk writes, blocks written, entries total, records total, records read, record bytes read, non-transaction entries and open journals. Also provides bar graphs that show usage of journal blocks as a percent of the total.
juse	Displays bar graphs of Maximum, Allocated, In Use and Peak usage for local and standby journals.
link	Displays a number of per-link data items. Use the /LINK=link-name qualifier to display the values for one specific link, otherwise the total values for all links are displayed.
lrc	Displays link checksum configuration and operation status.
management	Displays number of recoveries, transactions processed, partition activations and links established.
netbytes	Displays a list of the links to other nodes. For each link, the total number of bytes received and sent on that link and the number of bytes received and sent per second are displayed.
netstat	Displays for each link the connection status in detail, with the link state (up or down), and architecture type of remote node (such as VAX, I386, Alpha, and so on).
ortr	Displays a list of server/client transaction controllers.
partit	Displays the status of server partitions. Shows the partition identifiers, key ranges and key segments, and the status of the servers (active, recovering and so on).
queues	Shows transaction queues on a partition basis.
quorum	Tracks (by facility) the configuration, reachability, and quorum status of one or more nodes.
recovery	Displays the status of server recovery procedures, such as waiting for quorum, catching up transactions, and so on.
rejects	Displays the last rtr_mt_rejected message received by each running process.
rejhist	Displays the last 10 rtr_mt_rejected messages received by the selected process.
response	Displays the elapsed time that a transaction has been active on the opened channels of a process.

(continued on next page)

Table 8–1 (Cont.) Standard Monitor Pictures

Picture name	Description
rolequor	Displays a detailed picture of the various data items in the QUORUM picture, separated by roles. If a quorum problem is encountered, this picture may be useful for problem diagnosis.
routers	Displays information on a router node. It gives an indication of the utilization of the router in terms of transactions and broadcasts routed through this node. Useful to monitor performance or locate problems.
routing	Displays statistics of transaction and broadcast traffic by facility.
rsobe	Displays the most recent call's history for the RSC subsystem on a backend node.
stalls	Displays in real time any network links currently stalling in their outbound traffic, and provides a history of the stalls that the various links encountered during their lifetime.
stccalls	Displays a history of calls for a specified server transaction controller.
summary	Displays channel, transaction, and system environmental information including number of transactions and broadcasts processed to date.
system	Displays the state of critical resources within the RTR environment. If a resource has exceeded a predefined threshold, a warning indicator is displayed.
tps	Displays the rate of transaction commits performed by each process using RTR.
tpslo	Displays low end of the rate of transaction commits performed by each process using RTR.
traffic	Displays a list of the links to other nodes. Shown for each link are: byte rate, packet rate, message rate and congestion, in both directions. Average packets per second is also shown.
trans	Displays transactions for a frontend, router and backend.
upstream	Displays upstream flow-control-induced traffic stalls.
v2calls	Shows RTR Version 2 verb usage through the interoperability subsystem. The screen layout is identical to the RTR Version 2 Monitor Call's picture.
wq_facility	Displays the state of the ACP channel wait queues by facility.
wq_process	Displays the state of the ACP channel wait queues by process.
xa	Displays XA counter information including success and failure as well as call and read-only counters.

The following sections describe the more commonly used standard monitor pictures in detail.

RTR Monitoring

8.2 Standard Monitor Pictures

8.2.1 Monitor Accfail

Displays link acceptance failures. When configuring RTR, nodes can sometimes fail to connect. Although the cause of the error can be viewed on the initiator side with the MONITOR NETSTAT picture, it can be difficult to pinpoint the problem when looking at the other end of the link. Use the MONITOR ACCFAIL picture to display the reason for the local node's refusal to accept connections.

Example 8-1 Monitor Accfail

```
=====
                        U n a c c e p t a b l e   L i n k s
Most recent links on which a connection attempt was declined
Node: NODE11                      Wed Jan  7 1998 10:51:00
-----
Link Transport Name(s)             Reason for failure
-----
nodef                               node is not configured for the facility
marke.zko.dec.com                  node not recognized
reall                               facility name not matched
MARKE DEC::.ZKO.MARKE              node not recognized
nodef                               node is not configured for the facility
marke.zko.dec.com                  node not recognized
reall                               facility name not matched
nodez                               node role definitions do not match for
reall                               facility name not matched
MARKE DEC::.ZKO.MARKE              node not recognized
-----
List entries are reused in a cyclical fashion; the most
recent entry is highlighted.
=====
```

Errors that can be displayed by ACCFAIL include:

- RTR_STS_NOTRECOGNISED - "node not recognized"

The local node has received a connection request over a link that is not configured in any facility on the local machine. If you expected the connection to succeed as the result of having a template link defined, check carefully the names displayed in the monitor picture. These are the names obtained from the network transport over which the link connection attempt was received, and it is with these that a match with a template (wildcard specification) link must succeed. Remember that the name match is performed in a case-sensitive manner. Names corresponding to TCP links may or may not contain your domain name, depending on how the

RTR Monitoring

8.2 Standard Monitor Pictures

name is entered in either your local hosts file or name server. DECnet-Plus systems may yield both a pseudonym and a link name; both are checked for a match with a template.

- RTR_STS_FACNOTDEC - "facility name not matched"
The connecting link is configured, but the facility that it requests does not exist on the local node.
- RTR_STS_NODENOTCNFG - "node is not configured for the facility"
The connecting link is configured on the local node, but not as part of the requested facility.
- RTR_STS_ROLESMISMATCH - "node role definitions do not match for this facility"
The connecting link is configured in the requested facility, but with a different role configuration on the local node.
- RTR_STS_TRNOQUO - "router has no quorum in facility %s"
The router is unable to accept frontend connections since it is not quorate. This condition will clear up automatically as soon as the router gains connections to sufficient backends.

8.2.2 Monitor Acp2app

Displays counts of messages and number of bytes from RTRACP to the application, as viewed from a specific node. Includes opened, closed, msg1, msg1_uncertain, msgn, reply (reply to client), rettosend (return to sender), accepted, prepared, rejected, user_event, rtr_event, prepare, request_info, and set_info messages as appropriate. For receive_message and user_wakeup, displays calls, active, fail, and timeout counts. Refer to the *HP Reliable Transaction Router C Application Programmer's Reference Manual* for an explanation of the message types.

The default is to display information on all PIDs, process names, and images. To display information on one process only, use the qualifier /IDENTIFICATION=process-id.

RTR Monitoring

8.2 Standard Monitor Pictures

Example 8-2 Monitor Acp2app

```

RTR ACP to Application Messages, Node: NodeA PID: 1568 Process name: -ALL-
Image: -ALL- 14:15:46 Tue Dec 04 2001
Message Type Client Server Other Pend
# Bytes # Bytes # Bytes #
opened 4 760 3 38 0 0 8
closed 0 0 1 136 43492 295745 1
msg1 0 0 0 170 0 0 2
msg1_uncertain 0 0 0 0 0 0 0
msgn 0 0 0 253 0 0 3
reply 0 0 0 0 0 0 0
rettosend 0 0 0 0 0 0 0
prepared 0 0 0 0 0 0 0
accepted 0 0 0 0 0 0 0
rejected 0 0 0 68 0 0 1
user_event 0 0 0 0 0 0 0
rtr_event 0 0 0 0 0 0 0
prepare 0 0 0 0 0 0 0
Other
request_info 43347 5211764 0
set_info 0 0 0
Calls Active Fail Timeout
receive message 88607 1 1759 1759
user_wakeup 0 0

```

8.2.3 Monitor Active

Displays a list of RTR processes, and for each process the number of transactions they have started, the number of transactions they have completed, and the number of transactions still active.

OpenVMS systems show actual process names; on Windows and UNIX systems RTR produces a process name by combining user name and image name.

Example 8-3 Monitor Active

```

ACTIVE TRANSACTIONS BY PROCESS Fri Mar 12 1999 19:32:41
Display totals: Starts Complete Active
                    5         5         0
Node ID Process name Image name
NodeA 11141 SMITH_1 DISK01:[SMITH]RTR 5 5 0

```

8.2.4 Monitor Alarm

Displays counts of RTR alarms. Shows the kilobytes sent, kilobytes received, number of alarms sent, and number of alarms received for internal alarm detection on the target node. Each node on the RTR network detects its own alarms, and then sends the alarms to their associated router. For backends, that means all routers. For routers, it means itself. For frontends, it means the router to which it is connected.

Thus each node may send alarms, and routers may receive alarms.

Example 8–4 Monitor Alarm

```
Alarm Detection Traffic at 11:28:46 Wed May 28 2003
node: rage

Facility          KBytesSent    KBytesRcvd    AlarmsSent    AlarmsRcvd
Facility1         5.57          5.57          42             42
Facility2         3.29          3.29          10             10
Facility3         5.64          5.64          43             43
Facility4         3.36          3.36          11             11
```

8.2.5 Monitor App2acp

Displays counts of messages and number of bytes from the application to RTRACP, as viewed from a specific node. Includes `open_channel`, `close_channel`, `prepare_tx` (prepare transaction), `accept_tx` (accept transaction), `reject_tx` (reject transaction), `broadcast_event`, `start_tx`, `send_to_server`, `reply_to_client`, `request_info`, and `set_info`. Refer to the *HP Reliable Transaction Router C Application Programmer's Reference Manual* for an explanation of the message types.

The default is to display counts for all PIDs and processes, for client, server, and other roles.

RTR Monitoring

8.2 Standard Monitor Pictures

Example 8–5 Monitor App2acp

```
RTR Application to ACP Messages, Node: NodeA  PID: 1568 Process name: -ALL-
Image: -ALL-                               14:21:19 Tue Dec 04 2001
RTR Message Type      Client          Server          Other
#      Bytes      #      Bytes      #      Bytes
open_channel          11      8228      7      5376      0      0
close_channel         5       120       3       72        0      0
prepare_tx            0        0         0        0         0      0
accept_tx             0        0         0        0         0      0
reject_tx             0        0         0        0         0      0
broadcast_event       1        81        0        0         0      0
start_tx              2        0         0        0         0      0
send_to_server        5       548       0        0         0      0
reply_to_client       0        0         0        0         0      0
request_info          0        0         0        0         43768 16015270
set_info              0        0         0        0         0      0
```

8.2.6 Monitor Appdelay

Displays counts of flow-control-induced traffic stalls by an application process.

Example 8–6 Monitor Appdelay

```
FLOW CONTROL STALLS BY PROCESS Tue Dec 04 2001 15:38:37, NODE: rtrdoc
PID      Process Name      Txn traffic stalls      Bdcst traffic stalls      KBytes
reqs times secs max      reqs times secs max      sent
Total   *                  1  0  0  0          1  0  0  0          45528
1568    user rtr           1  0  0  0          1  0  0  0          45528
```

8.2.7 Monitor Broadcast

Displays information about the RTR user events process. Fields displayed include number of user events enqueued for the application, number of user events received by the application, and number of user events discarded by RTR.

RTR Monitoring 8.2 Standard Monitor Pictures

Example 8-7 Monitor Broadcast

```
BROADCAST RECEPTION BY PROCESS 15:20:27 6-APR-1999
```

Node	ID	Process name	Received	Queued	Lost	Delivery Rate
Total			2750	5	17	850.0
NODEA	20400249	SMITH RTR	0	0	0	
NODEA	2040024D	JONES RTR	2750	5	17	850.0
NODEA	2040024B	BROWN RTR	0	0	0	
NODEA	2040024C	ALLEN RTR	0	0	0	

8.2.8 Monitor Calls

Displays the total number of RTR API calls and their outcome for the processes on all the nodes being monitored. Use the /IDENTIFICATION=process-id qualifier to display the values for one specific process, otherwise the total values for all processes are displayed.

RTR Monitoring

8.2 Standard Monitor Pictures

Example 8-8 Monitor Calls

```

RTR API calls, Node: nodea          , PID: 2162      , Process name: -ALL-
Image: -ALL-                        16:38:05 Tue Dec 04 2001
CALLS
open_channel      Client  server  fail  MESSAGES      client  server  pend
open_channel      11     7       18   mt_opened      4       3       4
close_channel     5      3       0    mt_closed      0       1       0
start_tx          2      -       4    mt_msgl        -       0       2
send_to_server    5      -       2    mt_msgl_uncertain -       0       0
                  mt_msgn        -       0       3
reply_to_client   -      0       4    mt_reply       0       0       0
                  mt_rettosend   0       -       0
prepare tx        0      -       0    mt_prepared    0       -       0
accept_tx         0      0       0    mt_accepted    0       0       0
reject_tx         0      0       0    mt_rejected    0       0       1
broadcast event   0      0       0    mt_user_event  0       0       0
set_user_handle  0      0       0    mt_rtr_event   0       0       0
get_tid           0      0       0    mt_prepare     -       0       0
other
request info      3      -       1    mt_request_info 2       -       0
set_info          0      -       0    mt_set_info    0       -       0
error_text        2      -       -    mt_closed      2
set_wakeup        0
calls active fail timeout
receive message  9      1       2     2
user wakeup      0      0

```

8.2.9 Monitor Channel

Displays the channels opened by the CALL RTR_OPEN_CHANNEL command.

OpenVMS systems show the actual process names; on Windows and UNIX systems RTR produces a process name by combining user name and image name.

Example 8-9 Monitor Channel

```

RTR CHANNELS BY TYPE PER PROCESS 16:41:13 Tue Dec 04 2001
Node ID Process name Image name Client Server Router Backend
Nodea 2162 SMITH_1 DISK01:[SMI... 6 3 0 0

```

8.2.10 Monitor Compress

Displays compression configuration and operation information. Information displayed includes the following:

- Compression settings and results for replies from server to client channels.

RTR Monitoring 8.2 Standard Monitor Pictures

- Compression settings and results for server and client generated broadcast events.
- Name of computer sending the sample, and the application process ID and name.
- Compression threshold setting in bytes (environment variable RTR_REPLY_COMPRESS_THRESHOLD). Only larger replies are compressed. A value of 0 indicates that compression is not enabled.
- The reply compression level in effect for the process (environment variable RTR_REPLY_COMPRESS_LEVEL). A value of -1 indicates the default compression level is selected.
- Average compression effectiveness for server replies, ranging from 100 (perfect) to 0 (completely ineffective) or even less than 0. This column is only displayed if reply compression is enabled.
- Compression threshold setting in bytes (environment variable RTR_EVENT_COMPRESS_THRESHOLD). Only larger events are compressed. A value of 0 indicates that compression is not enabled.
- The event compression level in effect for the process (environment variable RTR_EVENT_COMPRESS_LEVEL). A value of -1 indicates the default compression level is selected.
- Average compression effectiveness for client generated events, ranging from 100 (perfect) to 0 (completely ineffective) or even less than 0. This column is only displayed if event compression is enabled.
- Average compression effectiveness for server generated events, ranging from 100 (perfect) to 0 (completely ineffective) or even less than 0. This column is only displayed if event compression is enabled.

RTR Monitoring

8.2 Standard Monitor Pictures

Example 8-10 Monitor Compress

COMPRESSION OVERVIEW BY PROCESS 17:38:13 Wed Oct 15 2003 on -ALL-

```

                                +-Replies-----+ +-Events-----+
                                ClientServer
Node, Process ID & name  Threshold Level Ratio Threshold Level Ratio Ratio
nodeaa 10712 10712      0      0      0      0
rtrm08 1940  usertest v3t_sr  1     -1 100.0      0     -1
rtrm08 2108  usertest v3t_sr  1     -1 100.0      0     -1
rtrm08 2072  usertest v3t_sr  1     -1 100.0      0     -1
rtrm08 2020  usertest v3t_sr 999   -1 100.0      0     -1
rtrm08 1856  usertest v3t_sr  0     -1
rtrm08 2120  usertest v3t_sr  0      9
rtrm08 2112  usertest v3t_sr  0      9      555   -1 100.0 100.0
rtrm08 156   usertest v3t_sr  0      9      555   3 100.0 100.0
rtrm08 2168  usertest rtr.ex 777   9  91.0      666   3  88.4  88.1

```

8.2.11 Monitor Connects

Displays the link protocol for connected links, and the fail reason as a text message for any links on which a connection has failed. Unconnected links where connection has been attempted are highlighted. Link state and architecture of the remote node are also displayed. Summarizes link status and is less detailed than the MONITOR NETSTAT display.

Example 8-11 Monitor Connects

```

          C o n n e c t i o n   S t a t u s   S u m m a r y
Node: nodea                               Tue Feb 16 1999 13:02:18
Executive summary-----
      Number of links up:      3
      Number of links up (%): 100.0
      Required links up:     Yes
-----
-Detail-
Node -> Link  State  Arch T'port Fail-reason
-----:-----:-----:-----:-----
nodea->nodea   up  alpha  -
nodea->nodeb   up  alpha  TCP
nodea->nodec   up  i386   TCP

```

8.2.12 Monitor Ctccalls

Displays the history of calls for a specific client transaction controller. Valid only when the application is using the C++ API.

Example 8–12 Monitor Ctccalls

```
ORTR Call history monitor screen on node:walkin          PID : -ALL-
Image: -ALL-                                           at 16:48:32 Mon Jul 16 2001
Calls          Channel #                State      Msg/Event   Ch.Used   Status
```

8.2.13 Monitor Downstream

Displays counts of flow-control induced traffic stalls downstream from the backend, between the backend and the router, and between the router and the frontend. Downstream traffic runs away from the backend.

Example 8–13 Monitor Downstream

```
FLOW CONTROL STALLS DOWNSTREAM BY NODE & FACILITY Mon Jul 16 2001 15:40:21, NODE
Node & Facility          Txn traffic      Bdcst traffic
                        be->tr    tr->fe    be->tr
rtrdoc  Test            reqs stall reqs stall reqs stall
```

8.2.14 Monitor Event

Displays event routing data by facility, with totals. Destination columns count the number of events received by the local node and facility delivered to application channels, based on their subscriptions. Transit columns count the number of events that are in transit from the router to remote nodes in the destination facility.

The count columns contain the following:

- Destination In: Count of events for facility and node.
- Destination Out: Count of events delivered to applications. This may be less than the Destination In count if all applications do not subscribe to all events.
- Destination Lost: Count of events discarded by RTR because the application was too busy to receive them (events discarded to prevent channel queue overflow).
- Transit In: Count of incoming events handled by the router. This count is zero if a node is not a router.

RTR Monitoring

8.2 Standard Monitor Pictures

- **Transit Out:** Count of forwarded events. Includes all events forwarded by the router and any events originating on the local node, including RTR events such as those generated by the router in response to link events.
- **Transit Lost:** Count of transit events discarded by RTR because the RTR router was too busy to receive them (events discarded to prevent link transmission queue overflow).

Example 8–14 Monitor Event

```
EVENT ROUTING STATISTICS BY FACILITY  Fri Sep 08 2000 15:21:47
```

Node & Facility	Destination			Transit		
	In	Out	Lost	In	Out	Lost
Total	180	175	5	180	180	0
NODEA FACCMS	25	25	0	25	25	0
NODEA TESTFAC	155	150	5	155	155	0

8.2.15 Monitor Explorer

Displays counts of RTR Explorer events. Shows the kilobytes sent, kilobytes received, number of alarms sent, and number of alarms received for backend data gathering on the target node. When RTR Explorer information is requested on a backend, either directly by using the GCS information class with API call `rtr_request_info()`, or indirectly by viewing the RTR Explorer via a web browser, the backend must gather all configuration and status information from all routers.

Thus the routers may send this information, and the backends may gather this information.

Example 8–15 Monitor Explorer

```
RTR Explorer Traffic at 11:34:53 Wed May 28 2003
node: rage
```

Facility	KBytesSent	KBytesRcvd	AlarmsSent	AlarmsRcvd
Facility1	4.47	4.47	20	20
Facility2	2.71	2.71	5	5
Facility3	4.54	4.54	21	21
Facility4	2.78	2.78	6	6

8.2.16 Monitor FastRecovery

Displays information on the number of transactions received in several recovery stages.

Example 8-16 Monitor FastRecovery

RECOVERY INFORMATION at Tue Dec 04 2001 09:57:51, on NodeA

Partition	Server State	Last Rcvy Backend	Currnt Txns Rcvd	Restart Txns Rcvd	CTR Txns Rcvd	Total CTR Rcvd	Shadow-Recovery Classic Rcvd	Copied Rcvd
RTR\$DEFAULT	active	NODEA	1	0	0	0	0	0

8.2.17 Monitor Flostalls

Displays counts of flow-control-induced traffic stalls.

Example 8-17 Monitor Flostalls

FLOW CONTROL INDUCED STALLS BY FACILITY Mon Jul 16 2001 15:41:03, NODE: rtrdoc

Node & Facility	Request traffic		Response traffic	
	fe->tr reqs stall	tr->be reqs stall	be->tr reqs stall	tr->fe reqs stall
rtrdoc Test				

8.2.18 Monitor Flow

Displays flow control internals.

Example 8-18 Monitor Flow

FLOW CONTROL COUNTERS Tue Sep 19 2000 14:08:06, NODE: -ALL- , FAC: -ALL-

Role	Credit Available	Data Rate Bytes/sec	Requests			Grants	
			Waits	Sent	Pending	Sent	Pending
FE=>TR	15000	2065	307	966	0	966	0
TR=>BE	15000	2065	70	998	0	998	0
BE=>TR	0	0	0	0	0	0	0
TR=>FE	15000	0	0	2		2	0

(continued on next page)

RTR Monitoring

8.2 Standard Monitor Pictures

Example 8–18 (Cont.) Monitor Flow

Link	Data Rate	Waits	Pending	Reqs Sent	Cache in use
NODEA =>NODEA	0	0	0	1	NODEA 0
NODEA =>NODEB	0	0	0	0	NODEB 51456
NODEB =>NODEB	2065	307	0	968	
NODEB =>NODEA	2065	70	0	999	

8.2.19 Monitor Frontend

Displays frontend status and counts by node and facility, including frontend state, current router, reject status, retry count, and quorum rejects.

Example 8–19 Monitor Frontend

```
FRONTEND STATUS BY NODE AND FACILITY Tue Dec 04 2001 10:46:24, NODE:NODEA
```

Node	Facility	FE State	Router	Reject Status	Retry Count	Quorum Rejects
NODEA	RTR\$DEFAULT FACILITY	cnctd to	smith		2	0
NODEA	funds transfer	cnctd to	smith		2	0
NODEA	payroll	waiting		no_qrum	395	0

8.2.20 Monitor Group

Shows server and transaction concurrency by partition.

Example 8–20 Monitor Group

```
Concurrency Measures Tue Dec 04 2001 10:04:26, NODE: NODEA
```

Partition	state	-- averages --									
		txn cnt	-server- cnt	act	vreq	vote	ack /csn	srv act	txn /sec	txn /csn	
RTR\$DEFAULT	active	2	3	1	0	0	0	0	1.0	0.0	0.0

Table 8–2 MONITOR GROUP Fields

Field	Meaning
Partition	Partition
state	Partition state.

(continued on next page)

Table 8–2 (Cont.) MONITOR GROUP Fields

Field	Meaning
txn cnt	Number of transactions executed for this partition.
srv cnt	Number of servers active for this partition.
srv act	Number of servers currently busy processing transactions for this sample.
The following fields track the progress of a transaction through the states: vote requested, voted, acknowledged.	
vreq	Number of transactions waiting for the server to vote.
vote	Number of transactions that have been voted on by the server but not committed by RTR.
ack	Number of transactions that have been committed but have not been acknowledged by the server. Acknowledgment occurs on a subsequent <code>rtr_receive_message()</code> call by the server processing this transaction to get a message for a new transaction.
/csn	Number of transactions which have been grouped under the same “commit sequence number” (CSN). This grouping determines the ordering of transactions submitted to a secondary shadow server.
txn/sec	The average rate of transaction starts per second for this partition.
txn/csn	Average number of transactions which have been grouped under the same commit sequence number (CSN) since this partition became active. This average is computed as the quotient of the <code>txn cnt</code> column and the total number of CSNs.

8.2.21 Monitor lpc

Displays interprocess communication message information.

Example 8–21 Monitor lpc

```
Node: NODE11                I P C   S u m m a r y   Fri Mar  5 1999 11:18:34
+-----+
  This screen displays usage information on IPC messages, byte counts and IO
  primitives. Display units are counts, kbytes and calls respectively.
+-----+
```

(continued on next page)

RTR Monitoring

8.2 Standard Monitor Pictures

Example 8–21 (Cont.) Monitor Ipc

```
      | - - - - - O u t g o i n g / s - - - - - | - - I n c o m i n g / s - - |
Process  Messages  ...kbytes  send()  ...kbytes  Messages  recv()  ...kbytes
rtracp   110334    49744    73437   49744    73434    220299   5616
3123B84F      0         0         0         0         0         0         0
31232395   73282    5569    73280    5569    109930   293144   49685
```

8.2.22 Monitor Ipcrate

Displays information on interprocess communication message rates.

Example 8–22 Monitor Ipcrate

```
Node: NODE11          I P C   R a t e s          Fri Mar  5 1999 11:18:53

+-----+
| This screen displays rate information on IPC messages, byte counts and IO primitive usage. Display units are counts, kbytes and calls per second respectively. |
+-----+

      | - - - - - O u t g o i n g / s - - - - - | - - I n c o m i n g / s - - |
Process  Messages  ...kbytes  send()  ...kbytes  Messages  recv()  ...kbytes
rtracp   44         19         29         19         29         86         2
3123B84F      0         0         0         0         0         0         0
31232395   28         2         28         2         41        110        18
```

8.2.23 Monitor Jcalls

Displays counts of successful (success), failed (fail) and total journal calls for local and remote journals.

Example 8–23 Monitor Jcalls

```
JOURNAL CALLS ON NODE LENGTH                AT 04:43:38 Thu Feb 3 2005
```

Journal API	Local Journal			Remote Journal			Total
	Success	Fail	Total	Success	Fail	Total	
OPEN_JOURNAL	1	0	1	0	0	0	0
CLOSE_JOURNAL	0	0	0	0	0	0	0
READ_RECORD	17288	0	17288	0	0	0	0
READ_NEXT_RECORD	0	40	40	0	0	0	0
GET_USAGE	4351	0	4351	0	0	0	0
WRITE_RECORD	34598	0	34598	0	0	0	0
FLUSH_TO_DISK	17705	71	17776	0	0	0	0
DELETE_RECORD	18175	0	18175	0	0	0	0

Segment Fmts	Local Journal				Remote Journal			
	Direct	Qued	Requed	Deferd	Direct	Qued	Requed	Deferd
	0	0	0	0	0	0	0	0

	#	BLOCKS	#	BLOCKS
Extends	0	0	0	0

8.2.24 Monitor Journal

Displays information about journal usage, including total number of entries and records written, number of records read, and how many bytes were involved. Bar graphs showing current usage of journal blocks (as a percentage of the total) are also provided. The bar graphs appear under the first line of the display JNL_xxx_BLOCKS_IN_USE.

The local journal is the journal on the named node. Standby journals are journals of standby nodes that are being accessed due to restart or catch-up situations. Under normal conditions, standby journal counts are zero.

RTR Monitoring

8.2 Standard Monitor Pictures

Example 8–24 Monitor Journal

```

JOURNAL USAGE ON NODE NODEA                AT 10:36:05 Wed Jan 15 2003
LOCAL JOURNAL                                STANDBY JOURNAL(S)
JNL_LCL_BLOCKS_IN_USE          128
[      13%      ]
JNL_LCL_NR_BLOCKS              992
JNL_LCL_TOP_BLOCKS_USED        128
JNL_LCL_BLOCKS_AVAILABLE      864
JNL_LCL_TX_ENTRIES             1
JNL_LCL_TX_RECORDS             2
JNL_LCL_MEMORY_BYTES          530121
JNL_LCL_DISK_READS             31
JNL_LCL_BLOCKS_READ           992
JNL_LCL_DISK_WRITES            12
JNL_LCL_BLOCKS_WRITTEN         14
JNL_LCL_ENTRIES_TOTAL          201
JNL_LCL_RECORDS_TOTAL          398
JNL_LCL_RECORDS_READ           21
JNL_LCL_REC_BYTES_READ         8006
JNL_LCL_NONTX_ENTRIES          5
JNL_LCL_OPEN_JOURNALS          2
JNL_RMT_DISK_READS             33
JNL_RMT_BLOCKS_READ            1056
JNL_RMT_DISK_WRITES            0
JNL_RMT_BLOCKS_WRITTEN         0
JNL_RMT_RECORDS_READ           0
JNL_RMT_REC_BYTES_READ         0
JNL_RMT_OPEN_JOURNALS          0

```

8.2.25 Monitor Juse

Displays bar graphs of usage for local and remote journals.

Example 8–25 Monitor Juse

```

JOURNAL USAGE ON NODE NODEA                AT 11:18:19 Fri Sep 17 2004
LOCAL JOURNAL BLOCKS
Maximum                          992
Allocated                        992
[      100%      ]
In use                            576
[      58%      ]
Peak                              576
[      58%      ]

```

8.2.26 Monitor Link

Displays a number of per-link counters. The /LINK=link-name qualifier can be used to display the values for one specific link; otherwise the total values for all links are displayed.

Example 8–26 Monitor Link

```
LINK COUNTERS Tue Sep 19 2000 14:24:44, NODE: -ALL- , LINK: -ALL- -> -ALL-  
ncf_protocol          0          nio_writing           0  
ncf_timeout           0          nio_reading           0  
ncf_linkexit          0          nio_wrerror          0  
ncf_disconnect        0          nio_rdererror        0  
ncf_thirdparty        0          nio_rdincomp         0  
ncf_pathlost          0          nio_seqerr           0  
ncf_responses_sent    3          nio_bufovf           0  
ncf_queries_rcvd     11         nio_reads_active     3  
ncf_responses_rcvd    2          nio_writes_active    0  
ncf_queries_sent      10         nio_bytes_rcvd       44206961  
ncf_ipt_msgs_rcvd    16         nio_bytes_sent       44206996  
ncf_ipt_msgs_sent    16         nio_pckts_rcvd       412114  
ncf_link_gain         4          nio_pckts_sent       412114  
ncf_link_loss         0          nio_msgs_rcvd        189284  
ncf_aborted           0          nio_tmo_sends        161307  
ncf_rejected          1          nio_tot_stall_sec    0  
ncf_accepted          1          nio_tot_stalls       0  
ncf_confirmed         1          qrm_req_link_queue   0  
ncf_initiated         2          qrm_rsp_link_queue   0
```

8.2.27 Monitor Lrc

Displays link checksum configuration and operation status. Information displayed includes the following:

- Shows incoming message and checksum data for the given links.
- Number of links which are up.
- Number of links which are down.
- Total number of links.
- All required links are up.
- Some required links are down.
- Number of links with checksum enabled.
- Number of messages received with a bad checksum.
- Number of messages received from RTR V2 with an LRC.
- Number of messages received with a checksum appended.
- Number of messages received without a checksum.
- Total number of messages received on the link.

RTR Monitoring

8.2 Standard Monitor Pictures

- Total of all shown links.

Example 8–27 Monitor Lrc

```

LINK CHECKSUM ERRORS Wed Oct 15 2003 18:03:57 DEPTH <- -ALL-
Links up    2          Links down  1          Total links  3          Required links down
                enabled  lrcerror   lrcheader   lrctrailer   lrcundone   received
Total                1           0           0           34          12155189   50839617
DEPTH <- depth      0           0           0           0           0          38684394
DEPTH <- length     1           0           0           34          12155189   12155223
DEPTH <- sarand     0           0           0           0           0           0

```

8.2.28 Monitor Management

This screen summarizes key areas managed by RTR showing, for example, the number of times RTR saved the day. All the counters describe the management by RTR as a whole, as opposed to per facility or per partition. The counters remain for the life of the RTRACP process. Table 8–3 describes the content of the Monitor Management rows.

Table 8–3 Monitor Management Fields

Field	Meaning
Restart Recoveries	This row enumerates the total number of transactions recovered during RTR start-up, including local and standby recoveries. RTR automatically recovers in-progress transactions during a restart and during a standby takeover.
Shadow Recoveries	This row enumerates the total number of transactions recovered from a backend’s shadow partner. RTR automatically recovers all transactions sent to a shadow partner after the disconnected node becomes available.
Replay Recoveries	This row enumerates the total number of messages automatically replayed because of an application server death. Whenever an application server dies, RTR automatically replays the message(s) that were being handled by the server to another concurrent server.

(continued on next page)

Table 8–3 (Cont.) Monitor Management Fields

Field	Meaning
Three-Strikes Txns	This row enumerates the total number of transactions that were automatically aborted as a result of three server deaths for the same transaction. RTR prevents a single transaction from killing all application servers with this feature.
Transactions Processed	This row enumerates all transactions received by RTR. It reports the total number of transactions received by RTR on this node, regardless of the outcome of the transaction. RTR provides advanced transaction management.
Partition Activations	On the backend, this number enumerates how many times any partition went into an active state. An active state is one of active, primary active, secondary active, or remember. On the router, it enumerates the number of partition gains. RTR automatically manages transaction routing and failover with partitions.
Link Establishments	This row enumerates the total number of link establishments. Every time a link is connected or re-connected, it is considered a link establishment. RTR automatically manages network communication over TCP/IP or DECNET.

Example 8–28 Monitor Management

RTR Management at 15:23:09 Tue Jul 8 2003
Node: NODEA

	Backend Role	Router Role
	-----	-----
Restart Recoveries.....	543	NA
Shadow Recoveries.....	19735	NA
Replay Recoveries.....	56	NA
Three-strikes Txns.....	4	NA
Transactions Processed..	7385660	3958495
Partition Activations...	512	25
Link Establishments.....	57	5001

8.2.29 Monitor Netbytes

Displays a list of the links to other nodes. For each link, the total number of bytes received and sent on that link and the number of bytes received and sent per second are displayed. Derived from the NIO_BYTES_RCVD and NIO_BYTES_SENT counters. The Max field represents the maximum rate since the link started.

RTR Monitoring

8.2 Standard Monitor Pictures

Example 8–29 Monitor Netbytes

LINK TRAFFIC IN BYTES Fri Apr 16 1999 17:41:12, NODE: nodea

	Bytes received			Bytes sent		
	Count	Rate	Max	Count	Rate	Max
Total	59201466	6776.0	-	1002579480	113857.0	-
nodea->nodea	3072248	336.0	336.0	3072248	336.0	336.0
nodea->nodeb	42569496	4974.0	4974.0	717457678	84438.0	84438.0
nodea->nodec	13559722	1466.0	1466.0	282049554	29083.0	29083.0

8.2.30 Monitor Netstat

Displays the link status for connected links in detail and the fail code for any links on which a connection has failed. Unconnected links where connections have been lost are highlighted. Link aborts, rejects, loss, gain, restarts, state and architecture of the remote node are also displayed. Displays more detail than MONITOR CONNECTS.

Example 8–30 Monitor Netstat

```

C o n n e c t i o n   S t a t u s   D e t a i l
Node: NODEA                               Mon March 15 1999 09:50:28
  Ini Cnf Acc Abo Rej Loss Gain Ctmo Rstr AF0① TFO② State Type FailCode
Node and Link  12  0  2  12  12  1  3 2074 2073 863 864
NODEA ->nodeb   0  0  0  0  0  0  1  0  0  0  0  0 up alpha
NODEA ->nodec   6  0  0  6  6  0  0  0  0  0  0  0 down    ? 76490676
NODEA ->noded   6  0  0  6  6  0  0  0  0  0  0  0 down    ? 76490676
NODEA ->nodee 2591  0  0 863 2590  0  1 2074 2073 863 864 cinit  ? Remote node
                                                unreachable

```

- ① Address failover
- ② Transport failover

8.2.31 Monitor Ortr

Displays lists of server and client transaction controllers.

Example 8–31 Monitor Ortr

```

oRTR Transaction Controller List on node : rtrdoc
Image: -ALL-                                     at 15:42:55

Server Controllers                               Client Controller
STC000                                           CTC000
STC001                                           CTC001
STC002                                           CTC002
STC003                                           CTC003
STC004                                           CTC004

```

8.2.32 Monitor Partit

Displays partitions as partition name if a partition name has been specified using the SET PARTITION command. The number of servers and key segments are shown for each partition. The least-significant byte of the partition's low and high bound is also shown, and callout type (if any). Table 8–4 shows partition state meanings.

Example 8–32 Monitor Partit

```

PARTITION DEFINITIONS  Tue Apr 6 1999 10:40:31, NODE: NODEA

Partition name                #      #      Bounds      Callout
                               State  Svrs Segs  lo      hi      type
RTR$DEFAULT_PARTITION_16777218  active  1    1  "A"     "A"     -
RTR$DEFAULT_PARTITION_16777221  active  1    1  "B"     "B"     -
RTR$DEFAULT_PARTITION_16777217  active  1    1  0       429496  -

```

Table 8–4 Monitor Partition States

State	Meaning
wt_tr_ok	Server is waiting for routers to accept it
wt_quorum	Server is waiting for backend to be quorate
lcl_rec	Local recovery
lcl_rec_fail	Primary server waiting for access to a restart journal

(continued on next page)

RTR Monitoring

8.2 Standard Monitor Pictures

Table 8–4 (Cont.) Monitor Partition States

State	Meaning
lcl_rec_icpl	Getting next journal to recover from
lcl_rec_cpl	Processed all journals for local recovery
shd_rec	Shadow recovery
shd_rec_fail	Shadow server waiting for access to a restart journal
shd_rec_icpl	Shadow getting next journal to recover from
shd_rec_cpl	Processed all journals for shadow recovery
catchup	Secondary is catching up with primary
standby	Server is declared as standby
active	Server is active
pri_act	Server is active as primary shadow
sec_act	Server is active as secondary shadow
remember	Primary is running without shadow secondary

8.2.33 Monitor Queues

Shows transaction queues by partition. Uses counters from Transaction Manager (TM) and the Requester/Server configurator (RSC). A delay is the delay in seconds for the most recent transaction handed to a server, which on average will be the same for all servers.

Example 8–33 Monitor Queues

```
TRANSACTION QUEUES BY PARTITION Fri Sep 08 2000 12:42:53, NODE: NODEA
Partition name                Processed          Queued          #
                               Txns    Msgs  Rplys    Txn  Msg  Svrs  Dly
RTR$DEFAULT_PARTITION_16842753  5792   5794    0       2    6    3    0
```

8.2.34 Monitor Quorum

Displays for each node and facility, the state and the number of roles RTR sees as configured (CNF), reachable (RCH) and quorate (QRT). The State column shows quorum states for router (TR) and backend (BE) roles.

RTR Monitoring 8.2 Standard Monitor Pictures

Example 8–34 Monitor Quorum

```

QUORUM STATUS BY NODE AND FACILITY Tue Dec 04 2001 10:50:24, NODE: NODEA
(Counts can be inaccurate for incorrectly configured facilities)
States: bad configuration,not connected,minority,uncertain,quorate
Node & Facility                               State                               CNF RCH QRT
NODEA    RTR$DEFAULT_FACILITY                 TR:quorate,BE:quorate              2  2  2
NODEA    shadow                               TR:quorate,BE:minority(node12)     4  2  1
NODEA    payroll                              TR:bad_config(NODEB)               1  0  0

```

8.2.35 Monitor Recovery

Shows the progress of transaction recovery. Last recovery backend is the last backend accessed to recover transactions. If the server state is `lcl_rec_fail` or `shd_rec_fail`, the Last Recovery Backend is the backend that could not be accessed. Journal scans is the number of journal files searched. Transactions recovered is the number of transactions found for this partition.

Table 8–5 shows the meaning of entries in the Server State column.

Example 8–35 Monitor Recovery

```

RECOVERY INFORMATION at Tue Apr  6 1999 10:54:50, on NODEA

Partition      Server      Last      Restart-Recovery      Shadow-Recovery
               State      Recovery  Journal Txns          Journal Txns
               -----  -----  -----  -----  -----  -----
RTR_PARTITA    active     NODEA     1         0           0         0
RTR_PARTITB    active     NODEA     1         0           0         0
RTR_PARTITC    active     NODEA     1         0           0         0

```

Table 8–5 Monitor Recovery States

State	Meaning
<code>wt_tr_ok</code>	Server is waiting for routers to accept it
<code>wt_quorum</code>	Server is waiting for backend to be quorate
<code>lcl_rec</code>	Local recovery
<code>lcl_rec_fail</code>	Primary server waiting for access to a restart journal
<code>lcl_rec_icpl</code>	Getting next journal to recover from
<code>lcl_rec_cpl</code>	Processed all journals for local recovery

(continued on next page)

RTR Monitoring

8.2 Standard Monitor Pictures

Table 8–5 (Cont.) Monitor Recovery States

State	Meaning
shd_rec	Shadow recovery
shd_rec_fail	Shadow server waiting for access to a restart journal
shd_rec_icpl	Shadow getting next journal to recover from
shd_rec_cpl	Processed all journals for shadow recovery
catchup	Secondary is catching up with primary
standby	Server is declared as standby
active	Server is active
pri_act	Server is active as primary shadow
sec_act	Server is active as secondary shadow
remember	Primary is running without shadow secondary

8.2.36 Monitor Rejects

Displays the last `rtr_mt_rejected` message received by each running process. Table 8–6 gives the meaning of each column.

Example 8–36 Monitor Rejects

```

                                Rejected Transaction Summary
NODE: NODEA                      PROCESS: 20413894   Fri Apr 9 1999 10:26:14
-----
      Time           Pid    Chan   Reason  Status Text
-----
Fri Apr 9 10:18:43 20417266 client      0  No server available to handle
Fri Apr 9 10:17:47 20417274 server      0  Client aborted tx

```

Table 8–6 Monitor Rejects Fields

Field	Meaning
Time	Date and time when the <code>rtr_mt_rejected</code> message was received
Pid	ID of the process that received the message
Chan	Type of channel (client or server) that received the message
Reason	Reason field returned in the <code>rtr_status_data_t</code> buffer, if any
Status Text	Text describing the reject reason

8.2.37 Monitor Rejhst

Displays the last 10 `rtr_mt_rejected` messages received by the selected process. Always invoke this picture with the `/ID` qualifier. The transaction identifier associated with the rejected transaction can be displayed with the `SHOW PROCESS <id>/COUNTER=api_reject*` command. Table 8–7 shows the meaning of Rejhst columns.

Example 8–37 Monitor Rejhst

```

                                Rejected Transaction History
NODE: NODEA                      PROCESS: 38009A8B      Mon Mar  9 1999 10:26:14
-----
      Time              Chan   Reason   Status Text
-----
Mon Mar 15 18:06:06   client      0   Client aborted tx
Mon Mar 15 18:06:41   server      0   Normal successful completion
Mon Mar 15 18:06:41   client      0   Server aborted tx
-----

                                number of reject messages: 3
                                number of accept messages: 0
                                rejected / total txns (%): 100%

```

This display should be invoked with the `/ID` qualifier.

Table 8–7 Monitor Rejhst Fields

Field	Meaning
Time	Date and time when the <code>rtr_mt_rejected</code> message was generated
Chan	Type of channel (client or server) that received the message
Reason	Reason field returned in the <code>rtr_status_data_t</code> buffer, if any
Status Text	Text describing the reject reason

8.2.38 Monitor Response

Displays the elapsed time that a transaction has been active on the opened channels of a process. On the client, transaction duration is measured between the `rtr_start_tx` or `rtr_send_tx` call and the receipt of the final `rtr_mt_accepted` or `rtr_mt_rejected` message. A call to `rtr_reject_tx` also marks the end of a transaction. On the server, transaction duration is measured between receipt of an `rtr_mt_msg1` or `rtr_mt_msg1_uncertain` message and the receipt of the final `rtr_mt_rejected` message or `rtr_reject_tx` call. Accepted transaction end times are recorded when

RTR Monitoring

8.2 Standard Monitor Pictures

the server issues an `rtr_receive_message` call to request a new transaction for processing.

Example 8–38 Monitor Response

```

TRANSACTION DURATION AT 10:24:51 Fri Apr 9 1999

Process ID, Image Name      Client Response Time      Server Response Time
seconds 0---1---2---3---4  seconds 0---1---2---3---4
20413894  SERVER.EXE;4  0.000  3.670
20417266  RTR.EXE;75   2.200  3.440
20417274  SERVER.EXE;4  0.000  1.160

```

8.2.39 Monitor Rolequor

Displays for each facility the number of roles RTR sees as configured (CNF), reachable (RCH), and quorate (QRT), from the point of view of the routers and the backends. Compare Section 8.2.34.

Example 8–39 Monitor Rolequor

```

QUORUM COUNTS BY FACILITY Tue Dec 04 2001 14:32:48, NODE: NODEA

Facility name      Router View of          Backend View of
                   Backends Routers          Backends Routers
                   CNF RCH QRT  CNF RCH QRT  CNF RCH QRT  CNF RCH QRT
RTR$DEFAULT FACILITY  1  1  1  1  1  1  1  1  1  1  1  1
funds_transfer       1  0  0  0  0  0

```

8.2.40 Monitor Routers

Displays information on a router node. It gives an indication of the utilization of the router in terms of transactions and broadcasts routed through this node. Useful to monitor performance or locate problems. Uses counters in the Transaction Manager (TM) subsystem.

Example 8–40 Monitor Routers

```

ROUTER TRANSACTION COUNTERS AT 14:33:29  Fri Sep 08 2000
Node:      NODEA
Facility:  -ALL-

                Count      Rate      10  20  30  40  50  60  70  80  90 100
Starts:      116641      25.7
Enqueues:    116641      25.7
Commits:     116641      25.6
Aborts:       0          0.0

```

8.2.41 Monitor Routing

Displays statistics of transaction and broadcast traffic by facility. Rate is the number of transactions or broadcasts per second within the monitoring interval. A value in the No KR column indicates the absence of an appropriate key range server. A value in the NoDst column indicates the absence of an appropriate broadcast destination. Counts in these columns probably mean that a required server application is missing or perhaps that there is a problem with application configuration.

Example 8–41 Monitor Routing

```

ROUTING STATISTICS BY FACILITY  Tue Dec 04 2001 14:34:20, NODE: NODEA
Facility name                    Transactions          Broadcasts
                                Count   Rate NoKR Count   Rate NoDst
Total                            118489   39.2   0 68444   994.0   1
RTR$DEFAULT_FACILITY             118489   39.2   0 68444   994.0   1

```

8.2.42 Monitor Rscbe

Displays, by partition, the history of the most recent request-to-server messages issued to a backend from each router. The RSC calls column shows the message type, the Router column gives the router node name, the State column shows the partition state for messages to a router and the target state for messages from a router. T-delta is the elapsed time in seconds since the partition was established, and Seq_nr gives the partition sequence number or priority.

RTR Monitoring

8.2 Standard Monitor Pictures

Example 8–42 Monitor Rscbe

Most Recent RSC Dclsrv Calls History on Backend NODEA Thu Mar 4 1999,15:19:41

Partition name: RTR\$DEFAULT Partition Start Time: THU MAR 4 15:18:22 1999
Image Name: RTR.EXE

T-delta	RSC calls	Router	State	Seq_nr
0	send_dcl_to_master	nodez	wait_for_response	0
1	rcv_status_ok	nodez	rstart_rvy	1
1	send_dcl_to_master	nodez	rstart_rvy_incomp	1
1	rcv_status_ok	nodez	rstart_rvy	1
1	send_dcl_to_master	nodez	rstart_rvy_incomp	1
1	rcv_status_ok	nodez	active	1
1	send_dcl_to_other	node10	active	1
1	rcv_status_ok	node10	active	1

8.2.43 Monitor Stalls

Displays in real time any network links that are currently stalling (that is, waiting to transmit outbound traffic) and provides a history of the stalls encountered by the various links during their lifetime. The display shows:

- Node-to-node path of link analyzed
- The outgoing network message count per link
- The outgoing network message rate per link
- The number of bytes sent per link
- The number of link disconnects
- Total accumulated network write-completion wait time, in seconds
- Count of stalls between 1 and 3 seconds
- Count of stalls between 3 and 10 seconds
- Count of stalls between 10 and 30 seconds
- Count of stalls longer than 30 seconds
- Count of stalled network write completions

RTR Monitoring 8.2 Standard Monitor Pictures

Example 8–43 Monitor Stalls

```

NETWORK STALLS AT Fri Sep 08 2000 15:35:03, ON NODE: TR1
      Messages      Bytes  Link      Stalls
      Issued Rate    Sent Drops Secs <3s  <10s  <30s  >30s Totals
Total      5467 0.0 327148      2  33  23      1      0      0  24
TR1 -> TR1      29 0.0   3718      0   0   0      0      0      0   0
TR1 -> FE2     509 0.0  20707      0   4   4      0      0      0   4
TR1 -> BE1     303 0.0  13707      0   3   3      0      0      0   3
TR2 -> TR2     111 0.0  11682      0   0   0      0      0      0   0
TR2 -> BE1     504 0.0  22743      0  18   8      1      0      0   9
FE1 -> FE1      64 0.0   6645      0   0   0      0      0      0   0
FE1 -> FE2     373 0.0  18890      0   2   2      0      0      0   2
FE1 -> BE1     310 0.0  24487      0   0   0      0      0      0   0
FE2 -> FE2     231 0.0  18900      0   0   0      0      0      0   0
FE2 -> BE1     284 0.0  22503      1   1   1      0      0      0   1
FE2 -> TR1     536 0.0  28166      0   0   0      0      0      0   0
FE2 -> FE1     396 0.0  23643      0   0   0      0      0      0   0
BE1 -> BE1     355 0.0  28121      0   0   0      0      0      0   0
BE1 -> FE2     284 0.0  13014      1   0   0      0      0      0   0
BE1 -> TR2     515 0.0  27502      0   2   2      0      0      0   2
BE1 -> TR1     328 0.0  25698      0   1   1      0      0      0   1
BE1 -> FE1     335 0.0  17022      0   2   2      0      0      0   2

```

8.2.44 Monitor Stcalls

Displays the history of calls for a specific server transaction controller. Valid only when the application is using the C++ API.

Example 8–44 Monitor Stcalls

```

ORTR Call history monitor screen on node:rtrdoc          PID : -ALL-
Image: -ALL-                                           at 15:45:10 Mon Jul 16 2001
STC CurrentState :                                     #Of Partitions : 0
      PartitionName                                     Channel #
Calls      Channel #s          State   Msg/Event   Ch. used Status

```

8.2.45 Monitor Summary

Displays information about the channel, transaction, and system environment, including:

- For server channels:
 - Processes (number of processes hosting server channels)
 - Active (number of primary active server channels)

RTR Monitoring

8.2 Standard Monitor Pictures

- Secondary active (number of secondary active server channels)
- Standby (number of standby server channels)
- Other (number of server channels in states not counted above)
- All server channels (number of server channels in all states)
- For client channels:
 - Processes (number of processes hosting client channels)
 - Channels: number of client channels
- For all processes: Total processes: number of RTR application processes (clients and servers). To see separation by process, use MONITOR CHANNEL.
- For transaction counts: Active transactions (for each frontend, router, and backend role, displays counts of active transactions with node location and age (in days and clock time as dddd hh:mm:ss) of the oldest transaction)
- For RTR uptime by system: Elapsed time in days and clock time(ddd hh:mm:ss) since RTR was started on the given system, and the number of transactions and broadcasts processed to date.

Example 8–45 Monitor Summary

Environment Summary at 11:34:44 Wed Feb 18 2004
on node -ALL-

```
--Server channels-----      --Client channels-----
      Processes :      2          Processes :      1
      Active   :      2          Channels  :      1
Secondary active :      0
      Standby  :      0
      Other   :      0
All server channels :      2    Total processes :      2
Active transactions
      Backend  :      1          Oldest (on depth ) 0000 00:08:25
      Router   :      1          Oldest (on depth ) 0000 00:08:25
      Frontend :      1          Oldest (on depth ) 0000 00:08:25
```

(continued on next page)

RTR Monitoring 8.2 Standard Monitor Pictures

Example 8-45 (Cont.) Monitor Summary

by system	RTR uptime	Transactions				Broadcasts	
		As BE	As TR	As FE	Routed	Delivered	
mpeso	0004 20:14:00	179500	0	0	0	607	
depth	0004 20:14:07	179000	0	0	0	0	
onepaq	0013 01:13:19	0	11.93M	12.02M	609	0	
twopaq	0013 17:44:05	0	388170	300414	4	0	

8.2.46 Monitor System

Displays the state of critical resources within the RTR environment. If a resource has exceeded a predefined threshold, the picture displays a warning indicator.

Example 8-46 Monitor System

```
System Status at 10:27:51 Fri Apr 9 1999
node: NODEA

Resource          OK  Warning
Facility QUORUM states.....      x
JOURNAL free space.....  x
Link CONNECTS.....              x
Link traffic STALLS.....  x
FLOW control credits.....  x
PARTITION states.....  x
CALL Msg outstanding.....      x
Transaction QUEUES.....  x
Transaction REJECTS.....  x
Broadcast EVENT discards.....  x
```

For additional detail about a resource, monitor the appropriate subsystem. To customize threshold values, edit SYSTEM.MON. If viewing this page in a browser, follow the hyperlinks above.

RTR Monitoring

8.2 Standard Monitor Pictures

Table 8–8 lists the default thresholds.

Table 8–8 Default Thresholds

For this Resource:	A Warning Appears When:
Quorum	Any roles are inquorate
Journal	Journal free space is less than 30% of total
Link Connects	Any link is disconnected
Stalls	10 second stalls are greater than 1% of all messages sent
Flow	The wait is more than 1 second for 10% of the total credit requests
Partition	Any of the partitions are not in one of the following states: Standby, Active, Pri_act, or Sec_act
Call Msg	Any messages have been pending for more than 30 seconds
Queues	The transaction queue cannot be emptied within 10 seconds
Rejects	The number of rejects (non-user) is greater than 5% of the total transactions processed, or a reject (non-user) has occurred within the last 30 minutes
Event discards	The number of discards is greater than 5% of the total events sent

To customize threshold values, edit the file SYSTEM.MON.

8.2.47 Monitor Tps

Displays the transaction processing rate for processes on a specific node, with cumulative totals for all client and server processes. The display also provides a bar graph for each entry.

Example 8–47 Monitor Tps

```
TRANSACTION COMMITS BY PROCESS 14:12:48 Wed Nov 3 1999 on nodeA
                                Commits   Each # is 10tps
Node, Process ID & name        Absolute Rate/s  50  100  150  200  250  300
nodeA -ALL- -CLIENTS-          2401  45.0  ####
nodeA -ALL- -SERVERS-          2401  45.0  ####
nodeA 22941 smith_1             2401  45.0  ####
nodeA 22933 jones_1             2401  45.0  ####
```

8.2.48 Monitor Tpslo

Displays low end of the transaction processing rate for processes using RTR, with bar graphs. The display is intended for systems with throughput less than 10 tps.

Example 8-48 Monitor Tpslo

TRANSACTION COMMITS BY PROCESS 14:12:48 Wed Nov 3 1999 on nodeA.zko.dec.com

Node	ID	Process	Commits							
			Abs.	Rate	2	4	6	8	10	
nodeA	-ALL-	-CLIENTS-	5	2.0	##					
nodeA	-ALL-	-SERVERS-	5	2.0	##					
nodeA	22941	smith_1	10	4.0	####					

8.2.49 Monitor Traffic

Displays a list of links to other nodes. Shown for each link are: byte rate, packet rate, message rate and congestion, in both directions. Average packets per second is also shown. Uses counters in the Network I/O (NIO) subsystem.

Example 8-49 Monitor Traffic

LINK TRAFFIC Fri Sep 08 2000 14:38:08, NODE: -ALL-

	Bytes/sec		Packets/sec			Messages/sec		Congestion		
	Rcvd	Sent	Rcvd	Sent	Avrg	Rcvd	Sent	Count	Rate	Q'd
Total	13465.5	13213.3	123.8	121.2	239.1	53.3	53.3	35	0.0	0
NODEA -> NODEA	0.0	0.0	0.0	0.0	0.0	0.0	0.0	0	0.0	0
NODEA -> NODEB	10718.0	2705.8	95.1	27.5	118.9	24.9	27.2	28	0.0	0
NODEB -> NODEB	41.7	41.7	1.2	1.2	1.4	1.2	1.2	0	0.0	0
NODEB -> NODEA	2705.8	10465.8	27.5	92.5	118.8	27.2	24.9	7	0.0	0

8.2.50 Monitor Trans

Displays transaction state for transactions in a facility.

RTR Monitoring

8.2 Standard Monitor Pictures

Example 8–50 Monitor Trans

```
Monitoring transactions Wed Jan 09 2002 15:21:38, NODE: NODEA
Transaction ID (frontend)      Facility      FE-User      State
46d01f10,0,0,0,0,baa09daa,abf10001 RTR$DEFAULT_FACILITY RTRCSV_T.1  voting

Transaction ID (router)       Facility      FE-User      State
46d01f10,0,0,0,0,baa09daa,abf10001 RTR$DEFAULT_FACILITY RTRCSV_T.1  voting

Transaction ID (backend)      Facility      FE-User      State
46d01f10,0,0,0,0,baa09daa,abf10001 RTR$DEFAULT_FACILITY RTRCSV_T.1  receiving
```

8.2.51 Monitor Upstream

Displays flow-control induced traffic stalls upstream from the controlling backend, between the frontend and the router, and between the router and the backend. Upstream traffic runs towards the backend.

Example 8–51 Monitor Upstream

```
FLOW CONTROL UPSTREAM STALLS BY NODE & FACILITY Mon Jul 16 2001 15:42:25, Node:
Node & Facility      Txn traffic      Bdcst traffic
fe->tr      tr->be      tr->be
reqs stall  reqs stall  reqs stall      Router used
rtrdoc     Test
```

8.2.52 Monitor V2calls

Displays calls made by applications to the Version 2.0 API.

Example 8-52 Monitor V2calls

RTR V2 system service calls, Node: NODEA , PID: 00000000, Process name: -ALL-
Image: -ALL- 13:09:18 5-MAR-1999

	Accept	Reject	Success	Failure	Outstng	Calls
dcl_tx_prc/server	3	0	4	0	0	4
dcl_tx_prc/req.	1					
dcl_tx_prc/shut.	0					
start_tx	1	0	1	0	0	1
start_tx /timeout	0					
enq_tx	1	0	50395	0	0	50395
enq_tx /broadcast	25187					
enq_tx /reply	25207					
deq_tx	50381	0	50391	0	2	50393
deq_tx /reply	12					
commit_tx	1	0	1	0	0	1
abort_tx	0	0	0	0	0	0
vote_tx /commit	25187	0	25189	0	0	25189
vote_tx /abort	0					
vote_tx /forget	2					

8.2.53 Monitor Wq_facility

Displays the state of the ACP channel wait queues by facility.

Example 8-53 Monitor Wq_facility

WAITQ STATISTICS BY FACILITY Mon Jul 26 2004 14:09:46 mpeso -ALL-

		Servers		Clients	
Current	Maximum	Timestamp	Current	Maximum	Timestamp
451288	451288	26-Jul-2004 14:09	0	0	

		Servers		Clients	
Node	Facility	Current	Maximum	Current	Maximum
mpeso	f1	451288	451288	0	0

8.2.54 Monitor Wq_process

Displays the state of the ACP channel wait queues by process.

RTR Monitoring

8.2 Standard Monitor Pictures

Example 8-54 Monitor Wq_process

```

WAITQ STATISTICS BY PROCESS Mon Jul 26 2004 14:10:04 mpeso ID: -ALL-

      Servers
Current Maximum Timestamp      Clients
451288  451288 26-Jul-2004 14:09      0
                                         Maximum Timestamp
                                         0

Node Proc. Id Process Name      Servers
mpeso 20409E6A GAISFORD_126      Current Maximum
                                         Clients
                                         Maximum
                                         0
                                         0

```

8.2.55 Monitor XA

Displays information about XA call activity when using XA with RTR.

Example 8-55 Monitor XA

```

RTR XA Calls Node: nodea.zko PID: -ALL- Process name: -ALL-
Image: -ALL- 11:42:06 Tue 6-Apr-1999

XA Verb Name Calls Success Readonly Failure
open 0 0 0 0
close 0 0 0 0
start 0 0 0 0
end 0 0 0 0
prepare 0 0 0 0
commit 0 0 0 0
rollback 0 0 0 0
recovery 0 0 0 0

Rate 0 2 4 6 8 10 12 14 16 18 20 Active
txn starts 0.0 0

```

RTR Commands

RTR commands can be invoked from the RTR web browser interface or with the RTR CLI. RTR C API calls can also be invoked from the RTR CLI to facilitate application testing. For example, client applications can be tested before the corresponding server applications have been written by manually entering the server's C API calls, and manual tests can be done between clients and servers.

RTR commands include those used in developing applications as well as commands that let you monitor and manage the operation of a production system. See Section 1.3 for instructions on how to start using the RTR web browser and CLI interfaces, and see the *HP Reliable Transaction Router Getting Started* manual for an example of a manual demonstration of sending data between a client and a server.

9.1 Introduction

The commands that invoke the RTR API calls are similar to the call names. For example, the `rtr_accept_tx()` call is invoked using `CALL RTR_ACCEPT_TX` at the CLI level.

Where possible, command qualifiers have been given the same names as the parameters to the API calls. See the *HP Reliable Transaction Router C Application Programmer's Reference Manual* for details about the parameters to API calls.

Most commands can be issued on remote nodes by using the `/NODE=node-list` or `/CLUSTER` qualifiers, or by preceding them with the `SET ENVIRONMENT` command to specify nodes where commands are to be executed. Commands such as `DEFINE KEY` are intended for local execution only.

Output from each command can be redirected to another device or file using the `/OUTPUT` qualifier.

RTR Commands

9.1 Introduction

Because the RTR command utility keeps parameter checking to a minimum, “what if” questions can be answered quickly without having to write test programs.

Note

In a mixed RTR Version 3 and Version 4 environment, you can execute commands remotely with the /NODE qualifier.

9.2 RTR Command Reference

This section describes each command in the RTR command utility.

The command descriptions are presented in alphabetical order.

ADD FACILITY

See `CREATE FACILITY`; `ADD FACILITY` is retained for compatibility reasons only.

CALL RTR_ACCEPT_TX

CALL RTR_ACCEPT_TX

The **CALL RTR_ACCEPT_TX** command causes a command server to execute the `rtr_accept_tx()` routine and to display the returned status.

Note

This command is not available in the RTR web browser interface.

Format

CALL RTR_ACCEPT_TX

Command Qualifiers	Defaults
/CHANNEL_NAME=channel-name	/CHANNEL_NAME=RTR\$DEFAULT_CHANNEL
/CLUSTER	/NOCLUSTER
/FORGET	/NOFORGET
/INDEPENDENT	/NOINDEPENDENT
/NODE[=node-list]	/NODE=default-node
/OUTPUT[=filespec]	/OUTPUT=stdout
/REASON[=reason]	/REASON=0

Description

The **CALL RTR_ACCEPT_TX** command causes a command server to call the `rtr_accept_tx()` routine using values supplied on the command line.

The numeric status returned from the call is then converted to its textual representation and displayed.

The `rtr_accept_tx()` routine itself is described in the C Application Programmer's Reference Manual.

The prototype of `rtr_accept_tx()` is:

```
rtr_status_t  rtr_accept_tx (
                rtr_channel_t  channel,
                rtr_acc_flag_t  flags,
                rtr_reason_t    reason
                ) ;
```

Table 9–1 shows the correspondence between values you supply on the command line and the C language parameter values produced and used for the call.

Table 9–1 Parameters for rtr_accept_tx

C Parameter Name	C Parameter Value	Command Line Specification
channel		/CHANNEL_NAME=name
flags	RTR_NO_FLAGS	[none] [D]
	RTR_F_ACC_FORGET	/FORGET
reason	RTR_NO_REASON	/NOREASON [D]
	reason_value	/REASON=reason_value

Issuing the CALL RTR_ACCEPT_TX command in preference to using the /ACCEPT qualifier with the CALL RTR_SEND_TO_SERVER or CALL RTR_REPLY_TO_CLIENT commands is only necessary when specifying an acceptance "reason" other than the default value of zero (using the /REASON qualifier).

Qualifiers

/CHANNEL_NAME=channel_name
/CHANNEL_NAME=RTR\$DEFAULT_CHANNEL

Specifies the channel for which the operation is to be performed.

The command server uses a combination of the channel name and the window from which the call was issued to uniquely identify which channel to use.

channel_name is not case sensitive.

The default for channel_name is RTR\$DEFAULT_CHANNEL.

/CLUSTER
/NOCLUSTER (D)

Specifies that the command is executed on all the nodes in the cluster.

If neither /NODE nor /CLUSTER is specified, the command is executed on the nodes specified by the latest SET ENVIRONMENT command. If no SET ENVIRONMENT command has been entered, the command is executed only on the node where the command was issued.

CALL RTR_ACCEPT_TX

Note

In environments that do not support remote command capability, the `/CLUSTER` qualifier causes the relevant command to be executed on the local node only.

/FORGET

/NOFORGET

Use `/FORGET` to specify the `flags` parameter as `RTR_F_ACC_FORGET` in the call `rtr_accept_tx()`.

The default value for `/FORGET` is `/NOFORGET`, which causes the command server to use the value `RTR_NO_FLAGS` for the `flags` parameter in the call to `rtr_accept_tx()`.

/INDEPENDENT

/NOINDEPENDENT

Use the `/INDEPENDENT` qualifier to specify the `flags` parameter `RTR_F_ACC_INDEPENDENT` in the call to `rtr_accept_tx()`.

/NODE[=node-list]

/NODE=default-node (D)

Specifies that the command is executed on all nodes specified in `node-list`. If `node-list` is omitted, the command is executed only on the node where the command was issued.

/OUTPUT[=filespec]

/OUTPUT=stdout (D)

Specifies that the resulting information is written to the file `filespec`. If `/OUTPUT` or `filespec` is omitted, the standard or default output is used.

/REASON[=reason]

/REASON=0

Use `/REASON` to supply a value for the `reason` parameter in the call to `rtr_accept_tx()`.

The default value for `/REASON` is 0, which causes the command server to use the value `RTR_NO_REASON` for the `reason` parameter in the call to `rtr_accept_tx()`.

Related commands

- CALL RTR_OPEN_CHANNEL
- CALL RTR_REJECT_TX

Examples

Accept the current transaction with a reason of 42.

```
RTR> CALL RTR_ACCEPT_TX /REASON=42
%RTR-S-OK, normal successful completion
```

CALL RTR_BROADCAST_EVENT

CALL RTR_BROADCAST_EVENT

The **CALL RTR_BROADCAST_EVENT** command causes a command server to execute the `rtr_broadcast_event()` routine and to display the returned status.

Note

This command is not available in the RTR web browser interface.

Format

CALL RTR_BROADCAST_EVENT [message-field1] [,message-field2,...]

Parameters

[message-field1] [,message-field2...]

Specify the message to be sent (if any) as one or more comma-separated parameter values. You can use the `/TYPE_OF_DATA` and `/LENGTH_OF_DATA` positional qualifiers on each parameter value to specify the data type and length of each field.

Command Qualifiers

`/CHANNEL_NAME=channel-name`
`/CLUSTER`
`/EVENT_NUMBER=evtnum`
`/FORMAT=fmt-string`
`/LENGTH_OF_FIELD=msg length`
`/NODE[=node-list]`
`/OUTPUT[=filespec]`
`/RECIPIENT_SPEC=rcpspc`
`/TYPE_OF_DATA=data type`

Defaults

`/CHANNEL_NAME=RTR$DEFAULT_CHANNEL`
`/NOCLUSTER`
None
`/NOFORMAT`
Depends on data type.
`/NODE=default-node`
`/OUTPUT=stdout`
`/NORECIPIENT_SPEC`
`/TYPE_OF_DATA=STRING`

Description

The **CALL RTR_BROADCAST_EVENT** command causes a command server to call the `rtr_broadcast_event()` routine using values supplied on the command line.

The numeric status returned from the call is then converted to its textual representation and displayed.

CALL RTR_BROADCAST_EVENT

The `rtr_broadcast_event()` routine itself is described in the *HP Reliable Transaction Router C Application Programmer's Reference Manual*.

The prototype of `rtr_broadcast_event()` is:

```
rtr_status_t rtr_broadcast_event (
    rtr_channel_t    channel,
    rtr_bro_flag_t   flags,
    rtr_msgbuf_t     pmsg,
    rtr_msglen_t     msglen,
    rtr_evtnum_t     evtnum,
    rtr_rcpspc_t     rcpspc,
    rtr_msgfmt_t     msgfmt
) ;
```

Table 9–2 shows the correspondence between values you supply on the command line and the C language parameter values produced and used for the call.

Table 9–2 Parameters for `rtr_broadcast_event`

C Parameter Name	C Parameter Value	Command Line Specification
channel		/CHANNEL_NAME=name
flags	RTR_NO_FLAGS	[none] [D]
pmsg, msglen, msgfmt ¹		[message definition parameter list with positional qualifiers]
evtnum	42	/EVENT_NUMBER=42
rcpspc	"workstat*"	/RECIPIENT_SPEC= "workstat*"

¹ The actual values used for `pmsg`, `msglen` and `msgfmt` are based upon the message definition you specify as a command line parameter.

The command server uses message data specified as command line parameter values to generate a record containing the message data (for the `pmsg` parameter), the message length (for the `msglen` parameter), and a record type description (for the `msgfmt` parameter).

CALL RTR_BROADCAST_EVENT

Qualifiers

/CHANNEL_NAME=channel-name

/CHANNEL_NAME=RTR\$DEFAULT_CHANNEL

Specifies the channel for which the operation is to be performed.

The command server uses a combination of the channel name and the window from which the call was issued to uniquely identify which channel to use.

channel_name is not case sensitive.

The default for channel-name is RTR\$DEFAULT_CHANNEL.

/CLUSTER

/NOCLUSTER (D)

Specifies that the command is executed on all the nodes in the cluster.

If neither /NODE nor /CLUSTER is specified, the command is executed on the nodes specified by the latest SET ENVIRONMENT command. If no SET ENVIRONMENT command has been entered, the command is executed only on the node where the command was issued.

Note

In environments that do not support remote command capability, the /CLUSTER qualifier causes the relevant command to be executed on the local node only.

/EVENT_NUMBER=user-event-number

The user event number associated with this broadcast, in the range of RTR_EVTNUM_USERBASE to RTR_EVTNUM_USERMAX (i.e. 0 to 250).

/FORMAT[=fmt-string]

/NOFORMAT (D)

Specifies that a format string should be sent with this message.

If /FORMAT is specified without fmt-string, RTR automatically generates a format string. The format string is generated using the parameters given for the qualifiers /SIGNED, /UNSIGNED, /STRING and /LENGTH. The following table shows permitted values for these qualifiers when using /FORMAT without fmt-string.

Table 9–3 Generated Format Strings

Data Type	With /LENGTH=	With /NOLENGTH
STRING	=n, "%nC"	"%nC" where n=strlen(string)
SIGNED	=1, "%SB"	"%SL"
SIGNED	=2, "%SW"	"%SL"
SIGNED	=4, "%SL"	"%SL"
UNSIGNED	=1, "%UB"	"%SL"
UNSIGNED	=2, "%UW"	"%SL"
UNSIGNED	=4, "%UL"	"%SL"

Refer to the *HP Reliable Transaction Router C Application Programmer's Reference Manual*, section "Defining a Message Format Description" for information on constructing a `fmt-string` parameter.

/LENGTH_OF_FIELD=field-length

Enter the size of the message field that you want to define. The default for string types is the length of the message entered, plus one (for the zero termination byte). The default for signed and unsigned types is four. This is a positional qualifier; it must immediately follow the message field that it refers to.

/NODE[=node-list]

/NODE=default-node (D)

Specifies that the command is executed on all nodes specified in `node-list`. If `node-list` is omitted, the command is executed only on the node where the command was issued.

/OUTPUT[=filespec]

/OUTPUT=stdout (D)

Specifies that the resulting information is written to the file `filespec`. If `/OUTPUT` or `filespec` is omitted, the standard or default output is used.

/RECIPIENT_SPEC=rcpspc

Enter a string specifying the recipient name. The wildcard characters asterisk (*) and question mark (?) are permitted.

`rcpspc` is case sensitive, but defaults to the case-insensitive channel name if not explicitly defined.

CALL RTR_BROADCAST_EVENT

/TYPE_OF_DATA=STRING | SIGNED | UNSIGNED

/TYPE_OF_DATA=STRING (D)

Enter the data type of the message field that you want to define. The default is the string type. This is a positional qualifier; it must immediately follow the message field that it refers to.

Examples

This command broadcasts user event number 23 to all default recipients. The message in quotes is sent with the broadcast.

```
RTR> CALL RTR_BROADCAST_EVENT /EVENT_NUMBER=23 "Dollar is up"  
%RTR-S-OK, Normal successful completion
```

The following command broadcasts user event number 24 to all recipients whose /RECIPIENT_SPEC matches the DEALER? string (that is, DEALER1, DEALER2, DEALERx). Note that only the event is broadcast; there is no associated message.

```
RTR> CALL RTR_BROADCAST_EVENT /EVENT=24/RECIPIENT_SPEC=DEALER?  
%RTR-S-OK, Normal successful completion
```

The following example shows a broadcast message containing two fields. The first field is of type unsigned, entered as a hexadecimal number; the second field is of type string.

```
RTR> CALL RTR_BROADCAST_EVENT /EVENT=24 0xFA9BC0 /TYPE_OF_  
DATA=UNSIGNED/LENGTH=8,"This field of the message is a string"  
%RTR-S-OK, Normal successful completion
```

CALL RTR_CLOSE_CHANNEL

The **CALL RTR_CLOSE_CHANNEL** command causes a command server to execute the `rtr_close_channel()` routine and to display the returned status.

Note

This command is not available in the RTR web browser interface.

Format

CALL RTR_CLOSE_CHANNEL

Command Qualifiers	Defaults
/CHANNEL_NAME=channel-name	/CHANNEL_NAME=RTR\$DEFAULT_CHANNEL
/CLUSTER	/NOCLUSTER
/IMMEDIATE	/IMMEDIATE=RTR_F_CLO_IMMEDIATE
/NODE[=node-list]	/NODE=default-node
/OUTPUT[=filespec]	/OUTPUT=stdout

Description

The **CALL RTR_CLOSE_CHANNEL** command causes a command server to call the `rtr_close_channel()` routine using values supplied on the command line.

The numeric status returned from the call is then converted to its textual representation and displayed.

The `rtr_close_channel()` routine itself is described in the C Application Programmer's Reference Manual.

The prototype of `rtr_close_channel()` is:

```
rtr_status_t  rtr_close_channel (
                rtr_channel_t      channel,
                rtr_clo_flag_t     flags
                ) ;
```

Table 9–4 shows the correspondence between values you supply on the command line and the C language parameter values produced and used for the call.

CALL RTR_CLOSE_CHANNEL

Table 9–4 Parameters for rtr_close_channel

C Parameter Name	C Parameter Value	Command Line Specification
channel		/CHANNEL_NAME=name
flags	RTR_NO_FLAGS	[none] [D]

Qualifiers

/CHANNEL_NAME=channel_name

/CHANNEL_NAME=RTR\$DEFAULT_CHANNEL

Specifies the channel for which the operation is to be performed.

The command server uses a combination of the channel name and the window from which the call was issued to uniquely identify which channel to use.

channel_name is not case sensitive.

The default channel name is RTR\$DEFAULT_CHANNEL.

You may close all the channels belonging to a window using CLOSE CHANNEL/CHANNEL_NAME=*

/CLUSTER

/NOCLUSTER (D)

Specifies that the command is executed on all the nodes in the cluster.

If neither /NODE nor /CLUSTER is specified, the command is executed on the nodes specified by the latest SET ENVIRONMENT command. If no SET ENVIRONMENT command has been entered, the command is executed only on the node where the command was issued.

Note

In environments that do not support remote command capability, the /CLUSTER qualifier causes the relevant command to be executed on the local node only.

/IMMEDIATE

/IMMEDIATE=RTR_F_CLO_IMMEDIATE (D)

Specifies the closing of a channel immediately without sending a transaction acknowledgement.

CALL RTR_CLOSE_CHANNEL

/NODE[=node-list]

/NODE=default-node (D)

Specifies that the command is executed on all nodes specified in node-list. If node-list is omitted, the command is executed only on the node where the command was issued.

/OUTPUT[=filespec]

/OUTPUT=stdout (D)

Specifies that the resulting information is written to the file filespec. If /OUTPUT or filespec is omitted, the standard or default output is used.

Examples

This command closes the RTR\$DEFAULT_CHANNEL.

```
RTR> CALL RTR_CLOSE_CHANNEL
%RTR-S-OK, Normal successful completion
```

This command closes the channel named CLIENT1.

```
RTR> CALL RTR_CLOSE_CHANNEL/CHANNEL_NAME=CLIENT1
%RTR-S-OK, Normal successful completion
```

CALL RTR_ERROR_TEXT

CALL RTR_ERROR_TEXT

The **CALL RTR_ERROR_TEXT** command causes a command server to execute the `rtr_error_text()` routine and to display the returned error text.

Note

This command is not available in the RTR web browser interface.

Format

CALL RTR_ERROR_TEXT

Command Qualifiers
/OUTPUT[=filespec]
/STATUS=status-code

Defaults
/OUTPUT=stdout
None

Description

The **CALL RTR_ERROR_TEXT** command causes a command server to call the `rtr_error_text()` routine using the value supplied on the command line.

The `rtr_error_text()` routine itself is described in the C Application Programmer's Reference Manual.

The prototype of `rtr_error_text()` is:

```
char *rtr_error_text (
    rtr_status_t sts
);
```

Table 9-5 shows the correspondence between values you supply on the command line and the C language parameter values produced and used for the call.

Table 9-5 Parameters for `rtr_error_text`

C Parameter Name	Parameter Value	Command Line Specification
sts	42	42 (parameter)

Qualifiers

/OUTPUT[=filespec]

/OUTPUT=stdout (D)

Specifies that the resulting information is written to the file filespec. If /OUTPUT or filespec is omitted, the standard or default output is used.

/STATUS=status-code

No default

Specifies the sts parameter in the rtr_request_info() call.

Examples

This command shows the text associated with error number 4849722.

```
RTR> CALL RTR_ERROR_TEXT /STATUS=4849722
error text      normal successful completion
```

CALL RTR_EXT_BROADCAST_EVENT

CALL RTR_EXT_BROADCAST_EVENT

The **CALL RTR_EXT_BROADCAST_EVENT** command causes a command server to execute the `rtr_ext_broadcast_event()` routine and to display the returned status. A timeout can be supplied to eliminate long waits that may be seen with the similar call `RTR_BROADCAST_EVENT`.

Note

This command is not available in the RTR web browser interface.

Format

```
CALL RTR_EXT_BROADCAST_EVENT [message-field1] [,message-field2,...]
```

Parameters

[message-field1] [,message-field2...]

Specify the message to be sent (if any) as one or more comma-separated parameter values. You can use the `/TYPE_OF_DATA` and `/LENGTH_OF_DATA` positional qualifiers on each parameter value to specify the data type and length of each field.

Command Qualifiers

`/CHANNEL_NAME=channel-name`
`/CLUSTER`
`/EVENT_NUMBER=evtnum`
`/FORMAT=fmt-string`
`/LENGTH_OF_FIELD=msg length`
`/NODE=[node-list]`
`/OUTPUT=[filespec]`
`/RECIPIENT_SPEC=rcpspc`
`/TIMEOUTMS=timeout`
`/TYPE_OF_DATA=data type`

Defaults

`/CHANNEL_NAME=RTR$DEFAULT_CHANNEL`
`/NOCLUSTER`
None
`/NOFORMAT`
Depends on data type.
`/NODE=default-node`
`/OUTPUT=stdout`
`/NORECIPIENT_SPEC`
None
`/TYPE_OF_DATA=STRING`

Description

The **CALL RTR_EXT_BROADCAST_EVENT** command causes a command server to call the `rtr_ext_broadcast_event()` routine using values supplied on the command line. In some circumstances, a broadcast event call can wait a long time if RTR runs out of channel credits; it may seem that the application is hanging. To eliminate such a wait, the user can specify a timeout value from

CALL RTR_EXT_BROADCAST_EVENT

which the function will return an `RTR_STS_TIMEOUT` status if RTR is unable to issue the broadcast message within the specified broadcast period.

The numeric status returned from the call is converted to its textual representation and displayed.

The `rtr_ext_broadcast_event()` routine itself is described in the C Application Programmer's Reference Manual.

The prototype of `rtr_ext_broadcast_event()` is:

```
rtr_status_t rtr_ext_broadcast_event (
    rtr_channel_t    channel,
    rtr_bro_flag_t   flags,
    rtr_msgbuf_t     pmsg,
    rtr_msglen_t     msglen,
    rtr_evtnum_t     evtnum,
    rtr_rcpspc_t     rcpspc,
    rtr_msgfmt_t     msgfmt,
    rtr_timeoutms_t timeoutms
) ;
```

Table 9–6 shows the correspondence between values you supply on the command line and the C language parameter values produced and used for the call.

Table 9–6 Parameters for `rtr_ext_broadcast_event`

C Parameter Name	C Parameter Value	Command Line Specification
channel		/CHANNEL_NAME=name
flags	RTR_NO_FLAGS	[none] [D]
pmsg, msglen, msgfmt ¹		[message definition parameter list with positional qualifiers]
evtnum	42	/EVENT_NUMBER=42
rcpspc	"workstat*"	/RECIPIENT_SPEC= "workstat*"
timeoutms		/TIMOUTMS=1000 (1 sec.)

¹ The actual values used for `pmsg`, `msglen` and `msgfmt` are based upon the message definition you specify as a command line parameter.

The command server uses message data specified as command line parameter values to generate a record containing the message data (for the `pmsg`

CALL RTR_EXT_BROADCAST_EVENT

parameter), the message length (for the msglen parameter), and a record type description (for the msgfmt parameter).

Qualifiers

/CHANNEL_NAME=channel-name

/CHANNEL_NAME=RTR\$DEFAULT_CHANNEL

Specifies the channel for which the operation is to be performed.

The command server uses a combination of the channel name and the window from which the call was issued to uniquely identify which channel to use.

channel_name is not case sensitive.

The default for channel-name is RTR\$DEFAULT_CHANNEL.

/CLUSTER

/NOCLUSTER (D)

Specifies that the command is executed on all the nodes in the cluster.

If neither /NODE nor /CLUSTER is specified, the command is executed on the nodes specified by the latest SET ENVIRONMENT command. If no SET ENVIRONMENT command has been entered, the command is executed only on the node where the command was issued.

Note

In environments that do not support remote command capability, the /CLUSTER qualifier causes the relevant command to be executed on the local node only.

/EVENT_NUMBER=user-event-number

The user event number associated with this broadcast, in the range of RTR_EVTNUM_USERBASE to RTR_EVTNUM_USERMAX (i.e. 0 to 250).

/FORMAT[=fmt-string]

/NOFORMAT (D)

Specifies that a format string should be sent with this message.

If /FORMAT is specified without fmt-string, RTR automatically generates a format string. The format string is generated using the parameters given for the qualifiers /SIGNED, /UNSIGNED, /STRING and /LENGTH. The following table shows permitted values for these qualifiers when using /FORMAT without fmt-string.

Table 9–7 Generated Format Strings

Data Type	With /LENGTH=	With /NOLENGTH
STRING	=n, "%nC"	"%nC" where n=strlen(string)
SIGNED	=1, "%SB"	"%SL"
SIGNED	=2, "%SW"	"%SL"
SIGNED	=4, "%SL"	"%SL"
UNSIGNED	=1, "%UB"	"%SL"
UNSIGNED	=2, "%UW"	"%SL"
UNSIGNED	=4, "%UL"	"%SL"

Refer to the *HP Reliable Transaction Router C Application Programmer's Reference Manual*, section "Defining a Message Format Description" for information on constructing a `fmt-string` parameter.

/LENGTH_OF_FIELD=field-length

Enter the size of the message field that you want to define. The default for string types is the length of the message entered, plus one (for the zero termination byte). The default for signed and unsigned types is four. This is a positional qualifier; it must immediately follow the message field that it refers to.

/NODE[=node-list]

/NODE=default-node (D)

Specifies that the command is executed on all nodes specified in `node-list`. If `node-list` is omitted, the command is executed only on the node where the command was issued.

/OUTPUT[=filespec]

/OUTPUT=stdout (D)

Specifies that the resulting information is written to the file `filespec`. If `/OUTPUT` or `filespec` is omitted, the standard or default output is used.

/RECIPIENT_SPEC=rcpspc

Enter a string specifying the recipient name. The wildcard characters asterisk (*) and question mark (?) are permitted.

`rcpspc` is case sensitive, but defaults to the case-insensitive channel name if not explicitly defined.

CALL RTR_EXT_BROADCAST_EVENT

/TIMOUTMS=msec

Specifies a value in milliseconds for the timeout. RTR returns an error message if RTR is unable to issue the broadcast message within the specified timeout period.

/TYPE_OF_DATA=STRING | SIGNED | UNSIGNED

/TYPE_OF_DATA=STRING (D)

Enter the data type of the message field that you want to define. The default is the string type. This is a positional qualifier; it must immediately follow the message field that it refers to.

Examples

The following command broadcasts user event number 40 to all recipients whose /RECIPIENT_SPEC matches the TRADER? string (where ? represents a wildcard), but times out after 1 second if traffic congestion prevents the broadcast.

```
RTR> CALL RTR_EXT_BROADCAST_EVENT /EVENT=40-  
RTR /RECIPIENT_SPEC=TRADER?/TIMOUTMS=1000  
%RTR-S-OK, Normal successful completion
```

CALL RTR_GET_TID

The **CALL RTR_GET_TID** command causes a command server to execute the `rtr_get_tid()` routine and to display the returned status.

Note

This command is not available in the RTR web browser interface.

Format

```
CALL RTR_GET_TID
```

Command Qualifiers	Defaults
/CHANNEL_NAME=channel-name	/CHANNEL_NAME=RTR\$DEFAULT_CHANNEL
/CLUSTER	/NOCLUSTER
/NODE[=node-list]	/NODE=default-node
/OUTPUT[=filespec]	/OUTPUT=stdout

Description

The **CALL RTR_GET_TID** command causes a command server to call to the `rtr_get_tid()` routine using values supplied on the command line.

The transaction ID returned from the call is converted to its textual representation and displayed.

The `rtr_get_tid()` routine itself is described in the C Application Programmer's Reference Manual.

The prototype of `rtr_get_tid()` is:

```

rtr_status_t  rtr_get_tid (
                rtr_channel_t      channel,
                rtr_tid_flag_t     flags,
void*         ptid
                ) ;

```

Table 9–8 shows the correspondence between values you supply on the command line and the C language parameter values produced and used for the call.

CALL RTR_GET_TID

Table 9–8 Parameters for rtr_get_tid

C Parameter Name	Parameter Value	Command Line Specification
channel		/CHANNEL_NAME=name
flags	RTR_NO_FLAGS	[none] [D]

Qualifiers

/CHANNEL_NAME=channel_name

/CHANNEL_NAME=RTR\$DEFAULT_CHANNEL

Specifies the channel for which the operation is to be performed.

The command server uses a combination of the channel name and the window from which the call was issued to uniquely identify which channel to use.

The default channel name is RTR\$DEFAULT_CHANNEL.

/CLUSTER

/NOCLUSTER (D)

Specifies that the command is executed on all the nodes in the cluster.

If neither /NODE nor /CLUSTER is specified, the command is executed on the nodes specified by the latest SET ENVIRONMENT command. If no SET ENVIRONMENT command has been entered, the command is executed only on the node where the command was issued.

Note

In environments that do not support remote command capability, the /CLUSTER qualifier causes the relevant command to be executed on the local node only.

/NODE[=node-list]

/NODE=default-node (D)

Specifies that the command is executed on all nodes specified in node-list. If node-list is omitted, the command is executed only on the node where the command was issued.

/OUTPUT[=filespec]

/OUTPUT=stdout (D)

Specifies that the resulting information is written to the file filespec. If /OUTPUT or filespec is omitted, the standard or default output is used.

Examples

This command shows the transaction ID active on channel CLIENT1.

```
RTR> CALL RTR_GET_TID/CHANNEL=CLIENT1
%RTR-S-OK, normal successful completion
tid:          e100b810,0,0,0,0,3bc5,6eb02001
```

CALL RTR_GET_USER_CONTEXT

CALL RTR_GET_USER_CONTEXT

The **CALL RTR_GET_USER_CONTEXT** command causes a command server to execute the `rtr_get_user_context()` routine and to display the optional user-defined context associated with the specified RTR channel.

Note

This command is not available in the RTR web browser interface.

Format

```
CALL RTR_GET_USER_CONTEXT
```

Command Qualifiers

```
/CHANNEL_NAME=channel-name  
/NODE[=node-list]  
/OUTPUT[=filespec]
```

Defaults

```
/CHANNEL_NAME=RTR$DEFAULT_CHANNEL  
/NODE=default-node  
/OUTPUT=stdout
```

Description

The **CALL RTR_GET_USER_CONTEXT** command causes a command server to call the `rtr_get_user_context()` routine using values supplied on the command line.

The `rtr_get_user_context()` routine itself is described in the *HP Reliable Transaction Router C Application Programmer's Reference Manual*.

The prototype of `rtr_get_user_context()` is:

```
rtr_usrctx_t    rtr_get_user_context (
                rtr_channel_t    channel,
                ) ;
```

Table 9–9 shows the correspondence between values you supply on the command line and the C language parameter values produced and used for the call.

Table 9–9 Parameters for `rtr_get_user_context`

C Parameter Name	Parameter Value	Command Line Specification
channel		/CHANNEL_NAME=name

Qualifiers

/CHANNEL_NAME=channel_name

/CHANNEL_NAME=RTR\$DEFAULT_CHANNEL

Specifies the channel for which the operation is to be performed.

The command server uses a combination of the channel name and the window from which the call was issued to uniquely identify which channel to use.

The default channel name is RTR\$DEFAULT_CHANNEL.

/NODE[=node-list]

/NODE=default-node (D)

Specifies that the command is executed on all nodes specified in node-list. If node-list is omitted, the command is executed only on the node where the command was issued.

/OUTPUT[=filespec]

/OUTPUT=stdout (D)

Specifies that the resulting information is written to the file filespec. If /OUTPUT or filespec is omitted, the standard or default output is used.

Examples

This command shows setting and then retrieving the user context on channel CLIENT1.

```
RTR> CALL RTR SET USER CONTEXT/CHANNEL=CLIENT1/CONTEXT=567
%RTR-S-OK, normal successful completion
RTR> CALL RTR GET USER CONTEXT/CHANNEL=CLIENT1
User context for channel CLIENT1: 567
```

CALL RTR_OPEN_CHANNEL

CALL RTR_OPEN_CHANNEL

The **CALL RTR_OPEN_CHANNEL** command causes a command server to execute the `rtr_open_channel()` routine and to display the returned status.

Note

This command is not available in the RTR web browser interface.

Format

CALL RTR_OPEN_CHANNEL

Command Qualifiers

/ACCEPT_EXPLICIT
/ACCESS=access
/BE_CALL_OUT
/CHANNEL_NAME=channel-name
/CLIENT
/CLUSTER
/[NO]CONCURRENT
/EVENTS(=event-nr-list)
/EXPLICIT_START
/FACILITY_NAME[=facility-name]
/FOREIGN_TM[=tm_id]
/HIGH_BOUND=high-bound
/KEYn=keysegdesc
/LENGTH_OF_FIELD=key-field-length
/LOW_BOUND=low-bound
/NODE[=node-list]
/OFFSET_OF_KEY=offset
/OUTPUT[=filespec]
/PARTITION_NAME=partition-name
/PREPARE_EXPLICIT
/RECEIVE_REPLIES
/RECIPIENT_NAME=rcpnam
/[NO]RECOVERY
/SERVER
/SHADOW
/[NO]STANDBY
/STRICT_ORDERING
/TR_CALL_OUT
/TYPE_OF_FIELD=key-field-type

Defaults

/NOACCEPT_EXPLICIT
/NOACCESS
/NOBE_CALL_OUT
/CHANNEL_NAME=RTR\$DEFAULT_CHANNEL
/NOCLIENT
/NOCLUSTER
/CONCURRENT
/NOEVENTS
/NOEXPLICIT_START
/FACILITY_NAME=RTR\$DEFAULT_FACILITY
/NOFOREIGN_TM
/HIGH_BOUND=max-value-for-key-type
/See description
/LENGTH_OF_FIELD=4
/LOW_BOUND=lowest value for key-type
/NODE=default-node
/OFFSET_OF_KEY=0
/OUTPUT=stdout
None
/NOPREPARE_EXPLICIT
/NORECEIVE_REPLIES
/RECIPIENT_NAME=null
/RECOVERY
/NOSERVER
/NOSHADOW
/STANDBY
/NOSTRICT_ORDERING
/NOTR_CALL_OUT
/TYPE_OF_FIELD=UNSIGNED

Description

The CALL RTR_OPEN_CHANNEL command causes a command server to call the `rtr_open_channel()` routine using values supplied on the command line.

The numeric status returned from the call is then converted to its textual representation and displayed.

The `rtr_open_channel()` routine itself is described in the C Application Programmer's Reference Manual.

The prototype of `rtr_open_channel()` is:

```

rtr_status_t    rtr_open_channel (
                rtr_channel_t      *pchannel,
                rtr_ope_flag_t     flags,
                rtr_facnam_t       facnam,
                rtr_rcpnam_t       rcpnam,
                rtr_evtnum_t       *pevtnum,
                rtr_access_t       access,
                rtr_numseg_t       numseg,
                rtr_keyseg_t       *pkeyseg
                ) ;

```

Table 9–10 shows the correspondence between values you supply on the command line and the C language parameter values produced and used for the call.

CALL RTR_OPEN_CHANNEL

Table 9–10 Parameters for rtr_open_channel

C Parameter Name	C Parameter Value	RTR CLI Example
channel		/CHANNEL_NAME=name
flags	RTR_NO_FLAGS	none [D]
	RTR_F_OPE_CLIENT	/CLIENT
	RTR_F_OPE_SERVER	/SERVER
	RTR_F_OPE_BE_CALL_OUT	/BE_CALL_OUT
	RTR_F_OPE_NOCONCURRENT	/NOCONCURRENT
	RTR_F_OPE_EXPLICIT_PREPARE	/PREPARE_EXPLICIT
	RTR_F_OPE_EXPLICIT_ACCEPT	/ACCEPT_EXPLICIT
	RTR_F_OPE_EXPLICIT_START	/EXPLICIT_START
	RTR_F_OPE_FOREIGN_TM	/FOREIGN=tm_id
	RTR_F_OPE_NO_RECOVERY	/NORECOVERY
	RTR_F_OPE_RECEIVE_REPLIES	/RECEIVE_REPLIES
	RTR_F_OPE_SHADOW	/SHADOW
	RTR_F_OPE_NOSTANDBY	/NOSTANDBY
	RTR_F_OPE_STRICT_SHD_ORDER	/STRICT_ORDERING
	RTR_F_OPE_TR_CALL_OUT	/TR_CALL_OUT
facnam	"CASHFACIL"	/FACILITY_NAME=CASHFACIL
rcpnam	"CLI6CHAN"	/RECIPIENT_NAME=CLI6CHAN
pevtnum	[All events. See /EVENTS]	/EVENTS=(USER,RTR)
access	J67TF098	/ACCESS=J67TF098
numseg	1	
pkeyseg		
-> ks_type	rtr_keyseg_string	/TYPE_OF_FIELD=STRING
-> ks_length	10	/LENGTH_OF_FIELD=10
-> ks_offset	2	/OFFSET_OF_KEY=2
-> ks_lo_bound	"AAAAAAAAAAAA"	/LOW_BOUND="AAAAAAAAAAAA"
-> ks_hi_bound	"NNNNNNNNNN"	/HIGH_BOUND="NNNNNNNNNN"

Qualifiers

/ACCEPT_EXPLICIT

/NOACCEPT_EXPLICIT

Specifies that the RTR_F_OPE_EXPLICIT_ACCEPT flag is set in the call to `rtr_open_channel()`. This qualifier specifies that the server will accept transactions only by making an explicit call to `rtr_accept_tx`.

/ACCESS=access

/NOACCESS (D)

Specifies an access string (that is, a password). All application programs (clients and servers) must specify the same access string for a given facility.

/BE_CALL_OUT

/NOBE_CALL_OUT (D)

Valid for server channels only. Specifies that the RTR_F_OPE_BE_CALL_OUT flag is set in the flags parameter in the call to `rtr_open_channel()`. The channel is opened as a backend callout server.

/CHANNEL_NAME=channel-name

/CHANNEL_NAME=RTR\$DEFAULT_CHANNEL

Specifies the name of the window's channel for use in subsequent operations on this channel.

`channel_name` is not case sensitive. The default channel name is `RTR$DEFAULT_CHANNEL`.

/CLIENT

/NOCLIENT

Specifies that the RTR_F_OPE_CLIENT flag is set on the call to `rtr_open_channel()`. The channel is opened as a client.

/CLUSTER

/NOCLUSTER (D)

Specifies that the command is executed on all the nodes in the cluster.

If neither `/NODE` nor `/CLUSTER` is specified, the command is executed on the nodes specified by the latest `SET ENVIRONMENT` command. If no `SET ENVIRONMENT` command has been entered, the command is executed only on the node where the command was issued.

CALL RTR_OPEN_CHANNEL

Note

In environments that do not support remote command capability, the /CLUSTER qualifier causes the relevant command to be executed on the local node only.

/CONCURRENT (D)

/NOCONCURRENT

Specifying /NOCONCURRENT sets the RTR_F_OPE_NOCONCURRENT flag in the call to `rtr_open_channel()`, and the server may not be concurrent with other servers. By default, a server may have other concurrent servers.

/EVENTS=event-nr-list

/NOEVENTS (D)

The /EVENTS qualifier specifies that broadcast events are received on the channel. To subscribe to all user and RTR events, enter the qualifier with no arguments. Enter /EVENTS=RTR to receive the full range of RTR events only. Enter /EVENTS=USER to receive the full range of USER events only. Specify particular ranges of event numbers using arguments in the following format:

`/EVENTS=(RTR, n, TO, m, USER, p, TO, q)`

where n, m, p and q are event numbers. The default is to listen to no events.

/EXPLICIT_START

NOEXPLICIT_START (D)

Valid for client channels only. Using this flag requires that an explicit `rtr_start_tx()` be called on this channel. The procedure is in effect until the channel is closed. The EXPLICIT_START flag insures that `rtr_send_to_server()` does not generate new transactions should the `rtr_start_tx()` time out.

If the user calls `rtr_send_to_server()` without first calling `rtr_start_tx()`, the error message RTR_STS_INVIMPCLSTRT is returned informing the caller that they must call `rtr_start_tx()` first on this channel.

/FACILITY_NAME=facility-name

/FACILITY=RTR\$DEFAULT_FACILITY (D)

Specifies the name of the facility for which the channel is declared. An application must specify the facility name when using the RTR CLI. The default facility name is RTR\$DEFAULT_FACILITY.

/FOREIGN_TM[=tm_id]

/NOFOREIGN_TM (D)

Valid for client channels only. This indicates that the global coordinating Transaction Manager (TM) is a Foreign TM (denoted as FTM), and that all transactions on this channel will be coordinated by the FTM. If this qualifier is set, calls to `rtr_start_tx` on this channel must supply a value for the `jointxid` parameter, which is the TXID of the transaction.

A TM identifier can also be passed in as parameter. It must be in the range of 0 to 65535. Default value is 0.

Operators or script programs using nested transactions should specify a TM identifier, particularly if more than one process opens RTR client channels using the same FTM on the one node, or if different types of FTMs are used on the same node. When a process that has open FTM client channels fails, the FTM must be able to find out from RTR what state the transactions are in that were active in that process. Thus the FTM must be able to identify itself to RTR so RTR can find out what transactions were active for that FTM channel. Generally, FTM client channels opened in the same process (and for the same FTM) can have a common TM identifier, but FTM client channels opened in separate processes should have different TM identifiers.

Calling `CALL RTR_OPEN_CHANNEL` with the `FOREIGN_TM` qualifier specified will cause a local journal scan to occur if a journal has not already been opened on that node.

/HIGH_BOUND=high-bound

/HIGH_BOUND=max-val-for-key-type (D)

Specifies the upper bound of the key range that the server handles. The interpretation of `high-bound` depends on the key type. If the key is of type `string`, it is interpreted as text, otherwise it is interpreted as a numeric value. The default for `high-bound` is the largest possible value that can fit in the specified key type.

If the key bound value length is less than the key length (given in `/LENGTH_OF_FIELD`), the key bound will automatically be null-padded to the required length.

/KEYn=keysegdesc

Specifies a partition key segment. Up to eight key segments can be defined for a partition (`KEY1`, `KEY2`,... up to `KEY8`).

CALL RTR_OPEN_CHANNEL

The syntax of the KEYn qualifier is:

```
/KEYn= (type_of_key=[signed|unsigned|string], -  
        length_of_key=nnnn, -  
        offset_of_key=nnnn, -  
        low_bound=low-bound-string, -  
        high_bound=high_bound_string)
```

`type_of_key`= Specifies the field type of the key. The key-type must be either unsigned, signed or string. The default is unsigned.

`length_of_key=nnnn` Specifies the length of the key field in enqueued messages in bytes. Use this qualifier only if the key field type is string, since the key length is in other cases implied by the key type. The default value for key-length is four bytes.

`offset_of_key=nnnn` Specifies the offset of the key within the messages in bytes. The default is zero, that is, the key is at the start of the messages. For discrete key segments such as 35 to 35 or 45 to 45 when the offset points to different parts of a message, RTR does a logical AND of all the segments of the key range and routes only if it finds a match.

In case two or more keys are defined with same offset, RTR routes the message based on the following criteria:

1. Perform logical OR operation on all segments of the key range that have the same offsets.
2. Perform logical AND operation on remaining segments of the key range along with the results obtained from step1.

Note

While defining keys with same offset, the keys should be in a sequence (example: key1, key2 and key3 with same offset is a valid definition, but key1, key2 and key4 with same offset is not a valid definition).

`low_bound`= Specifies the lower bound of the key range that servers in the partition will service. The interpretation of low-bound depends on the key type; if the key is of type string it is interpreted as text, otherwise it is interpreted as a numeric value. The default for low-bound is the smallest possible value that can fit in the specified key type.

If the key bound value length is less than the key length (given in `length_of_key`), the key bound will automatically be null-padded to the required length.

`high_bound=` Specifies the upper bound of the key range that servers in the partition will service. The interpretation of `high-bound` depends on the key type. If the key is of type `string`, it is interpreted as text, otherwise it is interpreted as a numeric value. The default for `high-bound` is the largest possible value that can fit in the specified key type.

If the key bound value length is less than the key length (given in `length_of_key`), the key bound will automatically be null-padded to the required length.

Note

The `/KEYn=keysegdesc` qualifier is an alternative to using the `/xxx_OF_FIELD` qualifier.

`/LENGTH_OF_FIELD=key-field-length`

`/LENGTH_OF_FIELD=4 (D)`

Specifies the length of the key field in the enqueued messages in bytes. Use this qualifier only if the key field type is `string`, since the key length is in all other cases implied by the key type. The default value for `key-length` is four bytes.

`/LOW_BOUND=low-bound`

`/LOW_BOUND=min-val-for-key-type (D)`

Specifies the lower bound of the key range that the server handles. The interpretation of `low-bound` depends on the key type. If the key is of type `string`, it is interpreted as text, otherwise it is interpreted as a numeric value. The default for `low-bound` is the smallest possible value that can fit in the specified key type.

If the key bound value length is less than the key length (given in `/LENGTH_OF_FIELD`), the key bound will automatically be null-padded to the required length.

`/NODE[=node-list]`

`/NODE=default-node (D)`

Specifies that the command is executed on all nodes specified in `node-list`. If `node-list` is omitted, the command is executed only on the node where the command was issued.

CALL RTR_OPEN_CHANNEL

/OFFSET_OF_KEY=offset

/OFFSET_OF_KEY=0 (D)

Specifies the offset of the key within the messages in bytes. The default is zero, that is, the key is at the start of the messages. The qualifier `/KEYn` must be used to specify more than one key segment definition.

/OUTPUT[=filespec]

/OUTPUT=stdout (D)

Specifies that the resulting information is written to the file `filespec`. If `/OUTPUT` or `filespec` is omitted, the standard or default output is used.

/PARTITION_NAME=partition-name

Enables a system manager to specify a particular named partition.

/PREPARE_EXPLICIT

/NOPREPARE_EXPLICIT

Specifies that the flag `RTR_F_OPE_EXPLICIT_PREPARE` is set in the call to `rtr_open_channel()`. This qualifier specifies that the server will receive prepare messages (messages of type `rtr_mt_prepare`).

/RECEIVE_REPLIES

/NORECEIVE_REPLIES (D)

Enables, for a backend callout server, server-to-client messages (replies) to be received. This can be useful in a shadow environment where shadowing servers are expected to reply consistently.

/RECIPIENT_NAME=rcpnam

/RECIPIENT_NAME=null (D)

Specifies an optional name for broadcast reception to be associated with the channel. Only broadcasts matching this name are delivered on the channel. To receive named events, the correct event number must also be specified.

`RECIPIENT_NAME` is case sensitive but defaults to the case-insensitive channel name if not explicitly defined. If `/RECIPIENT_NAME` is supplied without a qualifier value, its value defaults to the value of `/CHANNEL_NAME`. Not supplying the `/RECIPIENT_NAME` qualifier has the same effect as specifying a null string. Wildcard characters *cannot* be used for this qualifier. (However, senders of broadcasts can use wildcards when specifying `/RECIPIENT_SPEC` with the `RTR_BROADCAST_EVENT` call or command).

/RECOVERY (D)

/NORECOVERY

The CLI commands `RTR_OPEN_CHANNEL` accepts the above qualifier. Using `/NORECOVERY` applies the `RTR_F_OPE_NO_RECOVERY` flag to

CALL RTR_OPEN_CHANNEL

the `rtr_open_channel()` API call. The default value of the qualifier is `/RECOVERY`.

/SERVER

/NOSERVER (D)

Specifies that the `RTR_F_OPE_SERVER` flag is set in the call to `rtr_open_channel()`. Use this qualifier to declare the channel as a server.

/SHADOW

/NOSHADOW (D)

Valid for server channels only. The `/SHADOW` qualifier specifies that the `RTR_F_OPE_SHADOW` flag is set in the call to `rtr_open_channel()`. The server is part of a shadow pair.

/STANDBY (D)

/NOSTANDBY

Valid for server channels only. The `/NOSTANDBY` qualifier specifies that the flag `RTR_F_OPE_NOSTANDBY` is set in the call to `rtr_open_channel()`, and the server may not be (or have) standbys. By default, servers may have standbys.

/STRICT_ORDERING

/NOSTRICT_ORDERING (D)

Specifies that the `RTR_F_OPE_STRICT_ORDERING` flag is set in the call to `rtr_open_channel()`. Use this qualifier only in combination with `/SHADOW`.

/TR_CALL_OUT

/NOTR_CALL_OUT (D)

Specifies that the `RTR_F_OPE_TR_CALL_OUT` flag is set in the call to `rtr_open_channel()`, and the server is a router callout server. By default, a server is not a router callout server.

/TYPE_OF_FIELD=key-field-type

/TYPE_OF_FIELD=UNSIGNED (D)

Specifies the field type of the key. The `key-type` must be one of `UNSIGNED`, `SIGNED` or `STRING`. The default is `UNSIGNED`.

Related commands

- `CALL RTR_CLOSE_CHANNEL`

CALL RTR_OPEN_CHANNEL

Examples

This command opens a server channel called RTR\$DEFAULT_CHANNEL that may not have concurrent servers, explicitly accepts transactions and listens for all RTR events.

```
RTR> CALL RTR_OPEN_CHANNEL/SERVER/NOCONCURRENT/ACCEPT_EXPLICIT/EVENTS=RTR
%RTR-S-OK, Normal successful completion
```

This command opens a client channel called FIN1CHAN.

```
RTR> CALL RTR_OPEN_CHANNEL/CLIENT/CHANNEL=FIN1CHAN
%RTR-S-OK, Normal successful completion
```

CALL RTR_RECEIVE_MESSAGE

The **CALL RTR_RECEIVE_MESSAGE** command causes a command server to execute the `rtr_receive_message()` routine and to display the returned status.

Note

This command is not available in the RTR web browser interface.

Format

CALL RTR_RECEIVE_MESSAGE

Command Qualifiers	Defaults
/CHANNEL_NAME=channel-name	/CHANNEL_NAME=RTR\$DEFAULT_CHANNEL
/CLUSTER	/NOCLUSTER
/NODE[=node-list]	/NODE=default-node
/OUTPUT[=filespec]	/OUTPUT=stdout
/TIMEOUT_MS=timeoutms	/TIMEOUT_MS=0
/TYPE=data-being-received	/TYPE=string

Description

The **CALL RTR_RECEIVE_MESSAGE** command causes a command server to call the `rtr_receive_message()` routine using values supplied on the command line. The numeric status returned from the call is then converted to its textual representation and displayed.

The `rtr_receive_message()` routine itself is described in the C Application Programmer's Reference Manual.

The prototype of `rtr_receive_message()` is:

```

rtr_status_t rtr_receive_message (
    rtr_channel_t      *pchannel,
    rtr_rcv_flag_t     flags,
    rtr_channel_t      *prcvchan,
    rtr_msgbuf_t       pmsg,
    rtr_msglen_t       maxlen,
    rtr_timeout_t      timeoutms,
    rtr_msgsb_t        *pmsgsb
) ;

```

CALL RTR_RECEIVE_MESSAGE

Table 9–11 shows the correspondence between values you supply on the command line and the C language parameter values produced and used for the call.

Table 9–11 Parameters for rtr_receive_message

C Parameter Name	C Parameter Value	Command Line Specification
pchannel		[displayed]
flags	RTR_NO_FLAGS	[none] [D]
prcvchan		/CHANNEL=channel_name
pmsg		[message displayed, if any]
maxlen	RTR_MAX_MSGLEN	[reasonable limit for display]
timeoutms		/TIMEOUT_MS=timeoutms
pmsgsb		[relevant fields displayed]
type		/TYPE=data-being-received

For all messages received, RTR displays the contents of the message status block (msgsb) as follows:

- Message type (for example, rtr_mt_opened, rtr_mt_msgn)
- Message length in bytes
- Transaction ID, user handle, and event number are shown if they are relevant for the message type.

For message types that place a status code and reason code in the user buffer, the status code is converted to text and both are shown.

For all other message types, the contents of the user buffer are displayed in hexadecimal and ASCII text.

For certain events (FE, TR, BE GAIN/LOSS), the facility name and nodename of the node that sent the event are displayed.

Qualifiers

/CHANNEL_NAME=channel_name

/CHANNEL_NAME=RTR\$DEFAULT_CHANNEL

Specifies one or more channels from which a message may be received.

To specify two or more channels, enter a comma-separated list, such as

/CHANNEL_NAME=(CHAN1,CHAN2,CHAN5). Channel names may include wildcard characters.

Restriction when using V2 and later RTR Versions in an Application

When using `rtr_receive_message` RTR is careful to only collect messages for the channels it creates, and any V3, V4 or V5 API code active outside of the scope of the V2 API should be careful to do the same. In other words, do not use `RTR_ANYCHAN` in such cases.

Note that `channel_name` is not case sensitive.

Entering the qualifier without a value (that is, `/CHANNEL`) is equivalent to `/CHANNEL=RTR$DEFAULT_CHANNEL`. Omitting the qualifier altogether is equivalent to `/CHANNEL=*` (that is, receive a message on any defined channel).

The command server uses a combination of the channel-name and the window from which the call was issued to uniquely identify which channel to use.

Note that this qualifier sets up the `prcvchan` parameter on the call to `rtr_receive_message`.

/CLUSTER **/NOCLUSTER (D)**

Specifies that the command is executed on all the nodes in the cluster.

If neither `/NODE` nor `/CLUSTER` is specified, the command is executed on the nodes specified by the latest `SET ENVIRONMENT` command. If no `SET ENVIRONMENT` command has been entered, the command is executed only on the node where the command was issued.

Note

In environments that do not support remote command capability, the `/CLUSTER` qualifier causes the relevant command to be executed on the local node only.

/NODE[=node-list] **/NODE=default-node (D)**

Specifies that the command is executed on all nodes specified in `node-list`. If `node-list` is omitted, the command is executed only on the node where the command was issued.

CALL RTR_RECEIVE_MESSAGE

/OUTPUT[=filespec]

/OUTPUT=stdout (D)

Specifies that the resulting information is written to the file filespec. If /OUTPUT or filespec is omitted, the standard or default output is used.

/TIMEOUT_MS=timeoutms

/TIMEOUT_MS=0 (D)

The timeoutms argument defines a timeout for the receive, in milliseconds. If the /TIMEOUT_MS qualifier is not used, the timeout value is infinite (no timeout); if the /TIMEOUT_MS qualifier is used with no value (e.g., /TIMEOUT_MS), the timeout is immediate, equivalent of timeout of 0.

Clock granularity is one second (1000 ms). The call completes after either:

- the specified timeout or when
- a message is available on one of the specified channels

/TYPE=data-being-received

/TYPE=signed, unsigned, string (D)

The type argument specifies the type of data being received (string, unsigned, signed). If no value is given, it defaults to string type.

Examples

The following example shows two CALL RTR_RECEIVE_MESSAGE commands on RTR\$DEFAULT_CHANNEL.

CALL RTR_RECEIVE_MESSAGE

```
RTR> CALL RTR_RECEIVE_MESSAGE /TIMEOUT_MS
%RTR-S-OK, normal successful completion
channel name: RTR$DEFAULT_CHANNEL
msgsb
  msgtype:    rtr_mt_rtr_event
  msglen:     0
  evtnum:     113      (RTR EVTNUM SRRECOVERCMPL)
RTR> CALL RTR_RECEIVE_MESSAGE /TIMEOUT_MS
%RTR-S-OK, normal successful completion
channel name: RTR$DEFAULT_CHANNEL
msgsb
  msgtype:    rtr_mt_msgl
  msglen:     55
  usrhdl:    0
  tid:       1fe5c,495a4,0,0,1bf80,84,36
message
  offset bytes      text
000000 54 68 69 73 20 69 73 20 74 68 65 20 6D 65 73 73 This is the mess
000010 61 67 65 20 74 65 78 74 2E 20 53 6F 6D 65 20 64 age text. Some d
000020 69 67 69 74 73 20 68 65 72 65 3A 20 31 32 33 34 igits here: 1234
000030 35 36 37 38 39 30 00 567890.
```

CALL RTR_REJECT_TX

CALL RTR_REJECT_TX

The **CALL RTR_REJECT_TX** command causes a command server to execute the `rtr_reject_tx()` routine and to display the returned status.

Note

This command is not available in the RTR web browser interface.

Format

```
CALL RTR_REJECT_TX
```

Command Qualifiers	Defaults
/CHANNEL_NAME=channel-name	/CHANNEL_NAME=RTR\$DEFAULT_CHANNEL
/CLUSTER	/NOCLUSTER
/NODE[=node-list]	/NODE=default-node
/OUTPUT[=filespec]	/OUTPUT=stdout
/REASON[=reason]	/REASON=0
/RETRY	/NORETRY

Description

The **CALL RTR_REJECT_TX** command causes a command server to call the `rtr_reject_tx()` routine using values supplied on the command line.

The numeric status returned from the call is then converted to its textual representation and displayed.

The `rtr_reject_tx()` routine itself is described in the C Application Programmer's Reference Manual.

The prototype of `rtr_reject_tx()` is:

```
rtr_status_t  rtr_reject_tx (
                rtr_channel_t  channel,
                rtr_rej_flag_t  flags,
                rtr_reason_t    reason
                ) ;
```

Table 9–12 shows the correspondence between values you supply on the command line and the C language parameter values produced and used for the call.

Table 9–12 Parameters for rtr_reject_tx

C Parameter Name	C Parameter Value	Command Line Specification
channel		/CHANNEL_NAME=name
flags	RTR_NO_FLAGS	[none] [D]
	RTR_F_REJ_RETRY	/RETRY
reason	RTR_NO_REASON	/NOREASON [D]
	reason_value	/REASON=reason_value

Qualifiers

/CHANNEL_NAME=channel_name

/CHANNEL_NAME=RTR\$DEFAULT_CHANNEL

Specifies the channel for which the operation is to be performed.

The command server uses a combination of the channel_name and the window from which the call was issued to uniquely identify which channel to use.

channel_name is not case sensitive.

The default channel name is RTR\$DEFAULT_CHANNEL.

/CLUSTER

/NOCLUSTER (D)

Specifies that the command is executed on all the nodes in the cluster.

If neither /NODE nor /CLUSTER is specified, the command is executed on the nodes specified by the latest SET ENVIRONMENT command. If no SET ENVIRONMENT command has been entered, the command is executed only on the node where the command was issued.

Note

In environments that do not support remote command capability, the /CLUSTER qualifier causes the relevant command to be executed on the local node only.

/NODE[=node-list]

/NODE=default-node (D)

Specifies that the command is executed on all nodes specified in node-list. If node-list is omitted, the command is executed only on the node where the command was issued.

CALL RTR_REJECT_TX

/OUTPUT[=filespec]

/OUTPUT=stdout (D)

Specifies that the resulting information is written to the file filespec. If /OUTPUT or filespec is omitted, the standard or default output is used.

/REASON[=reason]

/REASON=0

Use /REASON to supply a value for the reason parameter in the call to `rtr_reject_tx()`.

The default value for /REASON is 0, which causes the command server to use the value `RTR_NO_REASON` for the reason parameter in the call to `rtr_reject_tx()`.

/RETRY

/NORETRY (D)

Use /RETRY to specify the flags parameter as `RTR_F_REJ_RETRY` in the call to `rtr_reject_tx()`.

The default value for /RETRY is /NORETRY, which causes the command server to use the value `RTR_NO_FLAGS` for the flags parameter in the call to `rtr_reject_tx()`.

Related commands

- `CALL RTR_OPEN_CHANNEL`
- `CALL RTR_ACCEPT_TX`

Examples

Reject the current transaction with a reason of 42.

```
RTR> CALL RTR_REJECT TX /REASON=42
%RTR-S-OK, normal successful completion
```

CALL RTR_REPLY_TO_CLIENT

The **CALL RTR_REPLY_TO_CLIENT** command causes a command server to execute the `rtr_reply_to_client()` routine and to display the returned status. Replies can be compressed with the compression environment variables. See Section 2.13.3 for more details on how to use these variables.

Note

This command is not available in the RTR web browser interface.

Format

```
CALL RTR_REPLY_TO_CLIENT [message-field1] [,message-field2,...]
```

Parameters

[message-field1] [,message-field2...]

Specify the message to be sent as one or more comma-separated parameter values. You can use the `/TYPE_OF_DATA` and `/LENGTH_OF_DATA` positional qualifiers on each parameter value to specify the data type and length of each field.

Command Qualifiers	Defaults
<code>/ACCEPT</code>	<code>/NOACCEPT</code>
<code>/CHANNEL_NAME=channel-name</code>	<code>/CHANNEL_NAME=RTR\$DEFAULT_CHANNEL</code>
<code>/CLUSTER</code>	<code>/NOCLUSTER</code>
<code>/FORMAT[=fmt-string]</code>	<code>/NOFORMAT</code>
<code>/INDEPENDENT</code>	<code>/NOINDEPENDENT</code>
<code>/LENGTH_OF_FIELD=msg length</code>	Depends on data type.
<code>/NODE[=node-list]</code>	<code>/NODE=default-node</code>
<code>/OUTPUT[=filespec]</code>	<code>/OUTPUT=stdout</code>
<code>/TYPE_OF_DATA=data type</code>	<code>/TYPE_OF_DATA=STRING</code>

Description

The **CALL RTR_REPLY_TO_CLIENT** command causes a command server to call the `rtr_reply_to_client()` routine using values supplied on the command line.

The numeric status returned from the call is then converted to its textual representation and displayed.

CALL RTR_REPLY_TO_CLIENT

The `rtr_reply_to_client()` routine itself is described in the C Application Programmer's Reference Manual.

The prototype of `rtr_reply_to_client()` is:

```
rtr_status_t  rtr_reply_to_client (
                rtr_channel_t      channel,
                rtr_rep_flag_t     flags,
                rtr_msgbuf_t       pmsg,
                rtr_msglen_t       msglen,
                rtr_msgfmt_t       msgfmt
                ) ;
```

Table 9–13 shows the correspondence between values you supply on the command line and the C language parameter values produced and used for the call.

Table 9–13 Parameters for `rtr_reply_to_client`

C Parameter Name	C Parameter Value	Command Line Specification
channel		/CHANNEL_NAME=name
flags	RTR_NO_FLAGS	none [D]
	RTR_F_REP_ACCEPT	/ACCEPT
pmsg, msglen, msgfmt ¹		[message definition parameter list with positional qualifiers.]

¹ The actual values used for `pmsg`, `msglen` and `msgfmt` are based upon the message definition you specify as a command line parameter.

The command server uses message data specified as command line parameter values to generate a record containing the message data (for the `pmsg` parameter), the message length (for the `msglen` parameter), and a record type description (for the `msgfmt` parameter).

Qualifiers

/ACCEPT

/NOACCEPT

The `/ACCEPT` qualifier sets the flag `RTR_F_REP_ACCEPT` in the call to `reply_to_client()`. It means the transaction is accepted by this server.

/CHANNEL_NAME=channel_name

/CHANNEL_NAME=RTR\$DEFAULT_CHANNEL

Specifies the channel for which the operation is to be performed.

The command server uses a combination of the channel name and the window from which the call was issued to uniquely identify which channel to use.

channel_name is not case sensitive.

The default channel name is RTR\$DEFAULT_CHANNEL.

/CLUSTER

/NOCLUSTER (D)

Specifies that the command is executed on all the nodes in the cluster.

If neither /NODE nor /CLUSTER is specified, the command is executed on the nodes specified by the latest SET ENVIRONMENT command. If no SET ENVIRONMENT command has been entered, the command is executed only on the node where the command was issued.

Note

In environments that do not support remote command capability, the /CLUSTER qualifier causes the relevant command to be executed on the local node only.

/FORMAT[=fmt-string]

/NOFORMAT (D)

Specifies that a format string should be sent with this message.

If /FORMAT is specified without fmt-string, RTR automatically generates a format string. The format string is generated using the parameters given for the qualifiers /SIGNED, /UNSIGNED, /STRING and /LENGTH. The following table shows permitted values for these qualifiers when using /FORMAT without fmt-string.

Table 9–14 Generated Format Strings

Data Type	With /LENGTH=	With /NOLENGTH
STRING	=n, "%nC"	"%nC" where n=strlen(string)
SIGNED	=1, "%SB"	"%SL"
SIGNED	=2, "%SW"	"%SL"

(continued on next page)

CALL RTR_REPLY_TO_CLIENT

Table 9–14 (Cont.) Generated Format Strings

Data Type	With /LENGTH=	With /NOLENGTH
SIGNED	=4, "%SL"	"%SL"
UNSIGNED	=1, "%UB"	"%SL"
UNSIGNED	=2, "%UW"	"%SL"
UNSIGNED	=4, "%UL"	"%SL"

Refer to the *HP Reliable Transaction Router C Application Programmer's Reference Manual*, section “Defining a Message Format Description” for information on constructing a `fmt-string` parameter.

/INDEPENDENT

/NOINDEPENDENT

Use the `/INDEPENDENT` qualifier to specify the flags parameter `RTR_F_REP_INDEPENDENT` in the call to `rtr_reply_to_client()`.

/LENGTH_OF_FIELD=field-length

Enter the size of the message field that you want to define. The default for string types is the length of the message entered, plus one (for the zero termination byte). The default for signed and unsigned types is four. This is a positional qualifier; it must immediately follow the message field that it refers to.

/NODE[=node-list]

/NODE=default-node (D)

Specifies that the command is executed on all nodes specified in `node-list`. If `node-list` is omitted, the command is executed only on the node where the command was issued.

/OUTPUT[=filespec]

/OUTPUT=stdout (D)

Specifies that the resulting information is written to the file `filespec`. If `/OUTPUT` or `filespec` is omitted, the standard or default output is used.

/TYPE_OF_DATA=STRING | SIGNED | UNSIGNED

/TYPE_OF_DATA=STRING (D)

Enter the data type of the message field that you want to define. The default is the string type. This is a positional qualifier; it must immediately follow the message field that it refers to.

Related commands

- CALL RTR_SEND_TO_SERVER
- CALL RTR_RECEIVE_MESSAGE

Examples

The following example replies a message to the client.

```
RTR> CALL RTR_REPLY_TO_CLIENT "Getting that info for you"  
%RTR-S-OK, Normal successful completion
```

The following example shows a message of type unsigned and entered as a hexadecimal number.

```
RTR> CALL RTR_REPLY_TO_CLIENT "0xFA9BC0"/TYPE_OF_DATA=UNSIGNED  
%RTR-S-OK, Normal successful completion
```

CALL RTR_REQUEST_INFO

CALL RTR_REQUEST_INFO

The **CALL RTR_REQUEST_INFO** command causes a command server to execute the `rtr_request_info()` routine and to display the returned status.

Note

This command is not available in the RTR web browser interface.

Format

CALL RTR_REQUEST_INFO

Command Qualifiers	Defaults
/CHANNEL_NAME=channel-name	/CHANNEL_NAME=RTR\$DEFAULT_CHANNEL
/CLUSTER	/NOCLUSTER
/GETITM=item-name	None
/INFCLA=infoclass	None
/NODE[=node-list]	/NODE=default-node
/OUTPUT[=filespec]	/OUTPUT=stdout
/SELITM=item-name	None
/SELVAL=item-value	None

Description

The **CALL RTR_REQUEST_INFO** command causes a command server to call the `rtr_request_info()` routine using values supplied on the command line.

The `rtr_request_info()` routine itself is described in the C Application Programmer's Reference Manual.

The prototype of `rtr_request_info()` is:

```
    rtr_status_t    rtr_request_info (
    rtr_channel_t   *pchannel,
    rtr_req_flag_t  flags,
    rtr_infoclass_t infcla,
    rtr_itemcode_t selitm,
    rtr_selval_t   selval,
    rtr_itemcode_t getitms
    ) ;
```

Table 9–15 shows the correspondence between values you supply on the command line and the C language parameter values produced and used for the call.

Table 9–15 Parameters for rtr_request_info

C Parameter Name	Parameter Value	Command Line Specification
*pchannel		/CHANNEL_NAME=name
flags	RTR_NO_FLAGS	[none] [D]
infcla	RTR_INFCLA_BACKEND_TX	/INFCLA=BTX
selitm	fdb_f_name	/SELITM=fdb_f_name
selval	CASHFACIL	/SELVAL=CASHFACIL
getitms	fe_node_id	/GETITMS=fe_node_id

Qualifiers

/CHANNEL_NAME=channel_name

/CHANNEL_NAME=RTR\$DEFAULT_CHANNEL

Specifies the channel for which the operation is to be performed.

The command server uses a combination of the channel name and the window from which the call was issued to uniquely identify which channel to use.

channel_name is not case sensitive.

The default channel name is RTR\$DEFAULT_CHANNEL.

/CLUSTER

/NOCLUSTER (D)

Specifies that the command is executed on all the nodes in the cluster.

If neither /NODE nor /CLUSTER is specified, the command is executed on the nodes specified by the latest SET ENVIRONMENT command. If no SET ENVIRONMENT command has been entered, the command is executed only on the node where the command was issued.

Note

In environments that do not support remote command capability, the /CLUSTER qualifier causes the relevant command to be executed on the local node only.

CALL RTR_REQUEST_INFO

/GETITM=item-name[,item-name...]

No default

Specifies the getitm parameter in the rtr_request_info() call.

/INFCLA=infoclass

No default

Specifies the infcla parameter in the rtr_request_info() call.

/NODE[=node-list]

/NODE=default-node (D)

Specifies that the command is executed on all nodes specified in node-list. If node-list is omitted, the command is executed only on the node where the command was issued.

/OUTPUT[=filespec]

/OUTPUT=stdout (D)

Specifies that the resulting information is written to the file filespec. If /OUTPUT or filespec is omitted, the standard or default output is used.

/SELITM=item-name

No default

Specifies the selitm parameter in the rtr_request_info() call.

/SELVAL=item-value

No default

Specifies the selval parameter in the rtr_request_info() call.

Examples

This command requests the backend transaction IDs for the facility CASHFAC.

```
RTR> CALL RTR_REQUEST_INFO/CHANNEL=INFOCHAN  
/INFCLA="btx"/SELITM=fac_id/SELVAL=CASHFAC  
/GETITMS=tb_txdx.tx_id
```

The information can then be viewed by repeatedly executing the following command until the channel is closed.

```
RTR> CALL RTR_RECEIVE_MESSAGE/CHANNEL=INFOCHAN/TIMEOUT
```

CALL RTR_SEND_TO_SERVER

The **CALL RTR_SEND_TO_SERVER** command causes a command server to execute the `rtr_send_to_server()` routine and to display the returned status.

Note

This command is not available in the RTR web browser interface.

Format

```
CALL RTR_SEND_TO_SERVER [message-field1] [,message-field2,...]
```

Parameters

[message-field] [,message-field2,...]

Specify the message to be sent as one or more comma-separated parameter values. You can use the `/TYPE_OF_DATA` and `/LENGTH_OF_DATA` positional qualifiers on each parameter value to specify the data type and length of each field.

Command Qualifiers

```
/ACCEPT
/CHANNEL_NAME=channel-name
/CLUSTER
/EXPENDABLE
/FORMAT[=fmt-string]
/LENGTH_OF_FIELD=msg-length
/NODE[=node-list]
/OUTPUT[=filespec]
/READONLY
/RETURN_TO_SENDER
/TYPE_OF_DATA=data type
```

Defaults

```
/NOACCEPT
/CHANNEL_NAME=RTR$DEFAULT_CHANNEL
/NOCLUSTER
/NOEXPENDABLE
/NOFORMAT
Depends on data type.
/NODE=default-node
/OUTPUT=stdout
/NOREADONLY
/NORETURN_TO_SENDER
/TYPE_OF_DATA=STRING
```

Description

The **CALL RTR_SEND_TO_SERVER** command causes a command server to call the `rtr_send_to_server()` routine using values supplied on the command line.

The numeric status returned from the call is then converted to its textual representation and displayed.

CALL RTR_SEND_TO_SERVER

The `rtr_send_to_server()` routine itself is described in the C Application Programmer's Reference Manual.

The prototype of `rtr_send_to_server()` is:

```
rtr_status_t  rtr_send_to_server (
                rtr_channel_t      channel,
                rtr_sen_flag_t     flags,
                rtr_msgbuf_t       pmsg,
                rtr_msglen_t       msglen,
                rtr_msgfmt_t       msgfmt
                ) ;
```

Table 9–16 shows the correspondence between values you supply on the command line and the C language parameter values produced and used for the call.

Table 9–16 Parameters for `rtr_send_to_server`

C Parameter Name	C Parameter Value	Command Line Specification
channel		/CHANNEL_NAME=name
flags	RTR_NO_FLAGS	none [D]
	RTR_F_SEN_EXPENDABLE	/EXPENDABLE
	RTR_F_SEN_READONLY	/READONLY
	RTR_F_SEN_RETURN_TO_SENDER	/RETURN_TO_SENDER
pmsg, msglen, msgfmt ¹		[message definition parameter list with positional qualifiers]

¹ The actual values used for `pmsg`, `msglen` and `msgfmt` are based upon the message definition you specify as a command line parameter.

The command server uses message data specified as command line parameter values to generate a record containing the message data (for the `pmsg` parameter), the message length (for the `msglen` parameter), and a record type description (for the `msgfmt` parameter).

Qualifiers

/ACCEPT

/NOACCEPT

The **/ACCEPT** qualifier sets the flag `RTR_F_REP_ACCEPT` in the call to `send_to_server()`. It means the transaction is accepted by this client.

/CHANNEL_NAME=channel_name

/CHANNEL_NAME=RTR\$DEFAULT_CHANNEL

Specifies the channel for which the operation is to be performed.

The command server uses a combination of the `channel_name` and the window from which the call was issued to uniquely identify which channel to use.

`channel_name` is not case sensitive.

The default channel name is `RTR$DEFAULT_CHANNEL`.

/CLUSTER

/NOCLUSTER (D)

Specifies that the command is executed on all the nodes in the cluster.

If neither `/NODE` nor `/CLUSTER` is specified, the command is executed on the nodes specified by the latest `SET ENVIRONMENT` command. If no `SET ENVIRONMENT` command has been entered, the command is executed only on the node where the command was issued.

Note

In environments that do not support remote command capability, the `/CLUSTER` qualifier causes the relevant command to be executed on the local node only.

/EXPENDABLE

/NOEXPENDABLE

The `/EXPENDABLE` qualifier sets the flag `RTR_F_SEN_EXPENDABLE` in the call `rtr_send_to_server()`.

/FORMAT[=fmt-string]

/NOFORMAT (D)

Specifies that a format string should be sent with this message.

If `/FORMAT` is specified without `fmt-string`, RTR automatically generates a format string. The format string is generated using the parameters given for the qualifiers `/SIGNED`, `/UNSIGNED`, `/STRING` and `/LENGTH`. The following table shows permitted values for these qualifiers when using `/FORMAT` without `fmt-string`.

CALL RTR_SEND_TO_SERVER

Table 9–17 Generated Format Strings

Data Type	With /LENGTH=	With /NOLENGTH
STRING	=n, "%nC"	"%nC" where n=strlen(string)
SIGNED	=1, "%SB"	"%SL"
SIGNED	=2, "%SW"	"%SL"
SIGNED	=4, "%SL"	"%SL"
UNSIGNED	=1, "%UB"	"%SL"
UNSIGNED	=2, "%UW"	"%SL"
UNSIGNED	=4, "%UL"	"%SL"

Refer to the *HP Reliable Transaction Router C Application Programmer's Reference Manual*, section "Defining a Message Format Description" for information on constructing a `fmt-string` parameter.

/LENGTH_OF_FIELD=field-length

Enter the size of the message field that you want to define. The default for string types is the length of the message entered, plus one (for the zero termination byte). The default for signed and unsigned types is four. This is a positional qualifier; it must immediately follow the message field that it refers to.

/NODE[=node-list]

/NODE=default-node (D)

Specifies that the command is executed on all nodes specified in `node-list`. If `node-list` is omitted, the command is executed only on the node where the command was issued.

/OUTPUT[=filespec]

/OUTPUT=stdout (D)

Specifies that the resulting information is written to the file `filespec`. If `/OUTPUT` or `filespec` is omitted, the standard or default output is used.

/READONLY

/NOREADONLY

The `/READONLY` qualifier sets the flag `RTR_F_SEN_READONLY` in the call `rtr_send_to_server()`. No entry is made in the journal file.

CALL RTR_SEND_TO_SERVER

/RETURN_TO_SENDER

/NORETURN_TO_SENDER

The `/RETURN_TO_SENDER` qualifier sets the flag

`RTR_F_SEN_RETURN_TO_SENDER` in the call `rtr_send_to_server()`.

/TYPE_OF_DATA=STRING | SIGNED | UNSIGNED

/TYPE_OF_DATA=STRING (D)

Enter the data type of the message field that you want to define. The default is the string type. This is a positional qualifier; it must immediately follow the message field that it refers to.

Examples

This command sends a message to a server. The message is type string (the default).

```
RTR> CALL RTR_SEND_TO_SERVER "Get that info for me, please"  
%RTR-S-OK, Normal successful completion
```

CALL RTR_SET_USER_CONTEXT

CALL RTR_SET_USER_CONTEXT

The **CALL RTR_SET_USER_CONTEXT** command causes a command server to execute the `rtr_set_user_context()` routine and to display the returned value.

Format

```
CALL RTR_SET_USER_CONTEXT
```

Command Qualifiers	Defaults
/CHANNEL_NAME=channel-name	/CHANNEL_NAME=RTR\$DEFAULT_CHANNEL
/CONTEXT=value	/CONTEXT=0
/NODE[=node-list]	/NODE=default-node
/OUTPUT[=filespec]	/OUTPUT=stdout

Description

The **CALL RTR_SET_USER_CONTEXT** command causes a command server to call the `rtr_set_user_context()` routine using values supplied on the command line.

The `rtr_set_user_context()` routine itself is described in the *HP Reliable Transaction Router C Application Programmer's Reference Manual*.

The prototype of `rtr_set_user_context()` is:

```
rtr_status_t rtr_set_user_context (
    rtr_channel_t   chan,
    rtr_usrctx_t    usrctx
) ;
```

Table 9–18 shows the correspondence between values you supply on the command line and the C language parameter values produced and used for the call.

Table 9–18 Parameters for `rtr_set_user_context`

C parameter name	C parameter value	command line specification
channel		/CHANNEL_NAME=name
usrctx	457	/CONTEXT=457

Qualifiers

/CHANNEL_NAME=channel_name

/CHANNEL_NAME=RTR\$DEFAULT_CHANNEL

Specifies the channel for which the operation is to be performed.

The command server uses a combination of the channel_name and the window from which the call was issued to uniquely identify which channel to use.

channel_name is not case sensitive.

The default channel name is RTR\$DEFAULT_CHANNEL.

/CONTEXT=value

User context number associated with the current channel. Enter any numeric value.

/NODE[=node-list]

/NODE=default-node (D)

Specifies that the command is executed on all nodes specified in node-list. If node-list is omitted, the command is executed only on the node where the command was issued.

/OUTPUT[=filespec]

/OUTPUT=stdout (D)

Specifies that the resulting information is written to the file filespec. If /OUTPUT or filespec is omitted, the standard or default output is used.

Examples

The following command sets a user context of 567 for RTR\$DEFAULT_CHANNEL.

```
RTR> CALL RTR_SET_USER_CONTEXT /CONTEXT=567
%RTR-S-OK, Normal successful completion
```

CALL RTR_START_TX

CALL RTR_START_TX

The **CALL RTR_START_TX** command causes a command server to execute the `rtr_start_tx()` routine and to display the returned status.

Note

This command is not available in the RTR web browser interface.

Format

CALL RTR_START_TX

Command Qualifiers

/CHANNEL_NAME=channel-name
/CLUSTER
/JOIN_TXID=txid-number
/NODE[=node-list]
/OUTPUT[=filespec]
/TIMEOUT_MS=timeoutms
/TXID_TYPE=txid-type

Defaults

/CHANNEL_NAME=RTR\$DEFAULT_CHANNEL
/NOCLUSTER
/NOJOIN_TXID
/NODE=default-node
/OUTPUT=stdout
/TIMEOUT_MS=0
/TXID_TYPE=RTR

Description

The **CALL RTR_START_TX** command causes a command server to call the `rtr_start_tx()` routine using values supplied on the command line.

The numeric status returned from the call is then converted to its textual representation and displayed.

The `rtr_start_tx()` routine itself is described in the *HP Reliable Transaction Router C Application Programmer's Reference Manual*.

The prototype of `rtr_start_tx()` is:

```
rtr_status_t  rtr_start_tx (
                rtr_channel_t      channel,
                rtr_sta_flag_t     flags,
                rtr_timeout_t      timeoutms,
                rtr_channel_t      joinchan
                ) ;
```

Table 9–19 shows the correspondence between values you supply on the command line and the C language parameter values produced and used for the call.

Table 9–19 Parameters for rtr_start_tx

C Parameter Name	C Parameter Value	Command Line Specification
channel		/CHANNEL_NAME=name
flags	RTR_NO_FLAGS	[none] [D]
timeoutms		/TIMEOUT_MS=timeoutms
joinchan		/JOIN_CHANNEL=channel-name

Qualifiers

/CHANNEL_NAME=channel_name

/CHANNEL_NAME=RTR\$DEFAULT_CHANNEL

Specifies the channel for which the operation is to be performed.

The command server uses a combination of the channel name and the window from which the call was issued to uniquely identify which channel to use.

channel_name is not case sensitive.

The default channel name is RTR\$DEFAULT_CHANNEL.

/CLUSTER

/NOCLUSTER (D)

Specifies that the command is executed on all the nodes in the cluster.

If neither /NODE nor /CLUSTER is specified, the command is executed on the nodes specified by the latest SET ENVIRONMENT command. If no SET ENVIRONMENT command has been entered, the command is executed only on the node where the command was issued.

Note

In environments that do not support remote command capability, the /CLUSTER qualifier causes the relevant command to be executed on the local node only.

CALL RTR_START_TX

/JOIN_TXID=txid-number

/NOJOIN_TXID

The format of the txid-number depends on the TXID_TYPE:

TXID_TYPE	Format of txid-number
RTR	7 integers of 4 bytes each, separated by commas
DDTM	4 integers of 4 bytes each, separated by commas
XA	Character-string up to 128 bytes of length

/NODE[=node-list]

/NODE=default-node (D)

Specifies that the command is executed on all nodes specified in node-list. If node-list is omitted, the command is executed only on the node where the command was issued.

/OUTPUT[=filespec]

/OUTPUT=stdout (D)

Specifies that the resulting information is written to the file filespec. If /OUTPUT or filespec is omitted, the standard or default output is used.

/TIMEOUT_MS=timeoutms

/TIMEOUT_MS=0 (D)

The timeoutms argument defines a timeout for the transaction, in milliseconds. If the /TIMEOUT_MS qualifier is not used, the timeout value is infinite (no timeout); if the /TIMEOUT_MS qualifier is used with no value (e.g., /TIME), the timeout is immediate (time out right away if there is no message to receive).

The granularity of the underlying timer is 1 second. Fractional values of the timeoutms argument are rounded up to the next whole second. A value of 0 causes an immediate timeout.

/TXID_TYPE=txid-type

/TXID_TYPE=RTR (D)

Possible values for TXID_TYPE parameter are RTR, DDTM and XA.

Related commands

- CALL RTR_REJECT_TX
- CALL RTR_ACCEPT_TX

Examples

This command starts a new transaction with a timeout of 5000 milliseconds.

```
RTR> CALL RTR_START_TX /TIMEOUT_MS=5000
%RTR-S-OK, Normal successful completion
```

CLEAR

CLEAR

The **CLEAR** command interactively removes one or more displayed items from a monitor picture.

Format

CLEAR /qualifier

Command Qualifiers	Defaults
/ALL	/NOALL
/X[=column]	Column of previous item
/Y[=row]	Next free row

Description

The **CLEAR** command enables you to interactively remove one or all of the displayed items from a monitor picture. The picture can then be redisplayed using the **MONITOR/RESUME** command. See Chapter 8, RTR Monitoring, for a full discussion of monitor pictures.

Either /ALL, or /X and /Y must be given.

Qualifiers

/ALL

/NOALL (D)

Removes all items from the monitor picture and clears all remembered expressions. This is usually used when starting the interactive definition of a new picture.

/X=column

/Y=row

Specify that the item in position (column,row) is to be removed from the monitor picture. This enables mistakes to be corrected when interactively modifying monitor pictures.

It can also be used to remove unwanted items from predefined monitor pictures.

Related commands

- DISPLAY BAR
- DISPLAY NUMERIC
- DISPLAY TEXT
- MONITOR
- REMEMBER EXPRESSION
- SHOW DISPLAY

Examples

See Section A.1, Interactive Definition of a Monitor Picture, for an example of how to use the CLEAR command.

CREATE CONNECTIONPOOL

CREATE CONNECTIONPOOL

The **CREATE CONNECTIONPOOL** command creates an RTR connection pool that can be used with applications that employ JNDI, the Java Naming and Directory Interface.

Use of this command requires the RTR Java Toolkit.

Format

```
CREATE CONNECTIONPOOL connectionpool_name
```

Command Qualifiers

/CLASSNAME=class_name
/CON_CAPACITYINCREMENT=capacity-increment
/CON_INITIALCAPACITY=initial-capacity
/CON_MAXIMUMCAPACITY=maximum-capacity
/DATABASENAME=database_name
/DESCRIPTION=description
/JNDI_NAME=jndi_name
/NETWORKPROTOCOL=net-protocol
/NODE[=node-list]
/PASSWORD=password
/PORTNUMBER=port-number
/PROPERTY=property_list
/ROLENAME=role-name
/SERVERNAME=server-name
/SERVICEPROVIDER_NAME=ServiceProvider_name
/TEST
/USER=user-name

Defaults

None
None
None
None
None
None
None
None
/NODE=default-node
None
None
None
None
None
None
None
None

Description

The **CREATE CONNECTIONPOOL** command defines an RTR connectionpool for use with JNDI applications.

The command must be issued before any Java application using the connectionpool is started.

See the related commands and the RTR Glossary in the *HP Reliable Transaction Router Getting Started* for additional information on this and other Java-related commands.

Parameters

connectionpool_name

Specifies the name of the connectionpool to be created. A *connectionpool_name* must be unique within an RTR ACP process.

A *connectionpool_name* can contain up to 255 characters. Letters, numbers and underline characters are all valid. The first character of a *connectionpool_name* can be a letter or a number.

If the *connectionpool_name* already exists in the RTR ACP process, the command fails. There is no default value for *connectionpool_name*.

Qualifiers

/CLASSNAME

Specifies the class-name that is used in setting up the connection.

/CON_CAPACITYINCREMENT

Specifies the capacity increment of connectionpool as a standard property to set up the connectionpool object.

/CON_INITIALCAPACITY

Specifies the initial capacity of connectionpool as a standard property to set up the connectionpool object.

/CON_MAXIMUMCAPACITY

Specifies the maximum capacity of connectionpool as a standard property to set up the connectionpool object.

/DATABASENAME

Specifies the database-name as a standard property in setting up the connectionpool object.

/DESCRIPTION

Specifies the description as a standard property in setting up the connectionpool object.

/JNDI_NAME

Specifies the jndi-name used to provide Java applications with JNDI services.

/NETWORKPROTOCOL

Specifies the network protocol as a standard property in setting up the connectionpool object.

CREATE CONNECTIONPOOL

/NODE[=node-list]

/NODE=default-node(D)

Specifies that the command be executed on all nodes in *node-list*. If *node-list* is omitted then the command is executed only on the local node where the command was issued.

/PASSWORD

Specifies the password as a standard property in setting up the connectionpool object.

/PORTNUMBER

Specifies the port number as a standard property in setting up the connectionpool object.

/ROLENAME

Specifies the role-name as a standard property in setting up the connectionpool object.

/PROPERTY

Specifies the standard/non-standard properties and their values in setting up the connectionpool. The format of the property list is as follows: (key1:value1, key2:value2, . . . <NULL>)

For information on JNDI properties, see CREATE SERVICEPROVIDER and the descriptions on the Java web site

<http://java.sun.com/products/jndi/tutorial/beyond/env/overview.html>

RTR supports the following keys:

- APPLET
- AUTHORITATIVE
- BATCHSIZE
- LANGUAGE
- REFERRAL
- SECURITY_AUTHENTICATION
- SECURITY_CREDENTIALS
- SECURITY_PRINCIPAL
- SECURITY_PROTOCOL

CREATE CONNECTIONPOOL

/SERVERNAME

Specifies the server-name as a standard property in setting up the connectionpool object.

/SERVICEPROVIDER_NAME

Specifies a defined serviceprovider that this connectionpool may reference.

/TEST

Test the environment property.

/USER

Specifies the user-name as a standard property in setting up the connectionpool object.

Related Commands

- CREATE DATASOURCE
- CREATE SERVICEPROVIDER
- DELETE CONNECTIONPOOL
- MODIFY CONNECTIONPOOL
- SHOW CONNECTIONPOOL

Examples

The following example shows use of the CREATE CONNECTIONPOOL command to create a connectionpool that references a defined serviceprovider.

```
RTR> CREATE CONNECTIONPOOL koolpool/SERVICEPROVIDER NAME=kooltime-
_RTR>/class=com.ddtek.jdbcx.sequelink.SequeLinkDataSource/jndi=rtrcp-
_RTR>/database=RTRCS/user=sa/password=welcome/port=19996-
_RTR>/server=localhost
%RTR-S-CPCREATED, ConnectionPool koolpool created
```

CREATE DATASOURCE

CREATE DATASOURCE

The **CREATE DATASOURCE** command creates an RTR datasource that can be used with applications written using JNDI, the Java Naming and Directory Interface.

Use of this command requires the RTR Java Toolkit.

Format

```
CREATE DATASOURCE  datasource_name
```

Command Qualifiers

/JNDI_NAME=jndi_name

/NODE[=node-list]

/POOL_NAME=connectionpool_name

/SERVICEPROVIDER_NAME=serviceprovider_name

Defaults

None

/NODE=default-node

None

None

Description

The **CREATE DATASOURCE** command defines an RTR datasource usable with a JNDI application.

The command must be issued before any Java application using the datasource is started.

See the related commands and the RTR Glossary in the *HP Reliable Transaction Router Getting Started* for additional information on this and other Java-related commands.

Parameters

datasource_name

Specifies the name of the datasource to be created. Datasource names must be unique within an RTR ACP process. There is no default value for the *datasource_name*.

If a *datasource_name* already exists in the RTR ACP process, the command fails.

A *datasource_name* can contain up to 255 characters. Letters, numbers and underline characters are all valid. The first character of a *datasource_name* can be a letter or a number.

Qualifiers

/JNDI_NAME

Specifies the jndi-name used to provide Java applications with multiple JNDI services.

/NODE[=node-list]

/NODE=default-node(D)

Executes the command on all the nodes specified in *node-list*. If *node-list* is omitted, then the command is executed only on the node where the command was issued.

/POOL_NAME

Specifies a defined connectionpool that this datasource may reference.

/SERVICEPROVIDER_NAME

Specifies a defined serviceprovider that this datasource may reference.

Related commands

- CREATE CONNECTIONPOOL
- CREATE SERVICEPROVIDER
- DELETE DATASOURCE
- MODIFY DATASOURCE
- SHOW DATASOURCE

Examples

The following example shows use of the CREATE DATASOURCE command to define a datasource that references both a defined connectionpool and a defined serviceprovider.

```
RTR> create datasource myDataSource /jndi=rtrDS -  
RTR> /pool=myconnection /serviceprovider=myservice  
%RTR-S-DSCREATED, datasource myDataSource created
```

CREATE FACILITY

CREATE FACILITY

The **CREATE FACILITY** command creates an RTR facility and prepares it for transaction traffic.

Format

```
CREATE FACILITY [facility_name]
```

Command Qualifiers

```
/ALL_ROLES=node-list  
/BACKEND=backend-list  
/BALANCE  
/CALL_OUT=role-list  
/CLUSTER  
/FRONTEND=frontend-list  
/NODE[=node-list]  
/OUTPUT[=filespec]  
/RESOURCE_MANAGER  
=resource-list  
/ROUTER=router-list
```

Defaults

```
/NOALL_ROLES  
/NOBACKEND  
/NOBALANCE  
/NOCALL_OUT  
/NOCLUSTER  
/NOFRONTEND  
/NODE=default-node  
/OUTPUT=stdout  
None  
/NOROUTER
```

Description

The **CREATE FACILITY** command configures (defines on a node) an RTR facility and readies it for transaction traffic (that is, establishes links to the other participating nodes). Links may be established some time after the command executes.

The command must be issued on all participating nodes before any application programs using the facility are started.

Defining Roles

If the local node has the frontend or backend role, all router nodes must also be defined.

If the local node has the router role, all frontend and backend nodes must also be defined.

If a node has multiple roles, both of the above rules apply.

Do not create a large number of facilities with ad hoc names only for testing purposes. See the discussion in Section 3.6.7.

Using Anonymous Clients

RTR supports use of anonymous clients (clients set up using wildcarded node names), but to ensure correct node recognition, include the explicit node name of a known frontend with the wildcard when defining the configuration with a `CREATE FACILITY` or `EXTEND FACILITY` command. For example, with Node1 a router, and Node2 both frontend and backend, use the following command on the router:

```
CREATE FACILITY test /front=(Node2,*)/router=Node1/backend=Node2
```

This will ensure correct recognition of frontends by the router. The command to use on the frontend/backend would be:

```
CREATE FACILITY text /front=Node2 /router=Node1/backend=Node2
```

Parameters

facility_name

Specifies the name of the facility to be created.

Any application program which uses this facility must specify the same name when it calls `rtr_open_channel()`.

Facility names can contain up to 30 characters. Letters, numbers and underline characters are all valid, but the first character of a facility name must be a letter.

Facility names are not case sensitive.

Foreign Characters Not Supported for RTR Identifiers

The supported character set for RTR identifiers such as facility and partition names is ASCII, with uppercase and lowercase letters being equivalent. Eight-bit characters are not supported because of interoperability requirements.

The default value for `facility_name` is `RTR$DEFAULT_FACILITY`.

The `/ROUTER` qualifier, and at least one of `/FRONTEND` or `/BACKEND` must be specified.

CREATE FACILITY

Qualifiers

/ALL_ROLES=node-list

/NOALL_ROLES (D)

Specifies the names of the nodes that are to act as frontend, router and backend in this facility.

Note that the definition order of nodes may be significant. This applies to the order of router node definitions when frontend load balancing is not enabled. Nodes defined with the `/ROUTER` qualifier have the higher priority and are followed by nodes defined by the `/ALL_ROLES` qualifier. For example, in this definition:

```
$ RTR CREATE FACILITY /ALL_ROLES=mynode /ROUTER=(anode,bnode)
```

The router nodes are in definition order `anode`, `bnode`, `mynode` for all frontends except `mynode`. (Any node that has both frontend and router roles selects its own router first.)

/BACKEND=backend-list

/NOBACKEND (D)

Specifies the names of the nodes that are to act as backends for this facility.

Backend-list is a list of backend-nodes separated by commas. If there is more than one backend-node, backend-list must be enclosed in parentheses.

Backend-node is either the name of a node or `@filespec`, where `filespec` specifies a text file containing a backend-list on each line. Files containing nodelists can include comments. Text following a comment character is ignored. Valid comment characters are `!` and `#`.

/BALANCE

/NOBALANCE (D)

Specifies that load balancing is enabled for the frontend of the transaction router listed with `/ROUTER`. See Section 2.8, Router Load Balancing, for details on load balancing.

It has no significance on a backend node, and is ignored if specified.

The default behavior (`/NOBALANCE`) is for a frontend to connect to the *preferred router*. Preferred routers are selected in the order specified in the `/ROUTER` qualifier of the `CREATE FACILITY` command. This preference is subject to the router being available and quorate. Execute this qualifier on the frontend specifying the routers from which the frontend is to randomly select.

/CALL_OUT[=role-list]

/NOCALL_OUT (D)

Specifies which node roles are to have callout servers running on them.

Role-list is a list of roles separated by commas. If role-list contains more than one role it must be enclosed in parentheses.

Role is one of the keywords ROUTER or BACKEND.

The default for role-list is (ROUTER,BACKEND).

/CLUSTER

/NOCLUSTER (D)

Specifies that the command is executed on all the nodes in the cluster.

If neither /NODE nor /CLUSTER is specified, the command is executed on the nodes specified by the latest SET ENVIRONMENT command. If no SET ENVIRONMENT command has been entered, the command is executed only on the node where the command was issued.

Note

In environments that do not support remote command capability, the /CLUSTER qualifier causes the relevant command to be executed on the local node only.

/FRONTEND=frontend-list

/NOFRONTEND (D)

Specifies the names of the nodes that are to act as frontends for this facility. Frontend-list is a list of frontend-nodes separated by commas. If there is more than one frontend-node, frontend-list must be enclosed in parentheses.

Frontend-node is either the name of a node or @filespec, where filespec specifies a text file containing a frontend-list on each line. Files containing nodelists can include comments. Text following a comment character is ignored. Valid comment characters are “!” and “#”.

/NODE[=node-list]

/NODE=default-node (D)

Specifies that the command is executed on all nodes specified in node-list. If node-list is omitted, the command is executed only on the node where the command was issued.

CREATE FACILITY

/OUTPUT[=filespec]

/OUTPUT=stdout (D)

Specifies that the resulting information is written to the file filespec. If /OUTPUT or filespec is omitted, the standard or default output is used.

/RESOURCE_MANAGER=resource-list

Specifies a list of defined resource managers that this facility may reference. Server applications using this facility and resource manager will receive any recovered transactions when the facility is created. See Appendix C for further information.

/ROUTER=router-list

/NOROUTER (D)

Specifies the names of the nodes that act as routers for this facility.

Router-list is a list of router-nodes separated by commas. If there is more than one router-node, router-list must be enclosed in parentheses.

If /NOBALANCE is specified with the CREATE FACILITY command, the order in which router nodes are specified with the /ROUTER qualifier defines the preferred routing order.

Router-node is either the name of a node or @filespec, where filespec specifies a text file containing a router-list on each line. Files containing nodelists can include comments. Text following a comment character is ignored. Valid comment characters are “!” and “#”.

Related commands

- DELETE FACILITY
- EXTEND FACILITY
- SHOW FACILITY
- TRIM FACILITY

CREATE JOURNAL

The **CREATE JOURNAL** command creates the RTR recovery journal.

Format

```
CREATE JOURNAL [disk-1] ... [disk-n]
```

Command Qualifiers	Defaults
/BLOCKS=nr-blocks	/BLOCKS=1000
/CLUSTER	/NOCLUSTER
/MAXIMUM_BLOCKS=nr-blocks	/MAXIMUM_BLOCKS=1000
/NODE[=node-list]	/NODE=default-node
/OUTPUT[=filespec]	/OUTPUT=stdout
/SUPERSEDE	/NOSUPERSEDE

Description

The **CREATE JOURNAL** command creates RTR's recovery journal files on the specified disks. The target or minimum size of the files is specified using the **/BLOCKS** qualifier (512-byte blocks). The RTR journaling system extends the journal up to **/MAXIMUM_BLOCKS** as needed, or trims the journal to **/BLOCKS** to keep the journal file to this size. Specifying large block values can cause the command to take a long time to complete.

The **/MAXIMUM_BLOCKS** qualifier specifies the maximum size that the journal file can extend to; the RTR journaling system will not extend the journal file beyond this size. If the journal file grows to the maximum size specified, RTR processing stops because transactions cannot be safeguarded if they cannot be written to the journal file.

/BLOCKS and **/MAXIMUM_BLOCKS** are positional qualifiers, so the journal files need not have the same size on each disk.

The **CREATE JOURNAL** command checks that a journal does not already exist for the node. An error occurs if a journal does exist, unless the **/SUPERSEDE** qualifier is specified.

When the **/SUPERSEDE** qualifier is specified, any previously existing journal files are deleted. For this reason the **CREATE JOURNAL/SUPERSEDE** command should not be issued on a node being started up after a failure if the transactions interrupted by the failure need to be recovered. The **CREATE JOURNAL** command is often entered automatically from a startup command procedure.

CREATE JOURNAL

RTR only uses journal files on nodes that are configured to run servers, that is, on backends and on routers with callout servers.

Parameters

disk-1, ... disk-n

Specifies a list of disk names where the new journal is to reside.

If no disks are specified, the issuer's current default disk is used.

Spreading the journal over more than one physical disk can improve performance if I/O to the journal file becomes a bottleneck.

Table 9–20 Platform-Specific Information

Platform	Journal Root	Finding Disks	Notes
UNIX	/rtrjnl	Use df	Enter disk names as they appear in /dev. Enclose disk names in quotes and separate names with commas. The journals reside in subdirectories of the /rtrjnl.
OpenVMS	[RTRJNL]	Use SHOW DEVICE.	If the SYSTEM account has insufficient disk quota for journal file creation, you must have the EXQUOTA privilege for the command to complete successfully.
Windows	rtrjnl	Use the Desktop.	On shared SCSI disks in a Microsoft Cluster Server Environment, the cluster nodenames and disk names must be all uppercase, for example, //CLUSTERNAME/DISKNAME.

Qualifiers

/BLOCKS[=nr-blocks]

/BLOCKS=1000 (D)

Specifies the target size of the journal file in 512-byte blocks. This qualifier can be applied locally to each disk or globally for all disks. The maximum number of blocks that can be specified is 524287 blocks on a single disk.

/MAXIMUM_BLOCKS[=nr-blocks]

/MAXIMUM_BLOCKS=1000 (D)

Specifies the maximum size that the journal file can use, up to 524287 blocks on each disk. This qualifier can be applied locally to each disk or globally for all disks.

/CLUSTER

/NOCLUSTER (D)

Specifies that the command is executed on all the nodes in the cluster.

If neither **/NODE** nor **/CLUSTER** is specified, the command is executed on the nodes specified by the latest **SET ENVIRONMENT** command. If no **SET ENVIRONMENT** command has been entered, the command is executed only on the node where the command was issued.

Note

In environments that do not support remote command capability, the **/CLUSTER** qualifier causes the relevant command to be executed on the local node only.

/NODE[=node-list]

/NODE=default-node (D)

Specifies that the command is executed on all nodes specified in *node-list*. If *node-list* is omitted, the command is executed only on the node where the command was issued.

/OUTPUT[=filespec]

/OUTPUT=stdout (D)

Specifies that the resulting information is written to the file *filespec*. If **/OUTPUT** or *filespec* is omitted, the standard or default output is used.

/SUPERSEDE

/NOSUPERSEDE (D)

Specifies how to handle the case where a journal already exists.

If **/SUPERSEDE** is specified, a journal is created whether or not a journal previously existed (unless the previously existing journal is currently in use). The previous contents of the journal, if any, are destroyed.

If **/NOSUPERSEDE** is specified (default), a journal is created only if no journal previously existed.

CREATE JOURNAL

Related commands

- DELETE JOURNAL
- MODIFY JOURNAL
- SHOW JOURNAL

Examples

```
RTR> CREATE JOURNAL /SUPERSEDE DISK1$:/BLOCK=1000/MAXIMUM_BLOCK=10000, -  
_RTR> DISK2$:/BLOCK=2000/MAXIMUM_BLOCK=200000
```

This command deletes any existing journal files and then creates new ones on DISK1\$ and DISK2\$. The target sizes of the journal files are 1000 and 2000 blocks, and the maximum sizes are 10,000 and 200,000 blocks respectively.

```
RTR> CREATE JOURNAL "/dev/rz3a", "/dev/rz2c" /BLOCK=1000 /MAXIMUM_BLOCK=2000
```

This command creates journal files on /dev/rz3a and /dev/rz2c. The target sizes of the journal files is 1000 blocks and the maximum size of the journal on /dev/rz2c is 2000 blocks.

CREATE PARTITION

The **CREATE PARTITION** command creates an RTR partition.

Format

```
CREATE PARTITION [partition_name]
```

Command Qualifiers

```
/CLUSTER
/CONCURRENT
/FACILITY=facility-name
/KEYn=keysegdesc
/NODE[=node-list]
/OUTPUT[=filespec]
/RECOVERY
/RESOURCE_MANAGER=rmname
/SHADOW
/STANDBY
/STRICT_ORDERING
```

Defaults

```
/NOCLUSTER
/NOCONCURRENT
/FACILITY=RTR$DEFAULT_FACILITY
See description
/NODE=default-node
/OUTPUT=stdout
/NORECOVERY
None
/NOSHADOW
/STANDBY
/NOSTRICT_ORDERING
```

Description

The **CREATE PARTITION** command defines an RTR partition. The partition characteristics that may be defined include key range or ranges and whether attached server processes can be shadows or standbys.

The command must be issued before any server application programs using the partition are started.

Parameters

partition_name

Specifies the name of the partition to be created. Partition names must be unique within a facility.

Any application program which uses this partition must specify the same name when it calls `rtr_open_channel()`.

Partition names can contain up to 63 characters. Letters, numbers and underline characters are all valid. The first character of a partition name can be a letter or a number. If a partition name already exists in the facility, the command fails.

The default value for `partition_name` is `RTR$DEFAULT_PARTITION`.

CREATE PARTITION

It is possible but not recommended to give a different partition name to the same partition on each backend. With different partition names, RTR Explorer will display a string representation of the key range instead of one of the names.

Qualifiers

/CLUSTER

/NOCLUSTER (D)

Specifies that the command is executed on all the nodes in the cluster.

If neither `/NODE` nor `/CLUSTER` is specified, the command is executed on the nodes specified by the latest `SET ENVIRONMENT` command. If no `SET ENVIRONMENT` command has been entered, the command is executed only on the node where the command was issued.

Note

In environments that do not support remote command capability, the `/CLUSTER` qualifier causes the relevant command to be executed on the local node only.

/CONCURRENT (D)

/NOCONCURRENT

Specifies that concurrent servers are allowed for this partition.

/FACILITY

Specifies the name of the facility in which the partition is being created.

/KEYn=keysegdesc

Specifies a partition key segment. Up to 9 key segments may be defined for a partition (`KEY1`, `KEY2`,... up to `KEY9`). If more than 9 key segments are required, a named partition can be created using the `rtr_open_channel()` call.

The syntax of the `KEYn` qualifier is:

```
/KEYn= (type_of_key=[signed|unsigned|string], -
        length_of_key=nnnn, -
        offset_of_key=nnnn, -
        low_bound=[string|nnnn] -
        high_bound=[string|nnnn])
```

`type_of_key=` Specifies the field type of the key. The key-type must be one of `unsigned`, `signed` or `string`. The default is `unsigned`.

`length_of_key=nnnn` Specifies the length of the key field in enqueued messages in bytes. For signed or unsigned ints, length may be either 1, 2, 4 or 8 bytes. The default value for `key-length` is 4 bytes.

`offset_of_key=nnnn` specifies the offset of the key within the messages in bytes. The default is zero, that is, the key is at the start of the messages. For discrete key segments such as 35 to 35 or 45 to 45 when the offset points to different parts of a message, RTR does a logical AND of all the segments of the key range and routes only if it finds a match.

In case two or more keys are defined with same offset, RTR routes the message based on the following criteria:

1. Perform logical OR operation on all segments of the key range that have the same offsets.
2. Perform logical AND operation on remaining segments of the key range along with the results obtained from Step1.

Note

While defining keys with same offset, the keys should be in a sequence (example: `key1`, `key2` and `key3` with same offset is a valid definition, but `key1`, `key2` and `key4` with same offset is not a valid definition)

`low_bound=` Specifies the lower bound of the key range that servers in the partition will service. The interpretation of `low-bound` depends on the key type; if the key is of type string, it is interpreted as text, otherwise it is interpreted as a numeric value. The default for `low-bound` is the smallest possible value that can fit in the specified key type.

If the key bound value length is less than the key length (given in `length_of_key`), the key bound will automatically be null-padded to the required length.

`high_bound=` Specifies the upper bound of the key range that servers in the partition will service. The interpretation of `high-bound` depends on the key type. If the key is of type string, it is interpreted as text, otherwise it is interpreted as a numeric value. The default for `high-bound` is the largest possible value that can fit in the specified key type.

If the key bound value length is less than the key length (given in `length_of_key`), the key bound will automatically be null-padded to the required length.

CREATE PARTITION

If the specified key range overlaps that of an existing partition in the facility, or if the key segment description conflicts with an existing definition, the command fails.

/NODE[=node-list]

/NODE=default-node (D)

Specifies that the command is executed on all nodes specified in `node-list`. If `node-list` is omitted, the command is executed only on the node where the command was issued.

/OUTPUT[=filespec]

/OUTPUT=stdout (D)

Specifies that the resulting information is written to the file `filespec`. If `/OUTPUT` or `filespec` is omitted, the standard or default output is used.

/RECOVERY (D)

NORECOVERY

Using `/NORECOVERY` applies the `RTR_F_OPE_NO_RECOVERY` flag to the `rtr_open_channel()` API call. The default value of the qualifier is `/RECOVERY`.

Valid for a server channel, this flag specifies partition operation without the services of the RTR recovery journal. This option may be useful for applications whose focus is on the timely delivery of messages with limited lifetimes, where the recovery of possibly stale data is not of interest. Since no IO operations to the RTR journal are performed, resource consumption per transaction will be lower, particularly for applications where the number of concurrently active servers is small.

Partitions operating in this mode will perform the usual recovery operations, but no recovery transactions will be found. Further, shadowed partitions in remember mode using this option are also not using the journal, so shadow recovery of such partitions will find no shadow recovery transactions. Since consistency between shadowed sites can thus no longer be maintained, server channels attached to such partitions will automatically be closed should such a non-journalled partition transition from an active to an inactive state.

/RESOURCE_MANAGER

Specifies that the partition will be managed by an underlying resource manager, `rmname`, via the XA protocol.

When you specify the XA-managed attribute for a partition at the command line, the attribute remains until the partition goes away. A partition can be managed by only one resource manager. When creating a new partition, do not use an existing resource manager name unless the partition previously using the resource manager name has been deleted.

/SHADOW

/NOSHADOW (D)

Specifies that shadow servers are allowed for this partition.

/STANDBY (D)

/NOSTANDBY

Specifies that standby servers are allowed for this partition.

/STRICT_ORDERING

/NOSTRICT_ORDERING (D)

Ordinarily RTR determines groups of independently voting concurrent transactions on the primary site from server behaviour. Transactions within a group can then be presented on the secondary in any order. This flag modifies this behaviour so that transactions are presented on the secondary site strictly in the order in which they are accepted by the application on the primary.

CREATE PARTITION

Usage Restriction

For consistent operation, the shadow order flag depends on the journal-less flag. That is, only certain combinations are allowed:

This Shadow Order Flag Setting	With this No_ Recovery Flag Setting	Is:
STRICT_SHD_ORDER	NO_RECOVERY	
0	0	Allowed
0	1	Allowed
1	1	Allowed
1	0	Not allowed

For further information on transaction grouping, please refer to the *HP Reliable Transaction Router Application Design Guide*. This flag is only valid for server channels that also specify shadowing. All partition instances should agree on the setting of this flag. Failure to do so will result in a channel-open error.

Related commands

- CREATE FACILITY
- SET PARTITION

Examples

```
RTR> CREATE PARTITION myPartition/facility=myFacility/-  
_RTR> Key1=(length=1, type=signed,low=1,high=1)/NOSTANDBY  
%RTR-I-PRTCREATE, partition created
```

```
RTR> CREATE PARTITION ab/facility=ABC/NOSTANDBY/key1=(type=string,-  
_RTR> length=2,offset=0,low="AB",high="CD")  
%RTR-I-PRTCREATE, partition created
```

CREATE SERVICEPROVIDER

The **CREATE SERVICEPROVIDER** command creates an RTR service-provider that can be used with applications written using JNDI, the Java Naming and Directory Interface.

Use of this command requires the RTR Java Toolkit.

Format

```
CREATE SERVICEPROVIDER serviceprovider_name
```

Command Qualifiers	Defaults
/DNS_URL=dns_url-name	None
/INITIAL_CONTEXT_FACTORY=initial_context_factory-name	None
/NODE[=node-list]	/NODE=default-node
/OBJECT_FACTORIES=object_factories-name	None
/PROPERTY=property_list	None
/PROVIDER_URL=provider_url-name	None
/TEST	None
/URL_PKG_PREFIXES=url_pkg_prefixes-name	None

Description

The **CREATE SERVICEPROVIDER** command defines an RTR serviceprovider usable with a JNDI application.

The command must be issued before any Java application using the serviceprovider is started.

See the related commands and the RTR Glossary in the *HP Reliable Transaction Router Getting Started* for additional information on this and other Java-related commands.

Parameters

serviceprovider_name

Specifies the name of the serviceprovider to be created. Serviceprovider names must be unique within an RTR ACP process.

If the *serviceprovider_name* already exists in the RTR ACP process, the command fails. There is no default value for *serviceprovider_name*.

A *serviceprovider_name* can contain up to 255 characters. Letters, numbers and underline characters are all valid. The first character of a *serviceprovider_name* can be a letter or a number.

CREATE SERVICEPROVIDER

Qualifiers

/DNS_URL

Specifies a constant containing the name of the environment property giving the DNS host and domain names to use for the JNDI URL context (for example, "dns://somehost/wiz.com").

/INITIAL_CONTEXT_FACTORY

Specifies a constant containing the class name of the environment property that specifies the initial context factory.

/NODE[=node-list]

/NODE=default-node(D)

Execute the command on all nodes specified in *node-list*. If *node-list* is omitted, then the command is executed only on the local node where the command was issued.

/OBJECT_FACTORIES

Specifies a constant containing the name of the environment property that specifies the colon-separated list of object-factory class names.

/PROPERTY

Specifies keys and values for the remaining environment property names. The format of the property list is (key1:value1,key2:value2, . . . <NULL>).

RTR supports the following keys:

- APPLET
- AUTHORITATIVE
- BATCHSIZE
- LANGUAGE
- REFERRAL
- SECURITY_AUTHENTICATION
- SECURITY_CREDENTIALS
- SECURITY_PRINCIPAL
- SECURITY_PROTOCOL

For information on these JNDI environment properties, see the descriptions on the Java web site

<http://java.sun.com/products/jndi/tutorial/beyond/env/overview.html>

/PROVIDER_URL

Specifies a constant containing the name of the environment property that specifies a URL string for configuring the service provider specified by the INITIAL_CONTEXT_FACTORY property.

/TEST

Test the environment property.

/URL_PKG_PREFIXES

Specifies a constant containing the name of the environment property that specifies the colon-separated list of package prefixes to use when loading URL-context factories.

Related commands

- DELETE SERVICEPROVIDER
- MODIFY SERVICEPROVIDER
- SHOW SERVICEPROVIDER

Examples

The following example shows use of the CREATE SERVICEPROVIDER command. The command sets initial context for the serviceprovider.

```
RTR> create serviceprovider myservice -  
  RTR> /INITIAL=com.sun.jndi.fscontext.RefFSContextFactory  
%RTR-S-SPCREATED, ServiceProvider myservice created
```

DEFINE /KEY

DEFINE /KEY

The **DEFINE /KEY** command assigns a string to a keyboard function key.

Note

This command is not available in the RTR web browser interface.

Format

```
DEFINE /KEY key-name "equivalence-string"
```

Command Qualifiers

```
/[NO]ECHO  
/IF_STATE  
/LOCK_STATE  
/LOG  
/SET_STATE=state-name  
/TERMINATE
```

Defaults

```
/ECHO  
/NOIF_STATE  
/NOLOCK_STATE  
/NOLOG  
/NOSET_STATE  
/NOTERMINATE
```

Description

This command lets you assign a string to a function key, possibly overriding any predefined function that was bound to that key. When you then press the key, the RTR Utility enters the currently associated string into your command line. The RTR **DEFINE /KEY** command is similar to the OpenVMS DCL **DEFINE /KEY** command.

A key definition remains in effect until you redefine the key or exit from the RTR Utility. You can include key definitions in command procedures, for example in the RTR Utility initialization file.

The **/IF_STATE** qualifier lets you increase the number of key definitions available on your terminal. The same key can be assigned any number as long as each definition is associated with a different state.

By default, the current key state is the **DEFAULT** state. The current state can be changed by pressing a key that causes a state change (that is, a key that was defined with the **DEFINE /KEY /STATE** command).

Parameters

key-name

Specifies a function key to be assigned a string. Table 9–21 describes the valid key names.

Table 9–21 Key Names

Key-name	LK201	VT100-type
PF1	PF1	PF1
PF2	PF2	PF2
PF3	PF3	PF3
PF4	PF4	PF4
KP0, KP1 ..KP9	Keypad 0 .. 9	Keypad 0 .. 9
PERIOD	Keypad period (.)	Keypad period (.)
COMMA	Keypad comma (,)	Keypad comma (,)
MINUS	Keypad minus (-)	Keypad minus (-)
ENTER	ENTER	ENTER
E1	Find	
E2	Insert Here	
E3	Remove	
E4	Select	
E5	Prev Screen	
E6	Next Screen	
HELP	Help	
DO	Do	
F6, F7, .. F20	F6, F7, .. F20	

equivalence-string

Specifies the string to be processed when the specified key is pressed. Typically, this is all or part of an RTR command.

If the string contains spaces or non-alphanumeric characters, it must be enclosed in quotation marks.

DEFINE /KEY

Qualifiers

/ECHO (D)

/NOECHO

Controls whether the command line is displayed after the key has been pressed. Do not use /ECHO with /NOTERMINATE.

/IF_STATE=state-name

/NOIF_STATE (D)

Specifies the name of a state to which a key definition applies. /IF_STATE assigns the key definitions to the specified states. A state name can be any appropriate alphanumeric string. /NOIF_STATE (the default) assigns the key definition to the DEFAULT state.

/LOCK_STATE

/NOLOCK_STATE (D)

Controls how long the state set by /SET_STATE remains in effect after the specified key is pressed. /LOCK_STATE causes the state to remain in effect until it is changed explicitly by another function key being pressed that has the /SET_STATE attribute. /NOLOCK_STATE (the default) causes the state to remain in effect only until the next terminator character is typed, or until the next define function key is pressed.

/LOG

/NOLOG (D)

Controls whether a message is displayed indicating that the key definition has been successfully created.

/SET_STATE=state-name

/NOSETSTATE (D)

Controls whether pressing the key changes the current key state. /SET_STATE changes the current state to state-name when you press the key. /NOSET_STATE (the default) causes the current state to remain in effect.

/TERMINATE

/NOTERMINATE (D)

Controls whether the specified string is to be terminated (processed) when the key is pressed. /TERMINATE causes the string to be terminated when the key is pressed. /NOTERMINATE (the default) allows you to press other keys before terminating the string by pressing the `RETURN` key.

Related commands

- SHOW KEY

Examples

1.

```
RTR> DEFINE /KEY PF3 "SHOW RTR" /TERMINATE
DEFAULT PF3 key has been defined as "SHOW RTR"
RTR> PF3
```

RTR running on node BE1

The DEFINE /KEY command defines the PF3 key on the keypad to perform a SHOW RTR command. DEFAULT refers to the default state.

2.

```
RTR> DEFINE /KEY PF1 "HELP " /SET_STATE=GOLD /NOTERMINATE /ECHO
DEFAULT PF1 key has been defined as "HELP "
RTR> DEFINE /KEY PF1 " CREATE" /TERMINATE /IF_STATE=GOLD /ECHO
GOLD PF1 key has been defined as "CREATE"
RTR> PF1
RTR> HELP PF1
RTR> HELP CREATE
The "CREATE FACILITY" command is used to ...
```

The first DEFINE /KEY command defines the PF1 key to be the string HELP. The state is set to GOLD for the subsequent key. The /NOTERMINATE qualifier instructs the system to remain in command input mode when the key is pressed. The second DEFINE /KEY command defines the use of the PF1 key when the keypad is in the GOLD state. When the keypad is in the GOLD state, pressing PF1 will cause the current read to be terminated.

If you press PF1 twice, the system displays and processes the HELP CREATE command.

The word DEFAULT in the second line of the example refers to the fact that PF1 has been defined in the default state. Note the space before the word CREATE in the second DEFINE /KEY command. If the space is omitted, the system fails to recognize CREATE as the keyword for the HELP command.

DELETE CONNECTIONPOOL

DELETE CONNECTIONPOOL

The **DELETE CONNECTIONPOOL** command deletes an existing RTR connectionpool.

Use of this command requires the RTR Java Toolkit.

Format

```
DELETE CONNECTIONPOOL connectionpool_name
```

Command Qualifiers

```
/NODE[=node-list]
```

Defaults

```
/NODE=default-node
```

Description

The **DELETE CONNECTIONPOOL** command deletes the specified connectionpool. The **DELETE CONNECTIONPOOL** command fails if the connectionpool does not exist, or if the connectionpool has been created but is currently in use. To delete a connectionpool instance, you must delete all datasources that reference it. There is no default value for *connectionpool_name*.

See the related commands and the RTR Glossary in the *HP Reliable Transaction Router Getting Started* for additional information on this and other Java-related commands.

Parameters

connectionpool_name

The name of the connectionpool to delete.

The parameter *connectionpool_name* is required.

Qualifiers

/NODE[=node-list]

/NODE=default-node(D)

Execute the command on all nodes in *node-list*. If *node-list* is omitted, the command is executed only on the local node where the command was issued.

Related Commands

- CREATE CONNECTIONPOOL
- CREATE DATASOURCE
- CREATE SERVICEPROVIDER
- MODIFY CONNECTIONPOOL
- SHOW CONNECTIONPOOL

Examples

The following example shows use of the DELETE CONNECTIONPOOL command to delete the connectionpool called myconnection.

```
RTR> delete connect myconnection
%RTR-S-CPDELETED, ConnectionPool myconnection deleted
```

DELETE DATASOURCE

DELETE DATASOURCE

The **DELETE DATASOURCE** command deletes an existing RTR datasource. Use of this command requires the RTR Java Toolkit.

Format

```
DELETE DATASOURCE  datasource_name
```

Command Qualifiers

```
/NODE[=node-list]
```

Defaults

```
/NODE=default-node
```

Description

The **DELETE DATASOURCE** command deletes the specified datasource. The **DELETE DATASOURCE** command fails if the datasource does not exist. There is no default value for *datasource_name*.

See the related commands and the RTR Glossary in the *HP Reliable Transaction Router Getting Started* for additional information on this and other Java-related commands.

Parameters

datasource_name

The name of the datasource to delete.

The parameter `datasource_name` must be supplied.

Qualifiers

/NODE[=node-list]

/NODE=default-node(D)

Executes the command on all nodes in *node-list*. If *node-list* is omitted, the command is executed only on the local node where the command was issued.

Related Commands

- CREATE CONNECTIONPOOL
- CREATE DATASOURCE
- CREATE SERVICEPROVIDER
- MODIFY DATASOURCE

- SHOW DATASOURCE

Examples

The following example shows use of the DELETE DATASOURCE command to delete the datasource called mydatasource.

```
RTR> DELETE DATASOURCE mydatasource
%RTR-S-DSDELETED, datasource mydatasource deleted
```

DELETE FACILITY

DELETE FACILITY

The **DELETE FACILITY** command deletes an RTR facility.

Format

```
DELETE FACILITY facility_name
```

Command Qualifiers

/CLUSTER

/NODE[=node-list]

/OUTPUT[=filespec]

Defaults

/NOCLUSTER

/NODE=default-node

/OUTPUT=stdout

Description

The **DELETE FACILITY** command removes the specified facility on the node where the command is issued. After issuing this command, applications are no longer able to use the facility. Any outstanding transactions using the facility are aborted.

Parameters

facility_name

The name of the facility to delete.

The parameter `facility_name` must be supplied.

Qualifiers

/CLUSTER

/NOCLUSTER (D)

Specifies that the command is executed on all the nodes in the cluster.

If neither `/NODE` nor `/CLUSTER` is specified, the command is executed on the nodes specified by the latest `SET ENVIRONMENT` command. If no `SET ENVIRONMENT` command has been entered, the command is executed only on the node where the command was issued.

Note

In environments that do not support remote command capability, the `/CLUSTER` qualifier causes the relevant command to be executed on the local node only.

/NODE[=node-list]

/NODE=default-node (D)

Specifies that the command is executed on all nodes specified in `node-list`. If `node-list` is omitted, the command is executed only on the node where the command was issued.

/OUTPUT[=filespec]

/OUTPUT=stdout (D)

Specifies that the resulting information is written to the file `filespec`. If `/OUTPUT` or `filespec` is omitted, the standard or default output is used.

Related commands

- CREATE FACILITY
- SHOW FACILITY

Examples

See Chapter 2, Starting and Setting Up RTR, for examples of how to use the DELETE FACILITY command.

DELETE JOURNAL

DELETE JOURNAL

The **DELETE JOURNAL** command deletes an RTR journal.

Format

DELETE JOURNAL

Command Qualifiers

/CLUSTER

/NODE[=node-list]

/OUTPUT[=filespec]

Defaults

/NOCLUSTER

/NODE=default-node

/OUTPUT=stdout

Description

The **DELETE JOURNAL** command deletes a previously created RTR journal on the node where the command is issued.

The **DELETE JOURNAL** command will fail if a journal does not exist, or if a journal has been created but is currently in use. The command causes the previous contents of the journal, if any, to be destroyed.

Qualifiers

/CLUSTER

/NOCLUSTER (D)

Specifies that the command is executed on all the nodes in the cluster.

If neither **/NODE** nor **/CLUSTER** is specified, the command is executed on the nodes specified by the latest **SET ENVIRONMENT** command. If no **SET ENVIRONMENT** command has been entered, the command is executed only on the node where the command was issued.

Note

In environments that do not support remote command capability, the **/CLUSTER** qualifier causes the relevant command to be executed on the local node only.

/NODE[=node-list]

/NODE=default-node (D)

Specifies that the command is executed on all nodes specified in `node-list`. If `node-list` is omitted, the command is executed only on the node where the command was issued.

/OUTPUT[=filespec]

/OUTPUT=stdout (D)

Specifies that the resulting information is written to the file `filespec`. If `/OUTPUT` or `filespec` is omitted, the standard or default output is used.

Related commands

- CREATE JOURNAL
- MODIFY JOURNAL
- SHOW JOURNAL

DELETE PARTITION

DELETE PARTITION

The **DELETE PARTITION** command deletes an RTR PARTITION.

Format

```
DELETE PARTITION partition_name
```

Command Qualifiers

/CLUSTER

/NODE[=node-list]

/OUTPUT[=filespec]

/FACILITY=facility-name

Defaults

/NOCLUSTER

/NODE=default-node

/OUTPUT=stdout

None

Description

The **DELETE PARTITION** command removes the specified partition on the node where the command is issued.

Parameters

PARTITION_name

The name of the partition to delete.

The parameter `partition_name` must be supplied. It may be specified as `partition_name` or as `facility_name:partition_name`.

Qualifiers

/CLUSTER

/NOCLUSTER (D)

Specifies that the command is executed on all the nodes in the cluster.

If neither `/NODE` nor `/CLUSTER` is specified, the command is executed on the nodes specified by the latest `SET ENVIRONMENT` command. If no `SET ENVIRONMENT` command has been entered, the command is executed only on the node where the command was issued.

Note

In environments that do not support remote command capability, the `/CLUSTER` qualifier causes the relevant command to be executed on the local node only.

/FACILITY

Specifies the name of the facility from which the partition is being deleted.

/NODE[=node-list]

/NODE=default-node (D)

Specifies that the command is executed on all nodes specified in `node-list`. If `node-list` is omitted, the command is executed only on the node where the command was issued.

/OUTPUT[=filespec]

/OUTPUT=stdout (D)

Specifies that the resulting information is written to the file `filespec`. If `/OUTPUT` or `filespec` is omitted, the standard or default output is used.

Related commands

- CREATE PARTITION
- SHOW PARTITION

DELETE SERVICEPROVIDER

DELETE SERVICEPROVIDER

The **DELETE SERVICEPROVIDER** command deletes an existing RTR serviceprovider.

Use of this command requires the RTR Java Toolkit.

Format

```
DELETE SERVICEPROVIDER serviceprovider_name
```

Command Qualifiers

```
/NODE[=node-list]
```

Defaults

```
/NODE=default-node
```

Description

The **DELETE SERVICEPROVIDER** command deletes the specified serviceprovider. The **DELETE SERVICEPROVIDER** command fails if the serviceprovider does not exist. There is no default value for *serviceprovider_name*.

See the related commands and the RTR Glossary in the *HP Reliable Transaction Router Getting Started* for additional information on this and other Java-related commands.

Parameters

serviceprovider_name

The name of the serviceprovider to delete.

The parameter *serviceprovider_name* is required.

Qualifiers

/NODE[=node-list]

/NODE=default-node(D)

Specifies that the command be executed on all nodes in *node-list*. If *node-list* is omitted, the command is executed only on the local node where the command was issued.

Related Commands

- CREATE SERVICEPROVIDER
- MODIFY SERVICEPROVIDER
- SHOW SERVICEPROVIDER

Examples

The following example shows use of the DELETE SERVICEPROVIDER command to delete the serviceprovider called myservice.

```
RTR> delete service myservice
%RTR-S-SPDELETED, ServiceProvider myservice deleted
```

Error message for delete serviceprovider.

```
RTR> delete service myservice
%RTR-E-SPINUSE, ServiceProvider myservice is currently in use
```

DISCONNECT LINK

DISCONNECT LINK

Disconnects the RTR link to the node identified by the link name.

Removes the DECnet or TCP/IP connection.

Format

```
DISCONNECT LINK linkname [,linkname1,...]
```

Command Qualifiers	Defaults
/CLUSTER	/NOCLUSTER
/LOG	/LOG
/NODE[=node-list]	/NODE=default-node
/OUTPUT[=filespec]	/OUTPUT=stdout

Description

Warning on Use of DISCONNECT LINK Command

The DISCONNECT LINK command is powerful. From the perspective of RTR, disconnecting a link using this command is like abruptly removing the TCP or DECnet connection. Use this command with caution. Be extra cautious when using wildcards in the command, for example "DISCONNECT LINK *", because such commands can remove multiple links simultaneously. Instead of using the wildcard, consider disconnecting each link one at a time, as that will minimize the disruption to the RTR network.

Keep in mind that disconnecting even a single link may cause undesirable behavior, including aborted transactions and quorum loss.

The DISCONNECT LINK command forces the temporary disconnection of a logical link if it has already been established. The link is re-established automatically after a certain time period.

To disconnect the link permanently, use the DISCONNECT LINK command after using the SET LINK command with the /DISABLE qualifier. For more information on the SET LINK command, see its description in this document. To re-establish a link that was permanently disconnected, use the SET LINK command with the /ENABLE qualifier.

Note

- Linkname matching is case sensitive.
 - Linknames must be entered exactly as displayed by the SHOW LINK command; no aliases are allowed.
 - No error is generated if the specified link cannot be found, nor is exit status set to indicate an error.
-

Parameters

linkname

Specifies the name of a link (that is, the node at the other end of a link); linkname may contain wild cards ("*" and "%"), in which case all matching links are disconnected.

Qualifiers

/CLUSTER

/NOCLUSTER (D)

Specifies that the command is executed on all the nodes in the cluster.

If neither /NODE nor /CLUSTER is specified, the command is executed on the nodes specified by the latest SET ENVIRONMENT command. If no SET ENVIRONMENT command has been entered, the command is executed only on the node where the command was issued.

Note

In environments that do not support remote command capability, the /CLUSTER qualifier causes the relevant command to be executed on the local node only.

DISCONNECT LINK

/LOG (D)

/NOLOG

Controls whether a message indicating that the link has been successfully disconnected is displayed.

/NODE[=node-list]

/NODE=default-node (D)

Specifies that the command is executed on all nodes specified in `node-list`. If `node-list` is omitted, the command is executed only on the node where the command was issued.

/OUTPUT[=filespec]

/OUTPUT=stdout (D)

Specifies that the resulting information is written to the file `filespec`. If `/OUTPUT` or `filespec` is omitted, the standard or default output is used.

Related commands

- SET LINK
- SHOW LINK
- CREATE FACILITY
- SHOW FACILITY/LINK

DISCONNECT SERVER

Disconnects the RTR command server (COMSERV) process.

Format

```
DISCONNECT SERVER [nodename]
```

Description

The DISCONNECT SERVER command disconnects the RTR command server. This can be used to refresh the command server context.

Parameters

nodename

Specifies the name of a node.

Qualifiers

/CLUSTER

/NOCLUSTER (D)

Specifies that the command is executed on all the nodes in the cluster.

If neither /NODE nor /CLUSTER is specified, the command is executed on the nodes specified by the latest SET ENVIRONMENT command. If no SET ENVIRONMENT command has been entered, the command is executed only on the node where the command was issued.

Note

In environments that do not support remote command capability, the /CLUSTER qualifier causes the relevant command to be executed on the local node only.

/DAEMON

Adding this qualifier will kill both command server and daemon process. To stop RTRACP process, use "stop rtr" command.

DISCONNECT SERVER

/NODE[=node-list]

/NODE=default-node (D)

Specifies that the command is executed on all nodes specified in `node-list`. If `node-list` is omitted, the command is executed only on the node where the command was issued.

/OUTPUT[=filespec]

/OUTPUT=stdout (D)

Specifies that the resulting information is written to the file `filespec`. If `/OUTPUT` or `filespec` is omitted, the standard or default output is used.

DISPLAY BAR

The **DISPLAY BAR** command displays a bar graph in a monitor picture.

Note

This command is not available in the RTR web browser interface.

Format

DISPLAY BAR expression

Command Qualifiers	Defaults
/AVERAGE=(keyword,...)	None
/BELL[=Boolean-expression]	/NOBELL
/BLANK[=Boolean-expression]	/NOBLANK
/BLINK[=Boolean-expression]	/NOBLINK
/BOLD[=Boolean-expression]	/NOBOLD
/CHARACTER=char	/CHARACTER="a"
/COLSPAN=n	/COLSPAN=1
/DAMPING=damping-factor	/NODAMPING
/DESCRIPTION="text-string"	None
/DISPLAY=NOHTML	/DISPLAY=TEXT
/DISPLAY=NOTEXT	/DISPLAY=HTML
/HEADER	/NOHEADER
/LABEL=text	/NOLABEL
/LENGTH=nr-chars	/LENGTH=50
/MAXIMUM=max-value	/MAXIMUM=10
/MINIMUM=min-value	/MINIMUM=0
/PARAGRAPH	None
/RATE=interval	/NORATE
/REVERSE[=Boolean-expression]	/NOREVERSE
/ROWS=nr-rows	/ROWS=1
/SELECT[=Boolean-expression]	/NOSELECT
/SEPARATE=(keyword,...)	None
/[NO]TABLE	None
/TOTALIZE=(keyword,...)	None
/UNDERLINE[=Boolean-expression]	/NOUNDERLINE
/VALUE=[value-type]	/VALUE=CURRENT
/X[=column]	Column of previous item
/Y[=row]	Next free row

DISPLAY BAR

Description

The DISPLAY BAR command displays the expression as a bar graph in a monitor picture. It can be used within a monitor file or issued at the RTR prompt when interactively defining a monitor picture for use in a subsequent MONITOR command.

Note that the introduction of the /SEPARATE, /TOTALIZE and /AVERAGE qualifiers has superseded the qualifiers /FACILITY, /LINK, /PARTITION, /NODE and /PROCESS. These superseded qualifiers are no longer described here, however they are still supported. Chapter 8 and Appendix A contain more information on monitor pictures and monitor files.

Parameters

expression

Specifies the quantity to be displayed. Expression can be either the name of a single data item or an expression combining several items using simple arithmetic operations and constants. In the latter case, expression must be in quotes.

Note

A Boolean expression can contain a remembered expression. For more information on remembered expressions, see REMEMBER EXPRESSION.

Qualifiers

/AVERAGE=(keyword,...)

/NOAVERAGE

Specifies that the items being monitored relating to keyword are displayed as an average. This allows a number of items to be averaged in one qualifier.

The keyword can be one of the following:

Keyword	Meaning
NODE	Node data items
LINK	Link data items
FACILITY	Facility data items

Keyword	Meaning
PROCESS	Process data items
PARTITION	Partition data items
FE_TRANSACTION	Frontend transaction data items
TR_TRANSACTION	Router transaction data items
BE_TRANSACTION	Backend transaction data items

DISPLAY BAR

/BELL[=Boolean-expression]

/NOBELL (D)

Sends a bell character to the terminal if Boolean-expression evaluates to True (non-zero).

/BLINK[=Boolean-expression]

/NOBLINK (D)

Specifies that the displayed value blinks if Boolean-expression evaluates to True (non-zero).

/BLANK[=Boolean-expression]

/NOBLANK (D)

Specifies that the displayed value is replaced by blanks if Boolean-expression evaluates to True (non-zero).

/BOLD[=Boolean-expression]

/NOBOLD (D)

Specifies that the item is displayed in high intensity if Boolean-expression evaluates to True (non-zero).

/CHARACTER[=char]

/NOCHARACTER

/CHARACTER="a" (D)

Specifies the character used to draw bar charts. The line drawing character set is used to display them. By default, the character "a" is used, which corresponds to a rectangular block in the character set. If /NOCHARACTER is given, no characters are displayed and the bar is visible only if attributes have been specified. This can be used to draw a scale behind the bar chart.

/COLSPAN=n

/COLSPAN=1 (D)

Specifies the number of columns the item is to span in the HTML table where it is displayed. The default is one column.

/DAMPING[=damping-factor]

/NODAMPING (D)

Specifies that the value displayed is to fluctuate more slowly than the raw measured value. The default for damping-factor is one. Damping is only relevant if /VALUE=CURRENT.

/DESCRIPTION="text-string"

Provides a descriptive text for the item being displayed. Column headers are often cryptic as little room is available. The browser will display the descriptive text in a popup window (currently, Internet Explorer only).

/DISPLAY

Suppresses the entire output of the DISPLAY command in the HTML (DISPLAY=NOHTML) or TEXT (DISPLAY=NOTEXT) view. By default, items are displayed in both text and html views.

/HEADER

/NOHEADER (D)

Indicates the item is part of a table header. This qualifier should be attached to the first item of a new row.

/LABEL=text

/NOLABEL (D)

Specifies the text used to label the value being displayed. Symbols are substituted at display time. (See Section A.2, Substitution Symbols.)

/LENGTH[=nr-chars]

/LENGTH=50 (D)

Specifies the number of characters in a bar chart representing the maximum value. The default is 50.

/MAXIMUM[=max-value]

/MAXIMUM=10 (D)

Specifies the maximum value represented on a bar chart. The default is 10.

/MINIMUM[=min-value]

/MINIMUM=0 (D)

Specifies the minimum value represented on a bar chart. The default is zero.

/PARAGRAPH

Causes a display item to be formatted as the first item of a new paragraph in the HTML output. This qualifier is effective only while in text mode, after the /NOTABLE qualifier has been used.

/RATE[=interval]

/NORATE (D)

Specifies that the rate of change of the expression is to be displayed rather than the absolute value. When /RATE is used, interval specifies the time interval in seconds used to calculate the rate of change. This has no effect on the sampling; it simply allows the rate to be displayed in another unit. For example, displaying the start transaction counter with /RATE=60 results in transactions per minute being displayed instead of per second.

DISPLAY BAR

/REVERSE[=Boolean-expression]

/NOVERSE (D)

Specifies that the item is displayed with the foreground and background visual attributes swapped if Boolean-expression evaluates to True (non-zero).

/ROWS[=nr-rows]

/ROWS=1 (D)

Specifies how many rows are used to display the item. This is only meaningful if /SEPARATE is also specified. The default number of rows is one.

/SELECT[=Boolean-expression]

/NOSELECT (D)

Displays the item if Boolean-expression evaluates to True (non-zero).

/SEPARATE=(keyword,...)

/NOSEPARATE

Specifies that the items being monitored relating to keyword are separated from each other and displayed as a list. This allows a number of items to be separated in one qualifier.

The keyword can be one of the following:

Keyword	Meaning
NODE	Node data items
LINK	Link data items
FACILITY	Facility data items
PROCESS	Process data items
PARTITION	Partition data items
FE_TRANSACTION	Frontend transaction data items
TR_TRANSACTION	Router transaction data items
BE_TRANSACTION	Backend transaction data items

/TABLE

/NOTABLE

Indicates the start of a new table in the monitor output. This qualifier should be attached to the first item of a new row. Specifying /NOTABLE causes any current table to be closed and a new text section to be started in the HTML output.

/TOTALIZE=(keyword,...)

/NOTOTALIZE

Specifies that the items being monitored relating to keyword are added together and displayed as a total.

The keyword can be any of the following:

Keyword	Meaning
NODE	Node data items
LINK	Link data items
FACILITY	Facility data items
PROCESS	Process data items
PARTITION	Partition data items
FE_TRANSACTION	Frontend transaction data items
TR_TRANSACTION	Router transaction data items
BE_TRANSACTION	Backend transaction data items

/UNDERLINE[=Boolean-expression]

/NOUNDERLINE (D)

Specifies that the displayed value is underlined if Boolean-expression evaluates to True (non-zero).

/VALUE[=value-type]

/VALUE=CURRENT (D)

Specifies how the value is processed before being displayed. Value-type can be one of the following keywords:

CURRENT	(default) Displays the current value of expression
AVERAGE	Displays the average value of expression since the MONITOR command was issued
MINIMUM	Displays the minimum value of expression since the MONITOR command was issued
MAXIMUM	Displays the maximum value of expression since the MONITOR command was issued

Use the MONITOR/RESUME command to reset average, maximum or minimum values.

DISPLAY BAR

/X[=column]

/X=previous-column (D)

Specifies the screen column where the item is displayed (the left-most column is 1). By default, items are displayed in the same column as defined by the previous DISPLAY command.

/Y[=row]

/Y=next-free-row (D)

Specifies the screen row where the item is displayed (top row is 1). By default, items are displayed on the next free row after the item defined by the previous DISPLAY command.

Related commands

- CLEAR
- DISPLAY NUMERIC
- DISPLAY SYMBOLIC
- DISPLAY TEXT
- MONITOR
- REMEMBER EXPRESSION
- SHOW DISPLAY

DISPLAY NUMERIC

The **DISPLAY NUMERIC** command displays a number in a monitor picture.

Note

This command is not available in the RTR web browser interface.

Format

DISPLAY NUMERIC expression

Command Qualifiers	Defaults
/AVERAGE=(keyword,...)	None
/BELL=Boolean-expression	/NOBELL
/BLANK=Boolean-expression	/NOBLANK
/BLINK=Boolean-expression	/NOBLINK
/BOLD=Boolean-expression	/NOBOLD
/COLSPAN=n	/COLSPAN=1
/DAMPING=damping-factor	/NODAMPING
/DECIMALS=decimal-places	/DECIMALS=0
/DESCRIPTION="text-string"	None
/DISPLAY=NOHTML	/DISPLAY=TEXT
/DISPLAY=NOTEXT	/DISPLAY=HTML
/HEADER	/NOHEADER
/LABEL=text	/NOLABEL
/PARAGRAPH	None
/RATE=interval	/NORATE
/REVERSE=[Boolean-expression]	/NOREVERSE
/ROWS=nr-rows	/ROWS=1
/SELECT=Boolean-expression	/NOSELECT
/SEPARATE=(keyword,...)	None
/[NO]TABLE	None
/TOTALIZE=(keyword,...)	None
/UNDERLINE=[Boolean-expression]	/NOUNDERLINE
/VALUE=value-type	/VALUE=CURRENT
/WIDTH=field-width	/WIDTH=1
/X[=column]	Column of previous item
/Y[=row]	Next free row

DISPLAY NUMERIC

Description

The DISPLAY NUMERIC command displays the specified expression as a number in a monitor picture. It can be used within a monitor file or issued at the RTR prompt when interactively defining a monitor picture for use in a subsequent MONITOR command.

Note that the introduction of the /SEPARATE, /TOTALIZE and /AVERAGE qualifiers has superseded the qualifiers /FACILITY, /LINK, /PARTITION, /NODE and /PROCESS. These superseded qualifiers are no longer described here, however they are still supported.

Parameters

expression

Specifies the quantity to be displayed. Expression can be either the name of a single data item or an expression combining several items using simple arithmetic operations and constants. In the latter case, EXPRESSION must be in quotes.

Note

A Boolean expression can contain a remembered expression. For more information on remembered expressions, see REMEMBER EXPRESSION.

Qualifiers

/AVERAGE=(keyword,...)

/NOAVERAGE

Specifies that the items being monitored relating to keyword are displayed as an average. This allows a number of items to be averaged in one qualifier.

The keyword can be one of the following:

Keyword	Meaning
NODE	Node data items
LINK	Link data items
FACILITY	Facility data items
PROCESS	Process data items

Keyword	Meaning
PARTITION	Partition data items
FE_TRANSACTION	Frontend transaction data items
TR_TRANSACTION	Router transaction data items
BE_TRANSACTION	Backend transaction data items

/BELL[=Boolean-expression]

/NOBELL (D)

Sends a bell character to the terminal if Boolean-expression evaluates to True (non-zero).

/BLANK[=Boolean-expression]

/NOBLANK (D)

Specifies that the displayed value is replaced by blanks if Boolean-expression evaluates to True (non-zero).

/BLINK[=Boolean-expression]

/NOBLINK (D)

Specifies that the displayed value blinks if Boolean-expression evaluates to True (non-zero).

/BOLD[=Boolean-expression]

/NOBOLD (D)

Specifies that the item is displayed in high intensity if Boolean-expression evaluates to True (non-zero).

/COLSPAN=n

/COLSPAN=1 (D)

Specifies the number of columns the item is to span in the HTML table where it is displayed. The default is one column.

/DAMPING[=damping-factor]

/NODAMPING (D)

Specifies that the value displayed is to fluctuate more slowly than the raw measured value. The default for damping-factor is one. Damping is only relevant if /VALUE=CURRENT.

/DECIMALS[=decimal-places]

/DECIMALS=0 (D)

Specifies the number of digits to appear after the decimal point when displaying a numeric. The default for decimal-places is zero, that is, numbers are displayed as integers.

DISPLAY NUMERIC

/DESCRIPTION="text-string"

Provides a descriptive text for the item being displayed. Column headers are often cryptic as little room is available. The browser will display the descriptive text in a popup window (currently, Internet Explorer only).

/DISPLAY

Suppresses the entire output of the DISPLAY command in the HTML (DISPLAY=NOHTML) or TEXT (DISPLAY=NOTEXT) view. By default, items are displayed in both text and html views.

/HEADER

/NOHEADER (D)

Indicates the item is part of a table header. This qualifier should be attached to the first item of a new row.

/LABEL=text

/NOLABEL (D)

Specifies the text used to label the value being displayed. Symbols are substituted at display time. (See Section A.2, Substitution Symbols.)

/PARAGRAPH

Causes a display item to be formatted as the first item of a new paragraph in the HTML output. This qualifier is effective only while in text mode, after the /NOTABLE qualifier has been used.

/RATE[=interval]

/NORATE (D)

Specifies that the rate of change of the expression is to be displayed rather than the absolute value. When /RATE is used, interval specifies the time interval in seconds used to calculate the rate of change. This has no effect on the sampling; it simply allows the rate to be displayed in another unit. For example, displaying the start transaction counter with /RATE=60 results in transactions per minute being displayed instead of per second.

/REVERSE[=Boolean-expression]

/NOREVERSE (D)

Specifies that the item is displayed with the foreground and background visual attributes swapped if Boolean-expression evaluates to True (non-zero).

/ROWS[=nr-rows]

/ROWS=1 (D)

Specifies how many rows are used to display the item. This is only meaningful if /SEPARATE is also specified. The default number of rows is one.

/SELECT[=Boolean-expression]

/NOSELECT (D)

Displays the item if Boolean-expression evaluates to True (non-zero).

/SEPARATE=(keyword,...)

/NOSEPARATE

Specifies that the items being monitored relating to keyword are separated from each other and displayed as a list. This allows a number of items to be separated in one qualifier.

The keyword can be one of the following:

Keyword	Meaning
NODE	Node data items
LINK	Link data items
FACILITY	Facility data items
PROCESS	Process data items
PARTITION	Partition data items
FE_TRANSACTION	Frontend transaction data items
TR_TRANSACTION	Router transaction data items
BE_TRANSACTION	Backend transaction data items

/TABLE

/NOTABLE

Indicates the start of a new table in the monitor output. This qualifier should be attached to the first item of a new row. Specifying /NOTABLE causes any current table to be closed and a new text section to be started in the HTML output.

/TOTALIZE=(keyword,...)

/NOTOTALIZE

Specifies that the items being monitored relating to keyword are added together and displayed as a total.

The keyword can be any of the following:

Keyword	Meaning
NODE	Node data items

DISPLAY NUMERIC

Keyword	Meaning
LINK	Link data items
FACILITY	Facility data items
PROCESS	Process data items
PARTITION	Partition data items
FE_TRANSACTION	Frontend transaction data items
TR_TRANSACTION	Router transaction data items
BE_TRANSACTION	Backend transaction data items

/UNDERLINE[=Boolean-expression]

/NOUNDERLINE (D)

Specifies that the displayed value is underlined if Boolean-expression evaluates to True (non-zero).

/VALUE[=value-type]

/VALUE=CURRENT (D)

Specifies how the value is processed before being displayed. Value-type can be one of the following keywords:

CURRENT	(default) Displays the current value of expression
AVERAGE	Displays the average value of expression since the MONITOR command was issued
MINIMUM	Displays the minimum value of expression since the MONITOR command was issued
MAXIMUM	Displays the maximum value of expression since the MONITOR command was issued

Use the MONITOR/RESUME command to reset average, maximum or minimum values.

/WIDTH[=field-width]

/WIDTH=1 (D)

Specifies the width (in number of characters) to display a numeric. If more characters than width are required, the number will be shifted to the right. No data will be lost, but columns of numbers will no longer line up. If /WIDTH=1 (the default) is specified, numbers are displayed left justified.

Numeric values that are too large to fit within the field width of a monitor picture when displayed on a terminal are rescaled and displayed with a suffix indicating the scale. The number of significant figures displayed depends on the available field width.

/X[=column]

/X=previous-column (D)

Specifies the screen column where the item is displayed (the left-most column is 1). By default, items are displayed in the same column as defined by the previous DISPLAY command.

/Y[=row]

/Y=next-free-row (D)

Specifies the screen row where the item is displayed (top row is 1). By default, items are displayed on the next free row after the item defined by the previous DISPLAY command.

Related commands

- CLEAR
- DISPLAY BAR
- DISPLAY SYMBOLIC
- DISPLAY TEXT
- MONITOR
- REMEMBER EXPRESSION
- SHOW DISPLAY

Examples

See Section A.1 for examples of how to use the DISPLAY NUMERIC command.

DISPLAY STRING

DISPLAY STRING

The **DISPLAY STRING** displays a string in a monitor picture.

Note

This command is not available in the RTR web browser interface.

Format

DISPLAY STRING expression

Command Qualifiers	Defaults
/AVERAGE=(keyword,...)	None
/BELL=[Boolean-expression]	/NOBELL
/BLANK=[Boolean-expression]	/NOBLANK
/BLINK=[Boolean-expression]	/NOBLINK
/BOLD=[Boolean-expression]	/NOBOLD
/COLSPAN=n	/COLSPAN=1
/DESCRIPTION="text-string"	None
/DISPLAY=NOHTML	/DISPLAY=TEXT
/DISPLAY=NOTEXT	/DISPLAY=HTML
/HEADER	/NOHEADER
/JUSTIFY=keyword	/JUSTIFY=LEFT
/LABEL=text	/NOLABEL
/PARAGRAPH	None
/REVERSE=[Boolean-expression]	/NOREVERSE
/ROWS=nr-rows	/ROWS=1
/SELECT=[Boolean-expression]	/NOSELECT
/SEPARATE=(keyword,...)	None
/[NO]TABLE	None
/TOTALIZE=(keyword,...)	None
/UNDERLINE=[Boolean-expression]	/NOUNDERLINE
/WIDTH=field-width	/WIDTH=0
/X=[column]	Column of previous item
/Y=[row]	Next free row

Description

The **DISPLAY STRING** command displays the specified expression as an alphanumeric in a monitor picture. It can be used within a monitor file or issued at the RTR prompt when interactively defining a monitor picture for use in a subsequent **MONITOR** command.

Note that the introduction of the /SEPARATE, /TOTALIZE and /AVERAGE qualifiers has superseded the qualifiers /FACILITY, /LINK, /PARTITION, /NODE and /PROCESS. These superseded qualifiers are no longer described here, however they are still supported.

Parameters

expression

The string you want to display; enclose it in quotation marks. Expression can be the name of a single RTR data item.

Note

A Boolean expression can contain a remembered expression. For more information on remembered expressions, see REMEMBER EXPRESSION.

Qualifiers

/AVERAGE=(keyword,...)

/NOAVERAGE

Specifies that the items being monitored relating to keyword are displayed as an average. This allows a number of items to be averaged in one qualifier.

The keyword can be one of the following:

Keyword	Meaning
NODE	Node data items
LINK	Link data items
FACILITY	Facility data items
PROCESS	Process data items
PARTITION	Partition data items
FE_TRANSACTION	Frontend transaction data items
TR_TRANSACTION	Router transaction data items
BE_TRANSACTION	Backend transaction data items

/BELL[=Boolean-expression]

/NOBELL (D)

Sends a bell character to the terminal if Boolean-expression evaluates to True (non-zero).

DISPLAY STRING

/BLANK[=Boolean-expression]

/NOBLANK (D)

Specifies that the displayed value is replaced by blanks if Boolean-expression evaluates to True (non-zero).

/BLINK[=Boolean-expression]

/NOBLINK (D)

Specifies that the displayed value blinks if Boolean-expression evaluates to True (non-zero).

/BOLD[=Boolean-expression]

/NOBOLD (D)

Specifies that the item is displayed in high intensity if Boolean-expression evaluates to True (non-zero).

/COLSPAN=n

/COLSPAN=1 (D)

Specifies the number of columns the item is to span in the HTML table where it is displayed. The default is one column.

/DESCRIPTION="text-string"

Provides a descriptive text for the item being displayed. Column headers are often cryptic as little room is available. The browser will display the descriptive text in a popup window (currently, Internet Explorer only).

/DISPLAY

Suppresses the entire output of the DISPLAY command in the HTML (DISPLAY=NOHTML) or TEXT (DISPLAY=NOTEXT) view. By default, items are displayed in both text and html views.

/HEADER

/NOHEADER (D)

Indicates the item is part of a table header. This qualifier should be attached to the first item of a new row.

/JUSTIFY=keyword

/JUSTIFY=LEFT (D)

Specifies whether justification is left, right or centered in the available width. (The keyword may be LEFT, RIGHT or CENTERED.) The /WIDTH qualifier must be greater than zero for /JUSTIFY to operate. If the available width is smaller than the string, truncation will occur.

/LABEL=text

/NOLABEL (D)

Specifies the text used to label the value being displayed. Symbols are substituted at display time. (See Section A.2, Substitution Symbols.)

/PARAGRAPH

Causes a display item to be formatted as the first item of a new paragraph in the HTML output. This qualifier is effective only while in text mode, after the /NOTABLE qualifier has been used.

/REVERSE[=Boolean-expression]

/NOREVERSE (D)

Specifies that the item is displayed with the foreground and background visual attributes swapped if Boolean-expression evaluates to True (non-zero).

/ROWS[=nr-rows]

/ROWS=1 (D)

Specifies how many rows are used to display the item. This is only meaningful if /SEPARATE is also specified. The default number of rows is one.

/SELECT[=Boolean-expression]

/NOSELECT (D)

Displays the item if Boolean-expression evaluates to True (non-zero).

/SEPARATE=(keyword,...)

/NOSEPARATE

Specifies that the items being monitored relating to keyword are separated from each other and displayed as a list. This allows a number of items to be separated in one qualifier.

The keyword can be one of the following:

Keyword	Meaning
NODE	Node data items
LINK	Link data items
FACILITY	Facility data items
PROCESS	Process data items
PARTITION	Partition data items
FE_TRANSACTION	Frontend transaction data items
TR_TRANSACTION	Router transaction data items

DISPLAY STRING

Keyword	Meaning
BE_TRANSACTION	Backend transaction data items

/TABLE **/NOTABLE**

Indicates the start of a new table in the monitor output. This qualifier should be attached to the first item of a new row. Specifying **/NOTABLE** causes any current table to be closed and a new text section to be started in the HTML output.

/TOTALIZE=(keyword,...) **/NOTOTALIZE**

Specifies that the items being monitored relating to keyword are added together and displayed as a total.

The keyword can be any of the following:

Keyword	Meaning
NODE	Node data items
LINK	Link data items
FACILITY	Facility data items
PROCESS	Process data items
PARTITION	Partition data items
FE_TRANSACTION	Frontend transaction data items
TR_TRANSACTION	Router transaction data items
BE_TRANSACTION	Backend transaction data items

/UNDERLINE[=Boolean-expression] **/NOUNDERLINE (D)**

Specifies that the displayed value is underlined if Boolean-expression evaluates to True (non-zero).

/WIDTH[=field-width] **/WIDTH=0 (D)**

Specifies the width (in number of characters) to display the string. If **/WIDTH=0** is specified (the default), the string is displayed as entered. If the width is greater than zero, the **/JUSTIFY** qualifier is activated.

/X[=column]

/X=previous-column (D)

Specifies the screen column where the item is displayed (the left-most column is 1). By default, items are displayed in the same column as defined by the previous DISPLAY command.

/Y[=row]

/Y=next-free-row (D)

Specifies the screen row where the item is displayed (top row is 1). By default, items are displayed on the next free row after the item defined by the previous DISPLAY command.

Related commands

- CLEAR
- DISPLAY BAR
- DISPLAY SYMBOLIC
- DISPLAY TEXT
- MONITOR
- REMEMBER EXPRESSION
- SHOW DISPLAY

DISPLAY SYMBOLIC

DISPLAY SYMBOLIC

The **DISPLAY SYMBOLIC** command displays a text in a monitor picture depending on the result of an expression evaluation.

Note

This command is not available in the RTR web browser interface.

Format

DISPLAY SYMBOLIC expression "text-string" ["text-string"]...

Command Qualifiers	Defaults
/BELL[=Boolean-expression]	/NOBELL
/BLANK[=Boolean-expression]	/NOBLANK
/BLINK[=Boolean-expression]	/NOBLINK
/BOLD[=Boolean-expression]	/NOBOLD
/COLSPAN=n	/COLSPAN=1
/DESCRIPTION="text-string"	None
/DISPLAY=NOHTML	/DISPLAY=TEXT
/DISPLAY=NOTEXT	/DISPLAY=HTML
/HEADER	/NOHEADER
/PARAGRAPH	None
/REVERSE[=Boolean-expression]	/NOREVERSE
/[NO]TABLE	None
/UNDERLINE[=Boolean-expression]	/NOUNDERLINE
/X[=column]	Column of previous item
/Y[=row]	Next free row

Description

The DISPLAY SYMBOLIC command displays one of the text strings depending on the value of expression. The first string is output if the expression's value is zero (0), the second string is output if the expression's value is 1, and so on. If the expression has a value for which there is no corresponding entry in the list of texts, the value itself is printed. Because there is a limit of 255 characters on the size of one command to RTR, large numbers of long strings should be avoided.

The command can be used within a monitor file or issued at the RTR prompt when interactively defining a monitor picture for use in a subsequent MONITOR command.

Parameters

expression

The expression to be evaluated. Expression can either be the name of a single data item, or an expression combining several data items using simple arithmetic operations and constants. In the latter case, the data items must all be of the same type and expression must be enclosed in quotation marks.

Note

A Boolean expression can contain a remembered expression. For more information on remembered expressions, see REMEMBER EXPRESSION.

Qualifiers

/BELL[=Boolean-expression]

/NOBELL (D)

Sends a bell character to the terminal if Boolean-expression evaluates to True (non-zero).

/BLANK[=Boolean-expression]

/NOBLANK (D)

Specifies that the displayed value is replaced by blanks if Boolean-expression evaluates to True (non-zero).

/BLINK[=Boolean-expression]

/NOBLINK (D)

Specifies that the displayed value blinks if Boolean-expression evaluates to True (non-zero).

/BOLD[=Boolean-expression]

/NOBOLD (D)

Specifies that the item is displayed in high intensity if Boolean-expression evaluates to True (non-zero).

/COLSPAN=n

/COLSPAN=1 (D)

Specifies the number of columns the item is to span in the HTML table where it is displayed. The default is one column.

DISPLAY SYMBOLIC

/DESCRIPTION="text-string"

Provides a descriptive text for the item being displayed. Column headers are often cryptic as little room is available. The browser will display the descriptive text in a popup window (currently, Internet Explorer only).

/DISPLAY

Suppresses the entire output of the DISPLAY command in the HTML (DISPLAY=NOHTML) or TEXT (DISPLAY=NOTEXT) view. By default, items are displayed in both text and html views.

/HEADER

/NOHEADER (D)

Indicates the item is part of a table header. This qualifier should be attached to the first item of a new row.

/PARAGRAPH

Causes a display item to be formatted as the first item of a new paragraph in the HTML output. This qualifier is effective only while in text mode, after the /NOTABLE qualifier has been used.

/REVERSE[=Boolean-expression]

/NOREVERSE (D)

Specifies that the item is displayed with the foreground and background visual attributes swapped if Boolean-expression evaluates to True (non-zero).

/TABLE

/NOTABLE

Indicates the start of a new table in the monitor output. This qualifier should be attached to the first item of a new row. Specifying /NOTABLE causes any current table to be closed and a new text section to be started in the HTML output.

/UNDERLINE[=Boolean-expression]

/NOUNDERLINE (D)

Specifies that the displayed value is underlined if Boolean-expression evaluates to True (non-zero).

/X[=column]

/X=previous-column (D)

Specifies the screen column where the item is displayed (the left-most column is 1). By default, items are displayed in the same column as defined by the previous DISPLAY command.

/Y[=row]

/Y=next-free-row (D)

Specifies the screen row where the item is displayed (top row is 1). By default, items are displayed on the next free row after the item defined by the previous DISPLAY command.

Related commands

- CLEAR
- DISPLAY BAR
- DISPLAY NUMERIC
- DISPLAY TEXT
- MONITOR
- REMEMBER EXPRESSION
- SHOW DISPLAY

Examples

See Section A.1 for examples of how to use the DISPLAY SYMBOLIC command.

DISPLAY TEXT

DISPLAY TEXT

The **DISPLAY TEXT** command displays text in a monitor picture.

Note

This command is not available in the RTR web browser interface.

Format

DISPLAY TEXT text

Command Qualifiers	Defaults
/BELL[=Boolean-expression]	/NOBELL
/BLANK[=Boolean-expression]	/NOBLANK
/BLINK[=Boolean-expression]	/NOBLINK
/BOLD[=Boolean-expression]	/NOBOLD
/COLSPAN=n	/COLSPAN=1
/DESCRIPTION="text-string"	None
/DISPLAY=NOHTML	/DISPLAY=TEXT
/DISPLAY=NOTEXT	/DISPLAY=HTML
/FACILITY	/NOFACILITY
/HEADER	/NOHEADER
/LINK	/NOLINK
/MONITOR-HYPERLINK	None
/NODE	/NODE
/PARAGRAPH	None
/PROCESS	/NOPROCESS
/REVERSE[=Boolean-expression]	/NOREVERSE
/SELECT[=Boolean-expression]	/NOSELECT
/[NO]TABLE	None
/UNDERLINE[=Boolean-expression]	/NOUNDERLINE
/X[=column]	Column of previous item
/Y[=row]	Next free row

Description

The **DISPLAY TEXT** command displays the specified text in a monitor picture. It can be used within a monitor file or issued at the RTR prompt when interactively defining a monitor picture for use in a subsequent **MONITOR** command.

Parameters

text

Specifies the text to be displayed. This text may contain any of the substitution symbols. See Section A.2, Substitution Symbols.

Note

A Boolean expression can contain a remembered expression. For more information on remembered expressions, see REMEMBER EXPRESSION.

Qualifiers

/BELL[=Boolean-expression]

/NOBELL (D)

Sends a bell character to the terminal if Boolean-expression evaluates to True (non-zero).

/BLANK[=Boolean-expression]

/NOBLANK (D)

Specifies that the displayed value is replaced by blanks if Boolean-expression evaluates to True (non-zero).

/BLINK[=Boolean-expression]

/NOBLINK (D)

Specifies that the displayed value blinks if Boolean-expression evaluates to True (non-zero).

/BOLD[=Boolean-expression]

/NOBOLD (D)

Specifies that the item is displayed in high intensity if Boolean-expression evaluates to True (non-zero).

/COLSPAN=n

/COLSPAN=1 (D)

Specifies the number of columns the item is to span in the HTML table where it is displayed. The default is one column.

/DESCRIPTION="text-string"

Provides a descriptive text for the item being displayed. Column headers are often cryptic as little room is available. The browser will display the descriptive text in a popup window (currently, Internet Explorer only).

DISPLAY TEXT

/DISPLAY

Suppresses the entire output of the DISPLAY command in the HTML (DISPLAY=NOHTML) or TEXT (DISPLAY=NOTEXT) view. By default, items are displayed in both text and html views.

/FACILITY

/NOFACILITY (D)

Specifies that the symbol substitution in the text is carried out as if a facility data item were being displayed. This means that the link name symbol (\$LINK_NAME) and the process-related symbols (\$PROCESS_ID, \$PROCESS_NAME, \$IMAGE_NAME, \$FULL_IMAGE_NAME) are always replaced by the text "-ALL-".

The facility name symbol (\$FACILITY_NAME) will be replaced by the text "-ALL-" unless MONITOR/FACILITY=facility-name is used; in this case \$FACILITY_NAME is replaced by facility-name.

/HEADER

/NOHEADER (D)

Indicates the item is part of a table header. This qualifier should be attached to the first item of a new row.

/LINK

/NOLINK (D)

Specifies that symbol substitution in the text is carried out as if a link data item were being displayed. This means that the facility name symbol (\$FACILITY_NAME) and the process related symbols (\$PROCESS_ID, \$PROCESS_NAME, \$IMAGE_NAME, \$FULL_IMAGE_NAME) are always replaced by the text "-ALL-". The link name symbol (\$LINK_NAME) is replaced by the text "-ALL-" unless MONITOR/LINK=node-name is used, in which case \$LINK_NAME is replaced by node-name.

/MONITOR-HYPERLINK=[monitor-name]

Specifies a monitor picture name. The first occurrence of the string in the text item being displayed will act as a hyperlink to the monitor screen.

/NODE

/NONODE

Specifies that symbol substitution in the text is carried out as if a node data item were being displayed. This means that the facility name symbol (\$FACILITY_NAME), the link name symbol (\$LINK_NAME) and the process-related symbols (\$PROCESS_ID, \$PROCESS_NAME, \$IMAGE_NAME, \$FULL_IMAGE_NAME) are always replaced by the text "-ALL-".

/PARAGRAPH

Causes a display item to be formatted as the first item of a new paragraph in the HTML output. This qualifier is effective only while in text mode, after the **/NOTABLE** qualifier has been used.

/PROCESS**/NOPROCESS (D)**

Specifies that symbol substitution in the text is carried out as if a process data item were being displayed. This means that the facility name symbol (**\$FACILITY_NAME**) and the link name symbol (**\$LINK_NAME**) are always replaced by the text "-ALL-".

The process-related symbols (**\$PROCESS_ID**, **\$PROCESS_NAME**, **\$IMAGE_NAME**, **\$FULL_IMAGE_NAME**) are replaced by the text "-ALL-" unless **MONITOR/IDENTIFICATION=process-id** is used. In this case they are replaced by the appropriate strings for the process specified by **process-id**.

/REVERSE[=Boolean-expression]**/NOREVERSE (D)**

Specifies that the item is displayed with the foreground and background visual attributes swapped if **Boolean-expression** evaluates to True (non-zero).

/SELECT[=Boolean-expression]**/NOSELECT (D)**

Displays the item if **Boolean-expression** evaluates to True (non-zero).

/TABLE**/NOTABLE**

Indicates the start of a new table in the monitor output. This qualifier should be attached to the first item of a new row. Specifying **/NOTABLE** causes any current table to be closed and a new text section to be started in the HTML output.

/UNDERLINE[=Boolean-expression]**/NOUNDERLINE (D)**

Specifies that the displayed value is underlined if **Boolean-expression** evaluates to True (non-zero).

/X[=column]**/X=previous-column (D)**

Specifies the screen column where the item is displayed (the left-most column is 1). By default, items are displayed in the same column as defined by the previous **DISPLAY** command.

DISPLAY TEXT

/Y[=row]

/Y=next-free-row (D)

Specifies the screen row where the item is displayed (top row is 1). By default, items are displayed on the next free row after the item defined by the previous DISPLAY command.

Related commands

- CLEAR
- DISPLAY NUMERIC
- DISPLAY BAR
- DISPLAY SYMBOLIC
- MONITOR
- REMEMBER EXPRESSION
- SHOW DISPLAY

Examples

See Section A.1, Interactive Definition of a Monitor Picture, for examples of how to use the DISPLAY TEXT command.

DO

The **DO** command executes an operating system command.

Note

This command is not available in the RTR web browser interface.

Format

DO [operating-system-command]

Command Qualifiers

/CLUSTER

/NODE[=node-list]

/OUTPUT[=filespec]

Defaults

/NOCLUSTER

/NODE=default-node

/OUTPUT=stdout

Description

The DO command enables an operating system command to be executed from RTR. By using the /NODE and /CLUSTER qualifiers, the command can be executed on one or more remote nodes. (Note that the SPAWN command does not have this ability).

The DO command is only suitable for commands producing line-oriented output; use SPAWN to execute a local operating system command that produces screen-oriented output (for example, the OpenVMS MONITOR SYSTEM command, or screen mode editors).

Parameters

operating-system command

The operating system command that you want to execute.

Qualifiers

/CLUSTER

/NOCLUSTER (D)

Specifies that the command is executed on all the nodes in the cluster.

DO

If neither `/NODE` nor `/CLUSTER` is specified, the command is executed on the nodes specified by the latest `SET ENVIRONMENT` command. If no `SET ENVIRONMENT` command has been entered, the command is executed only on the node where the command was issued.

Note

In environments that do not support remote command capability, the `/CLUSTER` qualifier causes the relevant command to be executed on the local node only.

`/NODE[=node-list]`

`/NODE=default-node (D)`

Specifies that the command is executed on all nodes specified in `node-list`. If `node-list` is omitted, the command is executed only on the node where the command was issued.

`/OUTPUT[=filespec]`

`/OUTPUT=stdout (D)`

Specifies that the resulting information is written to the file `filespec`. If `/OUTPUT` or `filespec` is omitted, the standard or default output is used.

Related commands

- SPAWN

Examples

1.

```
RTR> DO/CLUSTER SHOW TIME
```

This command shows the time on all nodes in a OpenVMS cluster.

2.

```
RTR> DO/NODE=(TR2,TR1) SHOW LOGICAL MYLOGICAL
```

This command examines the logical name `MYLOGICAL` on nodes `TR2` and `TR1`.

3.

```
RTR> SET ENVIRONMENT/NODE=(TR2,TR1)
RTR> DO SHOW TIME
RTR> DO SHOW LOGICAL MYLOGICAL
```

Use the `SET ENVIRONMENT` command if a series of DCL commands are to be issued on the same nodes.

4. RTR> DO/NODE=(TR2,TR1) "ps"

This command displays the processes running on Tru64 UNIX nodes TR2 and TR1.

DUMP JOURNAL

DUMP JOURNAL

The **DUMP JOURNAL** command displays information from the current RTR journal.

Format

DUMP JOURNAL

Command Qualifiers	Defaults
/BEFORE[=date]	Today
/COMMIT_SEQUENCE_NUMBER =csn	all CSNs
/FACILITY[=facility-name]	/FACILITY=""
/FINAL_STATE=final-state	None
/FULL	/NOFULL
/LOCK	/NOLOCK
/MESSAGE_NUMBER=msg_nbr	All messages
/NODE[=node-list]	/NODE=default-node
/OUTPUT[=filespec]	/OUTPUT=stdout
/PARTITION=partition	None
/RAW_DATA=filename	None
/RECORD_CLASS=record-class-type	None
/SINCE[=date]	Today
/STATISTICS	None
/TID=tid	All TIDs
/USER=username	All users

Description

The **DUMP JOURNAL** command dumps (that is, displays or sends to a file) the contents of an RTR journal file.

The command can display transaction messages that were written in text format, up to 256 bytes.

Qualifiers

/BEFORE[=date]

Selects only those transactions whose timestamp is before the specified date. Default is the current date.

/COMMIT_SEQUENCE_NUMBER=CSNs

The Commit Sequence Number (CSN) is used in the RTR mechanism controlling transaction sequencing across multiple servers. The CSNs for transactions are displayed by the DUMP JOURNAL command. When this qualifier is used, only those transactions that have the specified CSN number are selected.

/FACILITY[=facility-name]

all facilities (D)

Selects only those transactions belonging to the specified facility. Facility-name can contain wildcards (*, % and ?), in which case all matching facilities are displayed.

If /FACILITY is not specified, journal information for all facilities is displayed.

/FINAL_STATE=final_state

Selects transactions whose final state matches that specified. Final state can be one of:

- VOTED
- COMMIT
- ABORT
- SEND
- EXCEPTION
- PREPARE
- PRI_DONE
- PRI_FORGET
- PRI_START
- PARTITION
- SEC_DONE
- DONE

/FULL

/NOFULL (D)

Specifies that the command dumps detailed information (in logged sequence) about each journal record including the record header and each individual state of the transaction. At the end, the command also dumps the final state of each transaction followed by statistics.

If /FULL is not specified, only brief information is displayed.

/LOCK

/NOLOCK (D)

Lock the journal while dumping it. Locking the journal ensures that the data displayed is accurate and up-to-date; the contents of the journal cannot change while the DUMP JOURNAL command is executing.

DUMP JOURNAL

Locking the journal may interfere with RTR during a standby recovery operation if a standby node tries to acquire the journal lock while the dump is in progress. If this occurs, the standby failover operation is delayed until the DUMP JOURNAL command completes and the standby node can acquire the lock.

/MESSAGE_NUMBER=message_number

This qualifier is only valid when used in conjunction with the /TID and /RAW_DATA qualifiers. Message data is not output unless a raw data file has been specified. Message_number can contain wildcards (*, % and ?), in which case all matching facilities are displayed.

For each selected transaction, message data for each specified message is collected and output to the file specified by the /RAW_DATA qualifier.

If no message is specified, the default is that all messages for each qualifying transaction are selected.

/NODE[=node-list]

/NODE=default-node (D)

Specifies that the command is executed on all nodes specified in node-list. If node-list is omitted, the command is executed only on the node where the command was issued.

/OUTPUT[=filespec]

/OUTPUT=stdout (D)

Specifies that the resulting information is written to the file filespec. If /OUTPUT or filespec is omitted, the standard or default output is used.

/PARTITION=partition_name

Selects only those transactions contained in the specified partition.

/RAW_DATA=filename

Writes the unedited content of each selected message for each selected transaction to the specified file. Message data contained in this file is application specific, and is not interpreted in any way by RTR. It is the responsibility of the application programmer to develop any necessary tools for viewing the contents of this file.

This qualifier is valid only when used in conjunction with the /MESSAGE_NUMBER qualifier.

For each message, the raw data file contains a message header, a variable-length string representing the transaction identifier, and finally the message data. The message header is defined in the `rtr.h` include file, and is specified as follows:

```
typedef struct rtr_raw_data_header_t
{
    rtr_uns_32_t message_number;
    rtr_uns_32_t message_length;
    rtr_uns_32_t tid_length;
    rtr_uns_8_t reserved[256];
};
```

Reading of the raw data file can be done as follows:

1. Read the header (`sizeof rtr_raw_data_header_t`).
2. Read the transaction identifier (`tid_length` bytes) followed by reading the message data (`message_length` bytes), which positions the file offset to the beginning of the next record, *or*
3. Read the rest of the record by reading in `tid_length + message_length` bytes, which again positions the file offset to the beginning of the next record, *or*
4. Skip this message and position directly (`lseek`) to the header of the next message at current offset + `tid_length + message_length` bytes.

/RECORD_CLASS=record_class_type

Selects transactions which match the specified journal-record-class type.

`record_class_type` may be one of the following:

```
VOTED
COMMIT
ABORT
INFO
SEND
EXCEPTION
PREPARE
PRI_DONE
PRI_FORGET
PRI_START
PARTITION
SEC_DONE
DONE
```

DUMP JOURNAL

/SINCE[=date]

Selects only those transactions whose timestamp is after the specified date. Default is the current date.

/STATISTICS

Displays a brief summary of the journal contents, and the number of transactions that may be used for restart and shadow recovery.

/TID=tid

All TIDs (D)

Specifies that the command displays only the information pertaining to this particular transaction ID (tid). tid is the seven-field numeric identifier used by RTR to uniquely identify a transaction.

```
DUMP JOURNAL /TID ="3bd01f10,0,0,0,0,1f4c,2d740001"
```

The quotes enclosing the tid are required. Substituting an asterisk for any one or more of the seven numeric components is permitted as wildcard selection.

If /TID is not specified, log information for all TIDs is displayed.

/USER[=user-id]

/all users (D)

Specifies that the command displays only the information transactions initiated by this particular user-id. User-id may contain wildcards (*, %, and ?), in which case all matching user IDs will be displayed.

If /USER is not specified, log information for all users is displayed.

Related commands

- CREATE JOURNAL
- DELETE JOURNAL
- SHOW JOURNAL
- MONITOR JOURNAL

Examples

The following examples show brief and full output of the DUMP JOURNAL command.

Example 9–1 DUMP JOURNAL Brief Output

```
RTR>DUMP JOURNAL
%RTR-W-JOUINUSE, journal is locked by another user
```

Final Tx States

```
=====
```

```
TX #1
  facility name = test facility
  txid         = 3bd0f10,0,0,0,0,1f4c,2d740001
  partition names = test_partition
  tx start      = Mon Oct 14 20:52:54 2002
  fe user       = user.28924
  final tx state = rtr_tx_jnl_sending
  number of engs = 1
  num of records = 3
  commit_seq_nr = 1
```

Journal Record Statistics

```
=====
```

```
total records processed = 3
  send      = 1
  prepare   = 0
  prepared  = 0
  vote      = 1
  commit    = 0
  abort     = 0
  pri_done  = 0
  sec_done  = 0
  pri_forget = 0
  sec_down  = 0
  pri_start = 0
  dtx_info  = 0
  partition = 0
  exception = 1
  deferred  = 0
  others    = 0

restart recovery txns = 0
shadow recovery txns = 0
```

DUMP JOURNAL

Example 9-2 DUMP JOURNAL Full Output

RTR> DUMP JOURNAL/FULL

%RTR-W-JOUINUSE, journal is locked by another user

```
Record #1                      Entry (1,507918)
Facility name   = test
Record class    = partition
Record version  = 30210304
Partition name  = p_test
Key range ID   = 16777216 (0x1000000)
No. of Segments = 1
Low bound(s)   = 0
High bound(s)  = 4294967295
Segment Number Offset Length Type
                1      0      4 unsigned longword
```

```
Record #2                      Entry (2,508441)
Facility name   = test
Txid            = bb802010,0,0,0,0,bb802010,c0d90944
Tx start        = Fri Jan 25 11:11:35 2002
FE user name    = user1.30557
Partition name  = p_test
Record class    = send
Record version  = 30210304
PJR address     = (1,507918)
Record state:
  kr_id         = 16777216          first_kr_enq   = 1
  enq_nr        = 1                buflen         = 10
```

Message:

```
Offset Bytes          Text
000000 6D 65 73 73 61 67 65 20 31 00  message 1.
```

```
Record #3                      Entry (2,508441)
Facility name   = test
Txid            = bb802010,0,0,0,0,bb802010,c0d90944
Tx start        = Fri Jan 25 11:11:35 2002
FE user name    = user1.30557
Partition name  = p_test
Record class    = send
Record version  = 30210304
PJR address     = (1,507918)
Record state:
  kr_id         = 16777216          first_kr_enq   = 1
  enq_nr        = 2                buflen         = 10
```

Message:

```
Offset Bytes          Text
000000 6D 65 73 73 61 67 65 20 32 00  message 2.
```

(continued on next page)

Example 9–2 (Cont.) DUMP JOURNAL Full Output

Final Tx States

=====

```
TX #1
  facility name = test
  txid          = bb802010,0,0,0,0,bb802010,c0d90944
  partition names = p_test
  tx start      = Fri Jan 25 11:11:35 2002
  fe user       = user1.30557
  final tx state = rtr_tx_jnl_sending
  number of engs = 2
  num of records = 2
  commit_seq_nr = 0
```

Journal Record Statistics

=====

```
total records processed = 3
  send                  = 2
  prepare               = 0
  prepared              = 0
  vote                  = 0
  commit                = 0
  abort                 = 0
  pri_done              = 0
  sec_done              = 0
  pri_forget           = 0
  sec_down              = 0
  pri_start             = 0
  dtx_info              = 0
  partition             = 1
  exception             = 0
  deferred              = 0
  others                = 0

restart recovery txns  = 0
shadow recovery txns   = 0
```

EXECUTE

EXECUTE

The **EXECUTE** command executes a file containing RTR commands.

Format

```
EXECUTE filespec
```

Command Qualifiers	Defaults
/VERIFY	/NOVERIFY

Description

The **EXECUTE** command reads a file containing RTR commands and executes them. This command also has the form @filespec.

Parameters

filespec

Specifies the name of the file containing commands to be executed.

Qualifiers

/VERIFY

/NOVERIFY (D)

Specifies that the commands being executed and the resulting information is displayed on the terminal.

Examples

```
RTR> execute facility_startup
```

This command executes the file `facility_startup`. This file might contain commands such as:

```
start rtr
create journal
create facility funding/fontend=(node1,node2)/router=(node3)...
```

EXIT

The **EXIT** command exits from the RTR prompt.

Note

This command is not available in the RTR web browser interface.

Format

EXIT

Description

The **EXIT** command exits from the RTR prompt and returns control to the operating system prompt. The command has no parameters or qualifiers. Same as **QUIT**.

EXPORT COUNTERS

EXPORT COUNTERS

The **EXPORT COUNTERS** command extracts RTR counter values and optionally captures them in a file for later analysis.

Note

This command is not available in the RTR web browser interface.

Format

```
EXPORT COUNTERS counter-file-spec
```

Command Qualifiers

```
/COUNT  
/INTERVAL  
/NODE[=node-list]  
/OUTPUT[=filespec]
```

Defaults

```
/COUNT=1  
/INTERVAL=1  
/NODE=default-node  
/OUTPUT=stdout
```

Description

The **EXPORT COUNTERS** command samples and displays the values of counters defined in the specified file.

Qualifiers

/COUNT=n

/COUNT=1 (D)

Defines the number of times to repeat the operation.

/INTERVAL=n

/INTERVAL=1 (D)

Defines the interval in seconds between repeats (if any).

/NODE[=node-list]

/NODE=default-node (D)

Specifies that the command is executed on all nodes specified in *node-list*. If *node-list* is omitted, the command is executed only on the node where the command was issued.

/OUTPUT[=filespec]

/OUTPUT=stdout (D)

Specifies that the resulting information is written to the file filespec. If /OUTPUT or filespec is omitted, the standard or default output is used.

Examples

```
RTR> EXPORT COUNTERS PerfCtrA.ctr/OUTPUT=CountersNodeA
```

This command tells RTR to write a file of counters called CountersNodeA using the performance counters defined in the file PerfCtrA.ctr.

EXTEND FACILITY

EXTEND FACILITY

The **EXTEND FACILITY** command adds new nodes or roles (or both) to an existing facility definition.

Format

```
EXTEND FACILITY [facility_name]
```

Command Qualifiers

```
/ALL_ROLES=nodelist  
/BACKEND=backend-list  
/BALANCE  
/CALL_OUT=role-list  
/CLUSTER  
/FRONTEND=frontend-list  
/NODE[=node-list]  
/OUTPUT[=filespec]  
/ROUTER=router-list
```

Defaults

```
/NOALL_ROLES  
/NOBACKEND  
/NOBALANCE  
None  
/NOCLUSTER  
/NOFRONTEND  
/NODE=default-node  
/OUTPUT=stdout  
/NOROUTER
```

Description

The **EXTEND FACILITY** command extends the configuration of an RTR facility. New nodes and roles can be added to a facility definition using the **EXTEND FACILITY** command. Thus a new node can be introduced into a facility, or a new role can be added to an existing node (for example, a router node can be extended to have a backend role).

Defining Nodes and Roles in Each Facility

For a new router node, define *all* its backend nodes.

For a new backend node, define *all* its router nodes.

For a new router node, define only those frontends to which it will connect.

For a new frontend node, define only those routers to which it will connect.

Multiple **EXTEND FACILITY** commands are additive; that is, a second **EXTEND FACILITY** command does not supersede a previous command or remove roles, it only adds them.

For use of anonymous clients (wildcards), see the `CREATE FACILITY` command.

When using this command, the facility being extended may temporarily lose quorum until the affected nodes agree upon the new facility definition. During this time, server applications will not be presented with any new transactions.

The `RTR MONITOR QUORUM` displays a monitor picture which allows the quorum negotiations to be followed after a `TRIM` or `EXTEND` of a facility. Once quorum has been attained, the participating nodes return to state `qtr`.

As with the `CREATE FACILITY` command, superfluous nodes or roles can be specified. That is, you may specify backend nodes on a node that has only a frontend role, and frontend nodes may be specified on a node that has only a backend role. This permits a single `RTR` management command to be issued on many nodes, and each node accepts only those parts of the command which are relevant to it.

For example, in a two-node facility called `facnam`, the node `FE` has the frontend role only. Node `FETRBE`, which has frontend, router and backend roles, can be created as follows:

```
$ RTR
RTR> SET ENVIRONMENT /NODE=(FE,FETRBE)
RTR> CREATE FACILITY facnam /FRONTEND=(FE,FETRBE) -
      /ROUTER=FETRBE -
      /BACKEND=FETRBE
```

A new frontend `NFE` can be added to this facility as follows:

```
$ RTR
RTR> SET ENVIRONMENT /NODE=(FETRBE,NFE)
RTR> EXTEND FACILITY facnam /FRONTEND=NFE -
      /ROUTER=FETRBE
```

Parameters

facility_name

Specifies the name of the facility to be extended.

Any application program that uses this facility must specify the same name when it calls the `rtr_open_channel`.

Facility names can contain up to 31 characters. Letters, numbers and underline characters are all valid, but the first character of a facility name must be a letter.

The default value for `facility_name` is `RTR$DEFAULT_FACILITY`.

EXTEND FACILITY

The `/ROUTER` qualifier, and at least one `/FRONTEND` or `/BACKEND` qualifier must be specified.

An `EXTEND FACILITY` command executed on a node where the facility is not defined is interpreted as a `CREATE FACILITY` command.

To maintain consistency in a facility, the following rules apply when adding nodes or roles or both:

- If a frontend role is added, the node where it is added must know about at least one router of the facility.
- If a backend role is added, the node where it is added must know about all routers of the facility. If any router nodes are not known by a backend, problems can occur in achieving quorum.
- If a router role is added, the node upon which it is added must know about all backends of the facility. If not all backend nodes are known by a router, problems will occur in achieving quorum. At least one frontend must be defined on a node that has the router role.
- To have a consistent facility definition across all nodes in the facility (and thus avoid problems in attaining quorum), the command to add a router role must be executed on all relevant nodes, that is, the node gaining the router role and all backend nodes.

Qualifiers

`/ALL_ROLES=node-list`

`/NOALL_ROLES (D)`

Specifies the names of the nodes that are to act as frontend, router and backend in this facility.

Note that the definition order of nodes may be significant. This applies to the order of router node definitions when frontend load balancing is not enabled. Nodes defined with the `/ROUTER` qualifier have the higher priority and are followed by nodes defined by the `/ALL_ROLES` qualifier. For example, in this definition:

```
$ RTR CREATE FACILITY /ALL_ROLES=mynode /ROUTER=(anode,bnode)
```

The router nodes are in definition order `anode`, `bnode`, `mynode` for all frontends except `mynode`. (Any node that has both frontend and router roles selects its own router first.)

/BACKEND=backend-list

/NOBACKEND (D)

Specifies the names of the added nodes that are to act as backends for this facility.

Backend-list is a list of backend-nodes separated by commas. If there is more than one backend-node, backend-list must be enclosed in parentheses.

Backend-node is either the name of a node or @filespec, where filespec specifies a file containing a backend-list on each line.

/BALANCE

/NOBALANCE (D)

Specifies that load balancing is enabled for frontend/router connections across the facility.

For load balancing to function correctly, /BALANCE must be defined on *all* routers, as well as on those frontends requiring load balancing.

It has no significance on a backend node, and will be ignored if specified.

The default behavior (/NOBALANCE) is for a frontend to connect to the *preferred router*. Preferred routers are defined by the order specified in the /ROUTER qualifier of the EXTEND FACILITY command. Note that this preference is subject to the router being available and quorate.

For more details on frontend load balancing, see Section 2.8, Router Load Balancing.

/CALL_OUT[=role-list]

/NOCALL_OUT

Specifies which node types are to have callout servers running on them. There is no default.

Role-list is a comma-separated list of roles. If role-list contains more than one role, it must be enclosed in parentheses.

Role is one of the keywords ROUTER or BACKEND.

The default for role-list is (ROUTER, BACKEND).

/NOCALL_OUT removes the existing callout servers associated with the facility. If a facility has callout servers, an EXTEND FACILITY command without /CALL_OUT or /NOCALL_OUT qualifiers keeps its callout servers.

/CLUSTER

/NOCLUSTER (D)

Specifies that the command is executed on all the nodes in the cluster.

EXTEND FACILITY

If neither `/NODE` nor `/CLUSTER` is specified, the command is executed on the nodes specified by the latest `SET ENVIRONMENT` command. If no `SET ENVIRONMENT` command has been entered, the command is executed only on the node where the command was issued.

Note

In environments that do not support remote command capability, the `/CLUSTER` qualifier causes the relevant command to be executed on the local node only.

`/FRONTEND=frontend-list`

`/NOFRONTEND (D)`

Specifies the names of the added nodes that act as frontends in this facility. `Frontend-list` is a list of `frontend-nodes` separated by commas. If there is more than one `frontend-node`, `frontend-list` must be enclosed in parentheses.

`Frontend-node` is either the name of a node or `@filespec`, where `filespec` specifies a text file containing a `frontend-list` on each line.

`/NODE[=node-list]`

`/NODE=default-node (D)`

Specifies that the command is executed on all nodes specified in `node-list`. If `node-list` is omitted, the command is executed only on the node where the command was issued.

`/OUTPUT[=filespec]`

`/OUTPUT=stdout (D)`

Specifies that the resulting information is written to the file `filespec`. If `/OUTPUT` or `filespec` is omitted, the standard or default output is used.

`/ROUTER=router-list`

`/NOROUTER (D)`

Specifies the names of the added nodes that act as routers for this facility.

`Router-list` is a list of `router-nodes` separated by commas. If there is more than one `router-node`, `router-list` must be enclosed in parentheses.

If `/NOBALANCE` is specified with the `EXTEND FACILITY` command, the order in which router nodes are specified with the `/ROUTER` qualifier defines the preferred routing order.

`Router-node` is either the name of a node or `@filespec`.

filespec specifies a text file containing a router-list on each line.

Related commands

- CREATE FACILITY
- DELETE FACILITY
- SHOW FACILITY
- TRIM FACILITY

Examples

See Chapter 2, Starting and Setting Up RTR, for examples of how to use the EXTEND FACILITY command.

FLUSH NAME_CACHE

FLUSH NAME_CACHE

The **FLUSH NAME_CACHE** command flushes RTR's internal network name cache.

Note

This command is not available in the RTR web browser interface.

Format

FLUSH NAME_CACHE

Command Qualifiers

/CLUSTER

/NODE[=node-list]

Defaults

/NOCLUSTER

/NODE=default-node

Description

The **FLUSH NAME_CACHE** command removes information for all known nodes from RTR's internal network name cache.

Network links could become unstable if a Distributed Name Service (DNS) was configured improperly or the service was slow in responding. During extreme DNS latency, RTR could timeout the connections to nodes waiting for a DNS response. To avoid these problems, RTR has implemented an internal node-name-to-id cache; this reduces RTR's exposure to degraded name servers. The contents of the cache can then be deleted using the command **FLUSH NAME_CACHE**.

FLUSH NAME_CACHE can be used if the network has been reconfigured or nodes have changed their addresses.

Qualifiers

/CLUSTER

/NOCLUSTER (D)

Specifies that the command is executed on all the nodes in the cluster.

If neither `/NODE` nor `/CLUSTER` is specified, the command is executed on the nodes specified by the latest `SET ENVIRONMENT` command. If no `SET ENVIRONMENT` command has been entered, the command is executed only on the node where the command was issued.

Note

In environments that do not support remote command capability, the `/CLUSTER` qualifier causes the relevant command to be executed on the local node only.

`/NODE[=node-list]`

`/NODE=default-node (D)`

Specifies that the command is executed on all nodes specified in `node-list`. If `node-list` is omitted, the command is executed only on the node where the command was issued.

INITIALIZE JOURNAL

INITIALIZE JOURNAL

See CREATE JOURNAL; INITIALIZE is only retained for compatibility reasons.

LOG

The **LOG** command enters a message in a log file.

Note

This command is not available in the RTR web browser interface.

Format

LOG

Command Qualifiers

/CLUSTER
/NODE[=node-list]
/OUTPUT[=filespec]

Defaults

/NOCLUSTER
/NODE=default-node
/OUTPUT=stdout

Description

The LOG command lets you enter text that is written to the current log file. You can write log messages to the operator console or to a log file, but not both simultaneously.

To view which is the current log file, use the SHOW LOG command. To view the contents of the log file, use an editor such as Edt, Notepad, or vi, depending on your operating system. The log file is an ASCII text file. To establish which is the log file, use the SET LOG command. Log files must be periodically purged to avoid difficulties with full disks. If neither the /OPERATOR nor the /FILE qualifier is specified, logging is suppressed. Use the SET LOG command to specify a new file and close the old one.

Qualifiers

/CLUSTER
/NOCLUSTER (D)

Specifies that the command is executed on all the nodes in the cluster.

If neither /NODE nor /CLUSTER is specified, the command is executed on the nodes specified by the latest SET ENVIRONMENT command. If no SET ENVIRONMENT command has been entered, the command is executed only on the node where the command was issued.

LOG

Note

In environments that do not support remote command capability, the `/CLUSTER` qualifier causes the relevant command to be executed on the local node only.

/NODE[=node-list]

/NODE=default-node (D)

Specifies that the command is executed on all nodes specified in `node-list`. If `node-list` is omitted, the command is executed only on the node where the command was issued.

/OUTPUT[=filespec]

/OUTPUT=stdout (D)

Specifies that the resulting information is written to the file `filespec`. If `/OUTPUT` or `filespec` is omitted, the standard or default output is used.

Related commands

- SHOW LOG
- SET LOG

Examples

```
RTR> LOG/OUTPUT=RTRLOG.LOG "Message check here"
```

This command tells RTR to write a log message to the file `RTRLOG.LOG`.

```
RTR> LOG/CLUSTER "Check for this message to see if logging is working"
```

This command tells RTR to write log messages to all members of a cluster.

```
RTR> LOG/NODE=hostname "Message check HERE"
```

This command tells RTR to write a defined log message to the log file on the node `hostname`.

For an example of the contents of a log file, see the `SET LOG` command.

MODIFY CONNECTIONPOOL

The **MODIFY CONNECTIONPOOL** command modifies an RTR connection pool that can be used with applications that employ JNDI, the Java Naming and Directory Interface.

Use of this command requires the RTR Java Toolkit.

Format

```
MODIFY CONNECTIONPOOL connectionpool_name
```

Command Qualifiers	Defaults
/CLASSNAME=class_name	None
/CON_CAPACITYINCREMENT=capacity-increment	None
/CON_INITIALCAPACITY=initial-capacity	None
/CON_MAXIMUMCAPACITY=maximum-capacity	None
/DATABASENAME=database_name	None
/DESCRIPTION=description	None
/JNDI_NAME=jndi_name	None
/NETWORKPROTOCOL=net-protocol	None
/NODE[=node-list]	/NODE=default-node
/PASSWORD=password	None
/PORTNUMBER=port-number	None
/PROPERTY=property_list	None
/ROLENAME=role-name	None
/SERVERNAME=server-name	None
/SERVICEPROVIDER_NAME=serviceprovider_name	None
/TEST	None
/USER=user-name	None

Description

The **MODIFY CONNECTIONPOOL** command modifies or changes an RTR connectionpool that is used with JNDI applications.

The command must be issued before any Java application using the specified connectionpool is started.

See the related commands and the RTR Glossary in the *HP Reliable Transaction Router Getting Started* for additional information on this and other Java-related commands.

MODIFY CONNECTIONPOOL

Parameters

connectionpool_name

Specifies the name of the connectionpool to be changed. A *connectionpool_name* must be unique within an RTR ACP process.

The command fails if the *connectionpool_name* does not exist in the RTR ACP process or if the connectionpool has been created and is currently in use.

To modify a connectionpool instance, you must delete all datasources that reference it.

There is no default value for *connectionpool_name*.

Qualifiers

/CLASSNAME

Specifies the class-name that is used in setting up the connection.

/CON_CAPACITYINCREMENT

Specifies the capacity increment of connectionpool as a standard property to set up the connectionpool object.

/CON_INITIALCAPACITY

Specifies the initial capacity of connectionpool as a standard property to set up the connectionpool object.

/CON_MAXIMUMCAPACITY

Specifies the maximum capacity of connectionpool as a standard property to set up the connectionpool object.

/DATABASENAME

Specifies the database-name as a standard property in setting up the connectionpool object.

/DESCRIPTION

Specifies the description as a standard property in setting up the connectionpool object.

/JNDI_NAME

Specifies the jndi-name used to provide Java applications with JNDI services.

/NETWORKPROTOCOL

Specifies the network protocol as a standard property in setting up the connectionpool object.

/NODE[=node-list]

/NODE=default-node(D)

Specifies that the command be executed on all nodes in *node-list*. If *node-list* is omitted, the command is executed only on the local node where the command was issued.

/PASSWORD

Specifies the password as a standard property in setting up the connectionpool object.

/PORTNUMBER

Specifies the port number as a standard property in setting up the connectionpool object.

/ROLENAME

Specifies the role-name as a standard property in setting up the connectionpool object.

/PROPERTY

Specifies the standard/non-standard properties and their values in setting up the connectionpool. The format of the property list is as follows: (key1:value1, key2:value2, . . . <NULL>)

For information on JNDI properties, see CREATE SERVICEPROVIDER and the descriptions on the Java web site

<http://java.sun.com/products/jndi/tutorial/beyond/env/overview.html>

RTR supports the following keys:

- APPLET
- AUTHORITATIVE
- BATCHSIZE
- LANGUAGE
- REFERRAL
- SECURITY_AUTHENTICATION
- SECURITY_CREDENTIALS
- SECURITY_PRINCIPAL
- SECURITY_PROTOCOL

MODIFY CONNECTIONPOOL

/SERVERNAME

Specifies the server-name as a standard property in setting up the connectionpool object.

/SERVICEPROVIDER_NAME

Specifies a defined serviceprovider that this connectionpool may reference.

/TEST

Test the environment property.

/USER

Specifies the user-name as a standard property in setting up the connectionpool object.

Related Commands

- CREATE CONNECTIONPOOL
- CREATE DATASOURCE
- CREATE SERVICEPROVIDER
- DELETE CONNECTIONPOOL
- SHOW CONNECTIONPOOL

Examples

The following example shows use of the MODIFY CONNECTIONPOOL command to add a node to an existing connectionpool called myconnection.

```
RTR> MODIFY CONNECTIONPOOL myconnection/jndi=nodeA
%RTR-S-CPMODIFIED, ConnectionPool myconnection, has been modified
```

MODIFY DATASOURCE

The **MODIFY DATASOURCE** command modifies or changes an RTR datasource used with applications written using JNDI, the Java Naming and Directory Interface.

Use of this command requires the RTR Java Toolkit.

Format

```
MODIFY DATASOURCE  datasource_name
```

Command Qualifiers	Defaults
/JNDI_NAME=jndi_name	None
/NODE[=node-list]	/NODE=default-node
/POOL_NAME=connectionpool_name	None
/SERVICEPROVIDER_NAME=serviceprovider_name	None

Description

The **MODIFY DATASOURCE** command changes an RTR datasource used with a JNDI application.

The command must be issued before any Java application using the datasource is started.

See the related commands and the RTR Glossary in the *HP Reliable Transaction Router Getting Started* for additional information on this and other Java-related commands.

Parameters

datasource_name

Specifies the name of the datasource to be changed. There is no default value for the *datasource_name*.

The command fails if the *datasource_name* does not exist in the RTR ACP process.

Qualifiers

/JNDI_NAME

Specifies the name of the JNDI resource providing Java applications with multiple JNDI services.

MODIFY DATASOURCE

/NODE[=*node-list*]

/NODE=*default-node(D)*

Executes the command on all nodes specified in *node-list*. If *node-list* is omitted, then the command is executed only on the node where the command was issued.

/POOL_NAME

Specifies a defined connectionpool that this datasource may reference.

/SERVICEPROVIDER_NAME

Specifies a defined serviceprovider that this datasource may reference.

Related commands

- CREATE CONNECTIONPOOL
- CREATE DATASOURCE
- CREATE SERVICEPROVIDER
- DELETE DATASOURCE
- SHOW DATASOURCE

Examples

The following example shows use of the MODIFY DATASOURCE command to modify a datasource called mydatasource.

```
RTR> modify data mydatasource /jndi=rtrDS1
%RTR-S-DSMODIFIED, datasource mydatasource has been modified
```

MODIFY JOURNAL

The **MODIFY JOURNAL** command specifies the desired and maximum allowed sizes of RTR's recovery journal.

Format

```
MODIFY JOURNAL [disk-1] ... [,disk-n]
```

Command Qualifiers

```
/CLUSTER
/BLOCKS[=nr-blocks]
/MAXIMUM_BLOCKS[=nr-blocks]
/NODE[=node-list]
/OUTPUT[=filespec]
```

Defaults

```
/NOCLUSTER
/BLOCKS=1000 or current value
/MAXIMUM_BLOCKS=1000 or current value
/NODE=default-node
/OUTPUT=stdout
```

Description

The **MODIFY JOURNAL** command specifies how the size of RTR recovery journal files on the specified disks can be modified. The target or minimum size is specified using the **/BLOCKS** qualifier. The maximum allowed size is specified using the **/MAXIMUM_BLOCKS** qualifier. **/BLOCKS** and **/MAXIMUM_BLOCKS** are positional qualifiers, so journal files need not be the same size on each disk.

RTR only uses journal files on nodes that are configured to run servers, that is, on backends and on routers with callout servers.

Note that the **MODIFY JOURNAL** command does not cause immediate journal file extension. Actual file size modifications take place on demand (by the **RTRACP**) within the limits defined by the **MODIFY JOURNAL** command.

The **MODIFY JOURNAL** command assumes that a journal already exists for the node. If a journal does not exist, an error message is output.

In contrast to the **CREATE JOURNAL** command, the **MODIFY JOURNAL** command is normally entered interactively, not automatically from a startup command procedure.

MODIFY JOURNAL

Parameters

disk-1 ... disk-n

Specifies a list of disk names where journal files are modified.

Refer to the CREATE JOURNAL command for information about disks used for journal files.

Qualifiers

/BLOCKS[=nr-blocks]

/BLOCKS=1000 or *current-value* (D)

Specifies the size of the journal file in blocks. This qualifier can be applied locally to each disk or globally for all disks. If the number of blocks has been specified in a CREATE JOURNAL command, the default is the current value.

/CLUSTER

/NOCLUSTER (D)

Specifies that the command is executed on all the nodes in the cluster.

If neither /NODE nor /CLUSTER is specified, the command is executed on the nodes specified by the latest SET ENVIRONMENT command. If no SET ENVIRONMENT command has been entered, the command is executed only on the node where the command was issued.

Note

In environments that do not support remote command capability, the /CLUSTER qualifier causes the relevant command to be executed on the local node only.

/MAXIMUM_BLOCKS[=nr-blocks]

/MAXIMUM_BLOCKS=1000 or *current-value* (D)

Specifies the maximum size that the journal file can use. This qualifier can be applied locally to each disk or globally for all disks. If the maximum number of blocks has been specified in a CREATE JOURNAL command, the default is the current value.

/NODE[=node-list]

/NODE=default-node (D)

Specifies that the command is executed on all nodes specified in node-list. If node-list is omitted, the command is executed only on the node where the command was issued.

/OUTPUT[=filespec]
/OUTPUT=stdout (D)

Specifies that the resulting information is written to the file filespec. If /OUTPUT or filespec is omitted, the standard or default output is used.

Related commands

- CREATE JOURNAL
- INITIALIZE JOURNAL
- SHOW JOURNAL

Example

```
RTR> MODIFY JOURNAL "/dev/rz3a" /BLOCK=2000 /MAXIMUM_BLOCKS=20000
```

This command specifies that the desired size of the journal file is 2000 blocks, and the maximum journal file size is 20,000 blocks.

OpenVMS example

```
RTR> MODIFY JOURNAL DISK1$:/BLOCKS=3000/MAXIMUM_BLOCKS=20000
```

This command specifies that the desired size of the journal file is 3000 blocks, and the maximum journal file size is 20,000 blocks.

MODIFY SERVICEPROVIDER

MODIFY SERVICEPROVIDER

The **MODIFY SERVICEPROVIDER** command modifies or changes an RTR serviceprovider used with applications written using JNDI, the Java Naming and Directory Interface.

Use of this command requires the RTR Java Toolkit.

Format

```
MODIFY SERVICEPROVIDER serviceprovider_name
```

Command Qualifiers

/DNS_URL=dns_url-name

/INITIAL_CONTEXT_FACTORY= initial_context_factory-name

/NODE[=node-list]

/OBJECT_FACTORIES=object_factories-name

/PROPERTY=property_list

/PROVIDER_URL=provider_url-name

/TEST

/URL_PKG_PREFIXES=url_pkg_prefixes-name

Defaults

None

None

/NODE=default-node

None

None

None

None

None

Description

The **MODIFY SERVICEPROVIDER** command modifies or changes an RTR serviceprovider used with a JNDI application.

The command must be issued before any Java application using the changed serviceprovider is started.

See the related commands and the RTR Glossary in the *HP Reliable Transaction Router Getting Started* for additional information on this and other Java-related commands.

Parameters

serviceprovider_name

Specifies the name of the serviceprovider to be changed.

The command fails if the *serviceprovider_name* does not exist in the RTR ACP process or if the serviceprovider has been created and is currently in use. To modify a serviceprovider instance, you must delete all connectionpools and datasources that reference it.

There is no default value for *serviceprovider_name*.

Qualifiers

/DNS_URL

Specifies a constant containing the name of the environment property giving the DNS host and domain names to use for the JNDI URL context (for example, "dns://somehost/wiz.com").

/INITIAL_CONTEXT_FACTORY

Specifies a constant containing the class name of the environment property that specifies the initial context factory.

/NODE[=node-list]

/NODE=default-node(D)

Execute the command on all nodes specified in *node-list*. If *node-list* is omitted, then the command is executed only on the local node where the command was issued.

/OBJECT_FACTORIES

Specifies a constant containing the name of the environment property that specifies the colon-separated list of object-factory class names.

/PROPERTY

Specifies keys and values for the remaining environment property names. The format of the property list is (key1:value1,key2:value2, . . . <NULL>).

RTR supports the following keys:

- APPLET
- AUTHORITATIVE
- BATCHSIZE
- LANGUAGE
- REFERRAL
- SECURITY_AUTHENTICATION
- SECURITY_CREDENTIALS
- SECURITY_PRINCIPAL
- SECURITY_PROTOCOL

For information on these JNDI environment properties, see the descriptions on the Java web site

<http://java.sun.com/products/jndi/tutorial/beyond/env/overview.html>

MODIFY SERVICEPROVIDER

/PROVIDER_URL

Specifies a constant containing the name of the environment property that specifies a URL string for configuring the service provider specified by the INITIAL_CONTEXT_FACTORY property.

/TEST

Test the environment property.

/URL_PKG_PREFIXES

Specifies a constant containing the name of the environment property that specifies the colon-separated list of package prefixes to use when loading URL-context factories.

Related commands

- CREATE CONNECTIONPOOL
- CREATE DATASOURCE
- DELETE SERVICEPROVIDER
- MODIFY CONNECTIONPOOL
- MODIFY DATASOURCE
- SHOW CONNECTIONPOOL
- SHOW DATASOURCE
- SHOW SERVICEPROVIDER

Examples

The following example shows use of the MODIFY SERVICEPROVIDER command. command sets the provider URL used by the serviceprovider.

```
RTR> MODIFY SERVICEPROVIDER myservice /PROVIDER_URL="file:c:\\java_jndi"  
%RTR-S-SPMODIFIED, ServiceProvider myservice has been modified
```

MONITOR

The **MONITOR** command displays a monitor picture on the screen.

Format

MONITOR [monitor-filespec]

Command Qualifiers	Defaults
/CLUSTER	/NOCLUSTER
/COUNT=nr-updates	/COUNT=infinite
/FACILITY=facility-name	/NOFACILITY
/IDENTIFICATION=process-id	/NOIDENTIFICATION
/INTERVAL=delay-seconds	/INTERVAL=2
/LINK=link-name	/NOLINK
/NODE[=node-list]	/NODE=default-node
/OUTPUT[=filespec]	/OUTPUT=stdout
/PARTITION=partition-name	/NOPARTITION
/RESUME	/NORESUME

Description

The **MONITOR** command allows certain RTR status variables to be continuously displayed on your terminal.

The individual items displayed in the monitor picture can be defined interactively using **DISPLAY** commands and then executed using a **MONITOR/RESUME** command.

You can also put the **DISPLAY** commands into a file (called a monitor file) and then issue a **MONITOR monitor-filespec** command.

See Chapter 8 for a description of standard monitor pictures.

Parameters

monitor-filespec

Specifies a file containing **DISPLAY** commands. Monitor file names are of the form **monitor-filespec.mon**

This file can specify either a user-defined display or one of the standard displays supplied with RTR. If **monitor-filespec** contains only the file-name portion of a file specification, the RTR utility first searches the platform-specific location for a standard monitor file.

MONITOR

Qualifiers

/CLUSTER

/NOCLUSTER (D)

Specifies that the command is executed on all the nodes in the cluster.

If neither **/NODE** nor **/CLUSTER** is specified, the command is executed on the nodes specified by the latest **SET ENVIRONMENT** command. If no **SET ENVIRONMENT** command has been entered, the command is executed only on the node where the command was issued.

Note

In environments that do not support remote command capability, the **/CLUSTER** qualifier causes the relevant command to be executed on the local node only.

/COUNT=nr-updates

/COUNT=infinite (D)

Specifies how many times the RTR utility updates the screen before exiting or returning to the **RTR>** prompt.

The default is that RTR updates the screen until **CTRL-Z**, **CTRL-Y** or another RTR command is entered. Use the **/COUNT** qualifier when the **/OUTPUT** qualifier is being used to redirect output to a file. In this case, **nr-updates** specifies how many screen images are written to the file.

/FACILITY=facility-name

/NOFACILITY (D)

Specifies the name of the facility to be monitored. This is only meaningful if at least one facility counter is displayed.

/IDENTIFICATION=process-id

/NOIDENTIFICATION (D)

Specifies the process-id of the process to be monitored. This is only meaningful if at least one process counter is to be displayed.

/INTERVAL[=delay-seconds]

/INTERVAL=2 (D)

Specifies how frequently RTR updates the screen. **Delay-seconds** is the number of seconds that RTR waits after completing one screen update before starting the next. Note that the interval between updates will always be

slightly longer than Delay-seconds, depending on the complexity of the display and the number of nodes being monitored.

/LINK=link-name

/NOLINK (D)

Specifies the node name for the link to be monitored. This is only meaningful if at least one link counter is to be displayed.

A link-name can include a wildcard. For example, /LINK=(a*) displays the relevant data for links whose name start with the letter a.

/NODE[=node-list]

/NODE=default-node (D)

Specifies that the command is executed on all nodes specified in node-list. If node-list is omitted, the command is executed only on the node where the command was issued.

/OUTPUT[=filespec]

/OUTPUT=stdout (D)

Specifies that the resulting information is written to the file filespec. If /OUTPUT or filespec is omitted, the standard or default output is used.

/PARTITION=partition-name

/NOPARTITION (D)

Specifies the names of the partitions to be monitored. This is only meaningful if at least one partition counter is to be displayed.

/RESUME

/NORESUME (D)

Re-executes the last MONITOR command. The qualifiers /OUTPUT, /INTERVAL and /COUNT may be used with /RESUME. All other qualifiers are ignored. Use this qualifier to reset all the averages currently being displayed. It is also useful if monitoring is resumed after issuing one or more RTR commands.

Related commands

- CLEAR
- DISPLAY BAR
- DISPLAY NUMERIC
- DISPLAY TEXT

MONITOR

- REMEMBER EXPRESSION
- SCROLL

You can use the following keystrokes when a monitor picture is active:

Keystroke	Meaning
<CTRL>/W	Refresh
<CTRL>/P	Print to file
Q	Quit
q	Quit

Examples

```
RTR> MONITOR CALLS/NODE=(TR2,TR1)/INTERVAL=10 ❶  
RTR> SHOW PROCESS ❷  
RTR> MONITOR/RESUME ❸
```

- ❶ Display the CALLS picture, monitoring nodes TR2 and TR1 every 10 seconds.
- ❷ The SHOW PROCESS command is entered, interrupting the display.
- ❸ Redisplay the CALLS picture using the original parameters.

```
RTR> MONITOR TRAFFIC/COUNT=10/OUTPUT=PICTURE.LIS
```

This command stores 10 images of the TRAFFIC picture in the file PICTURE.LIS.

```
RTR> MONITOR LRC/LINK=*a*/NODE=spica  
RTR> mon lrc/link=*a*/node=spica
```

```
LINK CHECKSUM ERRORS Sun Jul 4 2004 14:11:23 spica <- *a*  
Links up 3 Links down 0 Total links 3 All required links up  
enabled lrcerror lrcheader lrctrailer lrcundone received  
Total 0 0 0 0 191 192  
spica <- spica 0 0 0 0 0 1  
spica <- acruX 0 0 0 0 95 95  
spica <- vega 0 0 0 0 96 96
```

This example displays links containing the letter a.

QUIT

The **QUIT** command quits from the RTR prompt.

Note

This command is not available in the RTR web browser interface.

Format

QUIT

Description

The **QUIT** command exits from the RTR prompt and returns control to the operating system prompt. The command has no parameters or qualifiers. Same as **EXIT**.

RECALL

RECALL

The **RECALL** command displays a previously entered command for subsequent command editing.

Note

This command is not available in the RTR web browser interface.

Format

RECALL [command-specifier]

Command Qualifiers

/ALL

Defaults

/NOALL

Description

When you enter commands to the RTR Utility, they are stored in a recall buffer for later use with the **RECALL** command. Commands can be recalled by either entering the first few characters of the command or the command's number. Use the **RECALL/ALL** command to list the last 50 commands.

When you recall a command, the RTR Utility displays the command but does not execute it. To execute the command as it appears, press **RETURN**. You can also use the command editing facility to make changes in the command line and then press **RETURN** to process the revised version of the command.

Parameters

command-specifier

Specifies either the command number or the first few characters of the command you want to recall.

If **command-specifier** is omitted, the most recently entered command is recalled.

Qualifiers

/ALL

/NOALL (D)

Displays all the commands (and their numbers) available for recall.

Examples

```
RTR> CREATE FACILITY QUOTES/FRONT=FE3/ROUTER=TR2 ❶  
RTR> SHOW FACILITY/LINK ❷  
RTR> RECALL CREATE ❸  
RTR> CREATE FACILITY QUOTES/FRONT=FE3/ROUTER=TR2  
RTR> CREATE FACILITY ORDERS/FRONT=FE3/ROUTER=TR2 ❹
```

- ❶ Create facility QUOTES.
- ❷ Check the links.
- ❸ Recall the CREATE FACILITY command.
- ❹ Change the facility name to ORDERS and resubmit the command.

REGISTER RESOURCE_MANAGER (REGISTER RM)

REGISTER RESOURCE_MANAGER (REGISTER RM)

The **REGISTER RESOURCE_MANAGER** command registers an instance of a resource manager (RM) with RTR.

Format

```
REGISTER RESOURCE_MANAGER [resource_name]
```

```
REGISTER RM [resource_name]
```

Command Qualifiers	Defaults
/OPEN_STRING=open_string	None
/CLOSE_STRING=close_string	None
/LIBRARY_PATH=library_path	None
/XASWITCH_NAME=switch_name	None

Description

The REGISTER RESOURCE_MANAGER command registers multiple resource managers or instances of resource managers (up to 16) with the current transaction manager. A different resource manager (RM) instance name is needed for each referenced database. Use this command after the RTR ACP is started and before the RTR facilities associated with this resource manager are created. Each RM can be associated with only one facility, but one facility can be associated with multiple RMs.

Refer to Appendix C, RTR XA Support for support information about XA.

Note

This command is available only on UNIX and Windows systems.

Parameters

resource_name

Specifies the name of the resource to be registered.

Any application program using this resource must specify the same name when it calls `rtr_open_channel()`.

REGISTER RESOURCE_MANAGER (REGISTER RM)

Resource names can contain up to 30 characters. Letters, numbers and underline characters are all valid, but the first character of a resource name must be a letter.

The default value for `resource_name` is `RTR$DEFAULT_RESOURCE`.

Qualifiers

/OPEN_STRING=open_string

RTR uses the `OPEN_STRING` qualifier to open a connection to the underlying resource manager. `open_string` is a null-terminated character string that may contain instance-specific information for the resource manager. The maximum length of the string is 256 bytes (including the null terminator). You must consult the resource manager system administrator to get the appropriate open string.

If this qualifier is not specified, RTR uses a null open string to open the resource manager.

/CLOSE_STRING=close_string

RTR uses the `CLOSE_STRING` qualifiers to close a connection to a resource manager. `close_string` is a null-terminated character string with a maximum length of 256 bytes (including the null terminator). If the resource manager does not require a close string to close the connection to the resource manager, you do not need to use this qualifier. You must consult the resource manager's system administrator documentation to get the appropriate close string.

/LIBRARY_PATH=library_path

Specifies the path and name of the XA library provided by the resource manager. RTR uses the pathname to load the XA library and resolve symbols at runtime.

This qualifier is required.

/XASWITCH_NAME=switch-name

Specifies an XA switch structure name that RTR uses to resolve symbols when it loads an XA library. Each resource manager is required to provide an XA switch and publish the switch structure name so that a transaction manager such as RTR can gain access to the RM's XA routines. You must consult the resource manager's system administrator documentation to get the proper switch name.

REGISTER RESOURCE_MANAGER (REGISTER RM)

This qualifier is required.

Note

Resource manager-related information such as open string, close string and the switch name are very vendor-specific. Each resource manager may have a different requirement for accessing the XA library. The resource manager vendor is required to publicize all the specific information and restrictions. You should read their documentation about XA libraries thoroughly before using it.

Related commands

- UNREGISTER RESOURCE_MANAGER
- SHOW RESOURCE_MANAGER

Examples

```
RTR> REGISTER RM rmi_1 -  
  _RTR> /open_string="Oracle_XA+Acc=P -  
  _RTR> /user/pw+SesTm=15+db=accounting" -  
  _RTR> /close_string="" /xaswitch_name=xaosw -  
  _RTR> /library_path="library_path"
```

REMEMBER EXPRESSION

The **REMEMBER EXPRESSION** command adds rules to be evaluated when nodes are performing internal problem detection.

Format

REMEMBER EXPRESSION [expression_name]

Command Qualifiers	Defaults
/ERROR=Boolean-expression	/ERROR=1
/FATAL=Boolean-expression	/FATAL=1
/MGERROR="text-string"	/MGERROR="Please provide an error message"
/MGFATAL="text-string"	/MGFATAL="Please provide a fatal message"
/MGWARN="text-string"	/MGWARN="Please provide a warning message"
/WARNING=Boolean-expression	/WARNING=1

Description

The **REMEMBER EXPRESSION** command remembers a rule that is evaluated when nodes perform internal problem detection. If a node is to evaluate the expression for each internal problem-detection cycle, place the **REMEMBER EXPRESSION** command in the monitor file system.mon. You can use the **SET NODE/DETECTION_INTERVAL** command to change the timing of the updates.

Remembered expressions may also be substituted in any Boolean formula in subsequent **DISPLAY** commands. To substitute a remembered formula, use the dollar sign (\$) followed by expression_name, followed by the severity of the formula you wish to substitute.

Each node monitors itself based on the rules in **SYSTEM.MON**. RTR Explorer displays reflect new rules added or changed default rules.

To write your own rules, you can use any *selitms* and information classes available in the C API `rtr_request_info` call. For example, `rtr:ncf_isolated` uses the "rtr" info class and the "ncf_isolated" *selitm*.

Parameters

expression_name

Specifies the name of the expression to be remembered. There is no default. If the command is given without an expression, (that is, there are no rules for monitoring), a warning is issued to the user. The warning is also presented if

REMEMBER EXPRESSION

SYSTEM.MON is missing or contains no rules by which the node can monitor itself.

Qualifiers

/ERROR[=Boolean-expression]

If Boolean-expression yields true, then this rule is considered to be in an error state. Nodes will report an error when performing internal problem detection.

/FATAL[=Boolean-expression]

If Boolean-expression yields true, then this rule is considered to be in a fatal state. Nodes will report a fatal problem when performing internal problem detection.

/MGERROR[=text-string]

Specifies the error message that will be reported if Boolean-expression specified by the /ERROR qualifier yields true.

/MGFATAL[=text-string]

Specifies the fatal message that will be reported if Boolean-expression specified by the /FATAL qualifier yields true.

/MGWARN[=text-string]

Specifies the warning message that will be reported if Boolean-expression specified by the /WARNING qualifier yields true.

/WARNING[=Boolean-expression]

If Boolean-expression yields true, then this rule is considered to be in a warning state. Nodes will report a warning when performing internal problem detection.

Related commands

- DISPLAY BAR
- DISPLAY NUMERIC
- DISPLAY STRING
- DISPLAY SYMBOLIC
- DISPLAY TEXT
- MONITOR
- CLEAR

Examples

```

! Warn if we have a journal and free space is less than 30%
! Give an error if we have a journal and free space is less than 15%
! Give a fatal if we have a journal and journal free space is less than 1%
REMEMBER EXPRESSION JOURNAL -
/WARNING="(((jnl_lcl_nr_free_segments/jnl_lcl_nr_segments)*100)
< 30)&(jnl_lcl_open_journals <> 0))" -
/ERROR="(((jnl_lcl_nr_free_segments/jnl_lcl_nr_segments)*100)
< 15)&(jnl_lcl_open_journals <> 0))" -
/FATAL="(((jnl_lcl_nr_free_segments/jnl_lcl_nr_segments)*100)
< 1)&(jnl_lcl_open_journals <> 0))" -
/MGWARN="Either the journal is non-existent or the journal
is between 70-84 percent full" -
/MGERROR="The journal is between 85-99 percent full" -
/MGFATAL="The journal is 100 percent full"
.
.
.
DISPLAY TEXT "WARNING" /SELECT="$JOURNAL_WARNING"
DISPLAY TEXT "ERROR" /SELECT="$JOURNAL_ERROR"
DISPLAY TEXT "FATAL" /SELECT="$JOURNAL_FATAL"

```

These commands remember a rule for journal free space. If these commands were present in `system.mon`, then the expression "Journal" would be evaluated for each internal problem detection cycle. In addition, each of the display commands substitutes the `/MGWARN`, `/MGERROR`, and `/MGFATAL` qualifier messages, respectively, in the `/SELECT` qualifier.

RTR

RTR

The **RTR** command invokes the RTR command line interface.

Note

This command is not available in the RTR web browser interface.

Format

RTR

Description

The RTR command causes the RTR command line interface to be invoked and presents the RTR> prompt to accept commands.

Parameters

None.

Related commands

- START RTR

Examples

```
% ❶  
RTR ❷  
RTR> START RTR ❸
```

- ❶ Displays the operating system prompt.
- ❷ Invokes the RTR CLI.
- ❸ Starts the RTRACP application control process.

SCROLL

The **SCROLL** command scrolls a monitor picture.

Note

This command is not available in the RTR web browser interface.

Format

SCROLL direction [amount]

Description

The **SCROLL** command causes the last picture that was displayed using the **MONITOR** command to be scrolled in the direction specified and then redisplayed.

Parameters

direction

Specifies the direction in which the screen is to be scrolled. Can be one of **LEFT**, **RIGHT**, **UP**, **DOWN** or **HOME**.

HOME scrolls the picture so that its top-left corner coincides with the top-left corner of the screen.

amount

Specifies the number of rows/columns by which the screen is scrolled. Amount is ignored if direction is specified as **HOME**.

Related commands

- **MONITOR**

SCROLL

Examples

```
RTR> MONITOR TPS/INTERVAL=10) ❶  
RTR> SCROLL UP 10 ❷  
RTR> SCROLL HOME ❸
```

- ❶ Displays the TPS picture. This picture displays each process using RTR on a separate line. If there is insufficient space on the screen to display them all, the SCROLL command can be used to view a different portion of the list of processes.
- ❷ Scrolls the picture up 10 lines. Note that SCROLL automatically redisplay the current picture.
- ❸ Restores the original picture position.

SET ENVIRONMENT

The **SET ENVIRONMENT** command specifies the node where RTR commands entered from the same RTR> prompt are executed.

Note

This command is not available in the RTR web browser interface.

Format

SET ENVIRONMENT

Command Qualifiers

/CLUSTER

/NODE[=node-list]

Defaults

/NOCLUSTER

/NODE=this_node

Description

The **SET ENVIRONMENT** command causes RTR commands entered from the same RTR> prompt to be executed on the specified nodes. Entering **SET ENVIRONMENT** without any qualifiers causes RTR commands entered from the same RTR> prompt to be executed on the local node only. This command must be entered at the RTR> prompt. It cannot be executed from the operating system prompt or command line.

Qualifiers

/CLUSTER

Specifies that RTR commands entered from the same RTR> prompt are executed on all nodes in the cluster.

/NODE[=node-list]

Specifies that subsequent RTR commands are executed on all nodes specified in node-list. The node-list is a comma-separated list of nodenames in parentheses. If node-list is omitted, or both the /NODE and /CLUSTER qualifiers are omitted, subsequent commands are executed on only the local or current node.

SET ENVIRONMENT

Related commands

- SHOW ENVIRONMENT

Examples

See Section 1.6, Remote Commands, for examples of how to use the SET ENVIRONMENT command.

SET FACILITY

The **SET FACILITY** command sets various facility-related options.

Format

```
SET FACILITY facility-name
```

Command Qualifiers	Defaults
/BROADCAST_MINIMUM_RATE=Bps	/BROADCAST_MINIMUM_RATE=1000
/BALANCE	/NOBALANCE
/CLUSTER	/NOCLUSTER
/NODE[=node-list]	/NODE=default-node
/OUTPUT[=filespec]	/OUTPUT=stdout
/QUORUM_THRESHOLD=n	/QUORUM_THRESHOLD=0
/REPLY_CHECKSUM	/NOREPLY_CHECKSUM

Description

The **SET FACILITY** command sets the router load balancing and quorum characteristics of a facility.

Qualifiers

/BROADCAST_MINIMUM_RATE=Bps

/BROADCAST_MINIMUM_RATE=1000

/BROADCAST_MINIMUM_RATE=nnnn specifies the minimum rate (in bytes per second) to which flow control can reduce broadcast traffic on outgoing facility links from the node concerned.

For example, consider a facility has 100 frontends and 99 of them are able to receive data at a rate of 2KB per second, but one frontend has become congested and is not able to receive any. This can result in all the frontends slowing down to the rate that the slowest can accept.

Specifying **/BROADCAST_MINIMUM_RATE=2000** on the router ensures that the 99 frontends receive their broadcasts, and that RTR attempts to send the broadcasts to the congested frontend. However, broadcasts for the congested frontend are discarded (if absolutely necessary) rather than slowing down all frontends to the rate that the slowest can accept.

Specifying **/BROADCAST_MINIMUM_RATE** without a value gives a default 1000 bytes per second; if you do not use the qualifier, the minimum is zero.

SET FACILITY

/BALANCE

/NOBALANCE

/BALANCE specifies whether router load balancing is to be performed.

The default behavior (**/NOBALANCE**) is for a frontend to connect to the preferred router. Preferred routers are selected in the order specified in the **/ROUTER** qualifier of the **CREATE FACILITY** command. This preference is subject to the router being available and quorate. See Section 2.8, Router Load Balancing, for more information on load balancing.

/CLUSTER

/NOCLUSTER (D)

Specifies that the command is executed on all the nodes in the cluster.

If neither **/NODE** nor **/CLUSTER** is specified, the command is executed on the nodes specified by the latest **SET ENVIRONMENT** command. If no **SET ENVIRONMENT** command has been entered, the command is executed only on the node where the command was issued.

Note

In environments that do not support remote command capability, the **/CLUSTER** qualifier causes the relevant command to be executed on the local node only.

/NODE[=node-list]

/NODE=default-node (D)

Specifies that the command is executed on all nodes specified in *node-list*. If *node-list* is omitted, the command is executed only on the node where the command was issued.

/OUTPUT[=filespec]

/OUTPUT=stdout (D)

Specifies that the resulting information is written to the file *filespec*. If **/OUTPUT** or *filespec* is omitted, the standard or default output is used.

/QUORUM_THRESHOLD=n

/QUORUM_THRESHOLD=0

/QUORUM_THRESHOLD=n sets the minimum number of node/role combinations that must be reachable to declare the configuration quorate.

Note

A node that combines both backend and router roles is counted twice in determining the threshold. A value of zero implies that the RTR determined threshold (half the number of node/role pairs configured plus one) is used. This is the default value; do not alter it unless you are sure that the unreachable nodes are really down. Before the rest of the nodes are started, this value should be reset to zero, the default setting.

The current value of `quorum_threshold` can be displayed with the `SHOW FACILITY /STATE` command.

/REPLY_CHECKSUM

/NOREPLY_CHECKSUM (D)

Specifies that the reply consistency check (or Response Matching) feature for replayed messages is enabled. It is a check for reply consistency during a replay of a reply to client message.

RTR can enable, disable and display this feature.

Note

This command must be entered on a frontend.

Related commands

- `SHOW FACILITY`

Examples

```
RTR> SET FACILITY FINANCE/QUORUM_THRESHOLD=4
quorum threshold set to 4 (from 0) for facility FINANCE
```

The `SET FACILITY` command tells RTR to set the quorum threshold to four for facility `FINANCE`. This command should be used on all the backend and router nodes in the facility.

```
RTR> SET FACILITY FINANCE/BALANCE
```

This command tells RTR to use router load balancing.

SET LINK

SET LINK

The **SET LINK** command sets various link related options.

Format

```
SET LINK link-name
```

Command Qualifiers	Defaults
/AUTOISOLATE	/NOAUTOISOLATE
/ENABLE	/DISABLE
/CHECKSUM	/NOCHECKSUM
/COUNT[=secs]	/COUNT=3
/CLUSTER	/NOCLUSTER
/INACTIVITY_TIMEOUT[=secs]	/INACTIVITY_TIMEOUT=node-default
/NODE[=node-list]	/NODE=default-node
/OUTPUT[=filespec]	/OUTPUT=stdout
/SUSPECT	/NOSUSPECT
/TIMER[=secs]	/TIMER=600

Description

The **SET LINK** command sets options for one or more links. The options are link enabled or disabled, link autoisolate, link checksum and link inactivity timeout.

The parameter `link-name` is the node from which connect attempts are to be honored (or not). Note that disabling the link prevents incoming connections over an established link. It only takes effect when new connect attempts are made. It does not affect the ability to connect to a node whose link has been disabled. The `link-name` can be wildcarded.

Display the current state of the link with the **SHOW LINK/STATUS** command. When looking at connection problems, look at both ends of the link counters with the **SHOW LINK/COUNTER** command.

Qualifiers

/AUTOISOLATE

/NOAUTOISOLATE (D)

Any RTR node may disconnect a remote node if it finds the remote node is unresponsive or congested. The normal behavior following such action is automatic network link reconnection and recovery.

Node autoisolation allows a node (the isolator) to disconnect a congested or unresponsive remote node (the isolatee) in such a way that when the congested node attempts to reconnect, it receives an instruction to close all its network links and cease connection attempts. A node in this state is termed **isolated**.

Some applications require that a node suspected of causing congestion (that is, not processing network data quickly enough) is isolated from the rest of the network, so as to cause minimum disruption. The node autoisolation feature meets this requirement.

Remote node autoisolation can be enabled (at the isolator) where it applies to all links using SET NODE/AUTOISOLATE, or for specific links only with the SET LINK/AUTOISOLATE command. An isolated node (isolatee) remains isolated until you perform both of the following actions:

- Enable the link to the isolated node on all nodes that have isolated it, that is set link [isolated-node]/enable
- Exit the isolated state on the isolated node, that is set node/noisolate

Autoisolation is disabled (at the isolator) using the /NOAUTOISOLATE qualifier.

/CHECKSUM

/NOCHECKSUM (D)

/CHECKSUM specifies that checksum calculations for data packets over network links are performed. This qualifier is by default set to /NOCHECKSUM.

This command is useful for diagnosing errors over network links. To see the checksum state, use the SHOW LINK/STATE command.

/ENABLE

/DISABLE

/ENABLE specifies that connect attempts are honored from the node specified by link-name.

This command is used to enable a link in a disabled state. A link can be disabled either as a result of operator action, or automatically if it has been suspected of causing severe congestion. If a link is automatically disabled, an entry is made in the RTR error log.

/DISABLE specifies that connect attempts are no longer honored from the node link-name. Note that disabling the link does not have any immediate effect on an established link. It only takes effect when new connection attempts are made.

SET LINK

/CLUSTER

/NOCLUSTER (D)

Specifies that the command is executed on all the nodes in the cluster.

If neither **/NODE** nor **/CLUSTER** is specified, the command is executed on the nodes specified by the latest **SET ENVIRONMENT** command. If no **SET ENVIRONMENT** command has been entered, the command is executed only on the node where the command was issued.

Note

In environments that do not support remote command capability, the **/CLUSTER** qualifier causes the relevant command to be executed on the local node only.

/COUNT[=secs]

/COUNT=3 (D)

/COUNT specifies the number of connect attempts within the stipulated time that are honored from the node specified by link-name before autoisolating it. The default value for **/COUNT** is 3.

The stipulated time limit can be set by using the **/TIMER** qualifier.

/INACTIVITY_TIMEOUT[=secs]

/INACTIVITY_TIMEOUT=node-default

/INACTIVITY_TIMEOUT[=secs] specifies the maximum elapsed time in seconds before RTR discards a link that is neither receiving traffic nor responding to explicit link state queries. Link failover occurs between the adjustable environmental timer parameters **RTR_TIMEOUT_CONNECT**, default of 60 seconds, and **RTR_TIMEOUT_CONNECT_RELAX**, default of 90 seconds, on a network link or remote node. When there is a failure, RTR detects it within the timer parameters stipulated and disconnects and retries the link according to the router preferences for a frontend. If a router fails to respond to the reconnect tries, there will be a time lapse of **RTR_TIMEOUT_CONNECT** plus **RTR_TIMEOUT_CONNECT_RELAX** for the link failover to occur.

The new value for **secs** becomes effective only after a time of about one third of the current value of the link inactivity timeout.

The minimum useful value for **secs** is three. If a value is not specified, links inherit the current value of the node inactivity timeout. (See **SET NODE/INACTIVITY_TIMEOUT**.)

You can check the current value of the link inactivity timeout with the command **SHOW LINK linkname/COUNTER=ndb_lw_inact**.

You should not specify a value of less than five times the time required for a round trip over the link. If you don't know this value, RTR can measure it for you. Make sure that there is no transactional traffic over the link, and monitor the link (with the MONITOR LINK command) between the two nodes whose round trip time you want to measure. After a few minutes, look at the link counters `ndb_lw_trips` and `ndb_lw_trips_ms` using the `SHOW LINK/COUNTER=ndb_lw_trips*` command. Dividing the latter by the former yields the average round trip time in milliseconds.

Note

The inactivity timeout is used for all RTR links, but the effect of a timeout and failover depends on what connections the link is supporting. In brief, a link between a router and a backend timing out causes a router or backend failover and quorum re-negotiations. A frontend will search for another router.

/NODE[=node-list]

/NODE=default-node (D)

Specifies that the command is executed on all nodes specified in `node-list`. If `node-list` is omitted, the command is executed only on the node where the command was issued.

/OUTPUT[=filespec]

/OUTPUT=stdout (D)

Specifies that the resulting information is written to the file `filespec`. If `/OUTPUT` or `filespec` is omitted, the standard or default output is used.

/SUSPECT

/NOSUSPECT

Obsolete. Available for compatibility reasons only; use `/AUTOISOLATE` instead.

/TIMER=[secs]

/TIMER=600 (D)

`/TIMER` specifies the time limit within which the stipulated connect attempts are honored from the node specified by the link-name before autoisolating it. The default value for `/TIMER` is 600 seconds.

The stipulated connect attempts can be set by using the `/COUNT` qualifier.

SET LINK

Related commands

- SET NODE/AUTOISOLATE
- SHOW LINK/STATUS

Examples

```
RTR> SET LINK JOEY/ENABLE
```

This command reallows connections from node JOEY.

```
RTR> SET LINK JOEY/AUTOISOLATE
```

This command sets the autoisolate attribute on the link to node JOEY.

SET LOG

The **SET LOG** command specifies where RTR writes its log messages.

Format

```
SET LOG/FILE=[:]filespec.log
```

Command Qualifiers	Defaults
/CLUSTER	/NOCLUSTER
/FILE= <i>filespec-list</i>	/NOFILE
/NODE[= <i>node-list</i>]	/NODE=default-node
/OPERATOR	/NOOPERATOR
/OUTPUT[= <i>filespec</i>]	/OUTPUT=stdout
/SUPERSEDE	/NOSUPERSEDE

Description

The LOG command lets you enter text that is written to the current log file. Use the SET LOG command to specify the name of the file where logged messages are written, or log messages only to the operator console by using the /OPERATOR qualifier on the SET LOG command. On UNIX and Linux, SET LOG/OPERATOR places log entries into the system log where applications write their standard log entries. On Windows, you can view the RTR entries from Control Panel → Administrative Tools → Event Viewer → Application Log, looking for RTR entries, or use Notepad to view entries in a named log file.

You use the SET LOG command to specify a new file and close the old one. Purge log files periodically to avoid problems with full disks.

Messages written to the log file are text including a LOGFILENT code, a timestamp, an RTRLOGENT code and the message. See the example at the end of this command description.

There is no restriction on how many files you name, but each is mutually exclusive. Once you specify a new file, the old one is closed. You cannot log messages to a file and also to the operator console. Long filenames are supported.

Log files must be periodically purged to avoid difficulties with full disks. Do this by using SET LOG to specify a new file and deleting the old one.

If neither the /OPERATOR nor the /FILE qualifier is specified, logging is suppressed.

SET LOG

The /SUPERSEDE qualifier specifies that files specified with the /FILE qualifier are to be overwritten.

Log Files Must Always Be Accessible

Log files must always be accessible even if a node fails.

The following commands are logged; all others are not logged.

- ADD command
- CREATE commands
- DELETE commands, but not DELETE KEY
- EXTEND command
- FLUSH command
- MODIFY command
- SET commands, but not SET ENVIRONMENT
- STOP commands
- TRIM command
- INITIALIZE command
- START commands
- REGISTER RM command
- UNREGISTER RM command

Qualifiers

/CLUSTER

/NOCLUSTER (D)

Specifies that the command is executed on all the nodes in the cluster.

If neither /NODE nor /CLUSTER is specified, the command is executed on the nodes specified by the latest SET ENVIRONMENT command. If no SET ENVIRONMENT command has been entered, the command is executed only on the node where the command was issued.

Note

In environments that do not support remote command capability, the /CLUSTER qualifier causes the relevant command to be executed on the local node only.

/FILE=filespec-list

/NOFILE (D)

Specifies the names of up to four files where the log messages are written.

/NODE[=node-list]

/NODE=default-node (D)

Specifies that the command is executed on all nodes specified in `node-list`. If `node-list` is omitted, the command is executed only on the node where the command was issued.

/OPERATOR

/NOOPERATOR (D)

Specifies that log messages are written only to the operator console.

/OUTPUT[=filespec]

/OUTPUT=stdout (D)

Specifies that the resulting information is written to the file `filespec`. If `/OUTPUT` or `filespec` is omitted, the standard or default output is used.

/SUPERSEDE

/NOSUPERSEDE (D)

Specifies files identified with the `/FILE` qualifier for overwriting. A file specified by the `/FILE` qualifier that does not exist is created. An existing file specified by the `/FILE` qualifier on an operating system that does not have file version numbers is overwritten. An existing file specified by the `/FILE` qualifier on an operating system that uses file version numbers is closed and a new file with a new version number is opened.

The `/SUPERSEDE` qualifier does not apply to the `/OPERATOR` qualifier. The operator console is not overwritten.

Related commands

- SHOW LOG

Examples

```
RTR> SET LOG/FILE=RTRLOG.LOG/OPERATOR
```

This command tells RTR to write log messages to the file `RTRLOG.LOG` and to the operator log.

```
RTR> SET LOG/NOFILE/NOOPERATOR
```

This command suppresses all RTR log messages.

SET LOG

```
RTR> SET LOG/FILE="/usr/users/rtruser/daily_logfile"
```

This command tells RTR to write log messages to the file /usr/users/rtruser/daily_logfile.log.

```
RTR> SET LOG/FILE=("logfile1.log","logfile2.log")
```

This command tells RTR to write log messages to logfile1.log and logfile2.log.

```
RTR> SET LOG/OPERATOR
```

This command tells RTR to write log messages to the system log.

The following is an example of the contents of an RTR log file.

```
( c ) %RTR-I-LOGFILENT, Thu Jul 15 13:51:09.098 2004 NODEA 1744
%RTR-I-EXERTRCOM, command: start rtr/node=(NODEA)/format=html
( c ) %RTR-I-LOGFILENT, Tue Jul 20 14:26:42.975 2004 NODEA 1744
%RTR-I-EXERTRCOM, command: start http
( c ) %RTR-I-LOGFILENT, Tue Jul 20 14:26:43.006 2004 NODEA 1744
%RTR-I-HTTPSTART, HTTP server started for user haramundanis
( c ) %RTR-I-LOGFILENT, Wed Jul 21 11:44:56.079 2004 NODEA 1744
%RTR-I-EXERTRCOM, command: create journal "C:"/node=(NODEA )/format=html
( a ) %RTR-I-LOGFILENT, Wed Jul 21 11:46:21.278 2004 NODEA 1948
%RTR-I-EXERTRCOM, command: create facility DESIGN/frontend=(NODEA )/router=
(NODEA )/backend=(NODEA )/node=(NODEA )/format=html
( a ) %RTR-I-LOGFILENT, Wed Jul 21 11:46:21.700 2004 NODEA 1948
%RTR-I-COMJOUSEA, commencing journal search of node NODEA for transactions
on facility DESIGN needing recovery
( a ) %RTR-I-LOGFILENT, Wed Jul 21 11:46:21.731 2004 NODEA 1948
%RTR-I-JOUSEACOM, journal search of node NODEA facility DESIGN completed.
0 recoverable transactions found
( a ) %RTR-I-LOGFILENT, Wed Jul 21 11:46:21.731 2004 NODEA 1948
%RTR-I-FACSTARTTR, facility DESIGN started on node NODEA as router
( a ) %RTR-I-LOGFILENT, Wed Jul 21 11:46:21.762 2004 NODEA 1948
%RTR-I-FACSTARTBE, facility DESIGN started on node NODEA as backend
( a ) %RTR-I-LOGFILENT, Wed Jul 21 11:46:21.778 2004 NODEA 1948
%RTR-W-RSPFAC, response from Node NODEA about Facility DESIGN
%NCF-I-I STATUS_TEXT, Router has no quorum in facility %s
%NCF-I-I STATUS_IS, -9371494 (10)
( a ) %RTR-I-LOGFILENT, Wed Jul 21 11:46:21.778 2004 NODEA 1948
%RTR-E-NOCURRTR, current router search failed for facility DESIGN
( a ) %RTR-I-LOGFILENT, Wed Jul 21 11:46:21.793 2004 NODEA 1948
%RTR-I-BEINQUO, backend is quorate in facility DESIGN
```

SET MODE

The **SET MODE** command specifies whether RTR runs in group or nogroup (system) mode.

Format

SET MODE

Command Qualifiers

/CLUSTER
 /GROUP[=user-id]
 /NODE[=node-list]
 /OUTPUT[=filespec]

Defaults

/NOCLUSTER
 /NOGROUP
 /NODE=default-node
 /OUTPUT=stdout

Description

The SET MODE command specifies whether RTR runs in group or nogroup mode. (Nogroup mode may also be called system mode).

Production systems use RTR in the default (nogroup) mode, whereby all users running in this mode use one common invocation of RTR.

Each developer typically has his or her own invocation of RTR to avoid having their use of RTR affect other developers or the production system. This mode is called group mode. Group mode allows development or testing of applications by several groups of people on the same physical system without interference.

Note

RTR does not execute any remote commands for a different group, and cannot set remote group different from the local group. To set a different mode for a remote user on a remote node, use SET MODE/GROUP first on the local node, then reissue SET MODE/GROUP as a remote command.

Qualifiers

/CLUSTER
/NOCLUSTER (D)

Specifies that the command is executed on all the nodes in the cluster.

SET MODE

If neither `/NODE` nor `/CLUSTER` is specified, the command is executed on the nodes specified by the latest `SET ENVIRONMENT` command. If no `SET ENVIRONMENT` command has been entered, the command is executed only on the node where the command was issued.

Note

In environments that do not support remote command capability, the `/CLUSTER` qualifier causes the relevant command to be executed on the local node only.

/GROUP[=user-id]

/NOGROUP (D)

`/GROUP` specifies that RTR be set to `GROUP` mode for the user who issues the command. The group name defaults to the first eight characters of your current user-id. A group name can contain only alphanumeric characters, and “-”, hyphen, “\$”, dollar sign, or “_”, underscore characters. (If the RTR group name is changed to a name containing an invalid character such as “\”, backslash, RTR will not start in a later session.) You may also change to another group by entering a user or group ID. Note that group names are used for naming RTR journal files; do not use a group name containing the string `SYSTEM` or conflicts may occur.

```
RTR> set mode/group=develpr
```

`/NOGROUP` sets RTR into `NOGROUP` mode.

Note

This qualifier is not available in the RTR web browser interface.

/NODE[=node-list]

/NODE=default-node (D)

Specifies that the command is executed on all nodes specified in `node-list`. If `node-list` is omitted, the command is executed only on the node where the command was issued.

/OUTPUT[=filespec]

/OUTPUT=stdout (D)

Specifies that the resulting information is written to the file `filespec`. If `/OUTPUT` or `filespec` is omitted, the standard or default output is used.

Related commands

- SHOW MODE

Examples

```
RTR> SET MODE/GROUP
```

This command tells RTR to enter GROUP mode.

```
RTR> SET MODE/NOGROUP
```

This command tells RTR to enter NOGROUP mode.

SET NODE

SET NODE

The **SET NODE** command sets various node-related options.

Format

SET node

Command Qualifiers	Defaults
/AUTOISOLATE	/NOAUTOISOLATE
/CLUSTER	/NOCLUSTER
/DETECTION_INTERVAL=seconds	/DETECTION_INTERVAL=0
/INACTIVITY_TIMEOUT[=secs]	/INACTIVITY_TIMEOUT=60
/INFO_CACHE_LIFETIME=seconds	/INFO_CACHE_LIFETIME=20
/ISOLATE	/NOISOLATE
/NODE[=node-list]	/NODE=default-node-list
/OUTPUT[=file-spec]	/OUTPUT=stdout
/RECOVERY=recovery-protocol	/RECOVERY=V40
/ROUTER_RESPONSE_TIMEOUT=[secs]	/ROUTER_RESPONSE_TIMEOUT=30
/SWITCH_DELAY	/SWITCH_DELAY=1800
/TR_OK_DELAY[=seconds]	/TR_OK_DELAY=0

Description

The SET NODE command sets the automatic isolation characteristics, the link timeout default of a node, the `rtr_request_info` cache lifetime, and the recovery protocol.

Qualifiers

/AUTOISOLATE

/NOAUTOISOLATE (D)

Any RTR node may disconnect a remote node if it finds the remote node is unresponsive or congested. The normal behavior following such action is automatic network link reconnection and recovery.

Node autoisolation allows a node (the isolator) to disconnect a congested or unresponsive remote node (the isolatee) in such a way that when the congested node attempts to reconnect, it receives an instruction to close all its network links and cease connection attempts. A node in this state is termed **isolated**.

Some applications require that a node suspected of causing congestion (that is, not processing network data quickly enough) is isolated from the rest of the network, so as to cause minimum disruption. The node autoisolation feature meets this requirement.

Remote node autoisolation can be enabled (at the isolator) where it applies to all links using **SET NODE/AUTOISOLATE**, or for specific links only with the **SET LINK/AUTOISOLATE** command. An isolated node (isolatee) remains isolated until you perform both of the following actions:

- Enable the link to the isolated node on all nodes that have isolated it, that is **set link [isolated-node]/enable**
- Exit the isolated state on the isolated node, that is **set node/noisolate**

Autoisolation is disabled (at the isolator) using the **/NOAUTOISOLATE** qualifier.

/CLUSTER**/NOCLUSTER (D)**

Specifies that the command is executed on all the nodes in the cluster.

If neither **/NODE** nor **/CLUSTER** is specified, the command is executed on the nodes specified by the latest **SET ENVIRONMENT** command. If no **SET ENVIRONMENT** command has been entered, the command is executed only on the node where the command was issued.

Note

In environments that do not support remote command capability, the **/CLUSTER** qualifier causes the relevant command to be executed on the local node only.

/DETECTION_INTERVAL[=seconds]**/DETECTION_INTERVAL=0**

Nodes monitor themselves for problems on a set interval. The **/DETECTION_INTERVAL** qualifier lets you specify that interval. When the **/DETECTION_INTERVAL** is set to 0 there would be no data collection happening. See the **REMEMBER EXPRESSION** command for additional details.

/INACTIVITY_TIMEOUT[=secs]**/INACTIVITY_TIMEOUT=60**

/INACTIVITY_TIMEOUT[=secs] specifies the link inactivity timeout value for all current links, and also sets the default inactivity timeout value for new links. The default value is 60 seconds.

SET NODE

See SET LINK/INACTIVITY_TIMEOUT for further information.

/INFO_CACHE_LIFETIME[=*seconds*]

/INFO_CACHE_LIFETIME=20

The `rtr_request_info` gcs information class requires a backend to acquire data from all routers. Depending on the size of your configuration, this data acquisition may take some time and consume some bandwidth. Consequently, RTR caches the data available in the gcs information class for `info_cache_lifetime` seconds to avoid the overhead of data acquisition for every call.

The amount of time and bandwidth used is determined by two factors:

1. the size of your RTR configuration
2. the number of problems each computer is reporting

If you have a high speed network between your backend and routers, or a small RTR configuration, then you may set `info_cache_lifetime` to a small value. If your network is slower or you have a large configuration, then you may set `info_cache_lifetime` to a higher value.

/ISOLATE

/NOISOLATE (D)

The `/ISOLATE` qualifier is obsolete and is available for compatibility reasons only. Use `/AUTOISOLATE` instead.

Use `/NOISOLATE` to take a node out of the isolated state. (See the `/AUTOISOLATE` qualifier for further information).

/NODE[=*node-list*]

/NODE=default-node (D)

Specifies that the command is executed on all nodes specified in `node-list`. If `node-list` is omitted, the command is executed only on the node where the command was issued.

/OUTPUT[=*filespec*]

/OUTPUT=stdout (D)

Specifies that the resulting information is written to the file `filespec`. If `/OUTPUT` or `filespec` is omitted, the standard or default output is used.

/RECOVERY=recovery-protocol

/RECOVERY=V40 (D)

The `/RECOVERY` qualifier is used to set the recovery protocol to that used in RTR Version 3.2 and earlier and is used during rolling upgrades to RTR Version 4.0. If an RTR environment has many facilities with different mixes of

backend and router roles on a node (making it difficult to satisfy the conditions for a rolling upgrade), use this command to set the recovery protocol to V3.2. Once the upgrade is completed, you can revert to using the V4.0 recovery protocol by omitting this command the next time RTR is started. The protocol will default to V4.0.

RTR must be started for this command to have any effect. The recovery protocol must be specified before any recovery is initiated by RTR, therefore this command must be entered before any facilities are defined.

You can display the recovery protocol that is in effect for RTR by using the RTR node counter:

```
RTR> SHOW RTR/COUNTER=crm_be_recovery_protocol
```

/ROUTER_RESPONSE_TIMEOUT=[secs]

/ROUTER_RESPONSE_TIMEOUT=30 (D)

Specifies the router responsiveness timeout for all `rtr_request_info()` API calls specifying the `gcs` information class. When the `gcs` information class is specified with `rtr_request_info()`, the backend will contact all connected routers to obtain configuration and status data. Disconnected routers are not contacted. The backend waits until either all contacted routers have responded, or more than `ROUTER_RESPONSE_TIMEOUT` seconds have passed, whichever comes first, before making the data available to subsequent `rtr_receive_message()` calls.

Setting the `ROUTER_RESPONSE_TIMEOUT` value to 0 disables the timeout feature and causes the backend to wait until all routers have responded. If one or more routers do not respond, the backend will wait forever.

/SWITCH_DELAY

/SWITCH_DELAY=1800 (D)

`/SWITCH_DELAY` Specifies the delay, in seconds, before all partitions on the backend node switch from their normal priority to the lowest priority. This command only affects partitions on a backend node that are in a shadow configuration. Standby partitions are not affected.

After a backend loses sufficient link connectivity, the server partitions enter the `'wt_quorum'` state indicating that the backend does not have sufficient link connectivity to continue processing transactions. Normally, when sufficient link connectivity is regained, the partitions will revert to their original state after progressing through recovery. For a shadow partition, it will revert to primary active if it was primary active, or secondary active if it was secondary active.

SET NODE

Under normal operating conditions, this behavior is desirable. However, if links remain disconnected for a long time, the recovering backend may have a considerable backlog of transactions to process. If all partitions reverted to the primary active state, there would effectively be a dual site outage until those partitions had recovered the backlog of transactions.

Using the `SWITCH_DELAY` qualifier helps to resolve this issue. If a backend is in the 'wt_quorum' state for longer than `SWITCH_DELAY` seconds, all shadow partitions will automatically take the lowest priority. The affected partitions will become secondary active after sufficient link connectivity is regained, even if they were originally primary active.

This priority switch overrides implicit and explicit partition priorities, including the priorities set by the `SET PARTITION/PRIORITY_LIST` command.

Set this value to 0 to disable priority switching. If the value is set to 0, then shadowed partitions will always revert to their original partition states after sufficient link connectivity is regained, regardless of the duration of the disconnect.

`/TR_OK_DELAY=[secs]`

`/TR_OK_DELAY=0 (D)`

The `/TR_OK_DELAY` timer limits the duration for a partition waiting in `WAIT_TR_OK` state. The timer will be set when the partition goes to `WT_TR_OK` state. Upon the timer expiry, if the partition is still in the `WT_TR_OK` state, then all server channels will be closed with an appropriate error message. A value of '0' will disable the timer.

Related commands

- `SHOW NODE`
- `SET LINK`

Examples

```
RTR> SET NODE /NOISOLATE
```

This command tells RTR to set the executing node non-isolated.

SET PARTITION

The **SET PARTITION** command sets various partition-related options.

Format

```
SET PARTITION partition-name
```

Command Qualifiers	Defaults
/FACILITY[=facility_name]	/FACILITY=RTR\$DEFAULT_FACILITY
/FAILOVER_POLICY=(SHADOW STAND_BY)	None
/IGNORE_RECOVERY	/NOIGNORE_RECOVERY
/PRIORITY_LIST=(BE-node1, BE-node2, ...)	None
/RECOVERY_RETRY_COUNT=n	No limit
/RESTART_RECOVERY	None
/RESUME	None
/SHADOW	/NOSHADOW
/SUSPEND	None
/TIMEOUT=nn	None (nn in seconds)

Description

The **SET PARTITION** command sets the characteristics of a named partition. Only backend partitions may be manipulated with this command; the command must be entered on the backend where the partition is located.

Use **SET PARTITION** any time after the partition has been created (either explicitly by **CREATE PARTITION** or implicitly by starting a server.) Note that the command only takes effect after the first server joins a partition. Any errors encountered at that time will appear as RTR log file entries. Using **SET PARTITION** to change the state of the system results in a log file entry.

See Chapter 3, Partition Management for a more detailed description of situations where the **SET PARTITION** command might be used and see Section 2.16, Assignment of Processing States for Partitions for information on how RTR establishes partition states.

Parameters

partition-name

The name of the partition being manipulated. This can be specified as `partition_name` (if the partition name is unique on the node), or as `facility_name:partition_name`.

SET PARTITION

Qualifiers

/FACILITY=facility_name (D)

Determines the facility that the partition command will act on. This is required.

/FAILOVER_POLICY=SHADOW

/FAILOVER_POLICY=STAND_BY (D)

Determines the action to take when the primary partition fails. This qualifier lets the system manager decide which site to make active when the current primary site is lost. The administrator can select failover *to a standby* or *to a remote shadow site*.

The default action is to allow a standby of the primary to become the new primary. Optionally, RTR can be set to change state so that the secondary becomes primary, and a standby of the old primary (if any) becomes the new secondary.

If the /FAILOVER qualifier is used once on any backend, it affects all other partition instances with the same key range.

/IGNORE_RECOVERY

/NOIGNORE_RECOVERY (D)

Forces the partition to exit any current wait state it may be in.

If a partition should enter a wait state or fail because of the unavailability of either a local or remote journal, use this command to override the default RTR behavior. It instructs RTR to skip the current step in the recovery process. Since this command bypasses parts of the recovery cycle, use it with caution, and only when availability is more important than consistency in your application databases.

This qualifier applies only to the backend on which the command is entered.

/PRIORITY_LIST=(BE-node1,BE-node2,...)

Sets a relative priority that is used by RTR when selecting a backend member to make active. Enter a list of the backends in your configuration in decreasing order of priority; the relative order of the list will be taken into consideration when RTR is determining on which node to make a partition active. This qualifier applies only to the backend on which the command is entered, and should be entered in the same form on all backends.

It is not an error to enter different versions of the priority list at different backends, but this is not recommended. You should suspend partitions before changing the priority list.

Note that the priority of the backend given here is a preference but is not an absolute. If possible, RTR will make a higher priority backend active. However, in some circumstances a higher priority backend will not become active due to other overriding considerations, for example if a backend with an active partition in a cluster is isolated from the network due to link disconnects. After the backend is isolated, the standby partner may request access to the journal, at which point the active backend will yield control of the journal and automatically reset all its partitions to the lowest priority. Thus, if the backend's links are reconnected, the partitions will then become standby instead of active. This behavior ensures that failover does not occur twice unnecessarily.

To defeat this behavior and to have the backend's partitions retain their original priority, define the environment variable `RTR_JNL_PARTITION_FAILBACK` and restart all RTR processes. Then in the aforementioned scenario, the backend's partitions would not be automatically reset to the lowest priority. Thus upon link reconnect the backend's partitions would become active instead of standby.

Note that the journal failback scenario mentioned above applies only to an active/standby configuration. It does not apply to a shadow configuration.

/RECOVERY_RETRY_COUNT=n

If an application server dies while processing a transaction recovered from the journal, RTR will present the transaction to another (concurrent or standby) server. The `RECOVERY_RETRY_COUNT` indicates the maximum number of times the transaction is presented to a server for recovery before being written to the journal as an exception.

There are two types of recovery operations where transactions are recovered from the journal: local recovery and shadow recovery. Shadow recovery is the process of recovering the remembered transactions written to a primary shadow journal while the secondary shadow site is down.

The `SET PARTITION /RECOVERY_RETRY_COUNT` parameter does not have any effect on remembered transactions recovered during shadow recovery. That is, if there is a killer transaction remembered in the journal on a primary shadow node, on this node RTR does not count the number of times the transaction is recovered by a recovering secondary shadow node. The way to ensure that a remembered transaction will be exceptioned by RTR is by starting a sufficient number of concurrent servers on the recovering secondary shadow node.

SET PARTITION

For this reason, the number of concurrent secondary shadow servers started should be greater than the value set for the `RECOVERY_RETRY_COUNT` on a partition. This will ensure that a remembered (killer) transaction being recovered from a primary shadow journal will be exceptioned if the retry limit is exceeded.

Note that only those transactions that have reached voting stage on a server can be exceptioned. If a server always dies before voting on a transaction, the transaction will be aborted by RTR after the third try. This is a hard-coded limit (the so-called "three strikes and you're out" feature).

/RESTART_RECOVERY

Restarts the recovery cycle. The recovery cycle can be manually restarted with `/RESTART`. This is useful if the operator previously aborted recovery through use of `/IGNORE_RECOVERY`. Since this command may result in recovery of transactions from previously inaccessible journals, it should not be used if your applications are sensitive to the order in which transactions are processed by the servers. This qualifier applies only to the backend on which the command is entered.

/RESUME

Resume normal operations (that is, cancel a `/SUSPEND` command). If the partition is already in the desired state, the command has no effect. This qualifier applies only to the backend on which the command is entered.

/SHADOW

/NOSHADOW (D)

Turns shadowing on or off for the specified partition.

Shadowing for a partition can be turned off only in the absence of an active secondary site, that is, the active member must be running in remember mode. The command will fail if it is entered on either an active primary or secondary. Once shadowing is disabled, the secondary site servers will be unable to start up in shadow mode until shadowing is enabled again.

Shadowing for the partition can be turned on by entering the command at the current active member.

If the `/SHADOW` qualifier is used once on any backend, it affects all other partition instances with the same key range.

If shadowing is already in the desired mode, the command has no effect.

Note

If the `SET PARTITION/NOSHADOW` command is used on a remembered partition, the operator must take action regarding the remembered transactions in the journal:

- Either leave them in place pending restoration of future shadow operation
 - or delete them with the `SET TRANSACTION` command.
-

/SUSPEND

Stops presenting new transactions on the specified partition until a `/RESUME` is issued.

Use `/SUSPEND` to temporarily halt the presentation of new transactions to servers on the backend where the command is entered. The command completes when the processing of all currently active transactions is complete. This qualifier applies only to the backend on which the command is entered.

The optional `/TIMEOUT` qualifier may be used to limit the time in seconds that the command waits for completion. If the command times out, presentation of new transactions is suspended, but there still exist transactions for which servers have yet to complete processing. The operator must decide to either reenter the command and wait a longer period of time, or resume the partition. Using this command does not affect any transaction timeout value specified by RTR clients, so such transactions may encounter a timeout condition if the partition remains suspended.

If the command times out (cannot be completed within the specified timeout period), transaction presentation remains set to active.

/TIMEOUT

See description for `/SUSPEND`.

Related commands

- `CREATE PARTITION`
- `SHOW PARTITION`

SET TRANSACTION

SET TRANSACTION

The **SET TRANSACTION** command sets various transaction-related options.

Format

SET TRANSACTION [transaction-id]

Command Qualifiers	Defaults
/BEFORE[=date]	Today
/FACILITY=facility_name	/FACILITY=RTR\$DEFAULT_FACILITY
/NEW_STATE=new_state	None
/NODE[=node_list]	/NODE=default_node
/OUTPUT[=filespec]	/OUTPUT=stdout
/PARTITION=partition_name	None
/SINCE[=date]	Today
/STATE=current_state	None
/USER=username	All users

Description

The **SET TRANSACTION** command allows you to modify the state of a transaction or set of transactions stored in the RTR journal.

Caution

The **SET TRANSACTION** command could damage your journal and compromise database integrity if used incorrectly. Ensure that you fully understand the reason and impact for changing a transaction state before altering your RTR system.

This command is complementary to the **DUMP JOURNAL** and **SHOW TRANSACTION** commands in that it gives capability of reading and modifying the status of a transaction status in the RTR journal. For example, if a shadow recovery is known to be unnecessary, you may want to clean up the RTR journal to prevent the committed transactions in the journal from being replayed. Using the **SET TRANSACTION** command, the RTR administrator is able to delete that set of transactions from the journal.

In addition, the SET TRANSACTION command also helps users to better control the RTR runtime environment in difficult operational situations. For example, a transaction that is still in SENDING state on the backend may appear to be hung and cannot proceed. Using the SET TRANSACTION command, an RTR administrator can abort this transaction “on-the-fly” and free runtime resources.

While the SET TRANSACTION command enables RTR users to have full control of RTR transactions, it introduces the risk that a transaction could be lost or corrupted. The command must be used with discretion and only by experienced RTR system administrators.

After the SET TRANSACTION command completes, you may use the DUMP JOURNAL command to verify the results.

Refer to Chapter 4, Transaction Management, for more information about transaction management and the SET TRANSACTION command.

Usage Notes

The command can only be executed on a backend node on which the journal is located and the RTR log file must be turned on to record the transaction changes. RTR needs to be started before using this command.

When you modify a transaction’s state, you must specify the qualifier /PARTITION in addition to the required qualifiers /STATE and /NEW_STATE. Specifying this information ensures that RTR locates the specific transaction branch.

When a transaction’s state is changed, the new state is written to the RTR journal synchronously. RTR will try to determine whether the change also affects other portions of the RTR environment. For example, in a runtime situation where RTR routers and RTR backend servers are active, the RTRACAP will send the new status to application servers as well as RTR routers to make sure that the change takes effect on all nodes in the RTR facility or facilities.

However, in an off-line situation where an RTR facility has not been created, RTR will simply update the transaction state in place in the RTR journal. The RTR log file must be turned on before using the SET TRANSACTION command to record the state changes. See the SET LOG command.

There are eight legitimate situations where you can change a transaction’s state. See Table 9–22.

SET TRANSACTION

Parameters

transaction-id

Specifies a particular transaction or transactions whose transaction state you want to change. The `transaction_id` format is the same as that displayed by the `DUMP JOURNAL` and `SHOW TRANSACTION` commands.

If no `transaction_id` is specified, all transactions (*) that satisfy the specifying qualifiers are processed by the command.

Qualifiers

/BEFORE[=date]

Selects only those transactions whose timestamp is before the specified date. Default is the current date.

/FACILITY

/FACILITY=RTR\$DEFAULT_FACILITY (D)

Specifies the name of a facility for selecting transactions. The default facility, `RTR$DEFAULT_FACILITY`, is used if this qualifier is not specified.

/NEW_STATE

Specifies the new transaction state that selected transactions will be changed to. This qualifier is required and new state value must be specified.

Value of `new_state` may be one of the following:

- ABORT
- COMMIT
- DONE
- EXCEPTION
- PRI_DONE
- DEFER

Note that one cannot always change a transaction's state from one legitimate transaction state to another. Some state changes are not valid. The following table shows state changes that are valid.

Table 9–22 Valid Transaction State Changes

Current State	NEW STATE					
	COMMIT	ABORT	EXCEPTION	DEFER	PRI_DONE	DONE
SENDING		YES				
VOTED	YES	YES				
COMMIT			YES			YES
EXCEPTION	YES					YES
PRI_DONE				YES		YES
DEFER					YES	

/NODE[=node-list]

/NODE=default-node (D)

Specifies that the command is executed on all nodes specified in `node-list`. If `node-list` is omitted, the command is executed only on the node where the command was issued.

/OUTPUT[=filespec]

/OUTPUT=stdout (D)

Specifies that the resulting information is written to the file `filespec`. If `/OUTPUT` or `filespec` is omitted, the standard or default output is used.

/PARTITION

/PARTITION=partition_name

Specifies the name of a partition within which all transactions are running. A partition name must be supplied.

Use `SHOW PARTITION` to view the names of the currently active partitions.

/SINCE[=date]

Selects only those transactions whose timestamp is after the specified date. Default is the current date.

/STATE=current_state

Selects a particular transaction or a set of transactions that are in the specified `current_state` transaction state. This qualifier is required and the `current_state` value must be specified.

SET TRANSACTION

Value of `current_state` may be one of the following:

SENDING
VOTED
COMMIT
EXCEPTION
PRI_DONE
DEFER

Use the `SHOW TRANSACTION` or `DUMP JOURNAL` commands to help you find the current state of a particular transaction. Once a transaction is in the `pri_done` state, that transaction has already been deleted from memory, so you must look in the journal (using the `DUMP JOURNAL` command) to see the details of that transaction.

/USER[=`user-id`]
/USER=all users (D)

Allows you to select transactions that were initiated by a client process.

If `/USER` is not specified, transactions for all users are affected.

Related commands

- `SHOW TRANSACTION`
- `DUMP JOURNAL`

Examples

```
RTR> SET TRANSACTION "50d01f10,0,0,0,0,2166,522b2001" -  
_RTR> /NEW=ABORT /STATE=SENDING /PART=DB_PART
```

Abort this specified transaction running in the `DB_PART` partition.

```
RTR> SET TRANSACTION /NEW=ABORT /STATE=VOTED /PART=DB_PART
```

Abort all transactions that are in `VOTED` transaction state and are running in `DB_PART` partition, in the `RTR$DEFAULT-FACILITY` facility.

For more examples, refer to Chapter 4, Transaction Management.

SHOW CHANNEL

The **SHOW CHANNEL** command shows the names and state of channels that have been opened using the CLI API.

Format

```
SHOW CHANNEL [channel-name]
```

Command Qualifiers

```
/ALL_WINDOWS  
/CLUSTER  
/NODE[=node-list]  
/OUTPUT[=filespec]
```

Defaults

```
/NOALL_WINDOWS  
/NOCLUSTER  
/NODE=default-node  
/OUTPUT=stdout
```

Description

The **SHOW CHANNEL** command shows the channel type (client or server), the channel name and owner process-id for channels opened using the CLI API.

Parameters

channel-name

Specifies the name of the channel to be displayed. `channel-name` can contain wildcards. If `channel-name` is omitted, all declared channels for this window (terminal or virtual terminal) are displayed.

Qualifiers

/ALL_WINDOWS

/NOALL_WINDOWS

Specifies that channels opened in all windows (terminals or virtual terminals) are shown.

/CLUSTER

/NOCLUSTER (D)

Specifies that the command is executed on all the nodes in the cluster.

If neither `/NODE` nor `/CLUSTER` is specified, the command is executed on the nodes specified by the latest `SET ENVIRONMENT` command. If no `SET ENVIRONMENT` command has been entered, the command is executed only on the node where the command was issued.

SHOW CHANNEL

Note

In environments that do not support remote command capability, the /CLUSTER qualifier causes the relevant command to be executed on the local node only.

/NODE[=node-list]

/NODE=default-node (D)

Specifies that the command is executed on all nodes specified in node-list. If node-list is omitted, the command is executed only on the node where the command was issued.

/OUTPUT[=filespec]

/OUTPUT=stdout (D)

Specifies that the resulting information is written to the file filespec. If /OUTPUT or filespec is omitted, the standard or default output is used.

Related commands

- CALL RTR_OPEN_CHANNEL
- CALL RTR_CLOSE_CHANNEL

Examples

```
RTR> SHOW CHANNEL/ALL_WINDOWS ❶
```

Channel type	Channel name	(Owner pid)
server	RTR\$DEFAULT_CHANNEL	(28879) ❷
client	CLI_CHN	(28879) ❸
client	CLI_CHN2	(26225) ❹

- ❶ Displays information about all declared channels.
- ❷ The channel called RTR\$DEFAULT_CHANNEL is open as a server channel.
- ❸ The channel called CLI_CHN is open as a client channel.
- ❹ The channel called CLI_CHN2 is open as a client channel, and has been opened by another process (in another window).

SHOW CLIENT

The **SHOW CLIENT** command displays information about client channels.

Format

SHOW CLIENT

Command Qualifiers	Defaults
/CLUSTER	/NOCLUSTER
/FACILITY[=facility_name]	/FACILITY=""
/FULL	None
/IDENTIFICATION=process-id	/NOIDENTIFICATION
/NODE[=node-list]	/NODE=default-node
/OUTPUT[=filespec]	/OUTPUT=stdout

Description

The **SHOW CLIENT** command displays information about client channels.

Information such as PID, key range, state, event mask and event name are displayed.

Qualifiers

/CLUSTER

/NOCLUSTER (D)

Specifies that the command is executed on all the nodes in the cluster.

If neither **/NODE** nor **/CLUSTER** is specified, the command is executed on the nodes specified by the latest **SET ENVIRONMENT** command. If no **SET ENVIRONMENT** command has been entered, the command is executed only on the node where the command was issued.

Note

In environments that do not support remote command capability, the **/CLUSTER** qualifier causes the relevant command to be executed on the local node only.

/FACILITY

/FACILITY="" (D)

Specifies the facility name for which information should be displayed.

SHOW CLIENT

By default, information is displayed for all facilities.

/FULL

none (D)

Specifies a detailed listing of client information.

/IDENTIFICATION=process-id

/NOIDENTIFICATION (D)

Specifies the PID of the process for which information is displayed. The default (/NOIDENTIFICATION) displays information for all clients.

/NODE[=node-list]

/NODE=default-node (D)

Specifies that the command is executed on all nodes specified in node-list. If node-list is omitted, the command is executed only on the node where the command was issued.

/OUTPUT[=filespec]

/OUTPUT=stdout (D)

Specifies that the resulting information is written to the file filespec. If /OUTPUT or filespec is omitted, the standard or default output is used.

Examples

```
RTR> SHOW CLIENT/FULL ❶  
  
Process-id:      9234          Facility:      TEST43 ❷  
Channel:        500           Flags:        CLI ❸  
State:          declared      rcpnam:      "V3TEST" ❹  
User Events:    255           RTR Events:   0 ❺
```

- ❶ Shows the client in detail.
- ❷ Client's process ID and facility name.
- ❸ Client's channel ID and the flags set when the channel was opened.
- ❹ Channel state and recipient name for events.
- ❺ User events and RTR events subscribed to.

SHOW CONNECTIONPOOL

The **SHOW CONNECTIONPOOL** command displays information about connectionpool instances.

Use of this command requires the RTR Java Toolkit.

Format

```
SHOW CONNECTIONPOOL [connectionpool_name]
```

Command Qualifiers

```
/NODE[=node-list]  
/OUTPUT[=filespec]
```

Defaults

```
/NODE=default-node  
/OUTPUT=stdout
```

Description

The **SHOW CONNECTIONPOOL** command displays information about connectionpool instances in the RTR ACP.

See the related commands and the RTR Glossary in the *HP Reliable Transaction Router Getting Started* for additional information on this and other Java-related commands.

Parameters

connectionpool_name

Specifies the name of the connectionpool to be displayed. If *connectionpool_name* is omitted, all configured connectionpools are displayed.

Qualifiers

/NODE[=node-list]

/NODE=default-node

Execute the command on all nodes specified in *node-list*. If *node-list* is omitted, the command is executed only on the node where the command was issued.

/OUTPUT[=filespec]

/OUTPUT=stdout

Writes the resulting information to the file *filespec*. If */OUTPUT* or *filespec* is omitted, then standard or default output is used.

SHOW CONNECTIONPOOL

Related Commands

- CREATE CONNECTIONPOOL
- SHOW DATASOURCE
- SHOW SERVICEPROVIDER

The following example shows the result of executing a SHOW CONNECTIONPOOL command.

Examples

```
RTR> SHOW CONNECTIONPOOL ❶  
  
ConnectionPool on node NodeA in group "JavaRTRSample" at Tue Oct 15 18:54:04 2002  
  
ConnectionPool Name      : myconnection ❷  
XA Driver Class Name    : com.ddtek.jdbcx.sequelink.SequeLinkDataSource ❸  
JNDI Name               : rtrcp ❹  
ServiceProvider Name    : myservice ❺  
XA Driver Properties    : ❻  
Server Name             : localhost ❼  
Database Name           : RTRCS ❽  
User                    : username ❾
```

- ❶ Shows information about all defined connectionpools.
- ❷ Name of the ConnectionPool.
- ❸ Full name of the XA driver class.
- ❹ Name of the ConnectionPool known to the JNDI.
- ❺ Name of the ServiceProvider.
- ❻ Properties of the XA driver, if any.
- ❼ Name of the server.
- ❽ Name of the database.
- ❾ Name of the user.

SHOW DATASOURCE

The **SHOW DATASOURCE** command displays information about datasource instances.

Use of this command requires the RTR Java Toolkit.

Format

```
SHOW DATASOURCE [datasource_name]
```

Command Qualifiers

```
/NODE[=node-list]  
/OUTPUT[=filespec]
```

Defaults

```
/NODE=default-node  
/OUTPUT=stdout
```

Description

The **SHOW DATASOURCE** command displays information about datasource instances in the RTR ACP.

See the related commands and the RTR Glossary in the *HP Reliable Transaction Router Getting Started* for additional information on this and other Java-related commands.

Parameters

datasource_name

Specifies the name of the datasource to be displayed. If *datasource_name* is omitted, all configured datasources are displayed.

Qualifiers

/NODE[=node-list]

/NODE=default-node

Execute the command on all nodes specified in *node-list*. If *node-list* is omitted, the command is executed only on the node where the command was issued.

/OUTPUT[=filespec]

/OUTPUT=stdout

Writes the resulting information to the file *filespec*. If */OUTPUT* or *filespec* is omitted, then standard or default output is used.

SHOW DATASOURCE

Related Commands

- CREATE DATASOURCE
- SHOW CONNECTIONPOOL
- SHOW SERVICEPROVIDER

The following example shows the result of executing the SHOW DATASOURCE command.

Examples

```
RTR> SHOW DATASOURCE ❶  
  
DataSource on node NodeA in group "JavaRTRSample" at Tue Oct 15 18:52:54 2002  
  
DataSource Name      :: myDataSource ❷  
JNDI Name           :: rtrDS ❸  
ConnectionPool Name :: myconnection ❹  
ServiceProvider Name :: myservice ❺  
RTR>
```

- ❶ Shows information about all defined datasources.
- ❷ Name of the Datasource.
- ❸ Name of the JNDI.
- ❹ Name of the ConnectionPool.
- ❺ Name of the ServiceProvider

SHOW DISPLAY

The **SHOW DISPLAY** command shows which items were displayed by the most recently issued **MONITOR** command or **DISPLAY** commands.

Note

This command is not available in the RTR web browser interface.

Format

SHOW DISPLAY

Command Qualifiers

/ALL
 /OUTPUT[=filespec]
 /X[=column]
 /Y[=row]

Defaults

/ALL
 /OUTPUT=stdout
 Column of previous item
 Next free row

Description

The **SHOW DISPLAY** command shows which items were displayed by the most recently issued **MONITOR** command. These may have been read in from a display file using the **MONITOR filespec** command, or entered interactively using **DISPLAY** commands.

The item definitions are shown in **DISPLAY** command format. Use the command **SHOW DISPLAY/OUTPUT=filespec** to create new monitor files.

Qualifiers

/ALL (D)

/NOALL

Specifies that all monitored items are shown.

/OUTPUT[=filespec]

/OUTPUT=stdout (D)

Specifies that the resulting information is written to the file **filespec**. If **/OUTPUT** or **filespec** is omitted, the standard or default output is used.

/X=column /Y=row

Specifies that the single item in position (column,row) is shown.

SHOW DISPLAY

Related commands

- MONITOR
- DISPLAY NUMERIC
- DISPLAY BAR
- DISPLAY TEXT

Examples

```
RTR> MON CALLS ❶
RTR> SHOW DISPLAY/ALL ❷

DISPLAY TEXT "RTR api calls, Node: $node_name , - ❸
             PID: $process_id, Process name: -ALL-" -
             /X=1 /Y=1 -
             /BOLD="1"
             .
             .
             .
DISPLAY NUMERIC "rtr_open_channel_succ" -
             /X=1 /Y=5 -
             /BLANK -
             /LABEL=" rtr_open_channel " -
             /WIDTH=9
             .
             .
             .
```

- ❶ Displays the CALLS monitor picture.
- ❷ Shows all the items contained in the monitor picture.
- ❸ Displays items in DISPLAY command format. See the relevant DISPLAY commands for a description of the various qualifiers.

See Section A.1, Interactive Definition of a Monitor Picture, for an example of how to use the SHOW DISPLAY command.

SHOW ENVIRONMENT

The **SHOW ENVIRONMENT** command shows the default nodes used for remote command execution.

Note

This command is not available in the RTR web browser interface.

Format

SHOW ENVIRONMENT

Description

The SHOW ENVIRONMENT command shows which nodes are used by default for remote command execution.

Related commands

- SET ENVIRONMENT

Examples

```
RTR> SET ENVIRONMENT/NODE=(FE2,FE3) ❶  
RTR> SHOW ENVIRONMENT ❷  
%RTR-S-COMARESEN, commands sent by default to node FE2 ❸  
%RTR-S-COMARESEN, commands sent by default to node FE3
```

- ❶ Sets the command environment so that subsequent commands will be executed on nodes FE2 and FE3.
- ❷ Shows which nodes are selected.
- ❸ Displays the RTR-S-COMARESEN message for each selected node.

SHOW FACILITY

SHOW FACILITY

The **SHOW FACILITY** command shows the names, configuration, and status of one or more facilities.

Format

```
SHOW FACILITY [facility-name]
```

Command Qualifiers

```
/BALANCE  
/CLUSTER  
/CONFIGURATION  
/COUNTER[=counter-name]  
/FULL  
/LINKS/BRIEF  
/NODE[=node-list]  
/OUTPUT[=filespec]  
/STATE
```

Defaults

```
/NOBALANCE  
/NOCLUSTER  
/NOCONFIGURATION  
/NOCOUNTER  
/NOFULL  
/NOLINKS/NOBRIEF  
/NODE=default-node  
/OUTPUT=stdout  
/NOSTATE
```

Description

The **SHOW FACILITY** command shows the names, configuration and status of facilities on the node where the command is executed. If no qualifiers are used, only the facility name or names and the roles in the facility on the node are displayed.

Parameters

facility-name

Specifies the name of the facility you want to display. Facility-name may contain wildcards (* and %), in which case all matching facilities will be displayed. UNIX users can also employ the ? single-character wildcard. If facility-name is omitted, all configured facilities are displayed.

Qualifiers

/BALANCE

/NOBALANCE (D)

Specifies that the load balancing status of the facility is also displayed. See Section 2.8, Router Load Balancing for details of load balancing.

/CLUSTER
/NOCLUSTER (D)

Specifies that the command is executed on all the nodes in the cluster.

If neither **/NODE** nor **/CLUSTER** is specified, the command is executed on the nodes specified by the latest **SET ENVIRONMENT** command. If no **SET ENVIRONMENT** command has been entered, the command is executed only on the node where the command was issued.

Note

In environments that do not support remote command capability, the **/CLUSTER** qualifier causes the relevant command to be executed on the local node only.

/CONFIGURATION
/NOCONFIGURATION (D)

Specifies that the facility configuration is to be displayed. The configuration information indicates the role of the node where the command is executed, and whether:

- Router callout servers or backend callout servers have been configured
- Load balancing has been configured
- Quorum check is being handled on this node
- Reply consistency check for replayed messages is enabled

/COUNTER[=counter-name]
/NOCOUNTER (D)

Specifies that the facility counters are displayed. Counter-name is the name of the counter. If counter-name is omitted, all counters are displayed. Counter-name may contain wildcard characters.

/FULL
/NOFULL (D)

Equivalent to specifying **/CONFIGURATION**, **/STATE** and **/LINK**.

/LINKS
/NOLINKS (D)

Lists all links to connected nodes in the facility (including the node where the command is executed).

SHOW FACILITY

If the `/BRIEF` qualifier is used, `SHOW FACILITY/LINKS/BRIEF`, the facility name is displayed, followed by one or more lines showing the name of each link followed by the link's roles and their status in parentheses.

```
RTR> SHOW FACILITY/LINKS/BRIEF
```

```
Facilities on node NODEA at Wed Nov 03 11:115:47 1999
```

```
BOVRIL (Backend coordinator, Router quorate, Frontend connected>
```

Backend nodes can be either connected, quorate, or coordinator. Router nodes can be either connected, quorate, or current (current is only seen from a frontend).

If the `/BRIEF` qualifier is not used, the following information is shown for each link:

- Whether the node on this link is active as frontend, router or backend roles.
- What kind link is active, that is:
 - frontend to router
 - router to frontend
 - router to backend
 - backend to router
- Whether the router and backend roles are quorate
- Whether the router role is the current router for the frontend
- Whether the backend role is acting as a load balancing coordinator

`/NODE[=node-list]`

`/NODE=default-node (D)`

Specifies that the command is executed on all nodes specified in `node-list`. If `node-list` is omitted, the command is executed only on the node where the command was issued.

`/OUTPUT[=filespec]`

`/OUTPUT=stdout (D)`

Specifies that the resulting information is written to the file `filespec`. If `/OUTPUT` or `filespec` is omitted, the standard or default output is used.

`/STATE`

`/NOSTATE(D)`

Specifies that the state of the facility is displayed.

On nodes having a backend or router role, the quorum status is shown. Also, the current quorum threshold is shown (default quorum value is shown as zero), and the minimum broadcast rate (if it has been set).

On a frontend, this qualifier can be used to find out whether the node is currently connected to a router.

Related commands

- CREATE FACILITY
- DELETE FACILITY
- SHOW LINK

Examples

```
RTR> SHOW FACILITY/FULL/NODE=BRONZE ❶

Facility:          FUNDS_TRANSFER ❷
Configuration:-    ❸

Frontend:          no   Router:          yes   Backend:          yes
                   Router call-out:      no   Backend call-out: no
                   Load balance:         no   Quorum-check off: no

State:-           ❹

FE -> TR:          unused   Router quorate:   yes   Backend quorate:  yes
                   Quorum threshold:     0   Min broadcast rate: 0

Links:-           ❺

Link to:                          bronze
Frontend:          no   Router:          yes   Backend:          yes
Router -> Frontend:no   Frontend -> Router: no
                   Backend -> Router:   yes   Router -> Backend: yes
                   Router quorate:     yes   Backend quorate:  yes
                   Router current:      no   Backend coordinator:yes

Link to:                          airola ❻
Frontend:          yes   Router:          no   Backend:          no
Router -> Frontend:yes   Frontend -> Router: no
                   Backend -> Router:   no   Router -> Backend: no
                   Router quorate:     no   Backend quorate:  no
                   Router current:      no   Backend coordinator: no
```

SHOW FACILITY

- 1 Shows all facilities in detail.
- 2 Facility's name.
- 3 Facility's configured roles on this node. In this example, the node is a router and a backend; load balancing, router callouts and backend callouts are not enabled.
- 4 Facility's state. The router and backend roles are quorate. (Quorate means that this node's view of the availability of the other nodes in the configuration matches that of the other backends and routers. A facility that is not in the quorate state is effectively unusable.) The quorum threshold is at the default (zero) and no minimum broadcast rate has been set.
- 5 Facility's links. The first link shown (to node bronze i.e. itself) shows that it is a router, connected to the backend, and the router is quorate. The router is not current because there is no frontend on this connection. The link is also a backend, connected to the router, and this backend is quorate. This backend would also be the backend coordinator if load balancing was enabled.
- 6 Second link shown (to node airola) shows that it is a frontend, and is a frontend to router connection.

```
RTR> SHOW FACILITY/BALANCE
```

```
Facilities:
```

```
Facility:          RTR$DEFAULT_FACILITY
```

```
Load:-
```

Frontends connected:	1	Frontends allowed:	1
Load coordinator:	yes	Quorate routers:	1
Total Frontends:	1	Current Credit:	1
FE -> TR:	-		

This display shows the load balancing status. This node is the current load coordinator.

SHOW JOURNAL

The **SHOW JOURNAL** command displays information about current RTR journal files.

Format

SHOW JOURNAL

Command Qualifiers

/CLUSTER
/FILENAMES
/FULL
/NODE[=node-list]
/OUTPUT[=filespec]

Defaults

/NOCLUSTER
/NOFILENAMES
/NOFULL
/NODE=default-node
/OUTPUT=stdout

Description

The SHOW JOURNAL command shows the disks where the RTR journal files reside, and (optionally) the maximum and allocated number of blocks for each journal file and the journal file name.

Qualifiers

/CLUSTER

/NOCLUSTER (D)

Specifies that the command is executed on all the nodes in the cluster.

If neither /NODE nor /CLUSTER is specified, the command is executed on the nodes specified by the latest SET ENVIRONMENT command. If no SET ENVIRONMENT command has been entered, the command is executed only on the node where the command was issued.

Note

In environments that do not support remote command capability, the /CLUSTER qualifier causes the relevant command to be executed on the local node only.

/FILENAMES

/NOFILENAMES (D)

/FILE adds the journal file names to the display.

SHOW JOURNAL

/FULL

/NOFULL (D)

/FULL adds to the display the maximum and allocated number of blocks for each journal file.

/NODE[=node-list]

/NODE=default-node (D)

Specifies that the command is executed on all nodes specified in node-list. If node-list is omitted, the command is executed only on the node where the command was issued.

/OUTPUT[=filespec]

/OUTPUT=stdout (D)

Specifies that the resulting information is written to the file filespec. If /OUTPUT or filespec is omitted, the standard or default output is used.

Related commands

- CREATE JOURNAL
- DELETE JOURNAL
- INITIALIZE JOURNAL
- MONITOR JOURNAL
- MONITOR RECOVERY

Examples

```
RTR> SHOW JOURNAL/FULL/FILENAMES ❶  
  
RTR journal:-  
  ❷  
Disk(1):  /dev/rz3a      ❸      Blocks: 1500 Allocated: 1502 Maximum: 3000  
File(1):  /dev/rz3a /rtrjnl/SYSTEM/BRONZE.J01 ❹  
Disk(2):  /dev/rz2c      ❸      Blocks: 1500 Allocated: 1502 Maximum: 3000  
File(2):  /dev/rz2c /usr/users/rtrjnl/SYSTEM/BRONZE.J11 ❺
```

- ❶ Shows the disks used for RTR's recovery journal and the file names
- ❷ Shows two disks are currently in use
- ❸ Shows device name

SHOW JOURNAL

- ④ Shows file size in blocks
- ⑤ Shows allocated file size in blocks
- ⑥ Shows maximum file size in blocks
- ⑦ Filename

SHOW KEY

SHOW KEY

The **SHOW KEY** command displays the key definitions created by the **DEFINE /KEY** command.

Format

```
SHOW KEY [key-name]
```

Command Qualifiers

```
/ALL  
/FULL  
/OUTPUT[=filespec]  
/IF_STATE
```

Defaults

```
/NOALL  
/NOFULL  
/OUTPUT=stdout  
/NOIF_STATE
```

Description

The **SHOW KEY** command shows the key definitions created by the **DEFINE /KEY** command.

Parameters

key-name

Specifies the name of the key whose definition you want displayed. See the description of the **DEFINE /KEY** command for a list of the valid key names.

Qualifiers

/ALL

/NOALL (D)

Requests that all key definitions in the current state be displayed. You can use the **/IF_STATE** qualifier to request key definitions in other states. Do not specify a key name with the **/ALL** qualifier. If no state is specified, all key definitions in the current state are displayed.

/FULL

/NOFULL (D)

Requests that all qualifiers associated with a definition are displayed. By default, only the state of the definition and the definition itself are displayed.

/OUTPUT[=filespec]

/OUTPUT=stdout (D)

Specifies that the resulting information is written to the file **filespec**. If **/OUTPUT** or **filespec** is omitted, the standard or default output is used.

/IF_STATE=state-name
/NOIF_STATE (D)

Specifies the name of a state for which the specified key definitions are displayed. State names can be any appropriate alphanumeric string. State names are created with the **DEFINE /KEY** command. If you omit the **/IF_STATE** qualifier or use **/NOIF_STATE**, key definitions in the current state are displayed.

Related commands

- **DEFINE /KEY**

Examples

```
RTR> SHOW KEY/FULL
DEFAULT PF1 defined as ""
DEFAULT KP0 defined as "MONITOR/RESUME"
DEFAULT KP2 defined as "SCROLL DOWN 1"
DEFAULT KP4 defined as "SCROLL LEFT 1"
DEFAULT KP5 defined as "SCROLL HOME"
DEFAULT KP6 defined as "SCROLL RIGHT 1"
DEFAULT KP8 defined as "SCROLL UP 1"
GOLD KP2 defined as "SCROLL DOWN 10"
GOLD KP4 defined as "SCROLL LEFT 10"
GOLD KP6 defined as "SCROLL RIGHT 10"
GOLD KP8 defined as "SCROLL UP 10"
```

SHOW LINK

SHOW LINK

The **SHOW LINK** command displays the configuration and status of the links to other nodes.

Format

```
SHOW LINK [node-name]
```

Command Qualifiers

```
/CLUSTER  
/COUNTER[=counter-name]  
/FACILITY  
/FULL  
/NODE[=node-list]  
/OUTPUT[=filespec]  
/STATE
```

Defaults

```
/NOCLUSTER  
/NOCOUNTER  
/NOFACILITY  
/NOFULL  
/NODE=default-node  
/OUTPUT=stdout  
/NOSTATE
```

Description

The **SHOW LINK** command shows the configuration and status of the links to RTR nodes. If no qualifiers are given, a brief display of the links is shown.

Parameters

node-name

Specifies the name of a node; the parameters for the link to this node are displayed. Node-name may contain wildcards (* and %), in which case all matching links are displayed. If node-name is omitted, all known links are displayed.

Qualifiers

/CLUSTER

/NOCLUSTER (D)

Specifies that the command is executed on all the nodes in the cluster.

If neither **/NODE** nor **/CLUSTER** is specified, the command is executed on the nodes specified by the latest **SET ENVIRONMENT** command. If no **SET ENVIRONMENT** command has been entered, the command is executed only on the node where the command was issued.

Note

In environments that do not support remote command capability, the /CLUSTER qualifier causes the relevant command to be executed on the local node only.

/COUNTER[=counter-name]

/NOCOUNTER (D)

Specifies that the link counters are also to be displayed. Counter-name is the name of the counter to be displayed. If counter-name is omitted then all counters will be displayed. Counter-name may contain wild card characters.

/FACILITY

/NOFACILITY (D)

Specifies that the names of facilities using the link are also displayed.

/FULL

Equivalent to specifying /FACILITY/STATE.

/NODE[=node-list]

/NODE=default-node (D)

Specifies that the command is executed on all nodes specified in node-list. If node-list is omitted, the command is executed only on the node where the command was issued.

/OUTPUT[=filespec]

/OUTPUT=stdout (D)

Specifies that the resulting information is written to the file filespec. If /OUTPUT or filespec is omitted, the standard or default output is used.

/STATE

/NOSTATE (D)

Specifies that a detailed status of the specified link is displayed.

Related commands

- SET LINK
- CREATE FACILITY
- SHOW FACILITY/LINK

SHOW LINK

Example

```
RTR> SHOW LINK/FULL IRON
```

```
Links:
```

```
To Node:                iron      Address:                iron.zuo.dec.com
```

```
Status:-
```

```
Outgoing message sequence nr:    22      Incoming message sequence nr:    22
Current receive buffer size:    2048     Current transmit buffer size:    2048
Current number of link users:    1        Write buffer timed out:          no
Write buffer full, may be sent:  no      Write buffer allocated:          yes
I/O error detected in write:    no      I/O error detected in read:     no
Pipe temporarily blocked:       no      Connection broken:               no
Write issued, not completed:    no      Read is pending:                 yes
Node initiated the connection:  yes     Connection established:          yes
Connection in progress:        no      Node is configured:              yes
Link is in disabled state:     no      Link may be suspect:             no
```

```
Facilities:-
```

```
In facility:                steve2
```

```
Frontend:                    no      Router:                      yes   Backend:                      no
Router -> Frontend:          no      Frontend -> Router:          yes
Backend -> Router:          no      Router -> Backend:          no
Router quorate:              no      Backend quorate:            no
Router current:              yes     Backend coordinator:        no
```

This example shows the:

- Name and network address of the partner node.
- Link status.
- Name of facility using this link and how the link is used in the facility.

SHOW LOG

The **SHOW LOG** command displays the names of the current log files.

Format

SHOW LOG

Command Qualifiers

/CLUSTER

/NODE[=node-list]

/OUTPUT[=filespec]

Defaults

/NOCLUSTER

/NODE=default-node

/OUTPUT=stdout

Description

The SHOW LOG command shows the names of the current RTR log files as defined with the SET LOG command.

Qualifiers

/CLUSTER

/NOCLUSTER (D)

Specifies that the command is executed on all the nodes in the cluster.

If neither /NODE nor /CLUSTER is specified, the command is executed on the nodes specified by the latest SET ENVIRONMENT command. If no SET ENVIRONMENT command has been entered, the command is executed only on the node where the command was issued.

Note

In environments that do not support remote command capability, the /CLUSTER qualifier causes the relevant command to be executed on the local node only.

/NODE[=node-list]

/NODE=default-node (D)

Specifies that the command is executed on all nodes specified in node-list. If node-list is omitted, the command is executed only on the node where the command was issued.

SHOW LOG

/OUTPUT[=filespec]

/OUTPUT=stdout (D)

Specifies that the resulting information is written to the file filespec. If /OUTPUT or filespec is omitted, the standard or default output is used.

Related commands

- SET LOG

Example

```
RTR> SHOW LOG ❶
```

```
Messages not being sent to operator console ❷
```

```
Log file[1]: /usr/users/someone/rtr_logfile.log ❸
```

- ❶ Shows where RTR log messages are currently written
- ❷ Shows log messages are currently not being sent to the operator log.
- ❸ Shows log messages are currently being written to file rtr_logfile.log.

SHOW MODE

The **SHOW MODE** command displays the current RTR mode.

Format

SHOW MODE

Command Qualifiers

/CLUSTER

/NODE[=node-list]

/OUTPUT[=filespec]

Defaults

/NOCLUSTER

/NODE=default-node

/OUTPUT=stdout

Description

The SHOW MODE command shows the currently running user group for RTR. For nogroup (system) mode, a null group name is displayed. SET MODE command for further information about modes.

Qualifiers

/CLUSTER

/NOCLUSTER (D)

Specifies that the command is executed on all the nodes in the cluster.

If neither /NODE nor /CLUSTER is specified, the command is executed on the nodes specified by the latest SET ENVIRONMENT command. If no SET ENVIRONMENT command has been entered, the command is executed only on the node where the command was issued.

Note

In environments that do not support remote command capability, the /CLUSTER qualifier causes the relevant command to be executed on the local node only.

/NODE[=node-list]

/NODE=default-node (D)

Specifies that the command is executed on all nodes specified in node-list. If node-list is omitted, the command is executed only on the node where the command was issued.

SHOW MODE

/OUTPUT[=filespec]

/OUTPUT=stdout (D)

Specifies that the resulting information is written to the file filespec. If /OUTPUT or filespec is omitted, the standard or default output is used.

Related commands

- SET MODE

Examples

```
RTR> SHOW MODE
```

```
Group name is "develop"
```

SHOW NODE

The **SHOW NODE** command shows the request_info cache lifetime, the router response timeout, the priority switch delay, the node network status, the autoisolation state, the node inactivity timer, wait TR ok timer, the detection interval and Cluster Configuration.

Format

SHOW NODE

Command Qualifiers

/CLUSTER

/NODE[=node-list]

/OUTPUT[=filespec]

Defaults

/NOCLUSTER

/NODE=default-node

/OUTPUT=stdout

Description

The SHOW NODE shows the network status, the autoisolation state (enabled or disabled), the node inactivity timer, the detection interval, and the request_info cache lifetime and wait TR ok timer and Cluster Configuration.

Note

The Cluster Configuration information is applicable only for HP-UX and Linux I64 platforms.

Qualifiers

/CLUSTER

/NOCLUSTER (D)

Specifies that the command is executed on all the nodes in the cluster.

If neither /NODE nor /CLUSTER is specified, the command is executed on the nodes specified by the latest SET ENVIRONMENT command. If no SET ENVIRONMENT command has been entered, the command is executed only on the node where the command was issued.

SHOW NODE

Note

In environments that do not support remote command capability, the /CLUSTER qualifier causes the relevant command to be executed on the local node only.

/NODE[=node-list]

/NODE=default-node (D)

Specifies that the command is executed on all nodes specified in node-list. If node-list is omitted, the command is executed only on the node where the command was issued.

/OUTPUT[=filespec]

/OUTPUT=stdout (D)

Specifies that the resulting information is written to the file filespec. If /OUTPUT or filespec is omitted, the standard or default output is used.

Related commands

- SET NODE/ISOLATE
- SET LINK

Examples

```
RTR> SHOW NODE ❶
Node properties:

Network state:           enabled ❷
Auto isolation:         disabled ❸
Inactivity timer/s:     60 ❹
Detection interval:     0 ❺
Info cache lifetime:   20 ❻
Router response timeout: 30 ❼
Priority switch delay:  1800 ❽
Wait TR ok timer:      0 ❾
Cluster Configuration:
  Member Nodes: bng100, bng101
  Cluster Lock Disk: /dev/vg00/lvol3 ❿
```

- ❶ SHOW NODE command
- ❷ Shows network status
- ❸ Shows auto isolation state (enabled or disabled)
- ❹ Shows inactivity timer value in seconds
- ❺ Shows detection interval in seconds
- ❻ Shows cache lifetime in seconds
- ❼ Shows router response timeout in seconds
- ❽ Shows priority switch delay in seconds
- ❾ Shows Wait Tr ok timer
- ❿ Shows Cluster member nodes and Cluster node locks disk location

SHOW PARTITION

SHOW PARTITION

The **SHOW PARTITION** command displays server data partition information.

Format

SHOW PARTITION

Command Qualifiers	Defaults
/BACKEND	/NOBACKEND
/CLUSTER	/NOCLUSTER
/FACILITY[=facility-name]	/FACILITY=""
/FULL	/NOFULL
/NODE[=node-list]	/NODE=default-node
/OUTPUT[=filespec]	/OUTPUT=stdout
/ROUTER	/NOROUTER

Description

The **SHOW PARTITION** command displays information about key range partitions, their states, and current transaction activity. This information is useful for diagnosing bottlenecks or partition difficulties in RTR. For more details, also see Section 2.16.

The State field of **SHOW PARTITION /BACKEND** can display the following values:

Table 9–23 Key-Range or Partition States

State	Meaning
wt_tr_ok	Server is waiting for routers to accept it
wt_quorum	Server is waiting for backend to be quorate
lcl_rec	Local recovery
lcl_rec_fail	Primary server waiting for access to a restart journal
lcl_rec_icpl	Getting next journal to recover from
lcl_rec_cpl	Processed all journals for local recovery
shd_rec	Shadow recovery
shd_rec_fail	Shadow server waiting for access to a restart journal

(continued on next page)

Table 9–23 (Cont.) Key-Range or Partition States

State	Meaning
shd_rec_icpl	Shadow getting next journal to recover from
shd_rec_cpl	Processed all journals for shadow recovery
catchup	Secondary is catching up with primary
standby	Server is declared as standby
active	Server is active
pri_act	Server is active as primary shadow
sec_act	Server is active as secondary shadow
remember	Primary is running without shadow secondary

The State field of SHOW PARTITION /ROUTER can display the following values:

Table 9–24 Router Partition States

State	Meaning
BLOCKED	Key range is recovering or awaiting journal access
ACTIVE	Primary server is ready to accept transactions
CATCHUP	Secondary server is catching up with primary
TAKEOVR	Standby take-over is in progress
LAGGING	Secondary is ready, primary is still recovering

Qualifiers

/BACKEND

/NOBACKEND (D)

Displays information about backend partitions; it shows the partition state and low and high bounds. /BACKEND with /FULL provides more detailed information for a partition, giving the current queue depth (transactions active) on a partition. This is useful for determining whether a server is processing transactions correctly.

- Last Rcvy BE: shows from which node recovery information may be fetched.
- Txns Rcvrd: shows the number of transactions actually recovered.

The default is to output brief router and backend information.

SHOW PARTITION

/CLUSTER

/NOCLUSTER (D)

Specifies that the command is executed on all the nodes in the cluster.

If neither **/NODE** nor **/CLUSTER** is specified, the command is executed on the nodes specified by the latest **SET ENVIRONMENT** command. If no **SET ENVIRONMENT** command has been entered, the command is executed only on the node where the command was issued.

Note

In environments that do not support remote command capability, the **/CLUSTER** qualifier causes the relevant command to be executed on the local node only.

/FACILITY

/FACILITY="*" (D)

Specifies the facility name for which information should be displayed.

By default, information is displayed for all facilities.

/FULL

/NOFULL (D)

Gives a detailed listing of server partition information.

The following items are displayed:

- Key segment low and high bounds
- Counts of the active and free servers bound to the partition
- Counts of the active and recovered transactions for the partition
- The state of transaction presentation - one of active, suspended or suspending
- The current failover policy - one of `fail_to_standby`, `fail_to_shadow` or `pre_v32_compatibility`

The **SHOW PARTITION** command displays callout server data as backend server data because a callout server uses server, not router, data structures. A callout server actually runs on the router identified for its facility.

/NODE[=node-list]

/NODE=default-node (D)

Specifies that the command is executed on all nodes specified in node-list. If node-list is omitted, the command is executed only on the node where the command was issued.

/OUTPUT[=filespec]

/OUTPUT=stdout (D)

Specifies that the resulting information is written to the file filespec. If /OUTPUT or filespec is omitted, the standard or default output is used.

/ROUTER

/NOROUTER (D)

Displays information about router partitions; it shows the partition state and partition low and high bounds. It can be used to quickly determine the current primary node for a given partition. Using /ROUTER with /FULL provides more detailed information, such as the main, shadow and standby servers for the partitions, as seen from the router.

Partition bounds are shown as ASCII characters if there is a translation, otherwise as hexadecimal digits. Only the least significant 4 bytes are shown.

Examples

The following example shows the /FULL output of the SHOW PARTITION command in a shadow configuration.

```
RTR> SHOW PARTITION/FULL
```

```
Router partitions on node mspl01 in group "rtrlkg" at Tue Oct 15 13:40:53 2002
```

```
Backend partitions on node mspl01 in group "rtrlkg" at Tue Oct 15 13:40:53 2002
```

```
Partition name: Partition_A
```

```
Configuration:-
```

```
Facility: SHADOW_TEST State: pri_act①
Low bound: "A" High bound: "A"
Active servers: 0 Free servers: 1②
Transaction presentation: active③ Last Rcvy BE: mswe01④
Active transaction count: 0⑤ Transactions recovered: 0
Failover policy: fail_to_standby Key range ID: 16777216
Master router: (nil)⑥ Relative priority: 2⑦
Recovery Retry Count: 0⑧ Resource Manager:
Features: Shadow, NoStandby, Concurrent⑨
```

SHOW PARTITION

```
Partition name: Partition_B
Configuration:-
Facility: SHADOW_TEST State: sec_act
Low bound: "B" High bound: "B"
Active servers: 0 Free servers: 1
Transaction presentation: active Last Rcvy BE: mswe01
Active transaction count: 0 Transactions recovered: 0
Failover policy: fail_to_standby Key range ID: 16777217
Master router: (nil) Relative priority: 2
Recovery Retry Count: 0 Resource Manager:
Features: Shadow, NoStandby, Concurrent
```

- ❶ Partition state, see Section 2.16.
- ❷ Number of servers available for processing.
- ❸ State of transaction processing.
- ❹ Node from which recovery information can be obtained.
- ❺ Number of transactions currently active.
- ❻ Nodename of master router, if any.
- ❼ Priority established with the SET PARTITION command.
- ❽ Number of retries for recovery in this partition.
- ❾ Features currently set for the given partition.

SHOW PROCESS

The **SHOW PROCESS** command displays information about processes that use RTR.

Format

SHOW PROCESS

Command Qualifiers	Defaults
/CLUSTER	/NOCLUSTER
/COUNTER[=counter-name]	/NOCOUNTER
/FULL	/NOFULL
/IDENTIFICATION=process-id	/NOIDENTIFICATION
/NODE[=node-list]	/NODE=default-node
/OUTPUT[=filespec]	/OUTPUT=stdout

Description

The SHOW PROCESS command displays information about the processes using RTR.

Qualifiers

/CLUSTER

/NOCLUSTER (D)

Specifies that the command is executed on all the nodes in the cluster.

If neither /NODE nor /CLUSTER is specified, the command is executed on the nodes specified by the latest SET ENVIRONMENT command. If no SET ENVIRONMENT command has been entered, the command is executed only on the node where the command was issued.

Note

In environments that do not support remote command capability, the /CLUSTER qualifier causes the relevant command to be executed on the local node only.

SHOW PROCESS

/COUNTER[=counter-name]

/NOCOUNTER (D)

Specifies that the process counters are also to be displayed. *counter-name* is the name of the counter to be displayed. If *counter-name* is omitted, all counters will be displayed. *counter-name* may contain wild card characters.

/IDENTIFICATION=process-id

/NOIDENTIFICATION (D)

Specifies the process about which information is required. The default (*/NOIDENTIFICATION*) displays all processes using RTR.

/FULL

/NOFULL (D)

Equivalent to specifying */COUNTER*.

/NODE[=node-list]

/NODE=default-node (D)

Specifies that the command is executed on all nodes specified in *node-list*. If *node-list* is omitted, the command is executed only on the node where the command was issued.

/OUTPUT[=filespec]

/OUTPUT=stdout (D)

Specifies that the resulting information is written to the file *filespec*. If */OUTPUT* or *filespec* is omitted, the standard or default output is used.

Examples

```
RTR> SHOW PROCESS
Processes:

Process-id   Process Name
326
```

SHOW REQUESTER

See **SHOW CLIENT**. The **SHOW REQUESTER** command has been replaced by **SHOW CLIENT** and is retained for compatibility reasons only.

SHOW RESOURCE_MANAGER (SHOW RM)

SHOW RESOURCE_MANAGER (SHOW RM)

The **SHOW RESOURCE_MANAGER** command displays resource manager (RM) instance information.

This command is available only on UNIX and Windows systems.

Format

```
SHOW RESOURCE_MANAGER [resource_name]
```

```
SHOW RM [resource_name]
```

Command Qualifiers

```
/CLUSTER
```

```
/FULL
```

```
/NODE[=node-list]
```

```
/OUTPUT[=filespec]
```

Defaults

```
/NOCLUSTER
```

```
/NOFULL
```

```
/NODE=default-node
```

```
/OUTPUT=stdout
```

Description

The **SHOW RESOURCE_MANAGER** command displays information for registered RMs. This command shows information for one or more RMs registered with the current TM.

Note

This command is available only on UNIX and Windows systems.

Refer to Appendix C, RTR XA Support for support information about XA.

Parameters

resource_name

Specifies the name of the resource manager instance you want to display. `resource_name` may contain wildcards (* and %), in which case all matching resources are displayed. If `resource_name` is omitted, all configured resources are displayed.

SHOW RESOURCE_MANAGER (SHOW RM)

Qualifiers

/CLUSTER

/NOCLUSTER (D)

Specifies that the command is executed on all the nodes in the cluster.

If neither `/NODE` nor `/CLUSTER` is specified, the command is executed on the nodes specified by the latest `SET ENVIRONMENT` command. If no `SET ENVIRONMENT` command has been entered, the command is executed only on the node where the command was issued.

Note

In environments that do not support remote command capability, the `/CLUSTER` qualifier causes the relevant command to be executed on the local node only.

/FULL

/NOFULL (D)

Displays additional information for facilities that reference a particular RM. If no `rmi_name` is included, displays information for all RMs.

/NODE[=node-list]

/NODE=default-node (D)

Specifies that the command is executed on all nodes specified in `node-list`. If `node-list` is omitted, the command is executed only on the node where the command was issued.

/OUTPUT[=filespec]

/OUTPUT=stdout (D)

Specifies that the resulting information is written to the file `filespec`. If `/OUTPUT` or `filespec` is omitted, the standard or default output is used.

Related commands

- REGISTER RESOURCE_MANAGER
- UNREGISTER RESOURCE_MANAGER

SHOW RESOURCE_MANAGER (SHOW RM)

Examples

```
RTR> SHOW RM rmi_0 /full
Resource Manager:
RMI Name          : rm_0
RMID              : 0
XA Switch         : msqlsrvxal
Library path      : .\xadll.dll
The facility associated with this RM: xatest
```

SHOW RTR

The **SHOW RTR** command displays the configuration and status of RTR.

Format

SHOW RTR

Command Qualifiers	Defaults
/CLUSTER	/NOCLUSTER
/COUNTER[=counter-name]	/NOCOUNTER
/FULL	/NOFULL
/NODE[=node-list]	/NODE=default-node
/OUTPUT[=filespec]	/OUTPUT=stdout
/STATUS	/NOSTATUS
/VERSION	/NOVERSION

Description

The SHOW RTR command displays the configuration and status of RTR.

Qualifiers

/CLUSTER

/NOCLUSTER (D)

Specifies that the command is executed on all the nodes in the cluster.

If neither /NODE nor /CLUSTER is specified, the command is executed on the nodes specified by the latest SET ENVIRONMENT command. If no SET ENVIRONMENT command has been entered, the command is executed only on the node where the command was issued.

Note

In environments that do not support remote command capability, the /CLUSTER qualifier causes the relevant command to be executed on the local node only.

/COUNTER[=counter-name]

/NOCOUNTER (D)

Specifies that the per-node counters are also to be displayed. Counter-name is the name of the counter to be displayed. If counter-name is omitted, all

SHOW RTR

counters will be displayed. Counter-name may contain wild card characters. Counter names should be all lowercase.

Recovery Protocol Version

The counter `crm_be_recovery_protocol` can take two values which refer to the version of the subsystem, not RTR as a whole. The values are described in Table 9–25.

Table 9–25 Recovery Version

Value	Meaning
3020 0000	V3.2 recovery
3021 0000	V4 recovery

/FULL

/NOFULL (D)

Equivalent to specifying `/COUNTER/STATUS`.

/NODE[=node-list]

/NODE=default-node (D)

Specifies that the command is executed on all nodes specified in `node-list`. If `node-list` is omitted, the command is executed only on the node where the command was issued.

/OUTPUT[=filespec]

/OUTPUT=stdout (D)

Specifies that the resulting information is written to the file `filespec`. If `/OUTPUT` or `filespec` is omitted, the standard or default output is used.

/STATUS (D)

/NOSTATUS

Displays the current status of RTR (started, stopped and so on).

/VERSION

/NOVERSION (D)

Displays the RTR version.

Related commands

- STOP RTR
- START RTR

Example

```
RTR> SHOW RTR ❶
```

```
RTR running on node baby.home.dec.com in group: develpr ❷
```

- ❶ Shows the state and configuration of RTR.
- ❷ Shows RTR has been started in group mode for group develpr.

SHOW SEGMENT

SHOW SEGMENT

The **SHOW SEGMENT** command displays the type and size of routing key segments.

Format

SHOW SEGMENT

Command Qualifiers	Defaults
/CLUSTER	/NOCLUSTER
/FACILITY[=facility-name]	/FACILITY=""
/FULL	/NOFULL
/NODE[=node-list]	/NODE=default-node
/OUTPUT[=filespec]	/OUTPUT=stdout

Description

The SHOW SEGMENT command displays the routing key segment definitions.

The routing key definition is common to all servers in a facility.

The routing key specifies the data within a message sent from clients used to route the message to a particular key range server.

The position, length and data type of each key segment is displayed.

Qualifiers

/CLUSTER

/NOCLUSTER (D)

Specifies that the command is executed on all the nodes in the cluster.

If neither /NODE nor /CLUSTER is specified, the command is executed on the nodes specified by the latest SET ENVIRONMENT command. If no SET ENVIRONMENT command has been entered, the command is executed only on the node where the command was issued.

Note

In environments that do not support remote command capability, the /CLUSTER qualifier causes the relevant command to be executed on the local node only.

/FACILITY**/FACILITY="*" (D)**

Specifies the facility name for which information should be displayed.

By default, information is displayed for all facilities.

/NODE[=node-list]**/NODE=default-node (D)**

Specifies that the command is executed on all nodes specified in `node-list`. If `node-list` is omitted, the command is executed only on the node where the command was issued.

/OUTPUT[=filespec]**/OUTPUT=stdout (D)**

Specifies that the resulting information is written to the file `filespec`. If `/OUTPUT` or `filespec` is omitted, the standard or default output is used.

Examples

```
RTR> SHOW SEGMENT ❶
```

Facility	Data Type	Length	Offset
RTR\$DEFAULT_FACILITY	UNSIGNED	1	0 ❷
TEST_FAC	SIGNED	4	10

- ❶ Shows the routing key segments for all facilities.
- ❷ Shows the facility name, the routing key data type, key length and offset for each facility.

SHOW SERVER

SHOW SERVER

The **SHOW SERVER** command displays information about server channels.

Format

SHOW SERVER

Command Qualifiers	Defaults
/CLUSTER	/NOCLUSTER
/FACILITY[=facility-name]	/FACILITY=""
/FULL	/NOFULL
/IDENTIFICATION=process-id	/NOIDENTIFICATION
/NODE[=node-list]	/NODE=default-node
/OUTPUT[=filespec]	/OUTPUT=stdout

Description

The SHOW SERVER command displays information about server channels.

Information such as PID, key range, state, event mask, event name and partition ID can be displayed.

The State: field of the SHOW SERVER command can display the following values:

Table 9–26 Key-Range States

State	Meaning
wt_tr_ok	Server is waiting for routers to accept it
wt_quorum	Server is waiting for backend to be quorate
lcl_rec	Local recovery
lcl_rec_fail	Primary server waiting for access to a restart journal
lcl_rec_icpl	Getting next journal to recover from
lcl_rec_cpl	Processed all journals for local recovery
shd_rec	Shadow recovery
shd_rec_fail	Shadow server waiting for access to a restart journal
shd_rec_icpl	Shadow getting next journal to recover from

(continued on next page)

Table 9–26 (Cont.) Key-Range States

State	Meaning
shd_rec_cpl	Processed all journals for shadow recovery
catchup	Secondary is catching up with primary
standby	Server is declared as standby
active	Server is active
pri_act	Server is active as primary shadow
sec_act	Server is active as secondary shadow
remember	Primary is running without shadow secondary

The `Flags:` field of the `SHOW SERVER` command can display the following values:

Table 9–27 Server Flags

FLAG	Meaning
BEC	Backend callout
EXA	Explicit accept
EXP	Explicit prepare
NCC	No concurrent
NSB	No standby
SHD	Shadow
SRV	Server
TRC	Router callout

Qualifiers

/CLUSTER

/NOCLUSTER (D)

Specifies that the command is executed on all the nodes in the cluster.

If neither `/NODE` nor `/CLUSTER` is specified, the command is executed on the nodes specified by the latest `SET ENVIRONMENT` command. If no `SET ENVIRONMENT` command has been entered, the command is executed only on the node where the command was issued.

SHOW SERVER

Note

In environments that do not support remote command capability, the /CLUSTER qualifier causes the relevant command to be executed on the local node only.

/IDENTIFICATION=process-id

/NOIDENTIFICATION (D)

Specifies the PID of the process for which information should be displayed. The default (/NOIDENTIFICATION) displays information for all servers.

/FACILITY

/FACILITY="*" (D)

Specifies the facility name for which information should be displayed.

By default, information is displayed for all facilities.

/FULL

/NOFULL (D)

Specifies a detailed listing of server information.

/NODE[=node-list]

/NODE=default-node (D)

Specifies that the command is executed on all nodes specified in node-list. If node-list is omitted, the command is executed only on the node where the command was issued.

/OUTPUT[=filespec]

/OUTPUT=stdout (D)

Specifies that the resulting information is written to the file filespec. If /OUTPUT or filespec is omitted, the standard or default output is used.

Examples

```
RTR> SHOW SERVER
Servers:
```

Process-id	Facility	Channel	Flags	State
20828	RTR\$DEFAULT_FACILITY	589825	SRV	active
20828	RTR\$DEFAULT_FACILITY	655362	SRV	active

```
RTR> SHOW SERVER/FULL
```

```
Servers on node NODEA in group "groupa" at Tue Jul 18 15:00:17 2000
```

```
Process-id:                27C3EEAE
```

SHOW SERVER

Configuration:-

Facility:	RTR\$DEFAULT_FACILITY	Flags:	SRV
Channel:	803667970	Low Bound:	0
State:	active	rcpnam:	"RTR\$DEFAULT_CHANNEL"
High Bound:	4294967295	RTR Events:	0
User Events:	0		
Partition name:			RTR\$DEFAULT_PARTITION_16777217

SHOW SERVICEPROVIDER

SHOW SERVICEPROVIDER

The **SHOW SERVICEPROVIDER** command displays information about serviceprovider instances.

Use of this command requires the RTR Java Toolkit.

Format

```
SHOW SERVICEPROVIDER [serviceprovider_name]
```

Command Qualifiers

```
/NODE[=node-list]  
/OUTPUT[=filespec]
```

Defaults

```
/NODE=default-node  
/OUTPUT=stdout
```

Description

The **SHOW SERVICEPROVIDER** command displays information about serviceprovider instances in the RTR ACP.

See the related commands and the RTR Glossary in the *HP Reliable Transaction Router Getting Started* for additional information on this and other Java-related commands.

Parameters

serviceprovider_name

Specifies the name of the serviceprovider to be displayed. If *serviceprovider_name* is omitted, all configured serviceproviders are displayed.

Qualifiers

/NODE[=node-list]

/NODE=default-node

Execute the command on all nodes specified in *node-list*. If *node-list* is omitted, the command is executed only on the node where the command was issued.

/OUTPUT[=filespec]

/OUTPUT=stdout

Writes the resulting information to the file *filespec*. If */OUTPUT* or *filespec* is omitted, then standard or default output is used.

Related Commands

- CREATE SERVICEPROVIDER
- SHOW CONNECTIONPOOL
- SHOW DATASOURCE

The following example shows the result of using the SHOW SERVICEPROVIDER command.

Examples

```
RTR> SHOW SERVICEPROVIDER ❶

ServiceProvider on node NodeA in group "JavaRTRSample" at Tue Oct 15 17:06:27
2002

ServiceProvider Name      : myservice ❷
INITIAL CONTEXT FACTORY  : com.sun.jndi.fscontext.RefFSContextFactory ❸
OBJECT_FACTORIES         :
URL_PKG_PREFIXES         :
PROVIDER_URL             :
DNS_URL                  :
```

- ❶ Shows information about all defined ServiceProviders.
- ❷ Name of the ServiceProvider.
- ❸ Reference to the initial context factory of the ServiceProvider.

SHOW TRANSACTION

SHOW TRANSACTION

The **SHOW TRANSACTION** command displays information about currently active transactions.

Format

SHOW TRANSACTION [transaction-id]

Command Qualifiers	Defaults
/BACKEND	/NOBACKEND
/BEFORE[=date]	today
/CLUSTER	/NOCLUSTER
/FACILITY[=facility-name]	/FACILITY=""
/FRONTEND	/NOFRONTEND
/FULL=keyword	/NOFULL
/IDENTIFICATION=process-id	/NOIDENTIFICATION
/NODE[=node-list]	/NODE=default-node
/OUTPUT[=filespec]	/OUTPUT=stdout
/PARTITION=partition_name	None
/ROUTER	/NOROUTER
/SINCE[=date]	today
/STATE=current_state	None
/USER=username	All users

Description

The **SHOW TRANSACTION** command displays transaction information, such as the transaction ID, facility, transaction state, frontend user, start time and router node.

Parameters

transaction-id

Specifies a particular transaction or transactions whose transaction state you want to display. If no `transaction_id` is specified, all transactions (*) that satisfy the specifying qualifiers are processed by the command.

Qualifiers

/BACKEND

/NOBACKEND (D)

Specifies that information should be listed for transactions in a backend node. If neither `/BACKEND`, `/FRONTEND` nor `/ROUTER` are specified,

information for all of them is displayed. If either `/FRONTEND` or `/ROUTER` is specified, the default (`/NOBACKEND`) inhibits display of backend transaction information.

The Invocation field of `SHOW TRANSACTION /BACKEND /FULL` shows the following information:

Table 9–28 Transaction Invocation Types

Type	Meaning
ORIGINAL	Original transaction
REPLAY	Replayed transaction
RECOVERY	Shadow recovery transaction
WaitOnExcept	Transaction is pending manual intervention

`/BEFORE[=date]`

Selects only those transactions whose timestamp is before the specified date. Default is the current date.

`/CLUSTER`

`/NOCLUSTER (D)`

Specifies that the command is executed on all the nodes in the cluster.

If neither `/NODE` nor `/CLUSTER` is specified, the command is executed on the nodes specified by the latest `SET ENVIRONMENT` command. If no `SET ENVIRONMENT` command has been entered, the command is executed only on the node where the command was issued.

Note

In environments that do not support remote command capability, the `/CLUSTER` qualifier causes the relevant command to be executed on the local node only.

`/FACILITY`

`/FACILITY="*" (D)`

Specifies the facility name for which information should be displayed.

By default, information is displayed for all facilities.

SHOW TRANSACTION

/FRONTEND

/NOFRONTEND (D)

Specifies that information should be listed for transactions in a frontend node. If neither **/BACKEND**, **/FRONTEND** nor **/ROUTER** are specified, information for all of them is displayed. If either **/BACKEND** or **/ROUTER** is specified, the default (**/NOFRONTEND**) inhibits display of frontend transaction information.

/FULL=keyword

/NOFULL (D)

Produces a detailed listing of transaction information. **keyword** can be either **STANDARD** or **WIDE**. **STANDARD** is the default value and provides the display seen in versions of RTR prior to Version 4.0. **WIDE** supports display field values of more than 36 character without truncation.

/IDENTIFICATION=process-id

/NOIDENTIFICATION (D)

Specifies the PID of the process for which information is displayed. The default (**/NOIDENTIFICATION**) displays information for all processes.

/NODE[=node-list]

/NODE=default-node (D)

Specifies that the command is executed on all nodes specified in **node-list**. If **node-list** is omitted, the command is executed only on the node where the command was issued.

/OUTPUT[=filespec]

/OUTPUT=stdout (D)

Specifies that the resulting information is written to the file **filespec**. If **/OUTPUT** or **filespec** is omitted, the standard or default output is used.

/PARTITION

/PARTITION=partition_name

Specifies that information should be listed for the indicated partition. A partition name must be supplied.

Use **SHOW PARTITION** to view the names of the currently active partitions.

/ROUTER

/NOROUTER (D)

Specifies that information should be listed for transactions in a router node. If neither **/BACKEND**, **/FRONTEND** nor **/ROUTER** are specified, then information for all of them is displayed. If either **/BACKEND** or **/FRONTEND** is specified, the default (**/NOROUTER**) inhibits display of router transaction information.

The Key-Range-State field for SHOW TRANSACTION /ROUTER /FULL shows the following states:

Table 9–29 Key-Range States

State	Meaning
locl_rec	Local recovery in progress
shad_rec	Shadow recovery in progress
active	Active non-shadowed
sec_act	Secondary active
pri_act	Primary active
pri_lone	Primary running alone
sec_chup	Secondary is catching up

/SINCE[=date]

Selects only those transactions whose timestamp is after the specified date. Default is the current date.

/STATE=current_state

Displays a particular transaction or a set of transactions that are in the specified current_state transaction state. This qualifier is required and the current_state value must be specified.

Value of current_state may be one of the following:

SENDING
VOTED
COMMIT
EXCEPTION
PRI_DONE

/USER[=user-id]

/USER=all users (D)

Allows you to display transactions that were initiated by a client process.

If /USER is not specified, transactions for all users are displayed.

SHOW TRANSACTION

Examples

```
RTR> SHOW TRANSACTION/BACKEND/FULL
Backend transactions on node NODEA in group "user" at Wed Nov 20 11:11:49 2002
```

```
Tid:                                e100b810,0,0,0,0,a85,83290001
Facility:                            DESIGN
Frontend:                             *tbs*
State:                                RECEIVING
Key-Range_id:                         16777219
Invocation:                           ORIGINAL
Recovering-Key-Ranges:                 0
Server-Pid:                            20828
Journal-Node:                          NODEA
First-Enq:                              1
Nr-Replies:                             0
FE-User:                               user.7780
Start-Time:Tue Nov 19 15:53:53 2002
Router:                                 bronze
Active-Key-Ranges:                     1
Total-Tx-Enqs:                         1
Server-State:                           RECEIVING
Journal-State:                           SENDING
Nr-Enqs:                                1
```

SHOW VERSION

The **SHOW VERSION** command displays the version of RTR running on the node where the command is issued.

Format

```
SHOW VERSION
```

Description

The **SHOW VERSION** command displays the version of RTR running on the node where the command is executed.

SPAWN

SPAWN

The **SPAWN** command allows you to execute operating system commands without leaving the RTR utility.

Note

This command is not available in the RTR web browser interface.

Format

SPAWN [operating-system-command]

Command Qualifiers

/INPUT=filespec
/OUTPUT=filespec
/WAIT

Defaults

/NOINPUT
/OUTPUT=stdout
/NOWAIT

Description

The SPAWN command allows you to execute operating system commands without leaving the RTR session. If you specify an operating system command as the parameter to SPAWN, the command is executed in the context of a spawned subprocess. For example, the command SPAWN mail invokes the mail utility; when you exit from mail, you return to your RTR session.

If you do not specify a parameter, the SPAWN command enters the operating system command level in the spawned subprocess. You can then enter commands; you can return to your RTR session by exiting the subprocess.

Parameters

operating-system-command

Can be any operating system command.

Qualifiers

/INPUT=filespec

/NOINPUT (D)

Specifies an input file containing one or more shell commands to be executed by the spawned subprocess. If you specify a command and an input file (with the /INPUT qualifier), the command string is processed before the input file. Once processing of the input file is complete, the subprocess is terminated.

/OUTPUT=filespec

/OUTPUT=stdout (D)

/NOOUTPUT

Requests that the output from the SPAWN operation is written to the filespec.

/WAIT (D)

/NOWAIT

Specifies that the “waited” form of the system service be used (default). Use the /NOWAIT qualifier if the unwaited form of the system service is required.

START HTTP_SERVER

START HTTP_SERVER

The **START HTTP_SERVER** starts the HTTP server on the computer system where you wish to use web-based management functions.

Format

START HTTP_SERVER

Command Qualifiers

/ACCESS=READ_ONLY

/[NO]USER_AUTHENTICATION

Defaults

Write, edit

/USER-AUTHENTICATION

Description

The **START HTTP_SERVER** command allows you to start the HTTP server on the target computer system. This command must be issued before you can access the web-based management functions. It must be issued for each user of the management features.

Qualifiers

/ACCESS=READ_ONLY

The servers can be started in read-only mode. If this qualifier is not specified, the default access is **WRITE, EDIT**.

/USER_AUTHENTICATION (D)

/NOUSER_AUTHENTICATION

By default, the servers require HTTP clients to provide a user name and password which will be validated by the host computer operating system. Use **/NOUSER_AUTHENTICATION** to disable this feature and allow anonymous access.

START RTR

The **START RTR** command starts the RTR Application Control Process (ACP) on one or more nodes. The RTR CLI (Command Line Interface) must be running to execute this command.

Format

START RTR

Qualifiers valid on all RTR systems:

Command Qualifiers	Defaults
/CLUSTER	/NOCLUSTER
/NODE[=node-list]	/NODE=default-node
/OUTPUT[=filespec]	/OUTPUT=stdout
/PARTITIONS[partition-quantity]	/PARTITIONS=500
/RESERVE_MEMORY_SIZE=m-size	/RESERVE_MEMORY_SIZE=10

Qualifiers valid only on OpenVMS systems.

Command Qualifiers	Defaults
/ASTLM=AST-limit	Depends on /LINKS and /PROCESSES values
/BIOLM=io-buffered	Depends on /LINKS and /PROCESSES values
/BYTLM=buffer-limit	/BYTLM=1000000
/CPULM=time-limit	/CPULM=default-time-limit
/DIOLM=io-direct	/Depends on /LINKS and /PROCESSES values
/ENQLM=enqueue-limit	/ENQLM=2000
/FILLM=file-limit	Depends on /LINKS and /PROCESSES values
/JTQUOTA=job-table-quota	/JTQUOTA=5000
/LINKS=max-links	/LINKS=512
/PGFLQUOTA=pages quota	Depends on several values
/PRCLM=subprocess-limit	/PRCLM=10
/PRIORITY=priority	/PRIORITY=6
/PROCESSES=max-processes	/PROCESSES=64
/TQELM=queue-limit	/TQELM=2000
/WSDEFAULT=working-set	/WSDEFAULT=2000
/WSEXTENT=extent	/WSEXTENT=20000 pages
/WSQUOTA=max-working-set	/WSQUOTA=10000 pages

START RTR

Description

The START RTR command starts the RTRACP on one or more nodes.

When RTR is started on a node, a detached process called the RTRACP is created. This process performs transaction and communication activities for *all users of RTR* running on that node in the same group.

The START RTR command must be issued before adding RTR facilities or starting application programs that use RTR.

When running on OpenVMS systems, the quota qualifiers affect the way the RTRACP is created. The default values will suffice for many applications. The values for quota qualifiers take effect independently of SYSGEN settings. This means that RTR can be started with different quotas without rebooting the system. The quota qualifiers are similar to those specified with the DCL RUN /DETACHED command.

If you use obsolete RTR Version 2 qualifiers with the START RTR command, a warning is issued. Qualifiers affected are `partitions`, `cache_pages`, and `relations`. Warnings are also generated if an OpenVMS qualifier is used on a non-OpenVMS platform.

Qualifiers

/ASTLM=AST-limit

/ASTLM=(max-links + max-processes) × 2 + 10 = default AST-limit (D)

This qualifier is relevant only on OpenVMS systems.

Specifies the AST limit for the RTRACP.

The value for AST-limit must include five for RTRACP mailbox reads and timer scheduling and a minimum of two per DECnet logical link maintained by RTR.

For example, in a 20-node configuration, a router node needs an ASTLM of at least 45 (10 + (20 × 2)).

In systems where a lot of traffic is expected, defining additional ASTLM quota will enable lookahead I/O to be booked to channels without RTRACP being held up in a resource wait.

The default value of AST-limit is automatically calculated, based on the value of /LINKS and /PROCESSES.

/BIOLM=io-buffered

/BIOLM=(max-links + max-processes) × 2 + 10 = default io-buffered (D)

This qualifier is relevant only on OpenVMS systems.

Specifies the maximum number of system-buffered I/O operations that the RTRACP can have outstanding at any one time.

The default value of `io-buffered` is automatically calculated, based on `/LINKS` and `/PROCESSES` values.

`/BYTLM=buffer-limit`

`/BYTLM=1000000 (D)`

This qualifier is relevant only on OpenVMS systems.

Specifies the maximum amount of memory, in bytes, that the RTRACP can use for buffered I/O operations or temporary mailbox creation.

This should be sufficiently large to account for lookahead DECnet traffic.

The default for `buffer-limit` is 1000000 bytes.

`/CLUSTER`

`/NOCLUSTER (D)`

Specifies that the command is executed on all the nodes in the cluster.

If neither `/NODE` nor `/CLUSTER` is specified, the command is executed on the nodes specified by the latest `SET ENVIRONMENT` command. If no `SET ENVIRONMENT` command has been entered, the command is executed only on the node where the command was issued.

Note

In environments that do not support remote command capability, the `/CLUSTER` qualifier causes the relevant command to be executed on the local node only.

`/CPULM=time-limit`

`/CPULM=default-time-limit (D)`

This qualifier is relevant only on OpenVMS systems.

Specifies the maximum amount of CPU time (in delta time) allocated to the RTRACP. The unit of `time-limit` is 10 milliseconds. When the time expires, the RTRACP is deleted.

The default value is established at system-generation time.

A `time-limit` value of 0 indicates that CPU time is not restricted.

START RTR

/DIOLM=io-direct

/DIOLM=(max-links + max-processes) × 2 + 10 = default io-direct (D)

This qualifier is relevant only on OpenVMS systems.

Specifies the maximum number of direct I/O operations that the RTRACP can have outstanding at any one time.

If you do not specify a direct I/O quota, the default value established at system generation time is used.

The default for io-direct is automatically calculated based on the values for /LINKS and /PROCESSES.

/ENQLM=enqueue-limit

/ENQLM=2000 (D)

This qualifier is relevant only on OpenVMS systems.

Specifies the maximum number of locks that the RTRACP can have outstanding at any one time.

The default for enqueue-limit is 2000.

/FILLM=file-limit

/FILLM=(max-links + max-processes) + 10 = default file-limit (D)

This qualifier is relevant only on OpenVMS systems.

Specifies the maximum number of files that the RTRACP can have open at any one time.

The default value of file-limit is automatically calculated, based on the values of /LINKS and /PROCESSES.

/JTQUOTA=job-table-quota

/JTQUOTA=5000 (D)

This qualifier is relevant only on OpenVMS systems.

Allows you to specify a quota for the job-wide logical name table for the RTRACP.

The default for job-table-quota is 1024.

/LINKS=max-links

/LINKS=512 (D)

This qualifier is relevant only on OpenVMS systems.

Specifies the maximum number of nodes with which this node can communicate. The default for max-links is 512.

/NODE[=node-list]

/NODE=default-node (D)

Specifies that the command is executed on all nodes specified in node-list. If node-list is omitted, the command is executed only on the node where the command was issued.

/OUTPUT[=filespec]

/OUTPUT=stdout (D)

Specifies that the resulting information is written to the file filespec. If /OUTPUT or filespec is omitted, the standard or default output is used.

/PARTITIONS=partition-quantity

/PARTITIONS=500 (D)

Specifies the maximum number of partitions allowed. The maximum allowable number is 65536. Partition quantity is dynamically allocated to the current maximum, which helps to minimize the use of memory for the user who needs very few partitions. If the /PARTITIONS qualifier is not used, the default (500) is used.

/PGFLQUOTA=pages

/PGFLQUOTA=((max-links + max-processes) × 400) + 35000 + (reserve_memory_size × 2048) + ((CHANNEL_WAITQ_CAPACITY × max-processes × 5) / 512) = default pages (D)

where CHANNEL_WAITQ_CAPACITY is the larger of:

(MAX_CHANNEL_WAITQ_BYTES × EVENT_CHANNEL_LIMIT_PC) / 100

or

(MAX_CHANNEL_WAITQ_BYTES × 2)

If not defined, MAX_CHANNEL_WAITQ_BYTES and EVENT_CHANNEL_LIMIT_PC take their respective defaults. For their defaults, see Table 2–3, RTR Environment Variables.

This qualifier is relevant only on OpenVMS systems.

Specifies the maximum number of pages allocated in the paging file for the RTRACP. The paging file quota is the amount of secondary storage available during execution of the RTRACP image and limits available virtual memory. Note that a shortage of virtual memory can cause transactions to fail.

The default value of pages is automatically calculated, based on the values of /LINKS, /PROCESSES and /RESERVE_MEMORY_SIZE.

START RTR

/PRCLM=subprocess-limit

/PRCLM=10 (D)

This qualifier is relevant only on OpenVMS systems.

Specifies the maximum number of subprocesses that the RTRACP can create.

The default for subprocess-limit is 10.

/PRIORITY=priority

/PRIORITY=6 (D)

This qualifier is relevant only on OpenVMS systems.

Requires alter priority (ALTPRI) privilege to set the priority higher than your current process.

Specifies the base priority at which the RTRACP executes.

The priority value is a decimal number from 0 through 31, where 31 is the highest priority and 0 is the lowest. Normal priorities range from 0 through 15; real-time priorities range from 16 through 31.

Higher priorities result in faster response, but lower priorities may be more CPU efficient and give a higher overall throughput.

/PROCESSES=max-processes

/PROCESSES=64 (D)

This qualifier is relevant only on OpenVMS systems.

Specifies the maximum number of processes that can use RTR on this node.

The default is 64.

/RESERVE_MEMORY_SIZE=memory-size

/RESERVE_MEMORY_SIZE=10 (D)

Specifies the amount of heap memory, in megabytes, reserved by the RTRACP at startup. This reserve memory is used when the RTRACP is critically low on heap memory, and serves as a buffer to keep the RTRACP from exiting immediately. A log entry, ACPLOWMEMORY, is written when the RTRACP is forced to use the reserve memory. Another log entry, ACPSUFMEMORY, is written after the RTRACP no longer needs to use the reserve memory.

When the reserve memory is in use, all new and uncommitted transactions are subject to automatic rejection.

The minimum value is 1MB, the maximum value is 500 MB, and the default value is 10MB.

/TQELM=queue-limit**/TQELM=2000 (D)**

This qualifier is relevant only on OpenVMS systems.

Specifies the maximum number of timer queue entries that the RTRACP can have outstanding at any one time. This number includes timer requests and scheduled wakeup requests.

The default for `queue-limit` is 2000.

/WSDEFAULT=working-set**/WSDEFAULT=2000 (D)**

This qualifier is relevant only on OpenVMS systems.

Specifies the default working set size for the image running in the RTRACP.

`working-set` cannot be greater than the working set quota (specified with the `/WSQUOTA` qualifier).

The default for `working-set` is 2000.

/WSEXTENT=extent**/WSEXTENT=20000 pages (D)**

This qualifier is relevant only on OpenVMS systems.

Specifies the maximum size in pages to which the image running in the RTRACP can increase its physical memory size.

The default for `extent` is 20000 pages.

/WSQUOTA=max-working-set**/WSQUOTA=10000 pages (D)**

This qualifier is relevant only on OpenVMS systems.

Specifies the maximum size in pages to which the image being executed in the RTRACP process can increase its working set size.

The default for `max-working-set` is 10000 pages.

Related commands

- SHOW RTR
- STOP RTR

START RTR

Examples

See Chapter 2, *Starting and Setting Up RTR*, for examples of how to use the START RTR command.

STOP HTTP_SERVER

The **STOP HTTP_SERVER** stops the HTTP server.

Format

```
STOP HTTP_SERVER
```

Description

The **STOP HTTP_SERVER** command stops the HTTP server. This command must be issued for each user of the web-based management features.

STOP RTR

STOP RTR

The **STOP RTR** command stops RTR on one or more nodes.

Format

STOP RTR

Command Qualifiers

/ABORT

/CLUSTER

/NODE[=node-list]

/OUTPUT[=filespec]

Defaults

/NOABORT

/NOCLUSTER

/NODE=default-node

/OUTPUT=stdout

Description

The STOP RTR command stops RTR in an orderly manner.

Alternatively, RTR can be stopped in an abrupt manner (/ABORT), and any applications using RTR are forced to exit.

Qualifiers

/ABORT

Specifying /ABORT causes RTR to stop, regardless of the state of any RTR user applications. Applications using RTR are forced to exit.

Note

This qualifier supersedes the /NOCONFIRM of earlier versions of RTR.

/CLUSTER

/NOCLUSTER (D)

Specifies that the command is executed on all the nodes in the cluster.

If neither /NODE nor /CLUSTER is specified, the command is executed on the nodes specified by the latest SET ENVIRONMENT command. If no SET ENVIRONMENT command has been entered, the command is executed only on the node where the command was issued.

Note

In environments that do not support remote command capability, the /CLUSTER qualifier causes the relevant command to be executed on the local node only.

/NODE[=node-list]

/NODE=default-node (D)

Specifies that the command is executed on all nodes specified in node-list. If node-list is omitted, the command is executed only on the node where the command was issued.

/OUTPUT[=filespec]

/OUTPUT=stdout (D)

Specifies that the resulting information is written to the file filespec. If /OUTPUT or filespec is omitted, the standard or default output is used.

Related commands

- SHOW RTR
- START RTR

Examples

See Chapter 2, Starting and Setting Up RTR, for examples of how to use the STOP RTR command.

TRIM FACILITY

TRIM FACILITY

The **TRIM FACILITY** command removes nodes or roles (or both) from an existing facility definition.

Format

```
TRIM FACILITY [facility_name]
```

Command Qualifiers

```
/BACKEND=backend-list  
/CLUSTER  
/FRONTEND=frontend-list  
/NODE[=node-list]  
/OUTPUT[=filespec]  
/ROUTER=router-list
```

Defaults

```
/NOBACKEND  
/NOCLUSTER  
/NOFRONTEND  
/NODE=default-node  
/OUTPUT=stdout  
/NOROUTER
```

Description

The **TRIM FACILITY** command removes nodes or roles (or both) from an RTR facility definition. A node can be removed from a facility or a role can be removed from a node. For example, a node having both router and frontend roles can be trimmed to have only a router role. When a role is trimmed from a facility definition, quorum is recalculated. This may cause a backend to lose quorum briefly.

A **TRIM FACILITY** command causing the removal of all roles is equivalent to a **DELETE FACILITY** command.

A frontend role can be removed from a node with the router role as long as there is at least one other frontend defined.

A backend role can be removed from a node with the router role as long as at least one other backend is defined. A command to remove a backend role should be executed on all router nodes to avoid problems with inconsistent facility definitions.

If a router role is removed, the node from which it is removed will discard its knowledge of other backends and frontends in the facility. If the router role is again added to the node (using **EXTEND FACILITY**), this information must be specified again.

To have a consistent facility definition across the nodes of the facility (avoiding problems with attaining quorum), the command to remove a router role must be executed on all relevant nodes. This means executing the command on the node losing the router role, plus all backend and frontend nodes which know about this router.

As with `CREATE` or `MODIFY FACILITY`, superfluous nodes or roles can be specified. That is, you can specify backend nodes on a node which only has a frontend role, and frontend nodes can be specified on a node which only has a backend role. This permits a single `RTR` management command to be issued on many nodes, and each node only accepts those parts of the command which are relevant to it.

When using this command, the facility being extended may lose quorum until the affected nodes agree upon the new facility definition. During this time, server applications will not be presented with any new transactions.

`RTR MONITOR QUORUM` displays a monitor picture which allows the quorum negotiations to be observed. You can use this after using a `TRIM FACILITY` command; once quorum has again been attained, the participating nodes return to the quorate state.

For example, in a three-node facility called `facnam`, the nodes `FE` and `NFE` have only frontend roles, and node `FETRBE` has frontend, router and backend roles. This facility could have been created as follows:

```
% RTR
RTR> SET ENVIRONMENT /NODE=(FE,FETRBE,NFE)
RTR> CREATE FACILITY facnam /FRONTEND=(NFE,FE,FETRBE) -
    /ROUTER=FETRBE -
    /BACKEND=FETRBE
```

The frontend node `NFE` can be removed from the facility as follows:

```
% RTR
RTR> SET ENVIRONMENT /NODE=(FETRBE,NFE)
RTR> TRIM FACILITY facnam /FRONTEND=NFE
```

Parameters

facility_name

Specifies the name of the facility to be trimmed.

The default value for `facility_name` is `RTR$DEFAULT_FACILITY`.

TRIM FACILITY

Qualifiers

/BACKEND=backend-list
/NOBACKEND (D)

Specifies the names of the nodes where backend roles for this facility are removed.

backend-list is a list of backend-nodes separated by commas. If there is more than one backend-node, backend-list must be enclosed in parentheses.

backend-node is either the name of a node or @filespec, where filespec specifies a text file containing a backend-list on each line.

/CLUSTER
/NOCLUSTER (D)

Specifies that the command is executed on all the nodes in the cluster.

If neither /NODE nor /CLUSTER is specified, the command is executed on the nodes specified by the latest SET ENVIRONMENT command. If no SET ENVIRONMENT command has been entered, the command is executed only on the node where the command was issued.

Note

In environments that do not support remote command capability, the /CLUSTER qualifier causes the relevant command to be executed on the local node only.

/FRONTEND=frontend-list
/NOFRONTEND (D)

Specifies the names of nodes where the frontend role is removed for this facility. frontend-list is a list of frontend-nodes separated by commas. If there is more than one frontend-node, frontend-list must be enclosed in parentheses.

frontend-node is either the name of a node or @filespec, where filespec specifies a text file containing a frontend-list on each line.

/NODE[=node-list]
/NODE=default-node (D)

Specifies that the command is executed on all nodes specified in node-list. If node-list is omitted, the command is executed only on the node where the command was issued.

/OUTPUT[=filespec]

/OUTPUT=stdout (D)

Specifies that the resulting information is written to the file filespec. If /OUTPUT or filespec is omitted, the standard or default output is used.

/ROUTER=router-list

/NOROUTER (D)

Specifies the names of the nodes where the router role is removed for this facility.

router-list is a list of router-nodes separated by commas. If there is more than one router-node, router-list must be enclosed in parentheses.

router-node is either the name of a node or @filespec, where filespec specifies a text file containing a router-list on each line.

Related commands

- SHOW FACILITY
- DELETE FACILITY
- CREATE FACILITY
- EXTEND FACILITY

UNREGISTER RESOURCE_MANAGER (UNREGISTER RM)

UNREGISTER RESOURCE_MANAGER (UNREGISTER RM)

The **UNREGISTER RESOURCE_MANAGER** command unregisters an instance of a resource manager.

Format

```
UNREGISTER RESOURCE_MANAGER [resource_name]
```

```
UNREGISTER RM [resource_name]
```

Command Qualifiers

/CLUSTER

/NODE[=node-list]

/OUTPUT[=filespec]

Defaults

/NOCLUSTER

/NODE=default-node

/OUTPUT=stdout

Description

The **UNREGISTER RESOURCE_MANAGER** command unregisters an instance of a resource manager. The command succeeds only when its facility no longer exists. To unregister a resource manager instance, you must first delete all facilities that reference it. To see what facilities reference a specific resource manager, use the command **SHOW RM/FULL**. Refer to Appendix C, RTR XA Support for support information about XA.

Parameters

resource_name

Specifies the name of the resource to be unregistered.

Resource names can contain up to 32 characters. This argument is required.

Qualifiers

/CLUSTER

/NOCLUSTER (D)

Specifies that the command is executed on all the nodes in the cluster.

If neither **/NODE** nor **/CLUSTER** is specified, the command is executed on the nodes specified by the latest **SET ENVIRONMENT** command. If no **SET ENVIRONMENT** command has been entered, the command is executed only on the node where the command was issued.

UNREGISTER RESOURCE_MANAGER (UNREGISTER RM)

Note

In environments that do not support remote command capability, the /CLUSTER qualifier causes the relevant command to be executed on the local node only.

/NODE[=node-list]

/NODE=default-node (D)

Specifies that the command is executed on all nodes specified in node-list. If node-list is omitted, the command is executed only on the node where the command was issued.

/OUTPUT[=filespec]

/OUTPUT=stdout (D)

Specifies that the resulting information is written to the file filespec. If /OUTPUT or filespec is omitted, the standard or default output is used.

Related commands

- REGISTER RESOURCE_MANAGER
- SHOW RESOURCE_MANAGER

Examples

```
UNREGISTER RM rmi_1
```

Creating Customized RTR Monitor Pictures

The standard monitor pictures provided with RTR (described in Chapter 8) are sufficient for most needs. You can also create your own monitor pictures to suit particular needs. This appendix tells you how to do this.

User-Modified Monitor Pictures

To ensure that your modified or new Monitor pictures are not overwritten when RTR upgrades are installed, always make your Monitor filenames unique. Do not reuse RTR Monitor picture names or copy Monitor files without renaming them.

The RTR monitor utility provides a means to continuously display the status of RTR and the applications using it. The information displayed is composed of named data items which are continuously updated by RTR. The data items can be displayed in various formats and combined using simple arithmetic operators and constants.

Note that in earlier versions of RTR, the data items were known as counters, and only contained numeric information. The name has been changed to indicate that string data can also be retrieved.

All RTR data items are associated with an information class. When entering a data item in a display command, prefix it with a string to indicate which class it belongs to. Information classes are shown in Table A-1.

Creating Customized RTR Monitor Pictures

Table A–1 Information Classes

Information Class	String
Per node	rtr
Per facility	fac
Per link to a node	lnk
Per client process	cli
Per server process	srv
Per application process	prc
Per partition on a router	rpt
Per partition on a backend	bpt
Per key segment	ksg
Per transaction on a frontend	ftx
Per transaction on a router	rtx
Per transaction on a backend	btx

The monitor is invoked using the RTR MONITOR command. RTR monitor displays a monitor screen that is periodically updated. See Section 9.2 for the full syntax of the MONITOR command.

A monitor screen contains elements that are either text (such as labels and titles) or variables derived from data items. Monitor screens can be defined either interactively at the RTR> prompt, or defined in a file called a monitor file.

The commands used to define and display monitor pictures are:

```
CLEAR  
DISPLAY BAR  
DISPLAY NUMERIC  
DISPLAY STRING  
DISPLAY SYMBOLIC  
DISPLAY TEXT  
MONITOR  
REMEMBER EXPRESSION  
SCROLL  
SHOW DISPLAY
```

These commands are described in the following sections.

A.1 Interactive Definition of a Monitor Picture

You can define your own monitor pictures using the CLEAR, DISPLAY, MONITOR, SCROLL, and SHOW DISPLAY commands, including information from RTR data structures. You can obtain information from RTR data structures by using RTR field names. The RTR *C Application Programmer's Reference Manual* lists field names for RTR data structures in its description of the `rtr_request_info` call().

Example A-1 shows a monitor picture being defined in an interactive RTR session.

Example A-1 Interactive Monitor Picture Definition

```
$ RTR
RTR> CLEAR /ALL ❶
RTR> DISPLAY TEXT /X=25 /Y=1 "THE TEST PICTURE AT $TIME" ❷
RTR> DISPLAY NUMERIC some-RTR-data-field - ❸
_RTR> /X=1 /Y=3 /LABEL ="SOME DATA ITEM: "
RTR> DISPLAY NUMERIC another-RTR-data-field - ❹
_RTR> /X=1 /Y=4 /LABEL ="OTHER DATA ITEM: "
RTR> MONITOR ❺
RTR> CLEAR /X=25 /Y=1 ❻
RTR> DISPLAY TEXT /X=25 /Y=1 "THE NEW PICTURE AT $TIME" ❼
RTR> SHOW DISPLAY /OUTPUT=MYPICTURE.MON ❽
```

- ❶ Any items from previously displayed pictures are cleared.
- ❷ A title is displayed on the first line. The symbol `$TIME` is substituted by the current system time when the picture is displayed. (See Section A.2, Substitution Symbols).
- ❸ The data item called `some-RTR-data-field` is displayed on the third line.
- ❹ The data item called `another-RTR-data-field` is displayed on the next line. Note that if `/X` and `/Y` are omitted, the item is displayed on the next free line and in the same column as the previous item.
- ❺ The monitor picture is displayed on the screen. Example A-2 shows what would appear on the screen at this point.
- ❻ The title is removed from the picture definition.
- ❼ A new title is added. This technique can also be used to make small alterations to standard monitor pictures.

Creating Customized RTR Monitor Pictures

A.1 Interactive Definition of a Monitor Picture

Example A-2 Interactively Defined Monitor Picture

THE TEST PICTURE AT 11:49:24

SOME DATA ITEM: 0
OTHER DATA ITEM: 0

- ⑧ The definition of the picture is saved in the text file *MYPICTURE.MON*. The saved picture can be redisplayed by entering MONITOR MYPICTURE:

Caution

Because monitor file definitions depend on the internal structure and data items of RTR, they may need to be changed for future versions of RTR.

Example A-3 Interactive Use of Remember Expression

```
$ RTR
RTR> CLEAR /ALL ①
%RTR-S-DISITMCLR, 5 monitor item(s) cleared
RTR> DISPLAY TEXT /X=25 /Y=1 "THE TEST PICTURE" ②
RTR> REMEMBER EXPRESSION TRIAL -
_RTR> /WARNING="tr_ptn_activations =0" -
_RTR> /MGWARN="No router partition activation" - ③
_RTR> /ERROR=0 /mgerror=unused -
_RTR> /FATAL=0 /mgfatal=unused
RTR> DISPLAY TEXT "No router partition activation"
/SELECT="$TRIAL_WARNING" ④
```

- ① Clears all items, including remembered expressions, from previous displays.
- ② Displays title.
- ③ Text used in REMEMBER EXPRESSION.
- ④ Displays result of evaluation of REMEMBER EXPRESSION. Example A-4 shows the result.

Creating Customized RTR Monitor Pictures

A.2 Substitution Symbols

Example A-4 Interactive Use of Remember Expression

```
THE TEST PICTURE
No router partition activation.
```

A.2 Substitution Symbols

The text and labels in the DISPLAY commands that are used to define monitor pictures can contain symbols which are substituted when the picture is displayed. Table A-2 contains a list of these symbols.

Table A-2 Substitution Symbols

Symbol	Description
\$TIME	Current time
\$DATE	Current date
\$NODE_NAME	Name of node where values were measured
\$LINK_NAME	Name of link for which values were measured
\$FACILITY_NAME	Name of facility for which value was measured
\$PROCESS_ID	ID of process for which value was measured
\$PROCESS_NAME	Name of process for which value was measured
\$IMAGE_NAME	Image file name of process for which value was measured
\$FULL_IMAGE_NAME	The full file specification of the image for the process for which values were measured

The field width for these predefined symbols can be specified by appending a colon (:) and then the required width. For example, \$TIME displays the current system time in the form 10:34:03, \$TIME:5 displays the first five characters of the system time, in this case, 10:34. If the field width specified is larger than the field, the data is left justified and space filled to the required width.

Creating Customized RTR Monitor Pictures

A.3 Arithmetic Expressions and Operators

A.3 Arithmetic Expressions and Operators

When using data items and constants as parameters for display commands, or as Booleans in the BELL, BLANK, BLINK, BOLD, SELECT, REVERSE and UNDERLINE qualifiers, you may use the operators shown in Table A-3.

Table A-3 Arithmetic Operators in Display Commands

Characters	Meaning
-	Minus
+	Plus
*	Multiply
/	Divide
&	Logical AND
	Logical OR
<=	Less than or equal
>=	Greater than or equal
!=	Not equal
<>	Not equal
<	Less than
>	Greater than
=	Equal

Example A-5 shows how these operators are used.

Creating Customized RTR Monitor Pictures

A.3 Arithmetic Expressions and Operators

Example A-5 Arithmetic Operators Examples

```
RTR> DISPLAY NUMERIC some-RTR-data-field+2      ❶
RTR> MONITOR

RTR> DISPLAY NUMERIC some-RTR-data-field
_RTR> /SELECT="another-RTR-data-field>42"      ❷
_RTR> MONITOR

RTR> DISPLAY NUMERIC some-RTR-data-field
_RTR> /SELECT="another-RTR-data-field>42" -
_RTR> /BOLD="another-RTR-data-field>84" -
_RTR> /UNDERLINE="another-RTR-data-field>=1952"  ❸
RTR> MONITOR

RTR> DISPLAY SYMBOLIC some-RTR-data-field "zero","one" -
_RTR> "two","three","four","five","six"/BLINK    ❹
```

- ❶ Two is added to the value of *some-RTR-data-field* before displaying it.
- ❷ *some-RTR-data-field* is displayed only if *another-RTR-data-field* is greater than 42.
- ❸ Same as the one above, but displayed in bold if *another-RTR-data-field* is greater than 84, and underlined if it is greater than 1952.
- ❹ The value of *some-RTR-data-field* is displayed in text form if it is less than six, otherwise it is displayed as a numeric.

Note

To ensure that a data string is correctly parsed, use double quotes and parentheses that follow algebraic rules.

Aggregation of Data Items

DISPLAY commands which select multiple instances of a data item (for example, multiple instances of a process counter) can use the following keywords to control the way the items are aggregated.

MIN Select the data item instance with the lowest value
MAX Select the data item instance with the highest value

By default, data items are totaled unless the /AVERAGE=() qualifier is specified.

Creating Customized RTR Monitor Pictures

A.3 Arithmetic Expressions and Operators

The following example from SYSTEM.MON, in which some output has been omitted for clarity, shows the use of the `_MIN` keyword:

```
! Warn if any messages have been pending for more than 30 seconds
DISPLAY TEXT    /X=32    /Y=17 -
  "X" -
  /BOLD -
  /SELECT="..."
  ((rtr:rtr_current_time - _MIN(prc:rtr_mt_received_time)) <= 30)"
DISPLAY TEXT    /X=40    /Y=17 -
  "X" -
  /BOLD /BLINK -
  /SELECT="..."
  ((rtr:rtr_current_time - _MIN(prc:rtr_mt_received_time)) > 30)"
```

A.4 Monitoring Memory Usage

You can use certain counters in user-defined Monitor pictures to monitor memory usage attributable to channel queues in the ACP. These wait queue (waitq) counters are described in Table A–4 for nodes, in Table A–5 for facilities, and in Table A–6 for processes.

The node counters in Table A–4 enable monitoring of the memory usage attributable to channel queues in the ACP.

Table A–4 RTR Wait Queue Node Counters

Node Waitq Counter Name	Description
env_ga_api_waitq_bytes_srv	Gauge (number) of bytes in API server wait queues (api_waitq_bytes_srv).
env_cn_api_waitq_bytes_srv_max	Maximum value (high water mark) of API server wait queues.
env_cn_api_waitq_bytes_srv_ts	Timestamp of high water mark of API server wait queues.
env_ga_api_waitq_bytes_cli	Gauge (number) of bytes in API client wait queue bytes (api_waitq_bytes_cli).
env_cn_api_waitq_bytes_cli_max	Maximum value (high water mark) of API client wait queue bytes.
env_cn_api_waitq_bytes_cli_ts	Timestamp of high water mark of API client wait queues.

The facility counters in Table A–5 enable monitoring of the memory usage attributable to channel queues in the ACP.

Table A–5 RTR Wait Queue Facility Counters

Facility Waitq Counter Name	Description
fdb_ga_api_waitq_bytes_srv	Gauge (number) of bytes in API server wait queues.
fdb_cn_api_waitq_bytes_srv_max	Maximum (high water mark) of API server wait queues.
fdb_cn_api_waitq_bytes_srv_ts	Timestamp of high water mark of API server wait queues.
fdb_ga_api_waitq_bytes_cli	Gauge (number) of bytes in API client wait queues.

(continued on next page)

Creating Customized RTR Monitor Pictures

A.4 Monitoring Memory Usage

Table A–5 (Cont.) RTR Wait Queue Facility Counters

Facility Waitq Counter Name	Description
<code>fdb_cn_api_waitq_bytes_cli_max</code>	Maximum (high water mark) of API client wait queues.
<code>fdb_cn_api_waitq_bytes_cli_ts</code>	Timestamp of high water mark of API client wait queues.

The process counters in Table A–6 enable monitoring of the memory usage attributable to channel queues in the ACP.

Table A–6 RTR Wait Queue Process Counters

Process Waitq Counter Name	Description
<code>rsc_ga_api_waitq_bytes_srv</code>	Gauge (number) of bytes in API server channel wait queues.
<code>rsc_cn_api_waitq_bytes_srv_max</code>	Maximum (high water mark) of server channel wait queues.
<code>rsc_cn_api_waitq_bytes_srv_ts</code>	Timestamp of high water mark of API server channel wait queues.
<code>rsc_ga_api_waitq_bytes_cli</code>	Gauge (number) of bytes in API client channel wait queues.
<code>rsc_cn_api_waitq_bytes_cli_max</code>	Maximum (high water mark) of client channel wait queues.
<code>rsc_cn_api_waitq_bytes_cli_ts</code>	Timestamp of high water mark of API client channel wait queues.

B

Customizing the RTR Web Browser Interface

This appendix explains how to customize the appearance of HTML pages generated by RTR. It also explains server security, including how client and user verification are performed.

In order for authentication to work on the RTR Manager when LDAP authentication is used on Linux, the 'userPassword' field on the LDAP server must allow 'read' permission. In some cases, the LDAP server may be configured to disallow read access on the 'userPassword' field for security. However, RTR is not LDAP aware, and thus will not be able to authenticate if the 'userPassword' field does not have read access.

The RTR Manager interface requires that the security setting for Microsoft Internet Explorer be set to Medium-Low for the RTR management interface to work. To change the security setting for Internet Explorer, click on Tools then Internet Options then Security Tab then either Custom or Default Level and select Medium-Low for the setting.

B.1 Style Customization

To supersede the built-in style sheet, you must have access to a file named `rtrhead.html`. This file can be accessed in one of the following operating-system dependent directories:

Server Operating System	File Location
HP-UX	<code>/opt/rtr/wbi</code>
OpenVMS	<code>RTR\$DIRECTORY</code>
Linux	<code>/var/opt/rtr</code>
Windows	RTR installation directory

The visual appearance of the RTR HTML displays may be customized to meet local needs and preferences by using the Cascading Style Sheet (CSS) language

Customizing the RTR Web Browser Interface

B.1 Style Customization

to provide an alternate definition of the styles used by RTR. This allows for considerable flexibility, permitting a choice of a wide range of formatting options, for example, fonts, colors, text properties and alignment, background color, image, and texture. Style sheets can be created as text files in the CSS language by any web-content editor, for example, MS Visual InterDev. Refer to the home page of the World Wide Web Consortium (<http://www.w3c.org/>) for details on the CSS language.

To supersede the built-in embedded style sheet, modify the file `rtrhead.html`. This file should contain an embedded style sheet defining how to render for the styles used by RTR (embedded style sheets should be bounded with a style tag).

B.1.1 RTR Style Names

The following table lists the style names referenced by RTR and their usage.

Table B-1 RTR Style Names

Style Name	Usage
<code>div.RtrMoniText</code>	Text frames appearing in monitor pictures
<code>p.RtrMoniText</code>	Controls paragraphs appearing within text frames in monitor pictures
<code>tr.RtrRowOdd</code>	Odd rows of tabular output
<code>tr.RtrRowEven</code>	Even rows of tabular output
<code>td.RtrCellReverse</code>	Emulates reverse video effect for monitor picture
<code>td.RtrCellBold</code>	Emulates bold video effect for monitor pictures
<code>td.RtrCellUnder</code>	Emulates underline video effect for monitor picture
<code>tr.RtrShowNoBriefH1</code>	Header text in tabular output
<code>tr.RtrShowNoBriefH2</code>	Subhead text in tabular output
<code>td.RtrShowNoBriefLabelCell</code>	Table cell label text
<code>td.RtrShowNoBriefValueCell</code>	Table cell value text
<code>table.RtrMoniTable</code>	Tabular format for monitor pictures
<code>table.RtrShowTable</code>	Tabular format for other tables
<code>table.RtrHdrText</code>	Tabular format for monitor picture headers
<code>tr.RtrMonTableHdr</code>	Header rows for monitor tabular output
<code>tr.RtrShowTableHdr</code>	Header rows of other tabular output

(continued on next page)

Table B–1 (Cont.) RTR Style Names

Style Name	Usage
a.RtrPopupLink	Links used to indicate available popup help text
h3.RtrNodeName	Style used by headers (table of contents, index, and node entries) when displaying results in a multi-node command environment
hr.RtrNodeBreak	Style of the horizontal rule used to separate sections of the display in a multi-node command environment

B.1.2 Examples

The following example changes the font family to the browser default serif font, and displays a corporate logo at the top-right corner of the page:

```
<style type="text/css">
  body { font-family: serif;
        background-image:      url(http://your-server/logo.gif);
        background-position:  right top;
        background-repeat:    no-repeat; margin-top: +1in;}
  div.RtrMoniText { line-height: 150%; border-style: ridge;
        margin-left: 20; margin-right: 20 }
  p.RtrMoniText { margin-left: 10; margin-right: 10 }
  tr.RtrRowOdd{ background: rgb(204,204,255);}
  td.RtrCellBlink{ color: red; font-weight: bold;}
  td.RtrCellReverse{ color: white; background-color: gray;}
  td.RtrCellBold{ font-weight: bold;}
  td.RtrCellUnder{ text-decoration: underline;}
  tr.RtrShowNoBriefH1{ background: "#FFCCFF"; }
  tr.RtrShowNoBriefH2{ background: "#CCFFCC"; }
  td.RtrShowNoBriefLabelCell{ text-align: right; }
  td.RtrShowNoBriefValueCell{ text-align: bottom; color: "#49D6B6"; }
  table.RtrMoniTable{ width="100%"; }
  table.RtrShowTable{ width="100%"; }
  table.RtrHdrText{ width="100%"; text-align: center; font-weight: bold;}
  tr.RtrMonTableHdr{ background-color: silver;}
  tr.RtrShowTableHdr{ background-color: silver; text-align: left; font-weight: bold;}
</style>
```

Customizing the RTR Web Browser Interface

B.2 Server Security

B.2 Server Security

RTR performs both client and user verification.

B.2.1 User Authentication

Note

A list of usernames is presented when you first access the RTR Administrator. Once you select a username and the security dialog box requests a username and password, be sure to type **exactly** the same username as the one you selected. Do not prefix or suffix the username with a domain name or any other information.

Also be sure to type the same password you use for logging into that system with that username. For example, usually you must log in with that username to start the RTR HTTP server. During that login process you must enter a password. Enter **exactly** this same password in the RTR security dialog box.

If you enter an incorrect username or password too many times, the security features of RTR will block that username for some time as a preventive measure. If this blocking is triggered, you can wait until RTR has quit blocking that username or you can stop and restart the RTR HTTP server.

The HTTP server client will request user credentials, as shown in Figure 1–3.

Enter a username and password for an account for which the RTR HTTP has been enabled. Windows users may enter the username in the format domain-name\user-name.

To reduce the overhead of accessing the host system user authorization facilities, the server caches user credentials for a period of 90 seconds. During this time it will not revalidate user credentials against the operating system. If you change your password, wait 90 seconds before submitting it to the RTR server.

In addition to validating the supplied credentials, the server ensures that all HTTP requests are received by a command server running under the validated username. Username/password validation errors are logged to the RTR log file.

B.2.2 User Credentials Caching

The RTR web server usually caches valid client credentials to avoid the overhead of validating each access with the operating system. Since only one set of credentials is cached, users who present different sets of credentials (for example, from different browser sessions using different Windows domains) will experience unexpected authorization failures. To turn off client credential caching, set the following environment variable: `RTR_PASSWORD_CACHE_DISABLE`. After a username/password combination has been entered, it is cached until you close your browser. To log in as a different user, close your browser and then reopen it.

B.2.3 Break-in Detection and Evasion

The server attempts to detect a password probing attempt by monitoring the rate of user authentication errors. This is achieved by counting the errors that occur in a time window. This count is maintained for each connecting client node. If the count exceeds a threshold, the server refuses to accept subsequent connections from the client node concerned for a certain time interval. Errors that remain at the end of the counting window are forgiven, and a new window and count are started. The following table shows the default times and counts and the names of environment variables that may be used to specify customized values.

Description	Environment Variable	Default Value
Counting window period	<code>RTR_LGI_WINDOW</code>	300 seconds
Max. number of user authentications errors tolerated in window	<code>RTR_LGI_BRK_LIM</code>	5
Time during which server refuses connections from evaded client	<code>RTR_LGI_HID_TIM</code>	300 seconds

RTR XA Support

This appendix explains how RTR can be used with an X/OPEN Distributed Transaction Processing (DTP) conformant Resource Manager.

C.1 Introduction

The X/OPEN Distributed Transaction Processing (DTP) architecture defines a standard interface that lets application programs share resources provided by resource managers. The XA interface uses the two-phase commit protocol to commit transactions, and is a system-level, bidirectional interface between the transaction manager (TM) and the resource manager (RM). In the RTR environment, RTR is the transaction manager and database software such as ORACLE8 is the resource manager.

Without XA, an RTR application must deal with replayed transactions after server recovery delivered with `rtr_mt_msg1_uncertain`; the application has to check if the transaction has been committed to the database. With XA, the application does not need to be concerned with this problem.

The XA library is an external interface that enables a transaction manager to coordinate global transactions. These can include:

- Opening a resource manager
- Starting a transaction
- Rolling back a transaction
- Preparing and committing a transaction
- Closing a resource manager

With XA, RTR can connect directly to a resource manager such as ORACLE8.

RTR XA Support

C.2 Invoking RTR XA Support

C.2 Invoking RTR XA Support

Starting with RTR Version 4.0, you can invoke RTR XA support in an application without modifying the RTR API. This section shows how to use and invoke RTR XA support within an ORACLE environment.

C.2.1 Registering a Resource Manager

You must register an instance of an RM with RTR. The RM instance name will be used by RTR to identify the specific database. Refer to the ORACLE administrator's reference manual for the appropriate `open_string` and `xaswitch` name.

```
RTR> REGISTER RM db_name1_rm
      /library_path="/opt/oracle8/lib/libclntsh.so"
      /open_string="Oracle_XA+Acc=P/Scott/Tiger+db=db_name1"
      /xaswitch=xaosw

RTR> REGISTER RM db_name2_rm
      /library_path="/opt/oracle8/lib/libclntsh.so"
      /open_string="Oracle_XA+Acc=P/Scott/Tiger+db=db_name2"
      /xaswitch=xaosw
```

Note

You can only register an RM on an RTR backend.

Threaded RTR

When using the threaded version of RTR with Oracle, Oracle 8.1.5 is required.

C.2.2 Associating a Resource Manager with a Facility

All resource managers that will be accessed by a facility must be specified when the facility is created. During a crash, all doubtful transactions associated with these resource managers will be processed and recovered. Once an RM is associated with a given facility, the same RM cannot be associated with another facility.

```
RTR> CREATE FACILITY facility_name/router=.../backend=...
      /resource_manager=(db_name1_rm,db_name2_rm)
```

C.2.3 Binding a Resource Manager with a Partition

You must bind the specific resource manager with an RTR partition when the partition is created. This allows RTR to manage transactions accessing this partition down to the underlying RM via the XA protocol. The XA-managed attribute for the partition remains until the partition goes away.

An RM can be bound with only one partition. Once an RM is associated with a partition, the RM cannot be associated with another partition.

```
<RTR > CREATE PARTITION db_name1_part/resource_manager=db_name1_rm/...  
<RTR > CREATE PARTITION db_name2_part/resource_manager=db_name2_rm/...
```

Note

This feature is supported only in RTR Version 4.0 and later.

C.2.4 Opening an RTR Channel

Starting with RTR Version 4.0, when a server application opens a new channel it does not have to specify the RTR_F_OPE_XA_MANAGED flag and RM name along with the RM's attributes such as open_string in order to invoke RTR XA service. The server application just has to specify the name of a partition that is associated with a specific RM, provided that the user specifies an RM name when creating the partition. All transactions processed through this channel will be managed by the RTR XA service. For an example of opening an RTR channel with XA, see the *HP Reliable Transaction Router C Application Programmer's Reference Manual* rtr_open_channel call.

C.3 MONITOR XA

This command monitors the internal status of XA interface activities. It displays counters containing information such as the number of XA calls, call status (success or failure), and the number of read-only transactions. It provides counts for the open, close, start, end, prepare, commit, rollback, and recovery commands.

Command Syntax: MONITOR XA

C.4 Microsoft DTC Support

RTR for Windows is interoperable with the Microsoft Distributed Transaction Controller (DTC). DTC is supported via the RTR XA software architecture. That is, with the XA protocol, RTR users can develop application programs to update MS SQL Server databases, MSMQ, or other Microsoft resource managers under the control of a true distributed transaction.

This is possible because RTR (as a distributed transaction manager) is able to directly communicate with MS DTC to manage a transaction or perform a recovery via the XA protocol. For each standard XA call received from RTR, MS DTC will translate it into a corresponding OLE transaction call that SQL Server or MSMQ can use to update databases.

D

RTR Utility Messages

This appendix describes the messages that can be returned by the RTR utility. The following table gives the meaning of the various error codes.

Code	Meaning	Description
S	Success	The system has successfully performed your request. In some cases, the command processing continues after the message is issued.
I	Information	The system has performed your request. The message provides information about the process.
W	Warning	The command may have performed some, but not all, of your request. The message may suggest that you verify the command or the program output.
E	Error	The output or program result is incorrect, but the system may attempt to continue execution.
F	Fatal (Severe)	The system cannot continue to execute the request.

D.1 Utility Error Messages

`%RTR-F-ABKEYW`

Ambiguous qualifier or keyword - supply more characters

Explanation: Too few characters were used to truncate a keyword or qualifier name to make the keyword or qualifier name unique.

`%RTR-F-ABKEYW`, Ambiguous qualifier or keyword - supply more characters

Explanation: Too few characters were used to truncate a keyword or qualifier name to make the keyword or qualifier name unique.

`%RTR-F-ABVERB`, Ambiguous command verb - supply more characters

Explanation: Too few characters were used to truncate a command name to make the command name unique.

RTR Utility Messages

D.1 Utility Error Messages

%RTR-E-ACCTOOBIG, ACCESS string is too long

Explanation: The string supplied with the /ACCESS qualifier on the OPEN CHANNEL command was too long.

%RTR-F-ACPINSRES, The RTRACP has insufficient resources

Explanation: The RTRACP was unable to perform an operation due to an unusual condition. This is most probably a resource issue, for example when the ACP cannot create an additional shared memory segment due to quota or system configuration limits. This may also occur on some platforms when an application connects to a newly restarted ACP before all applications have finished using the process counter shared memory segments belonging to a previous ACP.

The RTR log file usually contains more details.

%RTR-E-ACPNOTVIA, RTRACP is no longer a viable entity, restart RTR or application

Explanation: The RTRACP process has terminated unexpectedly. This status may also be reported by a process that has encountered an IPC error when communicating with the RTRACP. Check the RTR log file for additional information.

%RTR-I-ALRDYINSTATE, Partition is already in the desired state

Explanation: Returned following an attempt to change the state of shadowing for a partition when the partition was already in the desired state.

%RTR-E-AMBIGDISP, Ambiguous monitor file name, [A]

Explanation: The filename [A] could refer to more than one monitor file. Please supply more characters.

%RTR-F-AMBROUNAM, Ambiguous API routine name for CALL - supply more characters

Explanation: The parameter for the CALL command is the name (or part of a name) of an RTR API routine. This allows the user to type, for example, "rtr call accept" instead of "rtr call rtr_accept_tx". This message is issued if the user has specified part of an API routine name that matches more than one routine.

RTR Utility Messages

D.1 Utility Error Messages

`%RTR-F-BADDSKWRI`, Unable to create/extend a journal file - disk write failed

Explanation: An attempt to create or extend a journal file on disk failed. Check that the disk(s) you are using for journals have sufficient free space and that you have not exceeded your quota.

`%RTR-E-BADINTLEN`, Integer keys of length [A] are not supported - use 1, 2, 4 or 8

Explanation: Keys of type integer are constrained in length to one of 1, 2, 4, 8.

`%RTR-E-BADKEYLEN`, Key-type string [A] of [A] ambiguous - use string, signed or unsigned

Explanation: The input string is too short to identify the required type unambiguously. Input more characters. Try string, signed, or unsigned.

`%RTR-E-BADKEYTYPE`, Key-type string [A] of [A] invalid - try string, signed or unsigned

Explanation: The input key type is unrecognised. Try one of string, signed, unsigned.

`%RTR-E-BADKEYWORD`, Segment [A] keyword [A] unrecognised - use type, length, offset, low_ or high_bound

Explanation: The indicated text is not a recognised keyword of the key segment syntax. Use type, length, offset, low_bound or high_bound.

`%RTR-E-BADKEYWORDL`, Segment [A] keyword string [A] ambiguous - use type, length, offset, low_ or high_bound

Explanation: Insufficient characters have been entered to allow unambiguous resolution of the keyword. Enter more text. Use type, length, offset, low_bound or high_bound.

`%RTR-E-BADOP`, Unable to complete operation @[A] line [A]

Explanation: Processing definition incomplete or undefined - report occurrence with supporting information on current command to RTR Engineering.

`%RTR-F-BADOUTFIL`, Cannot open file specified with /OUTPUT

Explanation: The file specified with the /OUTPUT qualifier cannot be opened.

RTR Utility Messages

D.1 Utility Error Messages

%RTR-E-BADPRTSTATE, Disallowed attempt to make an illegal or undefined partition state transition

Explanation: Returned following an attempt to make an illegal or undefined partition state transition. The specified state transition is invalid.

%RTR-E-BADRTRINS, RTR is not correctly installed

Explanation: RTR is not correctly installed. Refer to the RTR Installation Guide for details of how to install RTR.

%RTR-W-BADTRVERSION, Function not supported in version of RTR on router node

Explanation: RTR is running in a mixed-version environment. A router running an older version of RTR does not recognize the operation requested of it by a newer version of RTR running on another node. Usually this indicates some inconsistency in the rolling upgrade procedure. Consult the Release Notes and RTR Installation Guide for instructions on rolling upgrades.

%RTR-E-BENOTALL032, Not all backends are at the minimum required version of V3.2

Explanation: Cannot perform the requested action because not all routers are at a minimum version of V3.2.

%RTR-E-CANTSTOP, RTR could not be stopped

Explanation: RTR cannot be stopped under the present circumstances.

%RTR-E-CHAALROPE, Channel [A] is already open in this window

Explanation: An RTR channel of this name is already open in this window.

%RTR-F-CHANOTOPE, Channel not opened

Explanation: Channel was not opened. Check channels using the SHOW CHANNEL command.

%RTR-F-CHKDSKSP, Check for device full or inadequate disk quota

Explanation: Journal creation fails because there is not enough device space/disk quota. Increase device space/disk quota and create the journal.

%RTR-E-CHLDERR, RTR failed to create child process [A]

Explanation: RTR was not able to create a child process. Please check the log file for additional details and platform specific information.

RTR Utility Messages

D.1 Utility Error Messages

%RTR-E-CHNALRDEC, Channel [A] is already declared

Explanation: The channel specified with the /CHANNEL qualifier on a CALL RTR_OPEN_CHANNEL command has already been declared.

%RTR-E-CHNOTACTIVE, Channel does not have active transaction running

Explanation: No transaction is currently active on this channel. This can occur only in the V2 command environment, and is retained for compatibility with previous versions of RTR.

%RTR-E-CLASSREQ, At least one data-class definition required

Explanation: At least one data-class definition is required in a call to rtr_request_info.

%RTR-E-CLOSEPEND, Send failed due to close pending on channel - call rtr_receive_message

Explanation: Sending of data to the RTRACP has been aborted due to the presence of an undelivered mt_closed message on the channel. The application may retrieve the reason for the channel closure by calling rtr_receive_message to receive the mt_closed message.

%RTR-I-CMDIGNORE, Command ignored for defined facility role

Explanation: Indicates that the command was ignored on the executing node since it has no significance for the role defined.

%RTR-I-CMDNOTWRK, [A]-command not implemented

Explanation: This command is not currently implemented.

%RTR-E-CMDRESDEV, Command reserved to RTR development

Explanation: An unsupported command was issued.

%RTR-E-CMDTOOLON, Command too long

Explanation: Command was longer than 256 characters.

%RTR-E-CNCTERR, Connect acceptance error with error message [A] in node [A]

Explanation: The following are the possible reasons for the error :The node receives the request but while trying to accept the request it has got the following problems hence the accept is rejected 1. invalid message size (or if it is less than the minimum length) 2. insufficient memory to store the connection information. 3. connection request from invalid remote id 4. link is not configured in the facility.

RTR Utility Messages

D.1 Utility Error Messages

%RTR-E-CNTCRJOU, Cannot create journal directory

Explanation: Cannot create journal directory. Check that RTR has sufficient permission, disk space and disk quota, and that the parent directory exists and is writable. There may be more details in the log.

%RTR-S-COMARESEN, Commands sent by default to node [A]

Explanation: Displays the default nodes for command execution after issuing a SET ENVIRONMENT or SHOW ENVIRONMENT command.

%RTR-E-COMNOTFOU, Command not found [A], use RECALL/ALL

Explanation: The command [A] requested with RECALL did not match any command in the recall buffer.

%RTR-E-COMNUMMUS, Command number must be between 1 and [A]

Explanation: The command number requested with RECALL was not in the allowed range (1 to [A]).

%RTR-F-CONFLICT, Illegal combination of command elements - check documentation
n [A]

Explanation: Two or more keywords, qualifiers or parameters that cannot be used in combination were used in the same command line.

%RTR-E-CONREMNODE, [A]

Explanation: Connection to a remote node failed. The reason commonly is either a connection refused by the remote node or a connection timeout if the remote node is down.

%RTR-S-CPCREATED, ConnectionPool [A] created

Explanation: Displays the name [A] of the ConnectionPool that was successfully created after issuing a CREATE CONNECTIONPOOL command.

%RTR-S-CPDELETED, ConnectionPool [A] deleted

Explanation: ConnectionPool has been successfully deleted after issuing a DELETE CONNECTIONPOOL command.

%RTR-E-CPINUSE, ConnectionPool [A], is currently in use

Explanation: The ConnectionPool name specified in a CREATE DATASOURCE or MODIFY DATASOURCE command is already associated with another DataSource.

RTR Utility Messages

D.1 Utility Error Messages

%RTR-S-CPMODIFIED, ConnectionPool [A], has been modified

Explanation: Confirms that the MODIFY CONNECTIONPOOL command has successfully modified the required parameter of the RTR Connection Pool.

%RTR-E-CPNOTFOU, ConnectionPool [A], not found

Explanation: RTR ConnectionPool not found.

This status may be returned by the MODIFY CONNECTIONPOOL, DELETE CONNECTIONPOOL and SHOW CONNECTIONPOOL commands.

The can be caused by one of the following:

- a) You have not issued an RTR CREATE CONNECTIONPOOL command.
- b) The ConnectionPool has been deleted.

%RTR-E-CPPROPFMAT, The format of ConnectionPool [A]'s property is wrong
- use key:val format

Explanation: The format of a ConnectionPool property is not proper. The defined format is "/property=(key1:val1, key2:val2,...)".

This status may be returned by the MODIFY CONNECTIONPOOL and CREATE CONNECTIONPOOL commands.

%RTR-S-CPTESTED, ConnectionPool [A] tested successfully

Explanation: The ConnectionPool has been successfully tested after issuing a CREATE CONNECTIONPOOL/TEST command.

%RTR-I-CPTESTFAIL, ConnectionPool [A] test failed

Explanation: The testing of ConnectionPool failed after issuing a CREATE CONNECTIONPOOL/TEST command.

%RTR-E-CTRHSTNOTSTART, Counter host not started

Explanation: The performance counter host could not be started. Check the RTR log file for additional information.

%RTR-S-CTRHSTSTART, Counter host started

Explanation: The performance counter host was successfully started.

%RTR-I-DEQDATA, Received data ([A] bytes) [A]

Explanation: Displays the dequeued data [B] and its length in bytes [A].

RTR Utility Messages

D.1 Utility Error Messages

%RTR-F-DFSDISK, Disk is served by DFS

Explanation: An attempt was made to create a journal on a disk served by DFS. RTR does not support journals on DFS-supported disks.

%RTR-I-DISABMOD, [A] mode disabled

Explanation: Displays the name [A] of the mode that was disabled after issuing a SET MODE command.

%RTR-S-DISITMCLR, [A] monitor item(s) cleared

Explanation: Indicates how many monitor items [A] were successfully cleared after issuing a CLEAR command.

%RTR-E-DISKACCDEN, Disk access denied - privileges required to create a journal in the directory

Explanation: The journal directory exists, but the RTR process does not have sufficient access permission to create journal files in it.

%RTR-W-DISKALL, Disk is not available to RTR

Explanation: An attempt was made to create a journal on a disk which is allocated to a different process.

%RTR-W-DISKMNTVER, Disk is currently under mount verification

Explanation: An attempt was made to create a journal on a disk which is in mount verification. Try later.

%RTR-W-DISKMOUFOR, Disk is mounted foreign

Explanation: An attempt was made to create a journal on a disk which is mounted foreign. Please check disk for proper mount status.

%RTR-W-DISKNOTMOU, Disk is not mounted

Explanation: An attempt was made to create a journal on a disk which is not mounted. Please check disk for proper mount status.

%RTR-W-DISKSSM, Disk is a member of a shadow set

Explanation: An attempt was made to create a journal on a disk which is a member of a shadow set. RTR cannot locate journals on individual shadow set members.

%RTR-W-DISKSWL, Disk is software write locked

Explanation: An attempt was made to create a journal on a disk which is software write locked.

RTR Utility Messages

D.1 Utility Error Messages

%RTR-I-DROPPEDBE, Implicitly dropped %u backend(s) from facility [A]

Explanation: This informational message states that [A] backends were implicitly dropped from facility [B].

The router role was trimmed from a node that also participates as a frontend or backend. The node is therefore no longer acting as a router, and will not remember links to backends. If the node is extended to participate in the router role once again, the lost backends will need to be added. For example, `EXTEND FACILITY/ROUTER=this_node/BACKEND=(lost_backends)`.

%RTR-I-DROPPEDFE, Implicitly dropped %u frontend(s) from facility [A]

Explanation: This information message states that [A] frontends were implicitly dropped from facility [B].

The router role was trimmed from a node that also participates as a frontend or backend. The node is therefore no longer acting as a router, and will not remember links to frontends. If the node is extended to participate in the router role once again, the lost frontends will need to be added. For example, `EXTEND FACILITY/ROUTER=this_node/FRONTEND=(lost_frontends)`.

%RTR-S-DSCREATED, Datasource [A] created

Explanation: Displays the name [A] of the DataSource that was successfully created after issuing a `CREATE DATASOURCE` command.

%RTR-S-DSDELETED, Datasource [A] deleted

Explanation: DataSource has been successfully deleted after issuing a `DELETE DATASOURCE` command.

%RTR-E-DSKNOTSET, Specified disk not part of the journal disk set

Explanation: A disk specified as part of a `MODIFY JOURNAL` command was not part of the original disk set specified in the `CREATE JOURNAL` command.

%RTR-S-DSMODIFIED, Datasource [A] has been modified

Explanation: Confirms that the RTR DataSource has successfully modified the required parameter after issuing a `MODIFY DATASOURCE` command.

RTR Utility Messages

D.1 Utility Error Messages

%RTR-E-DSNOTFOU, DataSource [A] not found

Explanation: RTR DataSource not found.

This status may be returned by the MODIFY DATASOURCE, DELETE DATASOURCE and SHOW DATASOURCE commands.

This can be because:

- a) You have not issued an RTR CREATE DATASOURCE command.
- b) The DataSource has been deleted.

%RTR-E-DTXNOSUCHRM, There is no such RM registered

Explanation: There is no such Resource Manager (RM) registered.

%RTR-W-DTXREADONLY, The transaction branch was read-only and has been committed

Explanation: The Resource Manager (RM) will simply return a warning indicating the transaction branch was read-only and has been committed already.

%RTR-E-DTXRMBUSY, DTX RM is still in use by RTR

Explanation: The DTX Resource Manager (RM) is still referenced by at least one RTR facility or open channel.

%RTR-E-DTXRMEXISTS, The DTX RM has already been registered

Explanation: The Resource Manager (RM) has already been registered.

%RTR-E-DTXTOOMANYRMS, Too many RMs or instances of an RM have been registered

Explanation: The RTRACP has registered too many (> 16) Resource Manager (RM) instances.

%RTR-E-DTXXAERPROTO, RTR invoked an xa call in an improper context

Explanation: RTR called the XA routine in an improper context, for example, calling xa_commit call without calling xa_prepare.

%RTR-E-DUPCPNAME, Duplicate ConnectionPool name, [A]

Explanation: The ConnectionPool name specified in a CREATE CONNECTIONPOOL command already exists in the system.

%RTR-E-DUPDSNAME, Duplicate DataSource name, [A]

Explanation: The DataSource name specified in a CREATE DATASOURCE command already exists in the system.

RTR Utility Messages

D.1 Utility Error Messages

%RTR-F-DUPJOUFIL, Duplicate RTR journal file found - remove duplicate or use CREATE JOURNAL /SUPERSEDE

Explanation: A duplicate RTR journal file has been found. This status may be returned by the CREATE FACILITY and SHOW JOURNAL commands.

The probable cause is a system management error. A user has copied a journal file or a disk containing a journal file. RTR can now see both the original and the copy and does not know which to use.

To correct this, do one of the following:

(a) Check the log for the relevant filenames, and delete or move the duplicate journal file, or

(b) Reissue the CREATE JOURNAL /SUPERSEDE command (in this case any recovery information in the old journal is lost).

%RTR-E-DUPLPARTNAME, Duplicate partition name

Explanation: Duplicate partition argument.

%RTR-E-DUPLRMNAME, Duplicate RM partition name

Explanation: Duplicate partition argument.

%RTR-E-DUPNODNAM, Duplicate node name, [A]

Explanation: The node name list specified with the /FRONTEND, /ROUTER or /BACKEND qualifiers on a CREATE FACILITY command contained the node name [A] more than once.

%RTR-E-DUPSPNAME, Duplicate ServiceProvider name, [A]

Explanation: The ServiceProvider name specified in a CREATE SERVICEPROVIDER command already exists on the system.

%RTR-E-EARVINC, Early vote caused inconsistent transaction state

Explanation: Early Vote option, which by default is enabled when NORECOVERY partition option is selected, causes secondary ACP process to vote on a transaction even before primary does the same.

Loss of primary site before voting on the active transactions results in inconsistent transaction states at surviving shadow site. RTR aborts such transactions and passes status information to the applications.

%RTR-E-EMPTYREQ, Request_info list is empty

Explanation: An empty list was supplied to rtr_request_info.

RTR Utility Messages

D.1 Utility Error Messages

%RTR-I-ENABMOD, [A] mode enabled

Explanation: Displays the name [A] of the mode that was enabled after issuing a SET MODE command.

%RTR-E-ENODNANAM, DECnet definition required, but not found for node [A]

Explanation: A node name was specified in a context that required a successful lookup for the DECnet address, but none was available. This can occur when DECnet is explicitly specified through use of a node name prefix ("dna."), or when DECnet is the only enabled network transport. Check the network node name database on the local node, and the network name server (DNS).

%RTR-E-ENOIPNAM, IP definition required, but no host definition found for [A]

Explanation: A host name was specified in a context that required a successful lookup for the IP address, but none was available. This can occur when TCP is explicitly specified through use of a node name prefix ("tcp."), or when IP networking is the only enabled network transport. Check the host name database on the local node, and the network name server (DNS).

%RTR-F-ENOTTRANSPORTS, No network transports available

Explanation: No network transport are available. Most likely cause is the manipulation of the transport protocols allowed to RTR.

%RTR-F-ERRACCDIR, Directory [A], cannot be accessed or opened

Explanation: A directory cannot be accessed or opened.

%RTR-E-ERRACCFIL, Error accessing file [A]

Explanation: Displays the name [A] of a file that the RTR utility was unable to access.

%RTR-E-ERRACCMBX, Error accessing mailbox

Explanation: An error occurred whilst accessing a mailbox. The subsequent message gives more details.

RTR Utility Messages

D.1 Utility Error Messages

%RTR-E-ERRACCNOD, Error accessing node [A]

Explanation: An error occurred whilst accessing node [A]. If you were using the /NODE or /CLUSTER qualifier to issue a remote command please check that you are able to execute simple non-RTR remote shell or DECnet commands on the remote node. RTR remote commands will not work unless remote shell software is installed and proxy and rhost settings are correctly configured. Also check that both nodes have the same RTR_PREF_PROT value on platforms that can use both DECnet and TCP/IP.

%RTR-E-ERRACCTAB, Error accessing tables

Explanation: The configuration tables could not be accessed. The subsequent message gives more details.

%RTR-E-ERRCREMBX, Error creating mailbox

Explanation: An error occurred whilst creating a mailbox. The subsequent message gives more details.

%RTR-E-ERRDELMBX, Error deleting mailbox

Explanation: An error occurred whilst deleting a mailbox. The subsequent message gives more details.

%RTR-E-ERRGETNOD, Error obtaining information for node [A]

Explanation: An error occurred whilst trying to look up node [A] in the DECnet database. The subsequent message gives more details.

%RTR-E-ERRINIACS, Unable to initialize tables

Explanation: The configuration tables could not be initialized. The subsequent message gives more details.

%RTR-F-ERRJOUNAM, Error in journal file name -
CREATE JOURNAL/SUPERSEDE and submit prob. report

Explanation: An RTR journal file has been found which has an incorrect name format. This may be an RTR error, so submit a problem report. This status may be returned by the CREATE FACILITY and SHOW JOURNAL commands.

Reissue the RTR CREATE JOURNAL command before restarting RTR.
Use CREATE JOURNAL/SUPERSEDE.

%RTR-E-ERROPEFIL, Error opening file [A]

Explanation: Displays the name [A] of a file that the RTR utility was unable to open.

RTR Utility Messages

D.1 Utility Error Messages

%RTR-F-ERROPEJOU, Error opening journal file

Explanation: An error occurred while opening a journal file.

%RTR-E-ERRSTAACP, Unable to start ACP

Explanation: The RTRACP process could not be started when a START RTR command was issued. The subsequent message gives more details.

%RTR-E-ERRSTARCH, Unable to start remote client handler

Explanation: The RTR remote client handler process could not be started when a START REMOTE_CLIENT_HANDLER command was issued. The subsequent message gives more details.

%RTR-E-EVTNAMILL, Unknown event name, [A]

Explanation: The /EVENT qualifier on the SYS\$DCL_TX_PRC command specified an out-of-range event number.

%RTR-W-EXCHANNELCNT, SYSGEN parameter CHANNELCNT too small for the requested number of processes and links

Explanation: The value of the OpenVMS SYSGEN parameter CHANNELCNT is too small to allow RTR to handle the requested number of application processes and links. RTR will start, but fewer application processes can be handled than specified. Review the values of the /PROCESS and /LINK qualifiers to the START RTR command. CHANNELCNT should be greater than 30 plus the number of links plus twice the number of processes specified.

%RTR-W-EXCMAXSIZ, Create/Modify Journal failed - maximum journal size should not exceed [A] Blocks

Explanation: The user cannot create or modify an RTR Journal using the CREATE/MODIFY JOURNAL command with a Journal Size that exceeds the maximum size allowed by RTR.

%RTR-W-EXFREEPAGE, Requested page file quota exceeds free space in page files

Explanation: The page file quota specified on OpenVMS for the RTRACP process exceeds the current free space in the page file. RTR will start, but may have access to fewer resources than desired. Review the sizing qualifiers to the START RTR command (including the defaults) - you may need to increase the size of the system page file(s).

RTR Utility Messages

D.1 Utility Error Messages

%RTR-W-EXMAXPROCESSCNT, SYSGEN parameter MAXPROCESSCNT too small for the requested number of processes

Explanation: The value of the OpenVMS SYSGEN parameter MAXPROCESSCNT is too small to allow RTR to handle the requested number of application processes. RTR will start, but fewer application processes can be handled than specified. Review the value of the /PROCESS qualifier to the START RTR command. MAXPROCESSCNT should be greater than 50 plus the number of processes specified.

%RTR-F-EXPNAMEUSED, NAME [A] has already been used

Explanation: The REMEMBER EXPRESSION /NAME [A] has already been used. This REMEMBER EXPRESSION command has been ignored.

%RTR-E-EXPNAMILL, Expression name [A] contains illegal character "[A]"

Explanation: The expression name [A] specified by the REMEMBER EXPRESSION command contains the specified illegal character. Legal characters are letters (A to Z), numbers (0 to 9), hyphen (-), and the underscore(_).

%RTR-W-EXPNAMNOTFOUND, EXPRESSION NAME [A] not declared - using default value "1" for SELECT clause

Explanation: The SELECT qualifier contains an expression name [A] that has not previously been declared.

%RTR-W-EXPNAMTRUNCATED, NAME truncated from [A] characters to [A] characters

Explanation: Data in a REMEMBER EXPRESSION /NAME qualifier is too long. The name has been truncated from [A] characters to [A] characters to fit in the appropriate space.

%RTR-E-EXPSYNILL, Expression has illegal syntax, [A] expected n/[A]/

Explanation: The expression is invalid because token [A] was expected but the given token was found.

%RTR-E-EXPTOOCOM, Expression too complex n[A]

Explanation: The expression [A] is too complex to evaluate. Please submit a Problem Report.

RTR Utility Messages

D.1 Utility Error Messages

%RTR-W-EXWSMAX, Requested memory quotas exceed the system limit
WSMAX

Explanation: The command qualifiers on the START RTR command specify a larger physical memory quota than is currently permitted by the operating system limits. RTR will start, but may have access to fewer resources than desired. Raise the system size limit.

%RTR-S-FACADDED, Facility [A] added

Explanation: Displays the name of the facility that was successfully created after issuing an CREATE FACILITY command.

%RTR-E-FACALREXI, Facility already exists, [A]

Explanation: The facility [A] specified with the CREATE FACILITY command already exists.

%RTR-S-FACCREATED, Facility [A] created

Explanation: Displays the name [A] of the facility that was successfully created after issuing a CREATE FACILITY command.

%RTR-S-FACDELETE, Facility [A] deleted

Explanation: Displays the name of the facility that has been deleted after issuing a DELETE FACILITY command.

%RTR-S-FACEXTENDED, Facility [A] extended

Explanation: Displays the name [A] of the facility that was successfully extended (or created) after issuing an EXTEND FACILITY command.

%RTR-E-FACNAMBLA, Facility name is blank

Explanation: An empty string was specified where a facility name was expected.

%RTR-E-FACNAMILL, Facility name [A] contains illegal character "[A]"

Explanation: The facility name [A] contains the identified illegal character. Legal characters are capital letters (A to Z), numbers (0 to 9), dollar (\$) and underscore (_).

%RTR-E-FACNAMLON, Facility name [A] is longer than 30 characters

Explanation: The facility name [A] is too long. The maximum length of a facility name is RTR_MAX_FACNAM_LEN (currently 31). However, 31 character facility names are not supported in recent versions of RTR.

RTR Utility Messages

D.1 Utility Error Messages

%RTR-E-FACNAMSTA, Facility name [A] does not start with a letter

Explanation: The facility name [A] does not start with a capital letter (A to Z).

%RTR-E-FACNOTDEL, Facility [A] cannot be deleted while it has active partitions

Explanation: The specified facility could not be deleted because it has at least one active partition. For a partition to be considered inactive it must either have no servers or be in standby state. Stop any servers running on partitions within the facility on the node where the facility is to be deleted.

%RTR-E-FACPRREQ, Facility and partition name are required to set a transaction in pri_done state

Explanation: The transaction is in the pri_done state; to set it to another state, the user must supply both facility and partition names.

%RTR-I-FACROLEDEL, Node no longer configured for appropriate role

Explanation: This status can be returned as the reason status when a client channel is being shut down because the facility has been deleted or its configuration has been modified to exclude the appropriate role from the set of roles for this node.

%RTR-E-FACTABFUL, The FAC table is full

Explanation: This message is displayed when an CREATE FACILITY command is issued. It indicates that the maximum number of FACILITY to LINK relations has been reached.

%RTR-S-FACTRIMMED, Facility [A] trimmed

Explanation: Displays the name [A] of the facility that was successfully trimmed after issuing a TRIM FACILITY command.

%RTR-E-FDBTABFUL, The FDB table is full

Explanation: This message is displayed when an CREATE FACILITY command is issued. It indicates that the maximum number of facilities has already been reached.

%RTR-E-FENAMELONG, Frontend name string length greater than RTR_MAX_FE_NAM_LEN

Explanation: The supplied value for the frontend name string exceeded the permitted maximum of RTR_MAX_FE_NAM_LEN characters.

RTR Utility Messages

D.1 Utility Error Messages

%RTR-E-FLDNFND, Field [A] not found

Explanation: Field not found in call to `rtr_request_info`.

%RTR-I-FORCEDEXI, Forcing RTR application exit, process [A], PID [A]

Explanation: Displays the name [A] and PID of the processes that were forced to exit due to the execution of a STOP RTR command.

%RTR-F-FUNCNOTSUP, Function not supported

Explanation: Function not supported.

%RTR-I-GRPMODCHG, Group changed from [A] to [A]

Explanation: RTR group changed from the first to the second named.

%RTR-E-GRPNAMILL, Group name [A] contains illegal character "[A]"

Explanation: The group name [A] contains the specified illegal character. Legal characters are letters (A to Z), numbers (0 to 9), dollar (\$), hyphen (-), and underscore (_).

%RTR-I-HIGBNDHEX, High bound is [A] (hex)

Explanation: Displays the high bound of the server key range.

%RTR-E-HLBNCPBTL, Format of help library [A] is unknown

Explanation: The specified help library has an unknown format.

%RTR-I-HLPNOTFND, No help available (help file [A] not found)

Explanation: The help file specified by the RTRHELP environment variable cannot be found or cannot be opened.

%RTR-E-ILLDEVTYPE, Device [A] is unsuitable for journals

Explanation: RTR can only create its journal files on directory structured devices. Reissue the CREATE JOURNAL command specifying a suitable disk. Setting the environment variable RTR_SCAN_ALL may help to overcome this if you are certain that the device is in fact suitable.

%RTR-E-ILLPARTCHAR, Legal characters are alphanumeric, dollar and underscore

Explanation: The partition name contains one or more illegal characters.

%RTR-E-ILLREMDEV, Device [A] contains a node specification

Explanation: RTR cannot create its journal files on remote systems. Reissue the CREATE JOURNAL command specifying a local disk.

RTR Utility Messages

D.1 Utility Error Messages

%RTR-E-INICTXFAIL, The ServiceProvider [A], failed to register initial context in JVM

Explanation: The ServiceProvider name specified in CREATE SERVICEPROVIDER or MODIFY SERVICEPROVIDER failed to register its initial context in JVM, the Java Virtual Machine.

%RTR-E-INSUFPRIV, Insufficient privileges to run RTR

Explanation: More privileges required to run the RTR utility.

%RTR-F-INSVIRMEM, Insufficient virtual memory

Explanation: The application was unable to allocate additional virtual memory.

%RTR-F-INVCHANAM, Invalid chanam argument

Explanation: Invalid channel name (chanam) argument. The maximum length of a channel name is RTR_MAX_CHANAM_LEN (currently 31). Legal characters are alphanumeric, dollar and underscore.

%RTR-F-INVCHANNEL, Invalid channel argument

Explanation: Invalid channel specified.

%RTR-F-INVDEVNAM, Invalid device name length

Explanation: Invalid device name length.

%RTR-F-INVDSDEF, Msglen not consistent with len derived from msgfmt

Explanation: Invalid DSDEF format argument.

%RTR-F-INEVTNUM, Invalid evtnum argument

Explanation: Invalid event number (evtnum) argument.

%RTR-F-INEVTRAN, Invalid evtnum range

Explanation: Invalid event number range in the evtnum argument.

%RTR-E-INVFILNAM, Invalid file name, [A]

Explanation: The specified filename [A] is invalid.

%RTR-F-INVFL4CLI, Invalid flag for client channel

Explanation: Invalid flag for client channel.

%RTR-F-INVFL4SRV, Invalid flag for server channel

Explanation: Invalid flag for server channel.

RTR Utility Messages

D.1 Utility Error Messages

%RTR-F-INVFLAGS, Invalid flags argument

Explanation: Invalid flags argument. An RTR API call was invoked with a combination of flags that had either insufficient, conflicting, or invalid flag bits set. If the RTR API call was made from the command line, then either supply additional qualifiers, or remove conflicting qualifiers.

%RTR-E-INVGETITMS, Invalid getitms argument

Explanation: The getitms argument given to `rtr_request_info()` was invalid.

%RTR-F-INVIMPLCTSTRT, Implicit start transaction disallowed by channel properties

Explanation: An implicit transaction start was attempted on a channel that disallows this operation. Any previous transaction on the channel has either completed or been rejected. Call `rtr_start_tx()` and send the data again.

%RTR-E-INVINFCLA, The given information class does not exist

Explanation: The information class passed to the API call `rtr_request_info()` does not exist.

%RTR-F-INVJOINTXID, Invalid join transaction argument

Explanation: If the `RTR_F_OPE_FOREIGN_TM` flag was specified in the call to `rtr_open_channel`, then the call to `rtr_start_tx` requires a join TX parameter. Also, the `formatID` field of the join TXID must be set to a valid value (not `RTR_XID_FORMATID_NONE`).

%RTR-F-INVKSLENGTH, Invalid ks_length argument

Explanation: Invalid key segment length (`ks_length`) argument. The length of a numeric key must be 1, 2, 4 or 8. The length may not be zero. The entire key must fit within the message.

%RTR-F-INVKSTYPE, Invalid ks_type argument

Explanation: Invalid key segment type (`ks_type`) argument.

%RTR-E-INVMONFILECMD, Command not allowed inside the monitor file n[A]

Explanation: The specified monitor file contained an invalid command [A]. This may be caused by omitting the continuation character (-) on the end of a line that is to be continued.

RTR Utility Messages

D.1 Utility Error Messages

%RTR-F-INVMSGFMT, Invalid format argument

Explanation: Invalid message format (msgfmt) argument.

Possible reasons include the use of an invalid character or expression in the format string, or a mismatch in the number of bytes specified by the format string and the message length argument. The maximum length of a format string is RTR_MAX_MSGFMT_LEN (currently 8192).

%RTR-F-INVMSGLEN, Invalid msglen argument

Explanation: Invalid message length (msglen) argument. The maximum size of an RTR message is RTR_MAX_MSGLEN (64000). Zero length messages are permitted.

%RTR-E-INVMSGSIZE, Signed and unsigned data must be 1, 2, 4 or 8 bytes

Explanation: The size of a numeric key segment must be 1, 2, 4, or 8 bytes.

%RTR-F-INVNUMSEG, Invalid numseg argument

Explanation: Invalid number of key segments (numseg) argument. The maximum number of segments in key is RTR_MAX_NUMSEG (currently 20).

%RTR-E-INVOBJCT, Specified object type invalid for managed object request

Explanation: An invalid management object type was the target of an rtr_set_info() command. Check your program and the RTR C Application Programmer's Reference Manual for valid managed object types.

%RTR-F-INVOP4CLI, Invalid operation for client channel

Explanation: Invalid operation for client channel.

%RTR-F-INVOP4SRV, Invalid operation for server channel

Explanation: Invalid operation for server channel.

%RTR-F-INVPKEYSEG, Invalid pkeyseg argument

Explanation: Invalid key segment pointer (pkeyseg) argument.

%RTR-F-INVRCPNAM, Invalid rcpname argument

Explanation: Invalid recipient name (rcpname) argument. The maximum length of a broadcast recipient name is RTR_MAX_RCPNAM_LEN (currently 31). Some versions also tolerate 32 characters for compatibility with V2.

RTR Utility Messages

D.1 Utility Error Messages

%RTR-F-INVREASON, Invalid reason argument

Explanation: Invalid reason argument.

%RTR-E-INVRMNAME, Invalid resource manager name

Explanation: Invalid resource manager name.

%RTR-E-INVSELITM, Invalid selitm argument

Explanation: An invalid character was found in the selitm argument given to `rtr_request_info()`, or selitm was of type OBJECT.

%RTR-E-INVSELLEN, Invalid sellen argument

Explanation: The sellen argument given to `rtr_request_info()` was invalid.

%RTR-E-INVSELVAL, Invalid selval argument

Explanation: The selval argument given to `rtr_request_info()` was invalid.

%RTR-E-INVSTATCHANGE, Invalid to change from current state to the specified state

Explanation: The SET TRANSACTION command cannot perform the required change.

%RTR-F-INVSVRCLIFLG, Either both /Client and /Server flags were supplied or they were missing

Explanation: Either /Client and /Server flags were both supplied or none were supplied. Please enter the desired flag for your command.

%RTR-F-INVWAKEUP, Invalid wakeup argument

Explanation: Invalid wakeup argument. The wakeup must be a void function with no arguments, or NULL.

%RTR-E-ITMALREXI, There is already something displayed at x = [A], y = [A]

Explanation: Invalid coordinates were specified on a DISPLAY command within a display file. There already is an item at point x,y.

%RTR-E-ITMLSTTOOBIG, Item-list got too big

Explanation: A MONITOR file is so complex that the item list is too big to pass to `rtr_request_info`.

RTR Utility Messages

D.1 Utility Error Messages

%RTR-F-IVKEYW, Unrecognized keyword - check validity and spelling
n [A]

Explanation: A keyword specified in a command is not valid for the command. The rejected portion of the command is displayed between backslashes.

%RTR-F-IVQUAL, Unrecognized qualifier - check validity, spelling, and
placement
n [A]

Explanation: An invalid qualifier is specified.

%RTR-F-IVVERB, Unrecognized command verb - check validity and spelling
n [A]

Explanation: The first word in the command is not a valid CLI command or a name equated with a command. The rejected portion of the command is displayed between backslashes.

%RTR-E-JNDIINUSE, JNDI [A], is currently in use

Explanation: The JNDI name specified in a CREATE DATASOURCE /CONNECTIONPOOL or MODIFY DATASOURCE /CONNECTIONPOOL command is already associated with another DataSource/ConnectionPool.

%RTR-E-JNDIREGFAIL, [A] [A] failed to register with JNDI in JVM

Explanation: Error occurs while registering with JNDI in JVM.

%RTR-E-JOUACCDEN, No access to journal for attempted operation:
permission denied

Explanation: Could not access journal file due to insufficient privileges.

%RTR-W-JOUALREXI, Journal already created

Explanation: A previously existing journal was found.

This status, returned by the CREATE JOURNAL command, indicates that you have issued an RTR CREATE JOURNAL command without deleting the previous journal.

To create a journal, do one of the following:

use the /SUPERSEDE qualifier with the CREATE JOURNAL command or delete the old journal with the DELETE JOURNAL command.

RTR Utility Messages

D.1 Utility Error Messages

%RTR-E-JOUCDROM, CD-ROM is unwritable, not suitable for a journal

Explanation: RTR cannot create a journal on a device that is a Compact Disc Read Only Memory and therefore mounted read-only and not designed to be writable.

%RTR-S-JOUDELETE, Journal has been deleted

Explanation: Journal has been successfully deleted after issuing a DELETE JOURNAL command.

%RTR-E-JOUDEVICEUNKNOWN, Cannot determine the device type, no journal has been created

Explanation: RTR cannot tell if the specified device is suitable for a journal. Setting the environment variable RTR_SCAN_ALL may help to overcome this if you are certain that the device is in fact suitable.

%RTR-E-JOUDISKFULL, Disk is full, cannot create journal

Explanation: The disk or file system is full, or the disk space quota is exceeded.

%RTR-F-JOUFILMIS, RTR journal file missing - Find missing file or use CREATE JOURNAL /SUPERSEDE

Explanation: One of the previously initialized RTR journal files for a backend could not be found. This status may be returned by the CREATE FACILITY and SHOW JOURNAL commands.

Probable causes are:

- (1) One of the disks being used for journalling is unavailable, or
- (2) A user has inadvertently deleted an RTR journal file.

Corrective action, either:

- (a) Bring the missing disk back on line, or
- (b) Reissue the RTR CREATE JOURNAL /SUPERSEDE command to create a new journal (in this case any recovery information in the old journal is lost).

%RTR-F-JOUFORCHA, Journal format has been changed - CREATE JOURNAL /SUPERSEDE

Explanation: The journal file(s) found have an out-of-date format. This status may be returned by the CREATE FACILITY and SHOW JOURNAL commands after a new version of RTR has been installed on a system.

Corrective action: Issue an RTR CREATE JOURNAL /SUPERSEDE command.

%RTR-W-JOUINUSE, Journal is locked by another user

Explanation: The journal is currently in use by another user.

This status may be returned by the CREATE JOURNAL, and DELETE JOURNAL commands.

Corrective action:

Wait for the other user to complete, then reissue the command.

%RTR-W-JOULOCKED, Journal locked - may interfere with standby recovery during dump

Explanation: The /LOCK qualifier locks the journal, making it unavailable to all RTR processes during the duration of dump execution. This may interfere with standby recovery if a standby node tries to open the journal.

%RTR-E-JOUNOTAVA, Error during recovery ([A]) from [A] journal

Explanation: The RTR transaction manager requested recovery from a remote journal, but the request could not be delivered to the node hosting the journal. In a non-clustered standby configuration, this indicates that local recovery after a server failure could not be completed. No user action is required, because the transaction manager will attempt to send the recovery query again, once it has detected that the remote journal has become available.

%RTR-F-JOUNOTFOU, Journal not found

Explanation: No RTR journal files can be found.

This status may be returned by the CREATE FACILITY, DELETE JOURNAL and SHOW JOURNAL commands.

This is due to one of the following:

- a) You have not issued an RTR CREATE JOURNAL command.
- b) All journal disks are offline.

RTR Utility Messages

D.1 Utility Error Messages

c) The journal files have already been deleted.

%RTR-F-JOUNOTINI, Journal has not been created - CREATE JOURNAL

Explanation: No RTR journal files can be found.

This status may be returned by the CREATE FACILITY and SHOW JOURNAL commands.

This can be due to one of the following:

a) You have not issued an RTR CREATE JOURNAL command.

b) All journal disks are offline.

c) The journal files have been inadvertently deleted.

Either:

1) Bring the journal disk on line

2) Issue an RTR CREATE JOURNAL command.

%RTR-E-JOURAMDISK, RAM disk, unreliable for a journal

Explanation: There is no point in RTR creating a journal on a volatile memory device whose contents are not persistent and will disappear on power failure or reboot.

%RTR-E-JOUREADONLY, Read-only device, not suitable for a journal

Explanation: RTR cannot create a journal on a device that is either mounted read-only or is not designed to be writable.

%RTR-E-JOUREMOTDEVIC, Unreachable remote device, not suitable for journal

Explanation: Remote devices should only be used for journals if they are in fact disks in the same cluster mounted on a virtual host representing the cluster.

%RTR-S-JOURNALINI, Journal has been created on device [A]

Explanation: Confirms that the RTR journal has been successfully created on device [A] after issuing a CREATE JOURNAL command.

%RTR-S-JOURNALMOD, Journal has been modified on device [A]

Explanation: Confirms that the RTR journal has successfully modified the size requirements on device [A] after issuing a MODIFY JOURNAL command.

RTR Utility Messages

D.1 Utility Error Messages

%RTR-E-JVMCLSFAIL, JVM failed to invoke [A] class

Explanation: The Java Virtual machine (JVM) failed to invoke the required class. Please check the CLASSPATH definition on your system.

%RTR-E-JVMFAIL, Unable to create a JVM in the RTRACP process

Explanation: Error occurred while creating a Java Virtual Machine in the RTRACP process.

%RTR-E-JVMMTDFAIL, JVM failed to invoke [A] method

Explanation: JVM failed to invoke the required class method. Please check the CLASSPATH definition on your system.

%RTR-E-KEYTYPEVAL, Key type value for [A] missing - try one of string, signed, unsigned

Explanation: The type clause of the key qualifier requires a value - try one of string, signed, unsigned.

%RTR-F-KNLEXECFAIL, Knl_exec() delivered pid of 0 (starting [A]) on node [A][A]

Explanation: Indicates that knl_exec() failed, when trying to start a command server.

%RTR-E-KRINUSE, Key range already in use - respecify the key

Explanation: A call to rtr_open_channel() to create a partition specified a key range that is already in use. Respecify the key range.

%RTR-E-KRINUSEINJNL, Journalled transactions preclude change of partition name

Explanation: Transactions exist in the journal that were processed while this key range was assigned a different name. This equates to an attempt to change the partition name, which is not allowed. Recover or delete these transactions first.

%RTR-I-LFILREOPE, Log_file[[A]] [A] reopened

Explanation: The log file [A] has been reopened.

%RTR-E-LINKDISABLED, Link disabled - connection rejected

Explanation: The link to this node has been disabled at the remote partner. It can be enabled with the command SET LINK/ENABLE at the remote node.

RTR Utility Messages

D.1 Utility Error Messages

%RTR-E-LINKISOLATED, Link Isolated - connection rejected

Explanation: The link from the remote node to the local node has been isolated. It can be enabled with the command SET LINK/NOAUTOISOLATE on the local node.

%RTR-I-LIVEAPPL, Process [A], PID [A] still attached to RTR

Explanation: Displays the name [A] and PID of the processes that are still attached to RTR.

%RTR-I-LNKDSC, Link to node [A] disconnected

Explanation: This message is issued once per disconnected network link during execution of an RTR DISCONNECT LINK command.

%RTR-E-LOADLIBFAIL, Unable to dynamically load the shared library

Explanation: The RTRACP could not load the shared library dynamically.

%RTR-E-LOADSYMFAIL, Unable to find the symbol in the shared library

Explanation: The RTRACP could not locate the symbol name in the dynamically-loaded library.

%RTR-E-LOCKFAIL, Cannot obtain lock for resource [A]

Explanation: Failed to obtain lock. Enable logging to obtain for more information about the error.

%RTR-E-LODDMPERR, An error occurred while loading the process dump.

Reason: [A][A]

Explanation: An error occurred that prevented the LOAD DUMP command from loading part or all of the specified dump file into memory. The reason for the failure is given.

In some cases, /FORCE can be used to force the command to continue despite the error. However, use of /FORCE is risky and may result in chaotic behavior.

%RTR-W-LODDMPINC, The process dump was not fully loaded. %u record(s) successfully read.

Explanation: An error occurred that prevented the LOAD DUMP command from loading all of the specified dump file into memory. Note that part of the load may have completed, and this part that was loaded may be analyzed without further intervention. However, not all of the dump file was loaded.

The number of memory records successfully read into memory is specified.

RTR Utility Messages

D.1 Utility Error Messages

%RTR-W-LODDMPMIS, %u links(s) were omitted because the linked record is not present

Explanation: This warning is reported by the LOAD DUMP command to indicate that at least one link was omitted because it is linked to a record not found in the dump. Specifically, one or more records were linked to other records, but the other records are not present in the dump file.

This may affect later attempts to analyze the file, as some links and records will not be present.

The number of omitted links is given.

%RTR-S-LOGFILSET, Logging to [A]

Explanation: Displays which log files will be used after issuing a SET LOG command with the /FILE, /OPERATOR or both qualifiers.

%RTR-S-LOGFILSUP, Logging suppressed

Explanation: Logging has been successfully suppressed by issuing a SET LOG command without a /FILE or /OPERATOR qualifier.

%RTR-E-LOGNOTACT, Logging not active

Explanation: Indicates that logging was not active when a SHOW LOG command was issued.

%RTR-F-MAXPARM, Too many parameters - reenter command with fewer parameters

Explanation: A command contained more than the maximum number of parameters allowed. This error can be caused by one of the following: (a) Leaving blanks on a command line where a special character (for example, a comma or plus sign) is required. (b) Using symbol names or logical names that, when substituted or translated, contain embedded blank characters. (c) Failing to place quotation marks around a character string that contains embedded blanks.

%RTR-E-MAXTOOSMA, Maximum number of blocks may not be less than /BLOCKS

Explanation: The number of blocks specified with the /MAX_BLOCKS qualifier in the CREATE JOURNAL or MODIFY JOURNAL command was lower than the number of blocks specified with the /BLOCKS qualifier.

RTR Utility Messages

D.1 Utility Error Messages

%RTR-F-MISSINGREQFLG, A required flag is missing.

Explanation: One of the required flags (Server, Client, Create_Partition, or Delete_Partition) is missing. Please enter the desired flag for your command.

%RTR-E-MLTPRTTX, Partition name required for multiparticipant txn

Explanation: This is a multiparticipant transaction. The user must supply the name of the partition whose transaction state the user wants to change.

%RTR-E-MONCMPERR, Syntax error in command at line [A] in file [A]

Explanation: Error found compiling a MONITOR definition file.

%RTR-E-MONNOTACT, Monitor is not active, first use the "MONITOR" command

Explanation: A SCROLL or PRINT command was issued before any monitor picture had been displayed.

%RTR-E-MSGDATILL, Unable to convert string [A] to [A]

Explanation: The string [A] could not be converted to the given data type. The subsequent message gives the reason.

%RTR-E-MSGTOOBIG, The number of bytes in message exceeds the maximum of %u

Explanation: The message structure is too long. Specify shorter messages.

%RTR-W-NAMERR, Node name to address lookup error

Explanation: Error encountered while looking up a node address - details follow in subsequent message text.

%RTR-E-NDBTABFUL, The NDB table is full

Explanation: This message is displayed when an CREATE FACILITY command is issued. It indicates that the total number of different nodes specified with this and all previous CREATE FACILITY commands would exceed the limit specified with the /LINKS qualifier when RTR was started.

%RTR-E-NFW, Operation requires "SETPRV" privilege

Explanation: SETPRV privilege is required to execute a remote command.

RTR Utility Messages

D.1 Utility Error Messages

%RTR-E-NOACTION, No object management action specified - check argument set_qualifiers

Explanation: No action was supplied along with an object management request. Check your program.

%RTR-I-NOAPPSRV, No application server channels currently declared

Explanation: Indicates that no application server channels are currently declared, and hence the requested information cannot be output.

%RTR-E-NOBACKEND, No backends specified

Explanation: No backends were specified on a CREATE FACILITY command and the node where the command was executed was specified as being a router.

%RTR-S-NOCHANGES, No changes made

Explanation: The modifications specified resulted in no changes being required.

%RTR-F-NOCHANOPEN, No channel is currently open

Explanation: No application channels are currently open so messages cannot be transmitted. Open a channel to send or receive messages.

%RTR-E-NODECNET, Network unavailable

Explanation: DECnet was shut down on the local node while the RTR utility was in use.

%RTR-F-NODEFDEV, No default device found for journal creation

Explanation: The CREATE JOURNAL command failed because RTR was unable to find a suitable default device for a journal.

%RTR-E-NODISOLATED, Node isolated - connection rejected

Explanation: Auto-isolation has isolated the node. Connection attempts from the isolated node are refused in this state. Connections can be enabled by issuing the following commands:

- on the isolating node(s): set link/enable isolated-node-name

- on the isolated node: set node/noisolate

This status supersedes the V2 condition LINKSHUT.

RTR Utility Messages

D.1 Utility Error Messages

%RTR-E-NODNA, DECnet specified for [A], but transport protocol unavailable or disabled

Explanation: DECnet was specified as required through use of a node name prefix ("dna." or a substitute), but no corresponding entry in the node database can be found. Add an entry for the indicated node to your local node name database or to your name server.

%RTR-W-NODNANAM, DECnet is installed, but no node name definition found for [A]

Explanation: DECnet is active and enabled on the local node, but the address lookup for the indicated node failed. Since other network transports are available, you may continue, but protocol failover to DECnet will not be possible following this condition.

If the message refers to a host named local, this indicates an inability to determine the DECnet name of the local host. This can happen if DECnet has been stopped, for example as part of a system shutdown, or you may have a DECnet configuration problem. It will not be possible to start RTR while this condition persists.

%RTR-E-NODNOTFND, Node [A] not found in configuration - check spelling and case

Explanation: Unable to locate the referenced node in the current configuration. Might occur if the address of the node was changed since it joined the configuration and the name was not entered exactly as displayed in show link output.

%RTR-E-NODNOTKNO, Node not known, [A]

Explanation: The node [A] is unknown to DECnet.

%RTR-E-NODTXOPENSTRING, No RM open_string specified

Explanation: No "open_string" values were specified on a CREATE RM command while trying to register an underlying RM (XA Resource Manager) with the ACP.

%RTR-E-NODTXRMLIB, No dtx rm lib pathname specified

Explanation: No "xalib path" values were specified on a CREATE RM command while trying to register an underlying RM (XA Resource Manager) with the ACP.

%RTR-E-NOFACOUNTERS, There are no facility-specific counters to display

Explanation: The /FACILITY qualifier was used with the MONITOR command, but there are no facility-specific counters to display.

RTR Utility Messages

D.1 Utility Error Messages

%RTR-E-NOFACILIT, No facilities have been defined

Explanation: No facilities have yet been defined with the CREATE FACILITY command.

%RTR-E-NOFRONTEN, No frontends specified

Explanation: No frontends were specified on a CREATE FACILITY command and the node where the command was executed was specified as being a router.

%RTR-I-NOHLPENV, No help available (environment variable RTRHELP not found)

Explanation: The environment variable RTRHELP that defines where the RTR help files are is not defined.

%RTR-W-NOIPNAM, IP networking is installed, but no host definition found for [A]

Explanation: IP networking is active and enabled on the local node, but the address lookup for the indicated node failed. Since other network transports are available, you may continue, but protocol failover to TCP will not be possible following this condition.

%RTR-E-NOKEYBOUND, A key segment low or high bound value is missing for [A]

Explanation: A key segment low- or high-bound value string is required.

%RTR-E-NOKEYSEGS, You must specify at least one key segment - use /KEY1 - /KEY9

Explanation: Except for a callout partition, it is necessary to define the key range, so the absence of any key segment descriptors is an error.

%RTR-F-NOKEYW, Qualifier name is missing - append the name to the slash

Explanation: A slash character is on the command line but is not followed by a qualifier keyword name.

%RTR-E-NOLENVAL, A value is required for clause [A] of [A]

Explanation: The specified clause requires a value - specify a digit string.

%RTR-E-NOLICENSE, No license installed

Explanation: Appropriate license is not installed for the required operation.

RTR Utility Messages

D.1 Utility Error Messages

%RTR-F-NOLIST, List of parameter values not allowed - check use of comma
(,)

Explanation: The command does not accept a parameter list.

%RTR-E-NOLNKCOUNTERS, There are no link-specific counters to display

Explanation: The /LINK qualifier was used with the MONITOR command, but there are no link-specific counters to display.

%RTR-I-NOLOGSET, Logging not set

Explanation: RTR was started with logging disabled.

It is recommended to use RTR SET LOG to enable logging before starting RTR. Various important messages are only written to the log file and will be lost forever if logging is not enabled.

As with any log file, the RTR log will grow with time. Log files should be located on a disk or filesystem where they will not interfere with operation. Should the log file become too big you can set a new log file, and archive, compress or delete the old one.

%RTR-F-NOMOREPRT, No more partition slots available

Explanation: RTR is unable to create an additional partition since the limit on the number of partitions on this backend has been reached. Use the /Partitions qualifier to the 'start rtr' command to specify a higher limit. The default value for this limit is 500 partitions. The maximum permitted value is 65536.

%RTR-F-NONPRINTBLE, Command line contains a non-printable character

Explanation: Command line contains a non-printable character.

%RTR-E-NOOUTSTND, No outstanding operations on channel [A]

Explanation: A SYS\$SYNCH command was issued but there were no outstanding operations on channel [A]

%RTR-F-NOPAREN, Value improperly delimited - supply parenthesis

Explanation: A value supplied as part of a parenthesized value list for a parameter, qualifier or keyword is missing a delimiting parenthesis.

%RTR-E-NOPARTCOUNTERS, There are no partition-specific counters to display

Explanation: The /PARTITION qualifier was used with the MONITOR command, but there are no partition-specific counters to display.

RTR Utility Messages

D.1 Utility Error Messages

%RTR-E-NOPRCCOUNTERS, There are no process-specific counters to display

Explanation: The /ID qualifier was used with the MONITOR command, but there are no process-specific counters to display.

%RTR-E-NORMXASWITCH, No dtx rm xa_switch name specified

Explanation: No "xaswitch" values were specified on a CREATE RM command while trying to register an underlying RM (XA Resource Manager) with the ACP.

%RTR-E-NOROUTERS, No routers specified

Explanation: No routers were specified on a CREATE FACILITY command and the node where the command was executed was specified as being a frontend or a backend or both.

%RTR-E-NORTRPROC, No processes using RTR

Explanation: No processes are currently using RTR.

%RTR-E-NOSRVAVL, Service not yet available

Explanation: Client channel open could not be completed because there is either no router available, or no server channel has yet been opened.

%RTR-E-NOSUCHCHN, No channel matched [A]

Explanation: The requested channel [A] has not been declared.

%RTR-E-NOSUCHCOU, No counter matched [A]

Explanation: The requested counter [A] does not exist.

%RTR-E-NOSUCHDIS, No such monitor file, [A]

Explanation: The requested monitor file [A] does not exist.

%RTR-E-NOSUCHFAC, No facility matched [A]

Explanation: The requested facility [A] does not exist. See CREATE FACILITY.

%RTR-E-NOSUCHITM, Nothing displayed at x = [A], y = [A]

Explanation: Invalid coordinates were specified on a CLEAR DISPLAY or SHOW DISPLAY command. No item is displayed at point x, y.

%RTR-E-NOSUCHNOD, No such node, [A]

Explanation: The requested node [A] does not exist.

RTR Utility Messages

D.1 Utility Error Messages

%RTR-E-NOSUCHPRC, No such process, process ID = [A] (0x[A])

Explanation: The process with PID = [A] does not exist or is not using RTR.

%RTR-E-NOSUCHPRCS, No such process, process ID = [A]

Explanation: The process with PID = [A] does not exist or is not using RTR. Like NOSUCHPRC, but used where the PID is only available as a string.

%RTR-E-NOSUCHPRT, No partition matched [A]

Explanation: The requested partition [A] does not exist.

%RTR-E-NOSUCHPRTN, No such partition in the system

Explanation: No such partition in the system. Also returned when when processing a SET PARTITION command through the `rtr_set_info()` API if the partition name has not been specified via the `selitms` argument.

%RTR-E-NOTCP, TCP specified for [A], but transport protocol unavailable or disabled

Explanation: TCP was specified as required through use of a hostname ("tcp." or a substitute), but no hostname entry can be found. Add an entry for the indicated node to your `/etc/hosts` file or to your name server.

%RTR-E-NOTHLIST, Nothing to LIST ...

Explanation: Nothing to list.

%RTR-E-NOTHTODIS, There is nothing to display

Explanation: No items had been defined with the DISPLAY command when a MONITOR or SCROLL command was issued.

%RTR-W-NOTNEG, Qualifier or keyword not negatable - remove "NO" or omit n [A]

Explanation: The word NO preceded a qualifier or keyword, but the qualifier or keyword cannot be specified as a negative.

%RTR-E-NOTNESTEDTX, TX in progress is not nested

Explanation: A call to `rtr_prepare_tx` was called on a channel with an active TX that is not a nested TX. To start a nested TX, you must start the TX by calling `rtr_start_tx` with a valid `jointxid` parameter.

RTR Utility Messages

D.1 Utility Error Messages

%RTR-E-NOTSAMTYP, All counters must have same type, [A]

Explanation: Counter [A] is not the same type as the other counters in the expression. All counters in an expression must be either "process counters," "facility counters," "link counters" or "node counters."

%RTR-I-NOTSTACOMSRV, Could not start command server on node [A][A]

Explanation: Indicates that a command server could not be started on the specified node [A].

%RTR-F-NOVALU, Value not allowed - remove value specification

Explanation: A value has been specified for a qualifier that does not take a value. Remove the value specification.

%RTR-W-NTREAGENTREQ, Missing Windows Registry Entry: [A]

Explanation: Missing Windows Registry Entry.

%RTR-E-NUMCONILL, Numeric constant has illegal syntax, [A]

Explanation: The numeric constant [A] is invalid.

%RTR-W-OBSQUAL, Qualifier [A] is obsolete - value ignored

Explanation: An obsolete qualifier has been specified on a command line. The qualifier no longer has any effect, and the specified value will be ignored.

%RTR-E-OFFSETNOTREQD, OFFSET should not be used, if Partition is associated with JSTREAM

Explanation: The offset value of the Key of a partition is not required if the partition is associated with JSTREAM transaction.

%RTR-S-OK, Normal successful completion

Explanation: The command or action completed successfully. Nothing went wrong.

%RTR-E-ONLONENOD, Only one node allowed if process ID specified

Explanation: If a process ID is supplied on MONITOR command then only one node may be monitored.

RTR Utility Messages

D.1 Utility Error Messages

%RTR-E-ONLYDISP, Only "DISPLAY" command allowed in this context
n[A]

Explanation: The specified display file contained a command [A] other than DISPLAY. This is sometimes caused by forgetting the continuation character (-) on the end of a line that is to be continued. Use MONITOR/VERIFY to find the incorrect command.

%RTR-W-OPENVMSQUAL, Qualifier [A] is not supported on this platform -
value ignored

Explanation: A qualifier has been specified on a command line that is effective only on the OpenVMS operating system. The qualifier has no effect on the executing platform, and the specified value will be ignored.

%RTR-I-OPTSUPSED, The RTR V2.x option [A] is obsolete.

Explanation: The option is obsolete in this version of RTR.

%RTR-E-OWNNODMIS, Executing node [A] not specified as frontend,
backend or router

Explanation: The node [A] where a CREATE FACILITY or EXTEND FACILITY command was executed was not specified as being a frontend, router or backend.

%RTR-F-PARMDEL, Invalid parameter delimiter - check use of special
characters
n [A]

Explanation: A command contains an invalid character following the specification of a parameter, or an invalid character is present in a file specification.

%RTR-F-PARREQ, Missing parameter - supply required parameter
n [A]

Explanation: Missing parameter.

%RTR-E-PARTNAMELONG, Partition name too long

Explanation: Long partition name argument.

%RTR-E-PRCDMPERR, An error occurred while dumping the process.

Reason: [A][A]

Explanation: An error occurred that prevented the DUMP PROCESS command from dumping all or part of the process into a raw dump file. The reason for the failure is given. This command is invoked automatically in certain conditions, including a process crash.

If successful, the raw dump file may later be analyzed by the appropriate personnel.

%RTR-E-PROCIDILL, Illegal process ID, [A]

Explanation: The specified process ID [A] has an invalid format. Process IDs are hexadecimal numbers with up to eight digits.

%RTR-S-PROPLISDEL, [A] property of ConnectionPool has been deleted

Explanation: The property list from ConnectionPool has been successfully deleted after issuing a DELETE CONNECTIONPOOL/PROPERTY_STRING command.

%RTR-I-PROPNOTFOU, The property [A] is not defined in the ConnectionPool

Explanation: The property is not defined in the ConnectionPool.

%RTR-E-PRTALREXI, Partition already exists

Explanation: An attempt was made to create a partition that already exists.

%RTR-E-PRTBADCMD, Partition command invalid or not implemented in this version of RTR

Explanation: The RTRACP received a request for an unknown partition command.

%RTR-E-PRTBADFPOL, Unrecognised partition failover policy code

Explanation: An invalid value was specified for the partition failover policy.

%RTR-E-PRTCMDACTV, Partition command is active - try again later

Explanation: An attempt was made to issue a partition command whilst a prior command instance is making a change to the system. Await prior command completion and try again.

RTR Utility Messages

D.1 Utility Error Messages

%RTR-I-PRTCREATE, Partition created

Explanation: The partition was successfully created by the call to `rtr_open_channel()`.

%RTR-E-PRTDEFNCONFLICT, Name and key information refer to different partitions

Explanation: A call to `rtr_open_channel()` specified both the partition name and key information, but these refer to different partitions.

%RTR-E-PRTDELCAN, Partition deleted - operation cancelled

Explanation: A pending operation was terminated because the partition was deleted before completion of the operation.

%RTR-E-PRTMODRMBR, Partition must be in remember on the active member

Explanation: Restriction: partition must be in remember mode on the active member before shadowing can be turned off.

%RTR-E-PRTMODSUSP, Partition not suspended - please suspend and retry the operation

Explanation: Completion status indicating a partition command was rejected as the partition was not in the prerequisite state. Suspend the partition first.

%RTR-E-PRTNACTIVE, Partition cannot be deleted so long as it has active servers or transactions

Explanation: Partition cannot be deleted so long as it has active servers or transactions.

%RTR-E-PRTNAMINUSE, Partition name already in use - use another name

Explanation: A call to `rtr_open_channel()` specified a partition name that is already in use in another partition of the facility. Use another name.

%RTR-E-PRTNAMINUSEINJNL, Journalled transactions preclude change of partition key range

Explanation: Transactions exist in the journal that were processed whilst this name was assigned to a different key range. Recover or delete these transactions first.

%RTR-E-PRTNAMNOTFND, The named partition does not exist

Explanation: A call to `rtr_open_channel()` specified a partition name that does not exist

RTR Utility Messages

D.1 Utility Error Messages

%RTR-S-PRTNCREATED, Partition created

Explanation: The requested partition was successfully created.

%RTR-S-PRTNDELETED, Partition deleted

Explanation: The requested partition was successfully deleted.

%RTR-S-PRTNEWFPOLS, Failover policy set

Explanation: The partition failover policy was successfully changed.

%RTR-S-PRTNEWPOLWAIT, Failover policy stored - awaiting servers before taking effect

Explanation: The partition failover policy was successfully changed, but the change will only take effect once servers have been started.

%RTR-S-PRTNEWPRIO, Backend priority set

Explanation: The backend priority was successfully changed,

%RTR-S-PRTNEWPRIWAIT, Backend priority stored - awaiting servers before taking effect

Explanation: Status indicating successful change to the backend priority, but the change will only take effect once servers have been started.

%RTR-E-PRTNODNOTDEF, No definition found for a node in the list - see log file

Explanation: Status indicating absence of a definition for a node named in list of back ends for the partition.

%RTR-E-PRTNODNOTLST, Local node must be in the list of back end nodes

Explanation: Status indicating erroneous absence of the local node from the ordered list of back ends for the partition.

%RTR-E-PRTNOSRVRS, Partition has no servers - please start servers and retry

Explanation: Cannot perform the requested action until servers are attached to the partition. Start servers and retry.

%RTR-E-PRTNOTBACKEND, Partition commands must be entered on a backend node

Explanation: Restriction: partition commands must be entered on a BACKEND node.

RTR Utility Messages

D.1 Utility Error Messages

%RTR-E-PRTNOTR, Partition command cancelled - no routers available

Explanation: The partition command cannot complete due to the lack of connected routers. Fix the connectivity problem and try again.

%RTR-E-PRTNOTSUSP, Unable to resume partition that is not suspended

Explanation: A partition resume command was attempted when the target partition was not suspended.

%RTR-E-PRTRECSTATE, Partition must be in remember or active (non-recovery) state

Explanation: An attempt was made to restart recovery whilst not in remember or active (for standby servers) mode.

%RTR-S-PRTRRESUME, Partition resumed

Explanation: The partition resume command completed successfully. Transaction presentation is now enabled.

%RTR-S-PRTRSRTCVMY, Partition recovery initiated

Explanation: Completion status indicating that partition recovery was manually initiated by the operator.

%RTR-E-PRTRUNDOWN, Partition is in rundown prior to deletion - no action taken

Explanation: Cannot perform the requested action since the partition is being deleted.

%RTR-W-PRTRSCOPE, Partition has no servers - scope of command is restricted to the executing node

Explanation: The partition has no servers, so the scope of command is restricted to the executing node.

%RTR-I-PRTRSHDOFF, Partition [A]:[A] shadow state set to off by operator [A]

Explanation: The partition shadow state was changed in response to the user request.

%RTR-I-PRTRSHDON, Partition [A]:[A] shadow state set to on by operator [A]

Explanation: The partition shadow state was changed in response to the user request.

RTR Utility Messages

D.1 Utility Error Messages

%RTR-I-PRTSUSCAN, Suspend operation cancelled - partition resumed by operator

Explanation: A pending partition suspend operation has been cancelled as a result of the operator command to resume the partition.

%RTR-S-PRTSUSPENDED, Partition suspended - use resume to restart transaction presentation

Explanation: The partition suspend command completed successfully. Transaction presentation is now halted. Use resume to restart.

%RTR-E-PRTSUSTMO, Suspend operation timeout - transaction presentation is reset to active

Explanation: A time out condition was encountered while waiting for the partition to be suspended. The partition transaction presentation is reset to "active."

%RTR-E-PTRARDYSUSP, Partition already suspended

Explanation: A partition suspend command was attempted when the target partition was already suspended.

%RTR-E-PTRSUSPENDING, Partition already suspending - awaiting completion of current transactions

Explanation: A partition suspend command was attempted while the target partition was already suspending. Be more patient.

%RTR-E-RCHALRSTA, RTR remote client handler already started

Explanation: The remote client handler was already running when the START_REMOTE_CLIENT_HANDLER command was executed.

%RTR-E-RCHNOTSTA, RTR remote client handler not started

Explanation: The remote client handler had not been started when a command was issued which requires it to be running.

%RTR-E-RCHWASSTO, RTR remote client handler has been stopped

Explanation: The remote client handler had been stopped when a command was issued which requires it to be running.

%RTR-S-REASONSTS, Reason status: [A]

Explanation: Displays the contents [A] of the RSNSTS field of the TXSB after calling a RTR V2 system service via the DCL interface.

RTR Utility Messages

D.1 Utility Error Messages

%RTR-E-RESERVFILE, Reserved device name is used as file, [A]

Explanation: A file name begins with a reserved device name (CONx, LPTx, COMx, PRN, etc.). Because the device names are reserved for use in Windows environments, their use is not allowed in RTR.

%RTR-E-RMSTRINGLONG, Resource manager open or close string too long

Explanation: Resource manager open or close string too long.

%RTR-E-RTRALRSTA, RTR already started

Explanation: RTR was already running when the START RTR command was executed.

%RTR-S-RTRLOGENT, [A]

Explanation: The RTR LOG command was used to make an entry in the RTR LOG.

%RTR-I-RTRNOTRUN, RTR not running

Explanation: Message created specifically for the STOP RTR command if RTR is not currently running, so that the IVP does not report a fatal message.

%RTR-E-RTRNOTSTA, RTR not running

Explanation: RTR had not been started when a command was issued which requires RTR to be running.

%RTR-S-RTRRCHSTART, RTR remote client handler started

Explanation: Indicates that remote client handler has been successfully started after issuing a START REMOTE_CLIENT_HANDLER command.

%RTR-S-RTRRCHSTOP, RTR remote client handler stopped

Explanation: Indicates that the remote client handler has been successfully stopped after issuing a STOP REMOTE_CLIENT_HANDLER command.

%RTR-S-RTRSTART, RTR started on node [A][A]

Explanation: RTR has been successfully started after issuing a START RTR command.

%RTR-S-RTRSTOP, RTR stopped on node [A][A]

Explanation: RTR has been successfully stopped after issuing a STOP RTR command.

%RTR-E-RTRWASSTO, RTR has been stopped

Explanation: RTR had been stopped when a command was issued which requires RTR to be running.

%RTR-E-SECGRP, User authentication can only be disabled for system mode operation

Explanation: You cannot disable user authentication in the current operational mode.

%RTR-S-SETTRANDONE, [A] transaction(s) updated in partition [A] of facility [A]

Explanation: The requested set transaction command was successfully performed.

%RTR-W-SETTRANROUTER, Cannot process this command if coordinating router still available

Explanation: The SET TRANSACTION command cannot change because router is still available.

%RTR-S-SPCREATED, ServiceProvider [A] created

Explanation: Displays the name [A] of the ServiceProvider that was successfully created after issuing a CREATE SERVICEPROVIDER command.

%RTR-S-SPDELETED, ServiceProvider [A] deleted

Explanation: Confirms that the RTR ServiceProvider was deleted after issuing a DELETE SERVICEPROVIDER command.

%RTR-E-SPDELFILEFAIL, Unable to delete ServiceProvider's information

Explanation: The JVM cannot delete the ServiceProvider's information. This status may be returned by a DELETE CONNECTIONPOOL/DATASOURCE command.

%RTR-E-SPEMPTYLIS, ServiceProvider [A] is missing a value

Explanation: The ServiceProvider must have a value in its Key element.

%RTR-E-SPFILERDFAIL, Unable to read ServiceProvider's information

Explanation: The JVM cannot read the ServiceProvider's information. This status may be returned by a MODIFY CONNECTIONPOOL /DATASOURCE or CREATE CONNECTIONPOOL /DATASOURCE command.

RTR Utility Messages

D.1 Utility Error Messages

%RTR-E-SPFILEWRFAIL, Unable to write ServiceProvider's information

Explanation: The JVM cannot write the ServiceProvider's information.

This status may be returned by a MODIFY SERVICEPROVIDER or CREATE SERVICEPROVIDER command.

%RTR-E-SPINUSE, ServiceProvider [A] is currently in use

Explanation: The ServiceProvider name specified in a CREATE CONNECTIONPOOL or CREATE DATASOURCE command is already associated with another ConnectionPool or DataSource.

%RTR-S-SPMODIFIED, ServiceProvider [A] has been modified

Explanation: Confirms that the MODIFY SERVICEPROVIDER command has successfully modified the required parameter of the RTR ServiceProvider.

%RTR-E-SPNOTFOU, ServiceProvider [A] not found

Explanation: The RTR ServiceProvider was not found.

This status may be returned by a MODIFY SERVICEPROVIDER, DELETE SERVICEPROVIDER, and SHOW SERVICEPROVIDER command.

Either:

- 1) You have not issued an RTR CREATE SERVICEPROVIDER command or
- 2) The ServiceProvider has been deleted.

%RTR-E-SPPROPFMAT, The format of a ServiceProvider [A] property is invalid - use key:val format

Explanation: The format of a ServiceProvider property is not proper. The defined format is "/property=(key1:val1, key2:val2,...)".

This status may be returned by a MODIFY SERVICEPROVIDER or CREATE SERVICEPROVIDER command.

%RTR-E-SPPROPNOTFND, [A] is not a supported key

Explanation: The key entered is not supported in the current environment.

This status may be returned by a MODIFY SERVICEPROVIDER or CREATE SERVICEPROVIDER command.

%RTR-I-SPPROPNOTFOU, Property [A] is not defined in the ServiceProvider

Explanation: The property is not defined in the ServiceProvider.

RTR Utility Messages

D.1 Utility Error Messages

%RTR-S-SPTESTED, ServiceProvider [A] tested successfully

Explanation: The ServiceProvider was successfully tested after issuing a CREATE SERVICEPROVIDER/TEST command.

%RTR-I-SPTESTFAIL, ServiceProvider [A] test failed

Explanation: The testing of the ServiceProvider failed after issuing a CREATE SERVICEPROVIDER/TEST command.

%RTR-F-SPUJOUFIL, Spurious RTR journal file found - remove extra file or use CREATE JOURNAL /SUPERSEDE and submit a Problem Report

Explanation: A spurious RTR journal file has been found which does not correspond to the other journal files on the system. This status may be returned by the CREATE FACILITY and SHOW JOURNAL commands.

Probable cause:

System management error. A user has copied a journal file, or a disk containing a journal file. RTR can now see extra journal files, or copies, that do not belong in the set.

Corrective action, either:

(a) Check the log for the relevant filenames, and delete or move the spurious journal file or files, or

(b) Reissue the CREATE JOURNAL /SUPERSEDE command (in this case any recovery information in the old journal is lost).

%RTR-I-STACOMSRV, Starting command server on node [A][A]

Explanation: An RTR command server process is being started on node [A]. The command server times out after not being used for a while, and is restarted automatically when needed.

%RTR-E-SUPCHAEND, Superfluous characters at end of expression, [A]

Explanation: The expression is invalid because the characters [A] at the end of the expression could not be interpreted.

%RTR-I-SYSSRVCOM, [A] completed on channel [A]

Explanation: Displays the name [A] of the operation that completed on a channel after issuing a SYS\$SYNCH command.

%RTR-I-SYSSRVNOW, [A] posted with no wait on channel [A]

Explanation: Displays the name [A] of the operation that was issued with the /NOWAIT qualifier on the named channel.

RTR Utility Messages

D.1 Utility Error Messages

`%RTR-E-TEMPLATE_NOT_FE`, Template link [A] valid for frontends only

Explanation: Template link names are valid for frontend roles only. It is an error to attempt to associate a template link name with the router or back end roles. A template link is link whose name contains one or more wild characters chosen from the set `"*?%"`. `"*"` indicates a sequence of wild characters; `"?"` and `"%"` indicate an occurrence of a single wild character.

`%RTR-E-TIMOUT`, Call to `rtr_receive_message` timed out

Explanation: `rtr_receive_message` was called, but `"timeoutms"` milliseconds have elapsed and no message was received on the channel(s) specified. The timeout has expired and the transaction aborted.

`%RTR-F-TIOSYS_FAILURE`, General failure in TIO

Explanation: General failure in terminal I/O.

`%RTR-F-TIO_BADROWCOL`, The terminal is defined as : rows = [A] and cols = [A]

Explanation: Cannot use the terminal; rows or columns is set to 0. For UNIX platforms, please use `"stty -a"` to check rows and columns. Then use a command like `"stty rows 50 cols 132"` to set them correctly.

`%RTR-E-TOOBIG`, [A] may not be greater than [A]

Explanation: The value of qualifier [A] must be less than or equal to [B].

`%RTR-F-TOOMANCHA`, Too many channels already opened

Explanation: Too many channels already opened. Recent versions of RTR support 255 channels per RTR application process.

`%RTR-E-TOOMANCHN`, Too many channels

Explanation: Displayed when a `SYS$DCL_TX_PRC` command is issued and the channel table is full.

`%RTR-F-TOOMANDIS`, Too many disks specified in journal definition

Explanation: Too many disks were specified in journal definition. The RTR journal can be defined to use up to a maximum of sixteen disks.

User Action: Issue the `CREATE JOURNAL` command specifying a smaller number of disks.

`%RTR-F-TOOMANREC`, Too many records for one entry in the journal

Explanation: An attempt was made to write more than 65534 records to one entry (transaction) in the journal.

RTR Utility Messages

D.1 Utility Error Messages

%RTR-E-TOOMANYOBJ, Max DECnet objects exceeded, raise and retry command

Explanation: The executor limit on the number of DECnet connect objects has been exceeded. Please use NCP to raise the maximum number of objects on this node.

%RTR-E-TOOMUCDAT, Too much data to be monitored

Explanation: An attempt was made to monitor too many processes. Please submit a Problem Report.

%RTR-E-TOOSMALL, [A] may not be less than [A]

Explanation: The value of qualifier [A] must be greater than or equal to [B].

%RTR-E-TRAALRSTA, Transaction already started, cannot be nested

Explanation: Transaction already started, cannot start another.

%RTR-I-TRMCENTRYNFND, No termcap-entry for terminal-type : [A]

Explanation: No such entry was found in the termcap file for the terminal type. For UNIX platforms, please check that the environment variables TERM and/or TERMCAP (if used) are correct. Also check that the TERMCAP file (if used) has a valid entry for your terminal type. (NOTE: These entries are case-sensitive.) The default terminal type is vt100.

%RTR-E-TRNOTALL032, Not all routers are at the minimum required version of V3.2

Explanation: Cannot perform the requested action since not all routers are at a minimum version of V3.2

%RTR-F-TRUNCATED, Buffer too short for msg

Explanation: Buffer too short for message, message truncated.

%RTR-I-TXINEXCEP, Transaction Aborted by Set Transaction to Exception

Explanation: This transaction is aborted by the server while set transaction command is used to change the state from commit to exception.

%RTR-F-TXNOTACT, No transaction currently active on this channel

Explanation: No transaction is currently active on this channel.

%RTR-E-TXNOTFOUND, Specified transaction not found

Explanation: RTR could not find the specified transaction(s).

RTR Utility Messages

D.1 Utility Error Messages

%RTR-E-UICNOTGRP, UIC [A] cannot be used in GROUP mode

Explanation: A SET MODE/GROUP command was issued while running under system UIC (group one). System UICs cannot be used in group mode.

%RTR-E-UNEXPEND, Expression ended before [A] encountered

Explanation: The expression is invalid because it terminated where when token [A] was expected.

%RTR-E-UNKNOWQUAL, Invalid qualifier keyword value - check your program

Explanation: An unrecognised qualifier keyword value was supplied. Check your program, and refer to the RTR C Application Programmer's Reference Manual for permissible values.

%RTR-F-UNRROUNAM, Unrecognised API routine name for CALL

Explanation: The parameter for the CALL command is the name (or part of a name) of an RTR API routine. This allows the user to type, for example, rtr call accept instead of rtr call rtr_accept_tx. This message is issued if the user has specified a part of an API routine name that does not match the name of an RTR API routine.

%RTR-F-VALREQ, Missing qualifier or keyword value - supply all required values

Explanation: A value must be specified for the keyword or qualifier.

%RTR-F-VALTOOBIG, 0x[A] is too big for [A] byte number

Explanation: A value has been specified that cannot be stored in the number of bytes specified. Specify a smaller value or a larger number of bytes.

%RTR-E-VERMISMAT, RTR version mismatch

Explanation: Utilities and/or shareable images being used are intended for a version of RTR different to that which is currently running on the system.

This message can however be ignored when it is displayed after issuing the first STOP RTR command after having just installed a new RTR release.

%RTR-I-WFPROCESS, Waiting for [A] to start up

Explanation: Displays the name [A] of the operation that completed on a channel after issuing a SYS\$SYNCH command.

RTR Utility Messages

D.1 Utility Error Messages

%RTR-E-WILNOTALL, Wild cards not allowed

Explanation: Wildcards (%) and (*) are not allowed.

%RTR-E-WINONLY, The specified operation is applicable only to Windows family hosts

Explanation: Command applicable to Windows hosts only.

%RTR-E-WTTR, Not in contact with sufficient router nodes - please retry later

Explanation: Returned by a set partition command when either inqurate or no routers available to process the command. Try again later when none of the above conditions exist.

%RTR-E-WTTROKERR, Unable to change the partition state from WT_TR_OK - server channel closed automatically

Explanation: A partition instance created is not able to come out of WT_TR_OK state. Since further processing is not possible, the server channels associated with the affected partition have been automatically closed.

An application may optionally open one or more channels to create a new instance of the partition.

RTR Log Messages

E.1 Operator Log Messages

This appendix describes the various error messages that can be sent to the operator console or written to RTR's operator log file.

The following table gives the meaning of the various error codes.

Code	Meaning	Description
S	Success	The system has successfully performed your request. In some cases, the command processing continues after the message is issued.
I	Information	The system has performed your request. The message provides information about the process.
W	Warning	The command may have performed some, but not all, of your request. The message may suggest that you verify the command or the program output.
E	Error	The output or program result is incorrect, but the system may attempt to continue execution.
F	Fatal (Severe)	The system cannot continue to execute the request.

`%RTR-E-ABODEAREQ`, Transaction aborted that was started by client that has since exited

Explanation: A transaction started by a client that has since exited has been aborted.

`%RTR-E-ABODEASRV`, Transaction aborted that was accepted by a server that has since exited

Explanation: A transaction sent to a server that has exited has been aborted.

RTR Log Messages

E.1 Operator Log Messages

%RTR-E-ACCERR, Rejecting connect attempt from unconfigured node [A]

Explanation: Node [A] that has not been configured as part of any RTR facility is trying to establish a connection. This could be a configuration problem or a problem with setup of DNS service.

%RTR-W-ACCTIMOUT, Connection accept timer expired - link is closed

Explanation: An accept timeout has been introduced. If a connection dialogue does not complete within a reasonable amount of time, then that connection/link is closed.

%RTR-F-ACPINSRES, The RTRACP has insufficient resources

Explanation: The RTRACP was unable to perform an operation due to an unusual condition. This is most probably a resource issue, for example when the ACP cannot create an additional shared memory segment due to quota or system configuration limits. This may also occur on some platforms when an application connects to a newly restarted ACP before all applications have finished using the process counter shared memory segments belonging to a previous ACP.

The RTR log file usually contains more details.

%RTR-E-ACPLOWMEMORY, Free memory available to the RTRACP has fallen to [A] MB (total [A] MB allocated). New and uncommitted transactions are subject to rejection

Explanation: The available memory for the RTRACP is low. Until it has access to sufficient memory, the RTRACP will be unable to allocate additional memory for new and uncommitted transactions. Any new and uncommitted transactions are subject to being rejected. Additionally, any broadcasts sent to this node will be dropped and not delivered to any applications.

[A] specifies how many megabytes the RTRACP may allocate before it completely runs out of memory. [B] specifies how many megabytes the RTRACP has currently allocated.

If possible, increase the quotas for the RTRACP process, increase available memory, or both. See `START RTR/RESERVE_MEMORY_SIZE`.

%RTR-I-ACPSUFMEMORY, Transactions and broadcasts being processed according to RTR's original policies

Explanation: The RTRACP has access to sufficient memory. Transactions and broadcasts are now being processed according to RTR's original policies. See `START RTR/RESERVE_MEMORY_SIZE`.

RTR Log Messages

E.1 Operator Log Messages

%RTR-E-ALRDCNCTD, Remote node already connected

Explanation: This can be a reason for rejecting a connect request. Submit a problem report.

%RTR-E-ALRINPRGS, Connection already in progress

Explanation: This can happen if both ACPs simultaneously try to connect to each other.

%RTR-E-BADENVVARIABLE, Environment variable [A] has bad value [A]

Explanation: An environment variable has been defined with an invalid value. Use a valid value.

%RTR-E-BADIDSIZ, Bad node ID size [A] detected at 0x[A]

Explanation: Errors have been detected when processing an internal node identifier. The presence of this message indicates a serious problem in the configuration of the network name/address databases, and RTR will likely be unable to operate correctly. Quorum and fault tolerance will be adversely affected. Check all network databases for consistency of node and host names and addresses.

%RTR-E-BADIDTYP, Empty node ID encountered at 0x[A]

Explanation: Errors were detected during processing of an internal node identifier. The presence of this message indicates a serious problem in the configuration of the network name/address databases, and RTR will likely be unable to operate correctly. Quorum and fault tolerance will be adversely affected. Check all network databases for consistency of node and host names and addresses.

%RTR-E-BADNETMSG, Bad message received from [A] - check network hardware - Indications %u %u %u %u %u %u %u

Explanation: RTR was unable to interpret the content of a network message received from a remote RTRACP process. Message corruption is the most likely culprit. If the condition persists, consider a network health check. The indication numbers at the end of the message are for the use of RTR support engineers.

%RTR-I-BEINQUO, Backend is quorate in facility [A]

Explanation: The backend role now has quorum in the facility [A]

%RTR-W-BENOQUO, Backend has no quorum in facility [A]

Explanation: The backend role has lost quorum for facility [A]

RTR Log Messages

E.1 Operator Log Messages

%RTR-E-BEREPLAYQDELETED, Replay queue for backend deleted

Explanation: A transaction in progress on a backend has had its (replay) queue of replies to the client deleted. Please submit a problem report.

%RTR-E-BMHDRVSN, Unrecognised broadcast from [A] for facility [A] - check network - Indications %u %u %u [A]

Explanation: A node has received an unrecognised broadcast event from the indicated node. If the sending and receiving nodes are running compatible versions of RTR, the cause of this might be message corruption. If the condition persists, consider performing a network health check.

%RTR-F-BRODISBLO, Broadcast message(s) discarded because of network blockage

Explanation: One or more broadcast messages was discarded because network throughput was too slow. Reduce broadcast rate or increase communications link capacity. See the System Manager's Manual for information on adjusting WAITQ size.

%RTR-F-BRODISCAC, Broadcast message(s) discarded because of memory cache congestion

Explanation: One or more broadcast messages were discarded because local memory was exhausted. Reduce the rate at which broadcasts are sent, or increase the efficiency of broadcast processing by the recipient applications.

If you are sending many large broadcast messages and encountering this error, please submit a problem report for information on how to adjust the relevant parameters.

%RTR-F-BRODISLIN, Broadcast message(s) discarded because of link unavailability

Explanation: One or more broadcast messages was discarded because there is no logical link to the destination node.

%RTR-F-BUGCHECK, RTR fatal internal error

Explanation: Signaled by a process when an RTR internal error occurs. Please submit a problem report.

%RTR-I-CLUENABLED, RTR cluster [A] is enabled using [A]

Explanation: Indicates that RTR is using specific cluster software.

RTR Log Messages

E.1 Operator Log Messages

%RTR-S-CNCTACCFR, Connection request from [A] accepted

Explanation: A connection request from the RTRACP running on node [A] has been accepted.

%RTR-S-CNCTCFRM, Connection confirmed by [A]

Explanation: A connection request has been confirmed by the RTRACP running on node [A].

%RTR-I-CNCTLOST, Connection to [A] lost

Explanation: A network connection with node [A] was lost.

%RTR-W-CNCTREJBY, Connection request rejected by [A]

Explanation: The RTRACP on node [A] rejected a connect request from this node.

%RTR-W-CNCTREJFR, Connection request from [A] rejected

Explanation: The RTRACP on node [A] made a connect request that was rejected.

%RTR-E-COMDEAREQ, Transaction committed that was started by client that has since exited

Explanation: A transaction that was started by a client that has since exited has been committed.

%RTR-E-COMDEASRV, Transaction committed that was accepted by a server that has since exited

Explanation: A transaction that was sent to a server that has exited has been committed.

%RTR-I-COMJOUSEA, Commencing journal search of node [A] for transactions on facility [A] needing recovery

Explanation: Journal search is starting. This message appears when the first facility that has transactions needing recovery is created with a backend role.

%RTR-E-COMSRVFAIL, Command server failed - diagnostics written to [A]

Explanation: An instance of the RTR command server process has failed. Submit a problem report with supporting information on the current commands.

RTR Log Messages

E.1 Operator Log Messages

%RTR-I-CONNALIAS, Link [A] connected as [A]

Explanation: Support for internet tunnels allows for the configuration of links from which connections appear to originate with an source address other than that by which the local node is registered locally. For example, a connection may appear to originate from an pseudo-adapter address assigned by the tunnel server. The CONNALIAS message registers the acceptance of such a connection, and lists the names of the local and connecting IP addresses.

%RTR-E-CREDREJ, HTTP client credentials rejected: originating node [A], username [A]

Explanation: The HTTP-enabled command server found that the credentials presented by an HTTP client could not be validated by the host operating system. This error is innocuous if it follows a password change by the respective user in the host environment, and will disappear as soon as the server refreshes its password cache. Otherwise, this entry may signal a security problem. Frequent occurrence of this error will cause the client node to be disabled for a period of time to evade a possible password-probing attack.

%RTR-S-CURRTR, Node [A] now a router for facility [A]

Explanation: A new current router [A] has been found for the named facility

%RTR-E-CURRTRLOSS, Current router lost for facility [A]

Explanation: The router handling facility [A] for this frontend node has failed or [A] has been deleted on the router. No user intervention is expected, and an attempt is made to reconnect to an alternate router, if one is available.

%RTR-I-DTXRECOV, Commencing DTX journal search for transactions needing recovery,

log_id = %08X-%04X-%04X-%02X%02X-%02X%02X%02X%02X%02X%02X

Explanation: DTX journal search is starting. This message appears when RTR is started.

%RTR-I-DTXRECOVDONE, DTX journal search completed, [A] transactions found

Explanation: DTX journal search has completed. This message appears when RTR is started.

RTR Log Messages

E.1 Operator Log Messages

%RTR-E-DTXRECOVERFAIL, Obtaining a list of prepared transactions from an RM has failed

Explanation: A transaction manager (TM) calling xa_recover to obtain a list of prepared transaction branches failed while registering an XA resource manager (RM).

%RTR-I-DUMPOBJECT, [A]:
n[A]

Explanation: An object was dumped to the log.

%RTR-E-ENQDEAREQ, Server rtr_reply_to_client to a client that has since exited

Explanation: A call to rtr_reply_to_client was made for a client that has since exited.

%RTR-I-EVENTAST, Event AST for event number [A] on channel [A], data
'%.*s'

Explanation: An event was received on a channel defined by the RTR CLI using the V2 interface (\$dcl_tx_pr).

%RTR-E-EVNODE, HTTP client authorization error count exceeded for node [A] - taking evasive action for [A] seconds

Explanation: If client authentication errors from a particular node exceed the rate defined by the window and the error count, the server will take evasive action and refuse to accept subsequent connections from the client node concerned.

%RTR-W-EXCHANNELCNT, SYSGEN parameter CHANNELCNT too small for the requested number of processes and links

Explanation: The value of the OpenVMS SYSGEN parameter CHANNELCNT is too small to allow RTR to handle the requested number of application processes and links. RTR will start, but fewer application processes can be handled than specified. Review the values of the /PROCESS and /LINK qualifiers to the START RTR command. CHANNELCNT should be greater than 30 plus the number of links plus twice the number of processes specified.

%RTR-I-EXERTRCOM, Command: [A]

Explanation: A significant RTR command such as START RTR or CREATE FACILITY was issued.

RTR Log Messages

E.1 Operator Log Messages

%RTR-W-EXFREEPAGE, Requested page file quota exceeds free space in page files

Explanation: The page file quota specified on OpenVMS for the RTRACP process exceeds the current free space in the page file. RTR will start, but may have access to fewer resources than desired. Review the sizing qualifiers to the START RTR command (including the defaults) - you may need to increase the size of the system page file(s).

%RTR-W-EXMAXPROCESSCNT, SYSGEN parameter MAXPROCESSCNT too small for the requested number of processes

Explanation: The value of the OpenVMS SYSGEN parameter MAXPROCESSCNT is too small to allow RTR to handle the requested number of application processes. RTR will start, but fewer application processes can be handled than specified. Review the value of the /PROCESS qualifier to the START RTR command. MAXPROCESSCNT should be greater than 50 plus the number of processes specified.

%RTR-W-EXRCVYRETRIES, Too many recovery retries ([A]) for TX [A], facility [A], partition [A]

Explanation: The number of attempts to recover a TX exceeds the limit set on a partition with PARTITION/RECOVERY_RETRY_COUNT. This was detected on the node that opened the journal in which the TX is recorded.

%RTR-I-FACEXTNBE, Facility [A] extended with backend [A]

Explanation: The configuration of facility [A] has been extended to include the named node as a backend.

%RTR-I-FACEXTNFE, Facility [A] extended with frontend [A]

Explanation: The configuration of facility [A] has been extended to include the named node as a frontend.

%RTR-I-FACEXTNTR, Facility [A] extended with router [A]

Explanation: The configuration of facility [A] has been extended to include the named node as a router.

%RTR-I-FACLOSTBE, Facility [A] lost backend node [A]

Explanation: A connection with the named backend node was lost on facility [A]

RTR Log Messages

E.1 Operator Log Messages

%RTR-I-FACLOSTFE, Facility [A] lost Frontend node [A]

Explanation: This node is no longer a current router on facility [A] for the named frontend node

%RTR-I-FACLOSTTR, Facility [A] lost Router node [A]

Explanation: A connection was lost with the named router node on facility [A]

%RTR-E-FACNOTDEC, Facility name not matched

Explanation: A connection attempt was made to a remote node specifying a facility that does not (yet) exist on the remote node. Check that the facility name and the configuration match on all nodes concerned. If connecting to a V2 system, facility names must be specified in uppercase (all capital letters).

%RTR-E-FACNOTDEL, Facility [A] cannot be deleted while it has active partitions

Explanation: The specified facility could not be deleted because it has at least one active partition. For a partition to be considered inactive it must either have no servers or be in standby state. Stop any servers running on partitions within the facility on the node where the facility is to be deleted.

%RTR-I-FACROLEDEL, Node no longer configured for appropriate role

Explanation: This status can be returned as the reason status when a client channel is being shut down because the facility has been deleted or its configuration has been modified to exclude the appropriate role from the set of roles for this node.

%RTR-I-FACSTART, Facility [A] started on node [A]

Explanation: Facility [A] initialized on the named node

%RTR-I-FACSTARTBE, Facility [A] started on node [A] as backend

Explanation: A connection was established with the named backend node on facility [A]

%RTR-I-FACSTARTFE, Facility [A] started on node [A] as frontend

Explanation: This node is now a current router for the named frontend in facility [A]

%RTR-I-FACSTARTTR, Facility [A] started on node [A] as router

Explanation: A connection has been established with the named router node on facility [A]

RTR Log Messages

E.1 Operator Log Messages

%RTR-I-FACSTOP, Facility [A] stopped on node [A]

Explanation: Facility [A] on node [A] was stopped.

%RTR-I-FACSTOPPED, Facility [A] stopped on local node

Explanation: Facility [A] was stopped on the local node.

%RTR-I-FACTRMBE, Facility [A] modified: [A] no longer a backend

Explanation: The configuration of facility [A] has been modified to exclude the named node as a backend.

%RTR-I-FACTRMFE, Facility [A] modified: [A] no longer a frontend

Explanation: The configuration of facility [A] has been modified to exclude the named node as a frontend.

%RTR-I-FACTRMTR, Facility [A] modified: [A] no longer a router

Explanation: The configuration of facility [A] has been modified to exclude the named node as a router.

%RTR-I-HTTPSECOFF, The HTTP server component has been started with user authentication disabled

Explanation: The HTTP server was started with access control disabled.

%RTR-I-HTTPSTART, HTTP server started for user [A] [A]

Explanation: The HTTP server component was started.

%RTR-I-IGNREJACCEPTTX, Ignoring recovered aborted part-TX for committed TX

Explanation: A part-TX in the aborted state was recovered from the journal, but the TX is already in the committed state on the recovering node, so the aborted part-TX is ignored. This can only happen under unusual circumstances such as when the TX was rejected on one BE but the same TX was later accepted on another BE. (This might be caused by application inconsistency, or by an RTR condition such as a full journal.) RTR has ensured that the TX has been committed, but the operator should check the condition on the BE where the TX was aborted to determine why this happened (for example, there might be resource problems on the server).

RTR Log Messages

E.1 Operator Log Messages

%RTR-E-ILLIPCOP, IPC [A] completion with unexpected partner, process ID %08X

Explanation: RTR has detected IPC IO completion with a partner other than the expected IPC peer. This is likely due to illegal access to the mailboxes used by RTR for interprocess communication, and may be malicious in intent.

Investigate further the activities of the specified process with a view to terminating their illegal mailbox activity.

%RTR-E-ILLKRIDVAL, Illegal KRID value

Explanation: An attempt was made to free a krid already freed earlier, or the krid was invalid.

%RTR-I-IMAGEIS, Using image '[A]'

Explanation: Specifies an image name. Used to embellish the log file entry ILLIPCOP.

%RTR-F-INCOMPAT, Incompatible RTR versions

Explanation: Attempt to start an incompatible version of RTR on the same network with shared RTR facilities.

%RTR-E-INCONSRCVYTX, Inconsistent aborted part-TX ENQ1 %u JNL [A] FAC [A], committed TX ENQS %u CRP [A] FORGET [A]

Explanation: A partial, aborted transaction in an inconsistent state was encountered during recovery operations. It is not processed for recovery but deleted from the journal.

%RTR-F-INTERFERENCE, Group/system interference. Start RTR from another account

Explanation: Internal error. Submit a problem report.

%RTR-E-JNLENQMISSING, Enqueue %u (of transaction total %u) not found on partition [A] in recovery journal on [A]

Explanation: RTR has detected an inconsistency in the RTR journal during recovery. A transaction with some transaction data missing has been found in the journal. Save a copy of the journal and RTR log files and submit a problem report to RTR Engineering. The transaction could possibly be deleted using the RTR SET TRANSACTION command (after ensuring that the application has handled the transaction correctly), but RTR Engineering recommends that the journal be initialized using the RTR CREATE JOURNAL/SUPERSEDE command.

RTR Log Messages

E.1 Operator Log Messages

`%RTR-I-JNLRSG`, Journal host role resigned at the request of another member of the cluster

Explanation: Another member of the cluster has requested that the local node give up or resign hosting of its journal. The local node has determined that it is safe to accede to the request.

`%RTR-I-JNLRSGDCL`, Journal host role resignation declined

Explanation: Another member of the cluster has requested that the local node give up or resign hosting of its journal. The local node is currently unable to accede to this request because the shared resource is busy.

`%RTR-W-JNLSCNTRMNAT`, Journal scan terminated unexpectedly with error [A]

Explanation: Journal scan terminated unexpectedly. The reason for the unexpected scan termination is returned with this message.

`%RTR-I-JOUEXECWRIT`, Exception written to journal for transaction [A], previous state [A], reason status [A]

Explanation: An exception record has been written for the specified transaction. Manual intervention is required to see the transaction through to completion.

`%RTR-W-JOUFILFUL`, RTR journal file full - use `MODIFY JOURNAL` to increase size

Explanation: The RTR journal file is becoming full. Either reduce the number and size of concurrently active transactions or increase the size of the journal file using `MODIFY JOURNAL /MAXIMUM_BLOCKS`

`%RTR-E-JOUFULDEL`, Journal file full - transaction has been deleted

Explanation: The journal file is full and a message could not be written; the message was deleted from the journal file.

`%RTR-F-JOUHDRERR`, RTR journal record header error: use `CREATE JOURNAL /SUPERSEDE` and submit problem report

Explanation: An inconsistency was found in a record header within the RTR journal.

Corrective action:

- 1) Reissue the `RTR CREATE JOURNAL /SUPERSEDE` command.
- 2) Restart RTR.
- 3) Submit a problem report.

RTR Log Messages

E.1 Operator Log Messages

%RTR-E-JOUNOTAVA, Error during recovery ([A]) from [A] journal

Explanation: The RTR transaction manager requested recovery from a remote journal, but the request could not be delivered to the node hosting the journal. In a non-clustered standby configuration, this indicates that local recovery after a server failure could not be completed. No user action is required, because the transaction manager will attempt to send the recovery query again, once it has detected that the remote journal has become available.

%RTR-I-JOUNOTFUL, Journal file no longer full - journal write succeeded

Explanation: After failing to write the previous journal entry and aborting a transaction due to a full journal file, the entry was successfully written. It may still be advisable to review the journal file's available blocks to determine if there is sufficient space for continued processing.

%RTR-F-JOUOVERFL, RTR journal file overflow - transaction recovery information lost

Explanation: The journal file is so full that some transaction recovery information was discarded. One or more of the currently active transactions may be incorrectly recovered if a system failure occurs in the near future.

%RTR-E-JOUREADINC, Error reading journal file. The journal file appears to be corrupt or incomplete: use CREATE JOURNAL /SUPERSEDE and submit a problem report

Explanation: The RTR journal file(s) found are unusable. Submit a problem report.

%RTR-I-JOUREDEL, Rewriting delete record to journal for completed TX [A]

Explanation: The delete record for the completed transaction is being rewritten to the journal.

%RTR-I-JOUSEACOM, Journal search of node [A] facility [A] completed. [A] recoverable transactions found

Explanation: Journal search has completed. This message appears when the first facility with a backend role is created. The number of transactions needing recovery is indicated by [A].

RTR Log Messages

E.1 Operator Log Messages

%RTR-F-JOUSEQERR, RTR journal record sequence error: use CREATE JOURNAL /SUPERSEDE and submit a problem report

Explanation: An inconsistency was found in the record sequence in the RTR journal.

Corrective action:

- 1) Reissue the RTR CREATE JOURNAL /SUPERSEDE command.
- 2) Restart RTR.
- 3) Submit a problem report.

%RTR-E-JOUTXUNRECOV, Found pre-V3.2 transactions in journal for [A], unrecoverable using V4 recovery mode

Explanation: Transaction records were found in the journal that were written by a version of RTR earlier than V3.2. These transactions are unrecoverable using V4 recovery mode. Restart RTR with recovery mode set to V32 using the command RTR SET NODE/RECOVERY=V32 to recover these transactions.

%RTR-I-JOUTXVERSION, Journalled transactions written by RTR version %u, current version %u, facility [A]

Explanation: Transaction records were found in the journal that were written by another version of RTR.

%RTR-E-LINKSHUT, No longer accepting connect requests from this node

Explanation: A connection between a router and a frontend or a router and a backend can fail if the link is in the closed state. A link can be closed if RTR suspects it is causing network congestion, or by the system manager.

%RTR-F-LNQOVERFLOW, LNQ table has overflowed

Explanation: There are insufficient static reservations of the per-link congestion-queue header blocks. Submit a problem report.

%RTR-E-LNXINETADDRFAIL, RTR could not query one or more INET interfaces. Reason: [A]

Explanation: There was an error obtaining the IP address from one or more interfaces on the Linux system. RTR's call to the ioctl() function failed. [A] gives a description of the error.

If RTR cannot obtain the IP addresses for the local node through other means, remote commands, quorum, and other components may not work correctly.

RTR Log Messages

E.1 Operator Log Messages

If your hosts file (usually "/etc/hosts") contains an entry matching the node to the localhost, removing the reference will cause RTR to work correctly despite this error.

For example, the line "127.0.0.1 node localhost.localdomain localhost" causes the system call `gethostbyname()` to return '127.0.0.1' for 'node'. Thus, since RTR is unable to obtain the IP addresses from the INET devices, it will use '127.0.0.1' for 'node', instead of its true IP address. View the man page for `gethostbyname()` for more information.

%RTR-E-LNXINETNOIP, Could not obtain an IP address from any INET interface on the Linux system.

Explanation: RTR could not find any IP addresses from the INET interfaces on the Linux system.

If RTR cannot obtain the IP addresses for the local node through other means, remote commands, quorum, and other components may not work correctly.

If your hosts file (usually "/etc/hosts") contains an entry matching the node to the localhost, removing the reference will cause RTR to work correctly despite this error.

For example, the line "127.0.0.1 node localhost.localdomain localhost" causes the system call `gethostbyname()` to return '127.0.0.1' for 'node'. Thus, since RTR is unable to obtain the IP addresses from the INET devices, it will use '127.0.0.1' for 'node', instead of its true IP address. View the man page for `gethostbyname()` for more information.

%RTR-E-LNXINETSOCKFAIL, RTR could not obtain IP addresses for any INET interfaces. Reason: [A]

Explanation: There was an error obtaining the IP addresses from all INET interfaces on the Linux system. RTR was unable to open an INET socket. [A] contains a description of the error.

If RTR cannot obtain the IP addresses for the local node through other means, remote commands, quorum, and other components may not work correctly.

If your hosts file (usually "/etc/hosts") contains an entry matching the node to the localhost, removing the reference will cause RTR to work correctly despite this error.

RTR Log Messages

E.1 Operator Log Messages

For example, the line "127.0.0.1 node localhost.localdomain localhost" causes the system call `gethostbyname()` to return '127.0.0.1' for 'node'. Thus, since RTR is unable to obtain the IP addresses from the INET devices, it will use '127.0.0.1' for 'node', instead of its true IP address. View the man page for `gethostbyname()` for more information.

%RTR-E-LOADLIBFAIL, Unable to dynamically load the shared library

Explanation: The RTRACP could not load the shared library dynamically.

%RTR-E-LOADSYMFALL, Unable to find the symbol in the shared library

Explanation: The RTRACP could not locate the symbol name in the dynamically-loaded library.

%RTR-I-LOGFILENT, [A] [A] [A]

Explanation: Displays the time/date, node name and user name associated with the subsequent error message.

%RTR-E-LRCERROR, Found an LRC error in an incoming message

Explanation: The checksum, also known as the Linear Redundancy Check, was wrong in an incoming message.

%RTR-W-MESFLOCON, Message flow congestion on link to node [A] for facility [A]

Explanation: RTR internode communication has become congested. New messages are waiting for the congestion to clear.

%RTR-W-NEEDV33TR, [A] router in facility [A] incompatible, need V3.3 or later for [A] journal recovery, trying [A]

Explanation: To upgrade to V3.3 or later, RTR routers must first be upgraded. This is not always possible in environments that have mixed facility definitions on one node. During recovery from the journal, if RTR detects that the router is an incompatible version, it will try to find another router with the minimum supported version.

No action is required if recovery is successful. This warning is a reminder that there are routers running with incompatible versions of RTR that should be upgraded in the near future. If recovery fails, then the routers will need to be upgraded.

%RTR-F-NETSHUT, Network has been shut down or has become unusable ([A]) - automatic retry will follow

Explanation: DECnet or TCP/IP was stopped on a node running RTR. This can also occur if the network fails or otherwise becomes unusable.

RTR Log Messages

E.1 Operator Log Messages

%RTR-E-NOBINDADDR, Unable to resolve bind host to INET address: [A]

Explanation: The specified bind host name could not be resolved to an Internet address. This is a serious error as it prevents RTR from listening for and accepting incoming network connections.

Correct the supplied value for the bind host, or resolve any name lookup issues.

%RTR-E-NOCURRTR, Current router search failed for facility [A]

Explanation: None of the routers specified for facility [A] are currently connectable. The search will continue after a short interval.

%RTR-W-NODENOTCNFG, Node is not configured for the facility

Explanation: A connection attempt to a remote node failed. The connecting link is not configured in the requested facility at the remote node.

%RTR-W-NODISOLAT, Isolating [A] - node suspected of causing congestion

Explanation: The remote node [A] has been diagnosed as causing network congestion; RTR will isolate the node from the rest of the network.

%RTR-W-NOFECREDIT, No credit for FE connect acceptance

Explanation: The router has no credit left to accept any more frontends at the moment. Other routers can be tried.

%RTR-F-NOMOREPRT, No more partition slots available

Explanation: RTR is unable to create an additional partition since the limit on the number of partitions on this backend has been reached. Use the /Partitions qualifier to the 'start rtr' command to specify a higher limit. The default value for this limit is 500 partitions. The maximum permitted value is 65536.

%RTR-E-NORULES, The system.mon file has no rules by which this node can monitor itself

Explanation: This node has no rules by which it can monitor itself. Please verify that the system.mon file exists and that it contains REMEMBER EXPRESSION commands by which this node can monitor itself.

%RTR-E-NOTCONFIGURED, RTR not configured on [A] to recognize this node

Explanation: None of the facilities defined on the local node [A] defined a valid role for the remote node to permit a connection.

RTR Log Messages

E.1 Operator Log Messages

%RTR-E-NOTRECOGNISED, Node not recognized

Explanation: Result of a connection attempt to a remote node where no facility references the connecting link at the remote node.

%RTR-W-NULLNSAPVETO, Vetoing null DECnet+/IP V4 NSAP

Explanation: This entry indicates that RTR has encountered a null IP NSAP when enumerating the available address towers for the local node. This occurs when using DECnet+ configured for DECnet over IP, at a time early in the system before DECnet has learnt the addresses of the available IP network interfaces.

Any null IP NSAPs so discovered are ignored. RTR will create appropriate NSAP entries from IP host name definitions for the local node (if defined, and if RTR IP networking is enabled for the node).

The problem can be avoided by ensuring the local node has completed some outbound DECnet connections over IP prior to starting RTR, for example:

```
$ dir 'f$trlnm( "TCPIP$INET_HOST")'.f$trlnm( "TCPIP$INET_
DOMAIN")::/total
```

%RTR-E-OBJNOTDECL, RTR network object could not be established - will try again later

Explanation: RTR could not establish a network object, most likely because the network was not available. A subsequent entry gives more detail on the error. RTR will retry the operation later, but the operator should investigate the state of the network.

%RTR-E-OBJUNKNOWN, RTRACP not running on node [A]

Explanation: A connection failed because RTR had not been started or had died on the remote node [A].

%RTR-E-ORPHANSHADTX, Transaction copied to secondary shadow journal, no longer found on primary

Explanation: Remembered transaction was partially copied from primary to secondary journal. Transaction can no longer be found in primary journal. Submit a problem report. The transaction can be exceptioned or removed from the secondary journal using the RTR SET TRANSACTION command.

%RTR-E-OVERFLOW, Table has overflowed, resize NCF

Explanation: There are insufficient static reservations for the NCF tables. Submit a problem report with an RTRACP dump.

RTR Log Messages

E.1 Operator Log Messages

%RTR-I-PATHLOST, Node [A] unreachable, retrying

Explanation: Node [A] cannot be reached at present. This generally means that RTR is trying to reestablish a connection.

%RTR-E-PRCDMPERR, An error occurred while dumping the process.
Reason: [A][A]

Explanation: An error occurred that prevented the DUMP PROCESS command from dumping all or part of the process into a raw dump file. The reason for the failure is given. This command is invoked automatically in certain conditions, including a process crash.

If successful, the raw dump file may later be analyzed by the appropriate personnel.

%RTR-E-PROTOCOL, Incorrect protocol in optional data

Explanation: An internal error has occurred in messages between RTRACPs. This may be caused by network packet data loss or corruption, so consider a network health check. If the condition persists, submit a problem report.

%RTR-E-PRTBADCMD, Partition command invalid or not implemented in this version of RTR

Explanation: The RTRACP received a request for an unknown partition command.

%RTR-I-PRTBEGIN, Partition %u/[A]:[A] start up, server pid [A] image [A]

Explanation: The first server started on a backend partition. This message has been superseded by %RTR-I-PRTBESTRA

%RTR-I-PRTCMDFRMBE, Command received for partition [A]:[A] from backend node [A]

Explanation: The message indicates the source or origin of a command.

%RTR-I-PRTCREATED, Pid %8s created [A]/[A]:[A] [A]

Explanation: A partition was created on the backend.

%RTR-E-PRTDELCAN, Partition deleted - operation cancelled

Explanation: A pending operation was terminated because the partition was deleted before completion of the operation.

%RTR-I-PRTDELETED, Partition [A]:[A] deleted

Explanation: A backend partition was deleted.

RTR Log Messages

E.1 Operator Log Messages

%RTR-W-PRTEND, Pid %8s ended [A]/[A]:[A]

Explanation: The last server on a backend partition exited.

%RTR-I-PRTJNLSTA, Starting rundown journal scan for partition [A]:[A]

Explanation: The partition rundown journal scan started on a backend.

%RTR-W-PRTLCLRECEXIT, Partition [A]:[A] local recovery terminated by operator [A]

Explanation: The operator has requested a recovery wait override.

%RTR-I-PRTNEWFPOL, Failover policy for partition [A]:[A] set to [A] by operator [A]

Explanation: An operator request to change the failover policy of the indicated partition was accepted. This message can also appear when RTR automatically switches to pre-V3.2 compatibility mode.

%RTR-I-PRTNEWFPOLBE, Failover policy change for partition [A]:[A] received from router [A]: new policy [A]

Explanation: A backend received an operator request to change the failover policy of the indicated partition. This message also appears when RTR automatically switches to pre-V3.2 compatibility mode.

%RTR-I-PRTNEWFPOLTR, Failover policy change for partition [A]:[A] received from backend [A]: new policy [A]

Explanation: A router received an operator request to change the failover policy of the indicated partition. This message can also appear when RTR automatically switches to pre-V3.2 compatibility mode.

%RTR-I-PRTNEWPRI, Priority for partition [A]:[A] set to %u by operator [A]

Explanation: An operator request to change the backend priorities of the indicated partition has been accepted.

%RTR-I-PRTNEWPRITR, Priority change for partition [A]:[A] received from backend [A], new priority %u

Explanation: A router has received an operator request to change the priority of the indicated partition.

%RTR-S-PRTRESUMED, Partition [A]:[A] resumed by operator [A]

Explanation: A partition resume command completed successfully. Transaction presentation is now enabled.

RTR Log Messages

E.1 Operator Log Messages

%RTR-W-PRTRSTRCVY, Partition [A]:[A] recovery initiated by operator [A]

Explanation: The operator has manually initiated partition recovery.

%RTR-I-PRTSCANJNL, Partition %u scanning journal for node id [A]

Explanation: RTR is accessing the journal for node [A] that may contain relevant recovery information for the specified key range.

%RTR-E-PRTSETFAILTR, Router unable to process command

Explanation: A partition SET command failed at the router. An entry is written to the log file describing the problem. Message arguments are the facility name and the KR ID (key range identification). A second message is written detailing the nature of the problem.

%RTR-W-PRTSHDRECEXIT, Partition [A]:[A] shadow recovery terminated by operator [A]

Explanation: The operator has requested a recovery wait override.

%RTR-I-PRTSHDWOFF, Command SET PARTITION SHADOW STATE OFF received

Explanation: A request to set the partition shadow state to off has been received by the router.

%RTR-I-PRTSHDWON, Command SET PARTITION SHADOW STATE ON received

Explanation: A request to set the partition shadow state to on has been received by the router.

%RTR-I-PRTSTATRA, From %13s to %13s, [A]/[A]:[A]

Explanation: A backend partition changed state.

%RTR-I-PRTSUSPCAN, Suspend cancelled for partition [A]:[A], operator [A] - partition resumed by operator

Explanation: A pending partition suspend operation has been cancelled as a result of an operator command to resume the partition.

%RTR-S-PRTSUSPEND, Partition [A]:[A] suspended by operator [A]

Explanation: A partition has become suspended as the result of operator intervention.

RTR Log Messages

E.1 Operator Log Messages

%RTR-E-PRTSUSPTMO, Suspend timeout for partition [A]:[A], operator [A] after [A] seconds - partition still suspending

Explanation: A command to suspend a partition timed out. The partition will still be suspending - resume the partition to restart presentation of transactions.

%RTR-W-PRTWAITJNL, Partition %u waiting for access to journal for node [A]

Explanation: RTR cannot access one or more journals that may contain relevant recovery information for this key range. The journal referenced could be one of several unavailable journals. Either RTR should be started on the missing backend or the facility should be trimmed and the server restarted.

%RTR-F-QAROVERFLOW, No more QARs left

Explanation: There are insufficient static reservations for the internal QARs (query acceptor records). Record all QRM counters using SHOW RTR /COUNTER=qrm* and submit a problem report with the corresponding RTRACP dump.

%RTR-F-QCROVERFLOW, QCR table has overflowed

Explanation: There are insufficient static reservations for the internal QCRs (query context record descriptors). Submit a problem report.

%RTR-F-QIROVERFLOW, No more QIRs left

Explanation: There are insufficient static reservations for the internal QIRs (query initiation record descriptors). Record all QRM counters using SHOW RTR /COUNTER=qrm* and submit a problem report with the corresponding RTRACP dump.

%RTR-F-RAEOVERFLOW, No more RAEs

Explanation: There are insufficient static reservations for the internal RAEs (response acceptor elements). Record all QRM counters using SHOW RTR /COUNTER=qrm* and submit a problem report with the corresponding RTRACP dump.

%RTR-W-RCVYWAITJOU, Recovery suspended on [A] since [A] because RTR journal is full - use MODIFY JOURNAL to increase size

Explanation: Recovery is suspended on a Key Range because the RTR journal file is full. Increase the size of the journal file on the recovering backend using MODIFY JOURNAL /MAXIMUM_BLOCKS.

RTR Log Messages

E.1 Operator Log Messages

%RTR-F-RDEOVERFLOW, RDE table has overflowed

Explanation: There are insufficient static reservations for the internal RDEs (response dispatch elements). Record all QRM counters using `SHOW RTR /COUNTER=qrm*` and submit a problem report with the corresponding RTRACP dump.

%RTR-E-REQDIED, Client exited, incomplete transaction aborted

Explanation: A client exited before completing a transaction.

%RTR-E-REQDIEDPREP, Client exited after calling `rtr_prepare_tx`, transaction unresolved

Explanation: A client exited after preparing a transaction.

%RTR-E-REQDIEDVOT, Client exited after issuing `rtr_accept_tx`, awaiting transaction result

Explanation: A client died after accepting a transaction, but before completion of the transaction.

%RTR-W-RESERVECORRUPT, Reserve memory size was corrupted. The value %u has been reset to %u.

Explanation: Reserve memory size in shared memory was corrupted. The value [A] was either too large or too small; it has been set to the specified default value.

See the `/RESERVE_MEMORY_SIZE` qualifier of the `START RTR` command for more information on reserve memory size.

To obtain a reserve memory size other than the default, restart RTR specifying the desired value with the `/RESERVE_MEMORY_SIZE` qualifier.

%RTR-W-ROLESMismatch, Node role definitions do not match for this facility

Explanation: The facility exists, but the definition of the role for the remote node is not the same as the one in the local node. The facilities on the two nodes concerned have been defined inconsistently.

RTR Log Messages

E.1 Operator Log Messages

`%RTR-E-ROUTERUNAVAILTMO`, FE discarded transaction due to router unavailability timeout

Explanation: Rarely a transaction can be aborted by an RTR frontend with this status. This can occur if an RTR client application has accepted the transaction but the link to the router is lost before the RTR frontend receives a response from the router. If no RTR router becomes available for more than eight minutes, the transaction is aborted by the frontend. This prevents the transaction being duplicated by RTR, because the router unanimously decides the outcome of accepted transactions that have lost their frontends after about 10 minutes. The client application should check whether the transaction has been completed, once the link to a router is re-established.

`%RTR-W-ROUTERVSNLOW`, Router [A] is incapable of providing data for the `rtr_request_info()` call for the 'gcs' info class

Explanation: This backend encountered a request, via the API call `rtr_request_info()`, for information in the global configuration and status (gcs) information class. To satisfy the request, the backend must gather data from all routers. However, router [A] is running an RTR version that is too old to understand the request. Consequently, the information returned from the request will be incomplete.

To ensure complete and accurate data, please upgrade all routers to a version that contains the RTR Explorer.

For more information on the global configuration and status information class, see the documentation on the `rtr_request_info()` API call.

`%RTR-W-ROUTETIMEOUT`, A router failed to respond within the time limit of `%u` seconds

Explanation: An `rtr_request_info()` API call was executed on the backend using the GCS information class, and the backend requested the pertinent information from all routers. However, at least one router failed to respond within the time limit.

See the command `SET NODE/ROUTER_RESPONSE_TIMEOUT` for more information.

`%RTR-I-RQEQUALS`, Transaction client was [A]

Explanation: Displays the process name of the client [A] in messages relating to transactions.

RTR Log Messages

E.1 Operator Log Messages

%RTR-W-RSPFAC, Response from Node [A] about Facility [A]

Explanation: A negotiation with remote node [A] about the named facility has failed for the reason reported in the following line. The system manager may need to intervene.

%RTR-W-RSPNODE, Connection to node [A] failed : reason is

Explanation: A negotiation with remote node [A] has failed for the reason reported in the following line. The system manager may need to intervene.

%RTR-F-RTRACPFail, RTRACP failed - diagnostics written to [A]

Explanation: The RTRACP process has failed. Submit a problem report with supporting information on the current commands.

%RTR-E-RTRNEEDUPGRADE, Node [A] in facility [A] has a higher, incompatible RTR version. Please upgrade

Explanation: Node [A] in the named facility has a higher RTR version than this router. This router is unable to understand the message and so the gcs information class in rtr_request_info will be incomplete. Please upgrade RTR on this router.

%RTR-E-RTRSTS, [A]

Explanation: A call to an RTR core API call caused an unexpected condition. Such an entry in the log file may be generated by transaction manager calls to the RTR XA interface. Other uses may exist. Read the error text to determine what action may be taken to rectify the situation. Conditions that cannot be remedied should be submitted in a problem report through the usual support procedures.

%RTR-W-SETABORTIGNORED, SET TRAN asked router to abort a tx (id=[A]) in [A] state

Explanation: An RTR backend believed a transaction is in the JNL_VOTED state and asked the RTR router to abort this transaction. However, the RTR router could not abort this transaction because the transaction on the router side has already been committed or aborted. The RTR router could not process this SET TRAN ABORT request, but ignored it and logged this warning.

RTR Log Messages

E.1 Operator Log Messages

%RTR-W-SETABORTNFOUND, Router could not abort a tx ([A]) that does not exist

Explanation: An RTR backend used the SET TRANSACTION command to request that the RTR router abort a transaction that is in the JNL_VOTED state, but the RTR router could not find this transaction which may have been forgotten. The RTR router could not process this SET TRAN ABORT request, but ignored it and logged this warning.

%RTR-I-SETTRAN, Facility:[A] partition:[A] tx:[A] old:[A] new:[A] since:[A] before:[A] user:[A] by operator [A]

Explanation: A SET TRANSACTION command was issued.

%RTR-I-SETTRANEND, Status [A], [A] transactions updated in partition [A] of facility [A]

Explanation: A SET TRANSACTION command completed.

%RTR-E-SRVABOREC, Server aborted transaction recovery, check database consistency

Explanation: A server aborted a transaction that was being recovered after an earlier failure.

%RTR-E-SRVDIEDCOM, Server exited after being told to commit, check commit was completed

Explanation: A server exited after being told to commit a transaction.

%RTR-E-SRVDIEDREC, Server exited during transaction recovery, check database consistency

Explanation: A server exited while performing recovery of transactions lost on an earlier failure.

%RTR-E-SRVDIEDVOT, Server exited after voting on transaction, awaiting transaction result

Explanation: A server exited before completing a transaction.

%RTR-I-STATECHANGED, TX [A] journal state changed from [A] to [A]

Explanation: A transaction's key-range journal state (tkj) has changed.

%RTR-E-TCPREQUIRED, HTTP server requires TCP, but this is unavailable or disabled

Explanation: HTTP server requires TCP, so before starting the http server, it checks whether TCP is enabled. If TCP is not enabled, then RTR will not be accessible from a web browser.

RTR Log Messages

E.1 Operator Log Messages

`%RTR-E-THREADREQD`, Use of this feature requires the threaded RTR shareable (`librtr_r`)

Explanation: The caller attempted to access RTR with multiple threads using the unthreaded RTR shareable. This condition is raised by the RTR XA (RM) interface. To eliminate this error, use `librtr_r`, not `librtr`.

`%RTR-I-TIMEEQUALS`, Issued at [A]

Explanation: Displays the transaction start time [A] in messages relating to transactions.

`%RTR-W-TOOMANYNETIDS`, Too many net IDs for node [A] - check for and eliminate any unnecessary adapter/protocol combinations

Explanation: On a system configured to run multiple network protocols over multiple adapters, RTR can run out of space to store and communicate the resultant node IDs. RTR may be able to operate under this condition, but we recommend a review of the system configuration to eliminate any unnecessary adapter/protocol combinations.

`%RTR-E-TOOMANYTRBE`, The number of router or backend nodes in facility [A] is too large for this version of RTR

Explanation: The number of router or backend roles in a facility exceeds the capabilities of the current version of RTR. Contact RTR support for further information.

`%RTR-I-TRINQUO`, Router is quorate in facility [A]

Explanation: The router role now has quorum in the facility [A]

`%RTR-W-TRNOQUO`, Router has no quorum in facility [A]

Explanation: The router role has lost quorum for facility [A]

`%RTR-I-TXIDEQUALS`, Transaction ID [A]

Explanation: Displays the transaction identification [A] in messages relating to transactions.

`%RTR-E-WRONGSERVER`, Connection attempt to wrong command server: originating node [A], username [A]

Explanation: The HTTP-enabled command server found that the credentials presented by an HTTP client identified a username other than that under which the server is running. This could arise if the command server were restarted, which could invalidate some links in a current HTML display, or more seriously be an indication of system probing by

RTR Log Messages

E.1 Operator Log Messages

unauthorized users. Frequent occurrence of this error will cause the client node to be disabled for a period of time.

Index

46000
port, 2-38

A

Accfail monitor, 8-6
Accounts, 7-1
Acp2app monitor, 8-7
Active monitor, 8-8
Adapters
 multiple network, 2-42
Addressing
 dynamic, 2-4
Aggregation of Data Items, A-7
Alarm monitor, 8-9
Analyzing RTR application performance,
 7-4
Anonymous client, 9-75
App2acp monitor, 8-9
Appdelay monitor, 8-10
Application performance
 analyzing RTR, 7-4
Application permission, 2-18
Arithmetic operators, A-6
AUTOGEN, 2-28

B

Backend, 2-2
Backend server states, 5-10
Backlog
 transaction, 2-7
BAR
 DISPLAY, 9-113

.bat procedure, 1-23
Binding ports, 2-38
Branch
 transaction, 4-1
Break-in detection, B-5
Broadcast monitor, 8-10
Browser interface, 1-3

C

Caching user credentials, B-5
Call
 RTR_ACCEPT_TX, 9-4
CALL
 RTR_BROADCAST_EVENT, 9-8
 RTR_CLOSE_CHANNEL, 9-13
 RTR_ERROR_TEXT, 9-16
 RTR_EXT_BROADCAST_EVENT, 9-18
 RTR_GET_TID, 9-23
 RTR_GET_USER_CONTEXT, 9-26
 RTR_OPEN_CHANNEL, 9-28
 RTR_RECEIVE_MESSAGE, 9-39
 RTR_REJECT_TX, 9-44
 RTR_REPLY_TO_CLIENT, 9-47
 RTR_REQUEST_INFO, 9-52
 RTR_SEND_TO_SERVER, 9-55
 RTR_SET_USER_CONTEXT, 9-60
 RTR_START_TX, 9-62
Callout server, 2-12
Calls monitor, 8-11
CHANNEL
 SHOW, 9-229
CHANNELCNT, 2-28

- Channel monitor, 8–12
- Channels, 2–28
- Character
 - continuation, 2–3
- Classes
 - information, A–2
- CLEAR, 9–66, A–3
- CLI call interface
 - RTR_ACCEPT_TX, 9–4
 - RTR_BROADCAST_EVENT, 9–8
 - RTR_CLOSE_CHANNEL, 9–13
 - RTR_ERROR_TEXT, 9–16
 - RTR_EXT_BROADCAST_EVENT, 9–18
 - RTR_GET_TID, 9–23
 - RTR_GET_USER_CONTEXT, 9–26
 - RTR_OPEN_CHANNEL, 9–28
 - RTR_RECEIVE_MESSAGE, 9–39
 - RTR_REJECT_TX, 9–44
 - RTR_REPLY_TO_CLIENT, 9–47
 - RTR_REQUEST_INFO, 9–52
 - RTR_SEND_TO_SERVER, 9–55
 - RTR_SET_USER_CONTEXT, 9–60
 - RTR_START_TX, 9–62
- Client, 2–2
 - anonymous, 9–75
- CLIENT
 - SHOW, 9–231
- Client States, 5–11
- Clustering, 2–50
 - host-based, 2–54
- Clusters
 - recognized, 1–24
 - unrecognized, 2–55
- Command
 - procedures, 1–23
 - recall, 9–186
 - remote, 1–24
- Command remember, 9–191
- Commands
 - entering partition, 3–4
- Compression
 - level, 2–26
 - reply, 2–26

- Compress monitor, 8–12
- Concurrent processes, 2–16
- Concurrent server, 9–84
- Connect failures, 2–42, 7–7
- CONNECTIONPOOL
 - CREATE, 9–68
 - DELETE, 9–96
 - MODIFY, 9–169
 - SHOW, 9–233
- Connections
 - IP, 2–42
- Connects monitor, 8–14
- Continuation character, xxi, 2–3
- Controlling recovery, 3–8
- Counters
 - export, 9–156
- CREATE
 - CONNECTIONPOOL, 9–68
 - DATASOURCE, 9–72
 - FACILITY, 2–1, 9–74
 - JOURNAL, 2–5, 9–79
 - PARTITION, 9–83
 - SERVICEPROVIDER, 9–89
- Creating a recovery journal, 2–5
- Credit, 2–28, 7–6
- Ctccalls monitor, 8–15
- Current router, 2–50
- Customize HTML pages, B–1

D

- Data items, 8–1, A–1
- DATASOURCE
 - CREATE, 9–72
 - DELETE, 9–98
 - MODIFY, 9–173
 - SHOW, 9–235
- DCL interface, 9–1
- Deadlock, 4–5
- DECnet protocol, 2–38
- Decompression
 - reply, 2–26
- DEFINE
 - KEY, 9–92

DELETE

- CONNECTIONPOOL, 9–96
- DATASOURCE, 9–98
- FACILITY, 9–100
- JOURNAL, 9–102
- PARTITION, 9–104
- SERVICEPROVIDER, 9–106

Detection interval, 9–257

Disks

- dual-ported, 2–52
- striped, 2–6

Display

- Expressions, A–6

DISPLAY, A–3

- BAR, 9–113
- NUMERIC, 9–121
- SHOW, 9–237, A–3
- STRING, 9–128
- SYMBOLIC, 9–134
- TEXT, 9–138

DNA protocol, 2–38

DNS, 2–39

DO

- DCL command, 9–143

Domain Name System, 2–39

Downstream monitor, 8–15

DTC Support, C–4

Dual-ported disks, 2–52

Dual-rail, 2–35

- setup, 2–39

DUMP

- JOURNAL, 9–146

Dump file, 2–29

Dumps, 7–10

Dynamic addressing, 2–4

E

ENVIRONMENT

- SET, 1–25, 9–197
- SHOW, 9–239

Environment variable, 2–23

- break-in detection, B–5
- flow control, 2–27
- local node euphemism, 2–32

Environment variable (cont'd)

- password cache, B–5
- RTR\$DUMP_DIRECTORY, 2–29
- RTR_BIND_HOST, 2–34
- RTR_DEFAULT_NODE_*, 2–31
- RTR_DIRECTORY, 2–29
- RTR_EVENT_COMPRESS_*, 2–33
- RTR_FE_NOTIFICATION, 2–30
- RTR_GOAL_RESPONSE, 2–31
- RTR_JNL_*, 2–31
- RTR_LGI_*, 2–34
- RTR_MAX_CHANNEL_*, 2–33
- RTR_PREF_PROT, 2–34
- RTR_REPLY_COMPRESS_*, 2–33
- RTR_TCP | DNA_FIRST, 2–34
- RTR_TCP | DNA_ONLY, 2–34
- RTR_TCP | DNA_PREFIX, 2–34
- RTR_TUNNEL_PREFIX, 2–34
- SYS\$NODE, 2–29
- WAIT_Q, 2–33

Error log, 2–29, 9–203

Errors, 1–22

Event monitor, 8–15

Exception record, 3–11

Exception transactions, 4–3

- data integrity, 4–4

EXECUTE, 9–154

EXIT, 9–155

Explorer monitor, 8–16

Export counters, 9–156

EXTEND

- FACILITY, 9–158

F

Facility, 1–2

- create, 2–1
- starting, 7–3

FACILITY

- CREATE, 9–74
- DELETE, 9–100
- EXTEND, 2–8, 9–158
- SET, 9–199
- SHOW, 9–240
- TRIM, 2–7, 9–302

- Failback, 2-14, 2-50
 - partition, 2-25
 - standby, 2-25
- Failover policy
 - setting, 2-49
- Failures
 - link connect, 7-7
- FastRecovery Monitor, 8-17
- Fast-shadow recovery, 2-7
- Feature
 - three strikes, 9-222
- @file, 1-23
- Firewall, 2-40
- Flostalls monitor, 8-17
- Flow control, 2-27, 2-28
- Flow monitor, 8-17
- FLUSH
 - NAME_CACHE, 9-164
- Frontend, 2-2
- Frontend client states, 5-11
- Frontend monitor, 8-18

G

- Group mode, 9-211
- Group monitor, 8-18

H

- Help, 1-22
- Host-based clustering, 2-54
- Hosts
 - unreachable, 2-42
- HTTP_SERVER
 - START, 9-290
 - STOP, 9-299

I

- INET, 2-43
- Information classes, A-2
- Interface
 - web browser, 1-3

- Interval
 - detection, 9-257
- Invoking RTR, 9-194
- Ipc monitor, 8-19
- IP connections, 2-42
- Ipcrate monitor, 8-20

J

- Jcalls monitor, 8-21
- Journal
 - initialization, 2-5
 - release, 2-25
 - sizing, 5-6
- JOURNAL
 - CREATE, 9-79
 - DELETE, 9-102
 - DUMP, 9-146
 - JOURNAL, 2-5
 - MODIFY, 9-175
 - SHOW, 9-245
- Journal file
 - RTR, 1-1
- Journal monitor, 8-21
- Juse monitor, 8-22

K

- Key
 - routing, 3-1
- KEY
 - DEFINE, 9-92
 - SHOW, 9-248
- Killer message during replay, 3-11

L

- Life cycle of a partition, 3-3
- LINK
 - SET, 9-202
 - SHOW, 9-250
- Link connect failures, 7-7
- Link monitor, 8-22

- Link problems, 2–15
- Linux support, 2–43
- Load balancing, 2–14
- Local routers, 2–13
- Log
 - error, 9–203
- LOG, 9–167
 - SET, 9–207
 - SHOW, 9–253
- Log file
 - RTR, 1–2
- Logging, 7–3
- Logout
 - Windows user, 1–25
- Lrc monitor, 8–23

M

- Management monitor, 8–24
- Master router, 2–50
- MAXPROCCNT, 2–28
- Memory
 - shared, 2–23
 - virtual, 2–18
- Memory quota
 - WAITQ, 2–28
- Minimum transaction timeout, 9–64
- Mode
 - group, 9–211
 - nogroup, 9–211
 - remember, 2–7
 - system, 9–211
- MODE
 - SET, 9–211
 - SHOW, 9–255
- MODIFY
 - CONNECTIONPOOL, 9–169
 - DATASOURCE, 9–173
 - JOURNAL, 9–175
 - SERVICEPROVIDER, 9–178
- MODPARAMS.DAT, 2–28
- Monitor
 - Accfail, 8–6
 - Acp2app, 8–7
 - Active, 8–8

- Monitor (cont'd)
 - Alarm, 8–9
 - App2acp, 8–9
 - Appdelay, 8–10
 - Broadcast, 8–10
 - Calls, 8–11
 - Channel, 8–12
 - Compress, 8–12
 - Connects, 8–14
 - Ctccalls, 8–15
 - Downstream, 8–15
 - Event, 8–15
 - Explorer, 8–16
 - FastRecovery, 8–17
 - Flostalls, 8–17
 - Flow, 8–17
 - Frontend, 8–18
 - Group, 8–18
 - Ipc, 8–19
 - Ipcrate, 8–20
 - Jcalls, 8–21
 - Journal, 8–21
 - Just, 8–22
 - Link, 8–22
 - Lrc, 8–23
 - Management, 8–24
 - Netbytes, 8–25
 - Netstat, 2–42, 8–26
 - Ortr, 8–27
 - Partit, 8–27
 - Queues, 8–28
 - Quorum, 8–28
 - Recovery, 8–29
 - Rejects, 8–30
 - Rejhist, 8–31
 - Response, 8–31
 - Rolequor, 8–32
 - Routers, 8–32
 - Routing, 8–33
 - Rscbe, 8–33
 - RTR, 8–1
 - Stalls, 8–34
 - Stccalls, 8–35
 - Summary, 8–35
 - System, 8–37

Monitor (cont'd)

- Tps, 8-38
 - Tpslo, 8-39
 - Traffic, 8-39
 - Trans, 8-39
 - Upstream, 8-40
 - V2calls, 8-40
 - Wq_facility, 8-41
 - Wq_process, 8-41
 - XA, 8-42
- MONITOR, 8-1, 9-181
- Monitor file, 8-1
- Monitor pictures, 7-1, 8-1, A-2
- Monitor Queues, 2-7
- Monitor screen, A-2
- Multihome setup, 2-39
- Multihoming, 2-35, 2-42
- Multiple network adapters, 2-42

N

NAME_CACHE

- FLUSH, 9-164
- Netbytes monitor, 8-25
- Netstat monitor, 8-26
- Network adapters
- multiple, 2-42
- Network card, 2-39
- Network transports, 2-35
- NODE
- SET, 9-214
 - SHOW, 9-257
- Nogroup mode, 9-211
- Notification variable, 2-30
- NUMERIC
- DISPLAY, 9-121

O

- Operating system command
- SPAWN, 9-143, 9-288
- Operators
- arithmetic, A-6
- Order
- priority list, 2-49

- Ortr monitor, 8-27

P

Partition

- definition, 3-1
 - failback, 2-25
 - life cycle, 3-3
 - naming, 3-2
 - states, 5-1
- PARTITION
- CREATE, 9-83
 - DELETE, 9-104
 - SET, 9-219
 - SHOW, 9-260
- Partition commands
- entering, 3-4
- Partition states
- router, 5-12
- Partit monitor, 8-27

Permission

- application, 2-18
- PGFLQUOTA
- RTR, 9-295

Picture

- monitor, A-2

Policy

- setting failover, 2-49

Port

- 46000, 2-38
 - binding, 2-38
- Preferred router, 2-14, 2-50
- Primary active state, 2-7
- Priority list order, 2-49

Privileges

- RTR\$INFO, 2-17
- RTR\$OPERATOR, 2-17
- rtrinfo, 2-17
- rtroper, 2-17

- Problem report submitting, 7-8

PROCESS

- SHOW, 9-265

Processes

- concurrent, 2-16

Prompt symbol, 1–3
Protocol
 DECnet, 2–38
 DNA, 2–38
 recovery version, 9–272
 TCP/IP, 2–38
Proxy accounts, 7–1

Q

Queues monitor, 8–28
QUIT, 9–185
Quorum monitor, 8–28
Quorum threshold
 setting, 9–200

R

RECALL, 9–186
Recognized clusters, 1–24
Record
 exception, 3–11
Recovery
 controlling, 3–8
 fast-shadow, 2–7
 server, 5–1
Recovery journal
 creating, 2–5
Recovery monitor, 8–29
Recovery protocol
 version, 9–272
REGISTER
 RESOURCE_MANAGER, 9–188
 RM, 9–188
Register RM, C–2
Rejected transactions, 7–8
Rejects monitor, 8–30
Rejhist monitor, 8–31
Release
 journal, 2–25
REMEMBER, 9–191
Remember mode, 2–7
Remote commands, 1–24, 2–4

Replay
 transaction, 3–11
REQUESTER
 SHOW, 9–267
RESOURCE_MANAGER
 REGISTER, 9–188
 SHOW, 9–268
 UNREGISTER, 9–306
Response monitor, 8–31
Response time
 environment variable, 2–31
RM
 REGISTER, 9–188
 SHOW, 9–268
 UNREGISTER, 9–306
Role
 assignment for backend partitions, 2–45
 directions, 2–27
Rolequorum monitor, 8–32
Roles additive, 2–9
Router, 2–2
 current, 2–50
 failback, 2–50
 load balancing, 2–14
 local, 2–13
 master, 2–50
 preferred, 2–14, 2–50
 selection, 2–50
Router partition states, 5–12
Routers monitor, 8–32
Routing key, 3–1
Routing monitor, 8–33
Rscbe monitor, 8–33
RTR
 application performance, 7–4
 logging, 7–3
 SHOW, 9–271
 START, 2–1, 9–291
 STOP, 9–300
RTR\$DUMP_DIRECTORY, 2–29
RTR\$STARTUP, 2–38
RTR application performance
 analyzing, 7–4

RTR help file location, 2-29
RTR invocation, 9-194
RTR journal file, 1-1
RTR log file, 1-2
RTR monitor, 8-1
RTR_DIRECTORY, 2-29
RTR_DUMP_DIRECTORY, 2-29
RTR_FE_NOTIFICATION, 2-30
RTR_STS_CACHExHAU, 2-28

S

Screen

monitor, A-2

Script file, 1-23

SCROLL, 9-195

Secondary

active state, 2-7

site, 3-6

SEGMENT

SHOW, 9-274

Sequence numbers, 2-46, 2-48

Server, 2-2

callout, 2-12

concurrent, 2-16, 9-84

recovery, 5-1

security, B-4

shadow, 5-1

standby, 2-50

SERVER

SHOW, 9-276

Server states

backend, 5-10

SERVICEPROVIDER

CREATE, 9-89

DELETE, 9-106

MODIFY, 9-178

SHOW, 9-280

SET

ENVIRONMENT, 1-25, 9-197

FACILITY, 9-199

LINK, 9-202

LOG, 9-207

MODE, 9-211

NODE, 9-214

SET (cont'd)

PARTITION, 9-219

TRANSACTION, 9-224

Setting failover policy, 2-49

Setting quorum threshold, 9-200

Setup

dual-rail, 2-39

multihome, 2-39

Shadowing, 5-1

Shared memory, 2-23

SHOW

CHANNEL, 9-229

CLIENT, 9-231

CONNECTIONPOOL, 9-233

DATASOURCE, 9-235

DISPLAY, 9-237, A-3

ENVIRONMENT, 9-239

FACILITY, 9-240

JOURNAL, 9-245

KEY, 9-248

LINK, 9-250

LOG, 9-253

MODE, 9-255

NODE, 9-257

PARTITION, 9-260

PROCESS, 9-265

REQUESTER, 9-267

RESOURCE_MANAGER, 9-268

RM, 9-268

RTR, 9-271

SEGMENT, 9-274

SERVER, 9-276

SERVICEPROVIDER, 9-280

TRANSACTION, 9-282

VERSION, 9-287

Site

secondary, 3-6

Size of journal, 5-6

Snapshot, 7-9

Socket

not located, 2-18

Sockets, 2-28

SPAWN

DCL command, 9-288

- Stalls monitor, 8–34
- Standby
 - failback, 2–25
 - servers, 2–50
 - takeover, 2–25
- Standby set, 3–1
- Start
 - RTR, 2–1
- START
 - HTTP_SERVER, 9–290
 - RTR, 9–291
- STARTUP, 2–38
- State
 - ABORT, 4–2
 - COMMIT, 4–2
 - DONE, 4–2
 - EXCEPTION, 4–2
 - partition, 5–1
 - primary active, 2–7
 - PRI_DONE, 4–2
 - secondary active, 2–7
 - SENDING, 4–2
 - transaction, 4–1
 - transitions, 4–5, 9–227
 - VOTED, 4–2
- States
 - backend server, 5–10
 - client, 5–11
 - frontend client, 5–11
 - router partition, 5–12
- Stccalls monitor, 8–35
- STOP
 - HTTP_SERVER, 9–299
 - RTR, 9–300
- STRING
 - DISPLAY, 9–128
- Striped disks, 2–6
- Substitution symbol, A–3, A–5
- Summary monitor, 8–35
- Symbol
 - prompt, 1–3
- SYMBOLIC
 - DISPLAY, 9–134

- System mode, 9–211
- System monitor, 8–37

T

- Takeover
 - standby, 2–25
- TCP/IP protocol, 2–38
- TEXT
 - DISPLAY, 9–138
- Three strikes feature, 9–222
- Threshold
 - setting quorum, 9–200
- Throughput
 - environment variable, 2–31
- Timeout
 - transaction minimum, 9–64
- Tpslo monitor, 8–39
- Tps monitor, 8–38
- Traffic monitor, 8–39
- Transaction
 - backlog, 2–7
 - branch, 4–1
 - journal states, 4–2
 - multi-participant, 4–5
 - presentation, 3–7
 - rejected, 7–8
 - replay, 3–11
 - state changes, 4–4
 - states, 4–1
 - state transitions, 4–5, 9–227
 - throughput, 2–16
 - timeout, 9–64
- TRANSACTION
 - SET, 9–224
 - SHOW, 9–282
- Trans monitor, 8–39
- TRIM
 - FACILITY, 2–7, 9–302
- Tunnel configuration, 2–39

U

Unable to locate socket, 2-18
Unreachable hosts, 2-42
UNREGISTER
 RESOURCE_MANAGER, 9-306
 RM, 9-306
Upstream monitor, 8-40
User authentication, B-4
User credentials caching, B-5

V

V2calls monitor, 8-40
Variable
 channel, 2-32
 environment, 2-30
 journaling, 2-31
VERSION
 SHOW, 9-287
Virtual memory, 2-18

W

WAITQ limit, 2-33
WAITQ memory quota, 2-28
WAITQ size, 2-33
Web browser interface, 1-3
Wildcards, 9-240
Windows service, 2-43
Windows user logout, 1-25
Wq_facility monitor, 8-41
Wq_process monitor, 8-41

X

XA, C-1
 Commands, 9-188
 DTC Support, C-4
 Introduction, C-1
 Invoking RTR XA Support, C-2
 MONITOR XA, C-3
 REGISTER RESOURCE_MANAGER,
 9-188
 register RM, C-2

XA (cont'd)

 REGISTER RM, 9-188
 SHOW RESOURCE_MANAGER, 9-268
 SHOW RM, 9-268
 UNREGISTER RESOURCE_MANAGER,
 9-306
 UNREGISTER RM, 9-306
XA monitor, 8-42

Z

Zlib
 open source, 2-26